

COMPOUNDS AND CHEMICALS



COMPOUNDS AND CHEMICALS



DUFF POWER!

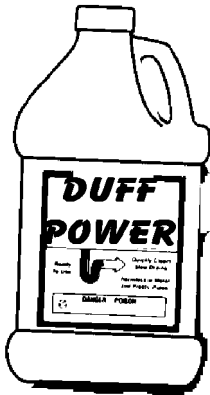
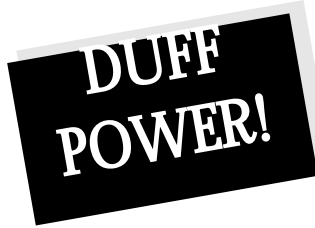

DUFF POWER - Opens clogged drains, dissolves organic matter and melts heavy grease deposits. Contains special corrosion inhibitors and won't harm piping systems, septic tanks or cesspools. FOR PROFESSIONAL USE - SEE SPECIAL NOTICE INSIDE EACH CARTON. Quart Size.

FIG. NO.	PRICE
16071	

DUFF CONDITIONER - A non-acid liquid drain cleaner for cleaning of hair, grease, paper, lint and organic matter. Ecologically safe - contains no solvents. 1 Quart.

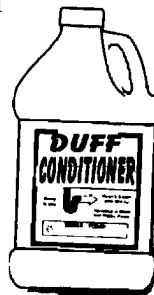

FIG. NO.	PRICE
44345	



SEPTIC TANK ACTIVATOR - Reactivates septic tanks and drainfield systems. Accelerates natural decay of organic wastes. Use every 6 months to reduce maintenance costs. 32 Oz.

FIG. NO.	PRICE
12623	

ROOT DESTROYER - Cleans roots from sewer lines and retards new growth. Use regularly to maintain. 6 LB.



FIG. NO.	PRICE
12632	



MURIATIC ACID 20% - 1 Gal. Industrial strength cleaner for tiles, brick, porcelain, masonry, toilet bowls and removes scale from metal surfaces. Made only from pure ingredients.

FIG. NO.	PRICE
16104	

CLOROBEN - PT - Dissolves grease, soap, fat and detergent. Eliminates regular grease-trap cleaning. Stops frequent septic tank and cesspool pumping. Restores soil absorption to drainfields. Opens sluggish drains and lines. Kills odors. Non-acid. Non-caustic. Harmless to digestive bacteria.

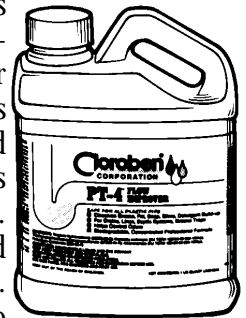

SIZE	FIG. NO.	PRICE
QUART	16067	
GALLON	16073	
15 GALLON	16076	



LIQUID ICE MACHINE CLEANER - Removes scale from ice machines and coffee urns. A food grade phosphoric acid.

FIG. NO.	PRICE
16122	



LIME SOLVENT - For professional and Industrial use. Removes lime, scale, urinary salts, plaster, rust and other mineral deposits from hot water coils, boilers, gas water heaters, cooling towers, condensers and heat exchangers. Safe for use on steel, copper, iron, bronze and lead piping. 1 Quart.

	FIG. NO.	PRICE
QUART	12685	
GALLON	25455	

PERMA-CEMENT



Concrete patching cement. Rapid setting, just add water and mix. For sidewalks, steps, driveways, etc.

	FIG. NO.	PRICE
3 LB	16085	
10 LB	16086	
50 LB	16087	

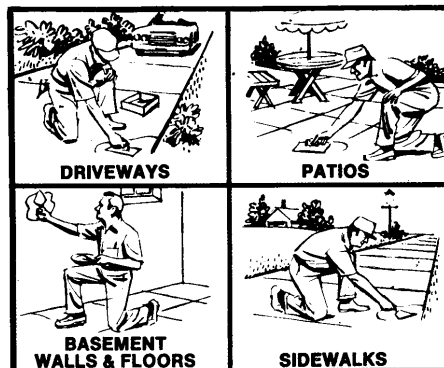

WET PLUG - Hydraulic Cement. Stops water leaks instantly. For exterior or interior use.

	FIG. NO.	PRICE
3 LB	38032	
10 LB	38033	
50 LB	38034	



SOLDERING PASTE - Self cleaning, lead free flux specially formulated for seat fitting work. Removes oxidation and prepares copper, brass, tin, stainless steel, cast and wrought iron for the proper bonding of solder to metal assuring leak-tight joints. It makes the solder flow freely and tin perfectly. It's recommended for all soft solder work, including 95/5. Meets federal specification O-F-506.

	FIG. NO.	PRICE
2 Oz	12649	
4 Oz	12650	
1 LB	12651	



PLUMBER'S PUTTY - A non-bleeding, plastic and elastic putty made especially for plumbers. It's not sticky and handles like modeling clay. It keeps indefinitely and it won't shrink, crack or crumble.

	FIG. NO.	PRICE
14 Oz	12654	
5 Lb	12656	



LACO FLUX - Soldering flux paste.

	FIG. NO.	PRICE
2 Oz.	18997	
4 Oz.	18998	
1 Lb.	18999	



NOKORODE SOLDER PASTE

	FIG. NO.	PRICE
2 Oz	16022	
1 Lb	16024	



STA-CLEAN - Stay clean soldering flux for virtually all metal other than aluminum, magnesium or titanium. Use with Stay-Brite solders, or practically any other solder with a liquids below 700oF. Not recommended for electrical or electronic applications.

	FIG. NO.	PRICE
16 Oz	18066	
4 Oz	18065	



STAINLESS STEEL FLUX

LIQUID - Will not cause progressive corrosion on stainless steel. Also may be used on copper, galvanized, iron, chrome, steel, lead, and brass.

	FIG. NO.	PRICE
4 Oz.	23833	



FORM-A-GASKET NO.1 - Fast drying, improves gasket sealing power, adds reliability to rigid or permanent assemblies. Eliminates delays. Seals and repairs a wide range of gaskets. Fills in uneven flanges, surfaces. Seals pipe fittings, air ducts, boilers, plumbing connections and threaded assemblies. Dries fast, sets hard for sealing permanent or rigid assemblies. Easy to apply. UL Listed. Approved by Bureau of Standards and appeals of NYC. Conforms to MIL-S-45190C (ORD) Type I.

	FIG. NO.	PRICE
3 Oz. Tube	32834	
11 Oz. Tube	16028	



FORM-A-GASKET NO. 3 - Improves reliability of seal on close fitting parts. Easy to use. Seals all types of solid gaskets. Dries slowly, sets to a pliable film for sealing close fitting parts, machined surfaces, and threaded connections in industrial, aircraft and marine engines. Applies easily with brush or roller. UL Listed. Approved by Bureau of Standards and Appeals of NYC. Conforms to MIL-S-45180C (ORD) Type III. 4 FL Oz.

FIG. NO.	PRICE
16032	



BLUE SILICONE GASKET - Industrial grade silicone makes gaskets and fills gaps between metal, masonry, plastics, glass, tile, rubber and fabrics. 11 Oz. tube.

FIG. NO.	PRICE
16031	



For additional information call: 610-275-4453 or Fax: 610-279-6299
Please call for current prices.



FORM-A-GASKET NO.2 - Increases reliability of gasket seal on flexible assemblies. Saves time, cuts cost. Seals and repairs gaskets on flanges, cover plates, steam lines, hose connections and threaded assemblies. Dries slowly, set to pliable film for sealing semi-permanent or flexible assemblies. Applies easily. Removable. UL Listed. Approved by Bureau of Standards and appeals of NYC. Conforms to MIL-S-45190C (ORD) Type I.

	FIG. NO.	PRICE
3 Oz Tube	37708	
11 Oz Tube	16030	

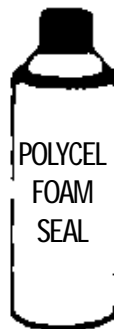

Polycel Foam Seal - Triple expanding insulates and stops drafts. Seals out air and moisture. Non-flammable propellant. Contains HCFC 22/14sb (ODC). Contains fire retardant Class 1 fire rating

FIG. NO.	PRICE
87606	

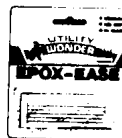

EPOX-EASE Epoxy Putty - This one-part, fast cure epoxy putty has thousands of uses. it can be sanded, painted, filed, sawed, drilled, tapped and it's a metallic gray color. 4 Ounce.

FIG. NO.	PRICE
48953	



RED HIGHT TEMP SILICONE GASKET - High temperature silicone makes gaskets that resist 600°F intermittently. Resists aging, weather, and thermal cycling without shrinking, crackling or hardening. 11 Oz. tube.

FIG. NO.	PRICE
55769	

Acrylic Latex Caulk - with silicone



FIG. NO.	PRICE
CLEAR	75924
WHITE	38561

Liquid Wrench - Loosens rust and corrosion quickly with teflon.



← 11 Oz. Spray Can

FIG. NO.	PRICE
16036	

3 Oz. Squeeze Can →



FIG. NO.	PRICE
20265	



Silicone Sealant

3 oz tube

	FIG. NO.	PRICE
WHITE	16026	
CLEAR	38847	

Silicone Rubber Sealant. 10.3 Fluid Ounces for caulk gun. Mold resistant, paintable, permanently flexible.



OEM #	FIG. NO.	PRICE
	WHITE 16025	
	CLEAR 38846	

CAULKING GUN - Ratchet type.



FIG. NO.	PRICE
12648	



Trace-A-Leak Dye - Tablets and 16 Oz liquid.

Designed for use in:

- *Tracing water leaks
- *Following water lines
- *Examining water currents

Colors Available:

- *Fluorescent Green & Red
- *Non-Flourescent Blue

	FIG. NO.	PRICE
Tablets	38196	
Liquid	47658	

Markal E-Z Break Copper Anti-Seize & Lubricating Compound.

- *Copper Based
- *Resists rust and corrosion.
- *Recommended for coating nuts, bolts, valves, flanges, spines, for easy breakout after years of service.
- *Meets Mil. Spec. Mil-A907E
- *Temperatures to 1800 degrees F.



FIG. NO.	PRICE
16097	



PENETRATING OIL - A highly effective penetrant that breaks down rust and corrosion and loosens frozen fittings. It lubricates and protects by inhibiting further corrosion and rust accumulation. 12 oz. aerosol can with spray tube.

FIG. NO.	PRICE
12633	

LUBE OIL - A special blend of oils for lubricating, electric motors, pumps and various moving parts. 8 oz.



FIG. NO.	PRICE
38073	

RECTORSEAL!



RECTORSEAL 100-W - Virgin, White teflon pipe joint compound specifically formulated for threaded connections where cleanliness, as well as positive sealing is essential. It will not stain hands, soil uniforms or leave a messy appearance. Recommended for threaded connections on lines carrying:

- Acids, LPG, Alkalis, Odorants, Anhydrous Ammonia, Oils, Brine, Petroleum gases, butane, Other Gases (EXCEPT OXYGEN), Caustics, Propane, Corrosives, Solvents, Fuels, Steam

FIG. NO.	PRICE
1/2 Pint	23974
1 Pint	23975

LEAK LOCK

Leak Lock is a soft setting pipe joint compound for threaded joints, flanged joints, gasket surfaces and mating surfaces. It is resin based brushable paste which remains permanently flexible, adheres to internal surfaces and fills voids. Excellent for use on metal and plastic materials subject to extreme vibrations, temperatures from -100F to 400F full vacuum pressures to 10000 PSI. Leak Lock seals most chemicals including all refrigerants, petroleum products, natural and manufactured gases, steam, water, air, etc. Alcohol is the solvent.



RECTORSEAL No. 5 - Yellow Pipe Joint Compound - Meets requirements of American Gas Assoc. for LP-Gas work and National Board of Fire Underwriters Pamphlet #58. Recommended for:

- Acids, Diluted; Air, Compressed Gaseous; Ammonia, Brine; Carbon Dioxide; Caustic Alkalis, Diluted; Cutting oils; Diesel Fuel Oil; Fatty Acids (Liquid); Freons (All); Gasoline; Heating Oils; Hydraulic Oils; Kerosene; Liquefied Petroleum Gases; Manufactured Gases; Nitrogen, Gaseous; Petroleum Solvents; Steamlines; Vegetable Oils; Water Gas

FIG. NO.	PRICE
1/4 Pint	16041
1/2 Pint	16042
Pint	16043
Quart	16044



FIG. NO.	PRICE
1.3 Oz	35807
4 Oz	35808
1 Pint	35809

For additional information call: 610-275-4453 or Fax: 610-279-6299
Prices are a guide only. Please call for current prices.

GASOILA®



THREAD SEALANT

Smooth non-hardening compound. Outstanding for pipe threads that may require disassembly. Insoluble in gasoline, oils, kerosene, diesel fuels, steam, water and refrigerants as well as may other acids, solvents, gases and chemicals - but not OXYGEN. AGA approved. Use on aluminum, brass, copper, iron, plastic, stainless and steel. 1 pint.

FIG. NO.	PRICE
51608	

XPANDO



Withstands deflection, high temperature, vibration. Expands and contracts with pipe movement. Will withstand all pipe pressure. Can be used in below freezing temperatures. Non-toxic. 1 Pint.

FIG. NO.	PRICE
16107	

Duff Pipe Thread Compound

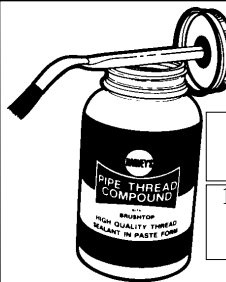

FIG. NO.	PRICE
1/2 Pint	12625
1 Pint	12626

LA-CO Lic-Tite Paste with Teflon.

- * Heavy Duty
- * Non-Toxic, non-drying, anti-seize.
- * Certified by AGA and NSF
- * Use on metal and PVC, ABC and CPVC pipe thread connections.
- * Contains more teflon for greater sealing power.
- * Classified by UL in USA and Canada.
- * For use with water, air, natural gas, LP gas, steam, gasoline, oil and refrigerants.
- * Washes off hand and clothing easily.
- * Pressures to 10,000 PSI-liquid; to 3,000 PSI-gas.
- * Temperature range: -50 Deg. F. to +500 Deg. F.



SIZE	FIG. NO.	PRICE
1/2 Pint	16056	
1 Pint	16057	

PREMIUM TEFLON TAPES

YELLOW

GREEN

GRAY

**INDUSTRIAL
WHITE**



GAS



OXYGEN



STAINLESS



INDUSTRIAL

Thicker with more teflon density than regular teflon tapes
 Color coded for specific applications Meets or exceeds MIL SPEC T-27730A
 Can withstand temperatures of -450°F and +550°F

YELLOW GAS LINE TEFLON THREAD SEAL TAPE	Designed for gas lines of all types...natural gas, propane and butane lines. Meets gas company standards world wide. Full density (1.6) and also 4 mils thick, makes this the heaviest tape available. Seals threads easily and quickly with confidence. Has a temperature range of -450F to +550F. Exceeds Mil Spec, T-27730A. UL listed.
GREEN OXYGEN TEFLON THREAD SEAL TAPE	Color coded green for oxygen applications. Grease free, density of 1.2 and 4 mils thick. This is the tape for all your oxygen lines. Will not support combustion. Temperature range of 450F to +550 F. Exceeds Mil Spec. T-27730A. UL listed.
GRAY STAINLESS STEEL TEFLON THREAD SEAL TAPE	This tape has nickel pigment color added for use on all stainless steel fittings. Prevents galling, seizing or corrosion. At 4 mils thick and a high density rates, this is the tape for coarse stainless steel threads. Also carries a temperature range of -450F to +550F. Exceeds Mil. Spec. T-27730A. UL Listed.
WHITE PREMIUM HIGH DENSITY THREAD SEAL TAPE	For all industrial applications. Made from 100% Virgin Teflon PTFE. No pigments, no additives. May be used on all applications including water, oil, chemical, medical and food processing where non-contamination standards are high. exceeds Mil. spec T-27730a. Temperature range of -450F to +550F. You will feel the difference from all other regular thread seal tapes.

YELLOW			
FIG. NO.	SIZE	LENGTH	PRICE
61358	1/2"	260	

GREEN			
FIG. NO.	SIZE	LENGTH	PRICE
61359	1/2"	260	

GRAY			
FIG. NO.	SIZE	LENGTH	PRICE
61360	1/2"	260	

INDUSTRIAL WHITE			
FIG. NO.	SIZE	LENGTH	PRICE
61362	1/2"	260	

PLUMBER'S PASTE - Ideal for repairing hairline cracks and leaks and resetting tiles, fixtures and porcelain chips. Easy 1-to-1 mix spreads easily in thin film, achieving an outstanding sealing effect. Bonds, seals, fills. Adheres to basically the same materials as Plumber Seal.



	FIG. NO.	PRICE
SMALL	16094	
1 LB	16090	



PLUMBER SEAL - Stops most leaks without draining. Packaged in convenient economy cartridges, Plumber Seal mixes like putty, hardens like steel, with easy 1-to-1 mix. Repairs pipes, tubs, tanks, fittings and fixtures. Bonds to steel, aluminum, copper, brass, plaster, brick, concrete, wood and ceramics. Cures under water.

	FIG. NO.	PRICE
SMALL	16092	
1 LB	16089	

SCRUBS Hand Cleaner Towels



SCRUBS hand cleaner towels - Heavy duty hand cleaning, anywhere, anyplace, anytime! SCRUBS in a bucket provide pleasant smelling removal of heavy grease, lubricants, adhesives, oils, tar, asphalt, inks, wax and many other difficult to remove soils such as coal dust, graphite and grass stains. And, where these soils are absorbed into the patented SCRUBS towels, they DO NOT re-transfer back onto the skin!

FIG. NO.	PRICE
50952	

COPPER BRITE - Instant cleaner, eliminates cleaning of copper

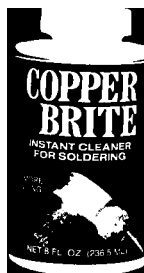
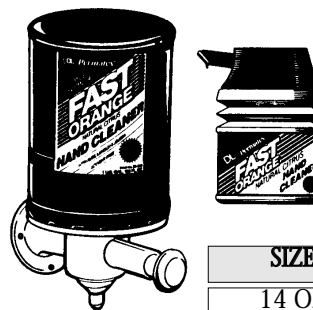
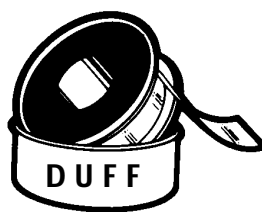

FIG. NO.	PRICE
38945	



Fast Orange Hand Cleaner - Original formula. Quickly removes deeply embedded grease, oil, dirt and most stubborn soil. Contains lanolin and other soothing emollients to help condition hands against drying, cracking and chapping.

SIZE	FIG. NO.	PRICE
14 OZ	43715	
1 GALLON	58087	



Teflon Tape - Inert, non-toxic, easy to use tape for use on all threaded connections as a pipe dope. It withstands pressures to 10,000 PSI and conforms to MIL-T-27730A. Made of DuPont Teflon.

	FIG. NO.	PRICE
1/2 X 520"	13201	
3/4 x 520"	13217	
1 X 520"	13226	

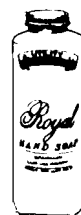

ROYAL POWDERED HAND SOAP

Industrial strength abrasive powder to remove all types of soil. 1 Lb.

FIG. NO.	PRICE
38663	

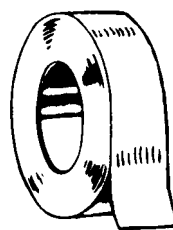

PERMACEL TAPE

For use on threaded joints of metal pipe (not exceeding 1 1/2" pipe size) in assemblies handling gasoline and petroleum oils.

SIZE	FIG. NO.	PRICE
1/2X520	18486	
3/4X520	40017	

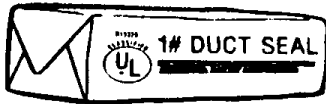

DUCT SEAL COMPOUND

Seals around J-boxes, flashings, service entries and more
 Easy to use, forms around irregular surfaces and configurations
 Resists cracking, drying, shrinking
 Cuts and trims easily and can be painted immediately after application
 20; F working temp: -40°F to 250°F service temp.

FIG. NO.	PRICE
1 lb	52596
5 lb	49003



ROOF FLASHING CEMENT

An elastic, black fibre cement for repairing around vent pipes, chimney, etc. Provides weather-proofing around new or old flashings. 1 Gallon

FIG. NO.	PRICE
12658	



LEAK DETECTOR

Use to detect leaks in joints on any kind of gas pipeline, especially refrigerants. An extremely active foaming agent. 1/4 pint.

FIG. NO.	PRICE
12642	



HEATPROOF GREASE

For stems, valves, etc.

WILL NOT MELT.
2.5 Ounce

FIG. NO.	PRICE
51486	

NU-CLEAR THREAD CUTTING OIL

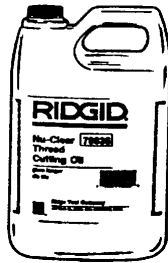

FIG. NO.	PRICE
QT	34615
GAL	30336
5 GAL	30460
55 GAL	34617

DARK THREAD OIL

FIG. NO.	PRICE
QT	34615
GAL	30336
5 GAL	30460
55 GAL	34617



CONTACT BURNISHER COMPOUND

Cleans contacts on controls and removes grease and oxide films from all metals. It's perfect for use on oil burners, gas, air-conditioning, switches and electronic controls. Includes spray tube. 1 quart.

FIG. NO.	PRICE
50861	



CIRCULATOR OIL

Hydronic circulator oil-1 gallon pump.

FIG. NO.	PRICE
45273	



DARK THREAD CUTTING OIL

Sulphur base
 May be used on iron, steel, stainless steel and other metal material
 350°F flash point

FIG. NO.	PRICE
1 QT	12681
1 GAL	12682



SLUDGE KLEEN

Sludge solvent and fuel oil conditioner. For all grades of fuel oil to reduce soot formation. Keeps nozzles from clogging and disperses sludge and moisture. Increase fuel oil combustion efficiency! 1 Quart.

FIG. NO.	PRICE
48417	



DOW #7 LUBRICANT

5.3 Oz. tube.
 Non-Hardening
 -40°F to 400°F. Contains Silicone. Environmentally Safe!

FIG. NO.	PRICE
23542	



DOW #111 HEAVY LUBRICANT

HEAVY DUTY 5.3 Oz. tube. Non-Hardening
 -40°F to 400°F
 Contains Silicone. Environmentally Safe!

FIG. NO.	PRICE
52516	

PIPE PROTECTION TAPE

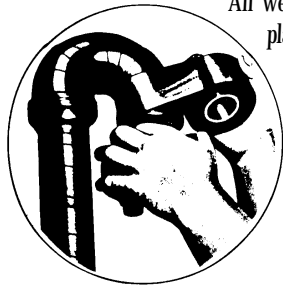

All weather pipe protection tape is a tough PVC plastic tape with special high tack adhesives formulated to resist corrosion. Provides positive protection against abrasion and corrosive action for steel pipe, fittings, electrical conduit systems and gas lines. 100' roll.

FIG. NO.	WIDTH	THICK	PRICE
82344	2"	10 mil	
74557	2"	20 mil	

PIPE WRAP PRIMER



Quick drying rubber base primer that permeates pits and irregularities on the pipe surface and prepares the metal for tape application. Quart Size.

FIG. NO.	PRICE
45481	

WD-40



Penetrates deep to free up frozen or rusted metal parts and fasteners
 Displaces moisture: use it to dry out electrical and electronic equipment
 Stops squeaks
 Cleans: removes grease and road tar
 Will not harm paint, plastics, rubber or fabrics Does not contain silicones
 9 oz.

THE ORIGINAL TROUBLESHOOTER!

FIG. NO.	PRICE
30018	

SNOOP

Liquid leak detector



SNOOP liquid leak detector with the "snooper" tube to detect any type gas leak even in hard to reach areas in industrial and residential applications - air, natural gas, propane, helium, acetylene, nitrogen, oxygen.

FEATURES

Non-toxic-pure, Non-flammable, No residue-dries clean, will not collect dust, no chlorine or halogen additives, bubbles indicate size of leak, detect leaks on vertical surfaces, virtually odorless, extendible SNOOPER tube for use in hard to reach areas, safe, positive leak detection.

SIZE	FIG. NO.	PRICE
8 OZ.	16062	



CALGON THERMO-TRAP HEAT ABSORBING PASTE

Thermo-Trap is a heat absorbing paste to protect valves or controls from damage by heat when doing soldering, or welding or brazing near these heat sensitive parts.

FIG. NO.	PRICE
16144	

PIPE GASKET LUBE

For soil pipe gaskets, and all gasketed pipe. 1 Quart.



FIG. NO.	PRICE
7496	

ENFORCER WASP & HORNET KILLER



Shoots a 20 ft. blast
 Instant knockdown
 Quick kill
 Non-conductive to 37,000 volts
 16 Oz. spray can

FIG. NO.	PRICE
50869	



MICROMET

A slowly soluble food-grade hexametaphosphate product that is safe for use in drinking water supplies. For preventing red iron water problems, lime scale and controlling corrosion (rust). 5 lb.

FIG. NO.	PRICE
16126	



IRON OUT

Chemically changes iron oxide (rust) into a clear, soluble state that will easily flush away.

Removes rust and stains from water softeners, toilets, sinks/tubs, white clothes and dishwashers.



SIZE	FIG. NO.	PRICE
18 Oz.	9302	
5 Lb.	9303	

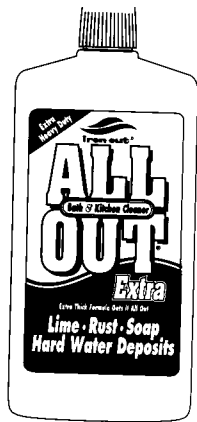

ALL OUT

Extra heavy duty - safely cleans lime, rust, soap and hard water deposits! 1 1/2 Pint.

FIG. NO.	PRICE
47832	

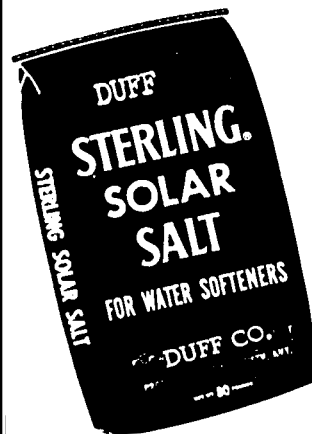

SOLAR SALT

DESCR.	FIG. NO.	PRICE
Solar Salt 50 Lb.	9304	
Solar Salt 80 Lb.	9301	
Pellet Salt 50 Lb.	46832	
Red Out Salt 40 Lb.	47517	
Rock Salt 80 Lb.	50865	
Rock Salt 50 Lb.	50864	



FURNACE CEMENT - For temperatures up to 1800 Degrees F. For sealing and patching hot surfaces.

	FIG. NO.	PRICE
1 LB	24842	
1/2 GAL	12674	
1 GAL	12675	



FOOD GRADE SILICONE - A multi-purpose product that lubricates water-proofs and protects surfaces while being odorless, colorless and tasteless. USDA NO. H-1

FIG. NO.	PRICE
63804	

SOIL SEAL - Pre-mixed perfect seal for soil pipe joints. Hardens quickly. Can be used as a cold solder on waste lines carrying low pressure water, steam, gas and oil.



SIZE	FIG. NO.	PRICE
22 OZ	12662	
10 OZ	12660	



INSULSAFE NON-ASBESTOS INSULATING CEMENT

SIZE	FIG. NO.	PRICE
50 LB	14141	
5 LB	14140	

SILVERKING



"Hydronic" Formula No. 5 - with silicone sk-471. Will reduce fuel consumption in Hot Water Systems up to 20% by more efficient boiler operation. Waste of energy and pollution are greatly reduced. Lubricates metal plastic and rubber parts and protects entire internal system against fouling - contains no petroleum.

GUARANTEE

- * Removes sludge - frees and lubricates zone valves.
- * Protects the pump by lubricating the seal.
- * Removes insulating sludge on submerged coils.
- * Prevents clogging of automatic (hot water) Valves.
- * Frees and lubricates stuck flow valves.

FIG. NO.	PRICE
16047	

ALL BRASS FORCE & SUCTION PUMP

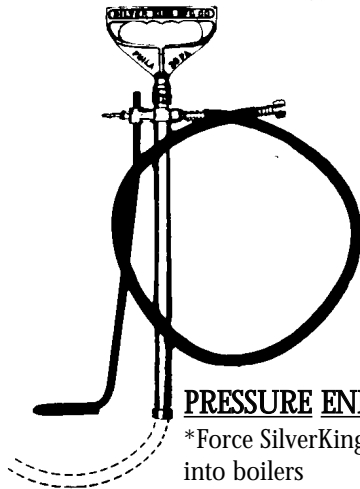

PRESSURE END

- * Force SilverKing into boilers through draw off
- * Open clogged drains
- * Test radiant heat
- * Open clogged fuel lines
- * Sprays insecticides
- * Test soil pipe

SUCTION END

- * Draw sludge or water from fuel oil tanks
- * Empties toilets and traps
- * Drains plumbing fixtures
- * Use it as a Bilge pump

	FIG. NO.	PRICE
Pump	16051	
Hose Only	16052	



QUICK cleaner and inhibitor with anti foam silicone sk-24 guaranteed to stop boiler surge INSTANTLY. For high and low pressure steam boilers. Use 1 can for each 150,000 BUT's of boiler rating. Will reduce fuel consumption in steam heating systems up to 30% by more efficient boiler operation. Waste of energy and pollution are greatly reduced.

FIG. NO.	PRICE
16046	

SAFE BOILER STOP LEAK

with Anti Foam Silicone SK-24

SILVER KING SILICONE SK-24 - THE GREATEST IMPROVEMENT EVER DEVELOPED IN STOP LEAK CHEMICALS FOR STEEL AND CAST IRON BOILERS. WILL NOT SURGE - WILL NOT SLUDGE - WILL NOT CLOG.

Silver King stop leak compounds are scientifically formulated to insure a water insoluble seal in steam boilers and throughout entire hot water systems, including leaks in copper lines, radiators, and radiant heat. Also recommended for auto cooling systems.

The Silver King force and suction pump (FIG. NO. 16051) completes the job in minutes.

Guaranteed to stop all leaks in radiant heating systems.

Recommended for both high and low pressure boilers.



powder



liquid

FIG. NO.	PRICE	FIG. NO.	PRICE
16049		16048	

SPEEDY INJECTOR GUN

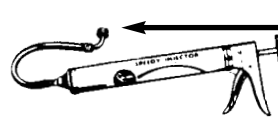

garden hose thread

injects boiler chemicals into boilers without shutting down system.

FIG. NO.	PRICE
61457	



Gallon.

NO FREEZE 30 - Low temperature heat transfer to protect hot water heating systems from freeze-ups. Excellent for summer homes, RV's, solar collectors, marinas, etc. Can withstand temperatures of 350 Deg. F. over extended period and normal make-up water. Odorless, safe. One

FIG. NO.	PRICE
12687	



VIKING COIL CLEANER - An efficient inhibited acid for removal of scale, lime, rust, calcium, iron, etc. For coils, water heaters, urinals, heating and air conditioning equipment. One Gallon

FIG. NO.	PRICE
16099	

SOOT SCOOT - Toss-in duo-pac eliminates soot in combustion chambers for more efficient performance. Easy to use. No mess.

FIG. NO.	PRICE
12667	



HYDRO ZORB - Fuel Tank Water Absorber. Clears up problems caused by freezing. Will absorb twice its weight in water. Inhibits corrosion as it breaks down deposits of sludge and gums. Serves as an anti-freeze compound to prevent future freezeups. Quart Size.

FIG. NO.	PRICE
30917	

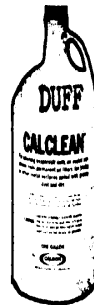

CALCLEAN DETERGENT - Heavy duty liquid cleaner for spray cleaning evaporator coils. Air cooled condenser coils, metal filters, fan blades and other surfaces soiled with greasy dust and dirt. Will not corrode any metal when used as directed. Also cleans pots, pans, floors, woodwork, etc. 4 Liter.

FIG. NO.	PRICE
16167	



WATER FINDING PASTE 2.4 Oz. Detects water in oil or gasoline tanks.

FIG. NO.	PRICE
16035	

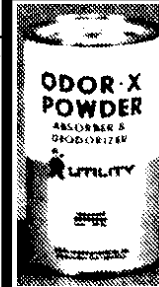

ODOR-X POWDER - An easy to use powder. Just sprinkle on oil spills - removes both the stain and the odor. 1 LB can.

FIG. NO.	PRICE
12670	



OIL DRY a pre-treated absorbent eliminates odors as it absorbs oil, grease and liquid spills. It's non-flammable and easy to use. 25 LB. Bag.

FIG. NO.	PRICE
49291	



HOT 4 IN 1 HEATING OIL TREATMENT - Concentrate. Totally disperses water Promotes clean flame Controls waxing and gelling Prevents corrosion Cleans pump and filter Reduces smoke Cleans burner tips Eliminates "varnish" Eliminates soot 16 Oz.

FIG. NO.	PRICE
49716	



INSTANT GALVANIZE Fuses the zinc component to the base metal. Corrosion will attack only the outer zinc coating leaving the metal protected RUST FREE.

FIG. NO.	PRICE
18255	

