

DUFF

PLUMBING & HEATING SUPPLIES
WATER TREATMENT EQUIPMENT
INDUSTRIAL SUPPLIES & PUMPS

610-275-4453

fax: 610-279-6299



Fourth Generation.
Since 1947

DWC

PRODUCTS FOR QUALITY WATER

DUFF DIFFERS

Find out why our customers say, "Duff Differs"

- * Duff offers the widest selection of products in our industry. From plumbing, heating and industrial supplies, to pumps, steam specialties and water treatment equipment, no one equals our vast product line.
- * Duff provides unsurpassed technical ability, with full time experts devoted to their specific fields.
- * Emergency service is available 24 hours a day, 365 days a year.
- * Duff is family owned and managed, an owner is always available to meet or talk with you, and;
- * All of this is brought to you at competitive prices!

Geoffrey and Dick Duffine

DUFF COMPANY
201 East Lafayette Street
P. O. Box 618
Norristown, PA 19401

610-275-4453

OUTSIDE PA: 800-967-DUFF (3833)

SALES FAX: 610-279-6299

WATER TREATMENT FAX: 610-275-8704

ACCOUNTING FAX: 610-275-6761

NIGHT-WEEKEND EMERGENCY NUMBERS:

610-275-2484

610-279-7860

610-275-9221

215-409-5621

215-646-0792

TERMS AND CONDITIONS

PRICES: All prices subject to change without notice.

TERMS: Payment terms are NET 10 days following month of sale.

A service charge of 2% per month will be charged on all past due invoices.

FREIGHT: All orders are shipped F.O.B. shipping point, Norristown, Pennsylvania.

ILLUSTRATIONS AND SPECIFICATIONS:

Designs, dimensions, specifications, etc. as shown in this catalog are subject to change without notice.

Duff Company will not be liable for any inaccuracies therein or variances.

GENERAL: Placement of an order with our company is a binding agreement to our terms and conditions. We reserve the right to correct clerical errors in quotations, orders, invoices and other documents. The foregoing constitutes all of our terms and conditions of sale and we make no other agreement, presentation, or warranty, express or implied.

TABLE OF CONTENTS

| | |
|---|-----------------|
| VALVES | Page 1 |
| Plumbing, Industrial, Ball, Butterfly, Gate, Globe, Check, Stainless, Flanged, Plug, Float, Solenoid and Boiler Valves. Hydrants, Floats, Petcocks and Needle Valves. | |
| FITTINGS, PIPE AND TUBING | Page 43 |
| Malleable, Cast Iron, Chrome Plated, Steel, Stainless, Forged Steel, Brass and Copper Fittings, Flanges, Nipples, Tubing and Pipe. Gaskets, Packing, Dresser Couplings and Clamps, Culvert, Gas Pipe and Fittings. Fernco Couplings, Cast Iron Specialties, Strainers, Tubing Fittings. | |
| HANGERS AND FASTENERS | Page 125 |
| Pipe and Tubing Hangers, Clamps, Rod, Anchors, Nuts, Angle Iron and Strut. | |
| FIRE PROTECTION | Page 141 |
| Valves, Sprinklers, Fire Stops, Grooved Fittings, Hose and Nozzles. | |
| PLUMBING | Page 155 |
| T&S Brass, Central Brass, Powers Valves, Symmons, Moen and Delta Faucets and parts. Commercial Drains. Sloan Valves, Parts and Optima Faucets. Tubular Traps, Supplies, Sinks, Commercial China, Toilet Repairs, Partitions, Washroom Accessories, Showers and Heads, Water Coolers and Fountains, Emergency Equipment and Garbage Disposers. | |
| HEATING AND STEAM | Page 267 |
| Tube Bundles and Coils, Water Heaters, Boilers, Unit Heaters, Controls, Circulator Pumps, Dielectric Fittings, Relief Valves, Regulators, Vents, Thermometers, Boiler Trim, Gauges, Steam Traps, Condensate Pumps, Duct, Heat Tape, Insulation and Oil Tanks. | |
| WATER REGULATORS, BACKFLOW PREVENTERS AND METERS | Page 353 |
| Pressure Reducing Valves, Backflow Preventers, Flow Controls, Meters and Shock Suppressors. | |
| PUMPS | Page 371 |
| Sump, Utility, Laundry Tray, Sewage and Effluent, Chemical Transfer, Diaphragm, Centrifugal, Pool, Industrial, Pressure Booster, Environmental and Well Pumps. Controls, Seals, Cable, Switches, Accessories, Poly Pipe, Insert Fittings and Tanks. | |
| ENVIRONMENTAL | Page 439 |
| Grundfos Pumps, Monitoring Well Accessories and Environmental Pipe, Oil Water Separators, Carbon Drums, Geotextiles, Drain Pipe, HDPE, Filtration and Emergency Equipment. | |
| WATER TREATMENT | Page 469 |
| Cartridge Filters and Housings, Softeners, Filters, Media, Control Valves and Parts, Tanks, Resin, Chemical Feed Pumps and Systems, Mixers, Chemicals, UV Lights, Reverse Osmosis, Qest Pipe, Tube Fittings and Radon Aeration Systems. | |
| PLASTIC AND HOSE | Page 579 |
| PVC, CPVC, SDR-35, Polyethylene, Sewer and Drain and Corrugated Pipe, Valves and Fittings. Laboratory Fixtures and Trim, Grating, Hose, Nozzles, Tubing, Air Filters, Regulators and Lubricators and Quick Connects. | |
| TOOLS | Page 627 |
| Milwaukee and Ridgid Power and Hand Tools and Accessories. Taps, Drills, Tubing Tools, Dies, Threaders, Cutters, Wrenches, Machines, Saws, Shovels, Tapes, Soldering Tools, Material Handling Equipment, Drain Cleaners, Van Racks and Electrical Testers and Tools. | |
| COMPOUNDS AND CHEMICALS | Page 719 |
| Drain Cleaner, Acid, Patching Cement, Flux, Putty, Caulk, Cutting Oil, Pipe Joint Compound, Teflon Tapes, Hand Cleaner, Lubricants, Boiler and Heating Compounds. | |
| INDEX | Page 733 |

REFERENCE GUIDES

| | |
|--|---------|
| <i>How to select valves for your service</i> | 9 |
| <i>Flow characteristics and resistance</i> | 10 |
| <i>Valve installation tips</i> | 11 |
| <i>Face to face dimensions of flanged iron valves</i> | 23 |
| <i>Butterfly valves</i> | 26 |
| <i>Types of solenoid valves</i> | 28-29 |
| <i>Forged steel valves</i> | 36-37 |
| <i>REAL piping specifications</i> | 54 |
| <i>Flange and bolting dimensions</i> | 61 |
| <i>Pipe weights and wall thicknesses</i> | 62 |
| <i>Pipe outside diameter guide</i> | 64 |
| <i>Selection and application of forged steel flanges</i> | 76 |
| <i>Copper tubing specifications</i> | 84 |
| <i>Actual outside diameter of tubing</i> | 85 |
| <i>Distinguishing right and left hand closet bends</i> | 105 |
| <i>Measuring cleanout plugs</i> | 109 |
| <i>Strainer screens: perforations and mesh</i> | 114 |
| <i>Spacing of hangers for pipe</i> | 136 |
| <i>Weight per linear foot for pipe and water</i> | 140 |
| <i>Drill sizes for pipe taps</i> | 140 |
| <i>Tap and drill sizes</i> | 140 |
| <i>Troubleshooting and maintaining Sloan valves</i> | 194 |
| <i>O-Rings full scale drawing</i> | 260 |
| <i>Commercial water heater sizing checklist</i> | 277 |
| <i>Conversion chart</i> | 351 |
| <i>OHMS law equation wheel</i> | 351 |
| <i>BTU & orifice size guide</i> | 351 |
| <i>Piping guide for mixing valves</i> | 352 |
| <i>Sump pump installation guide</i> | 375 |
| <i>How to select the correct submersible pumping equipment</i> | 399 |
| <i>Basic submersible pump installation</i> | 400 |
| <i>How a jet pump works</i> | 412 |
| <i>Wire selection chart for submersible motors</i> | 418 |
| <i>Typical carbon filter installations</i> | 457 |
| <i>Environmental terms glossary</i> | 465-468 |
| <i>Clearly great water throughout your home</i> | 471 |
| <i>DWC products for quality water</i> | 491 |
| <i>Sizing water softeners/filters</i> | 492-494 |
| <i>Automatic backwashing filters</i> | 496 |
| <i>Filter applications</i> | 501 |
| <i>Filtration media</i> | 502-503 |
| <i>Commercial water softeners</i> | 504-505 |
| <i>Selecting tank jackets</i> | 532 |
| <i>Resin comparisons</i> | 540-541 |
| <i>Chemical feed pump - cooling water treatment</i> | 549-550 |
| <i>Retention tank/chemical feed pump installation</i> | 563 |
| <i>Ultraviolet water equipment</i> | 565 |
| <i>Reverse osmosis</i> | 568 |
| <i>Temperature conversion chart</i> | 578 |
| <i>PVC pipe engineering data</i> | 609 |
| <i>Chemical resistance guide</i> | 620-622 |
| <i>Power drain cleaner comparison chart</i> | 705 |

VALVES

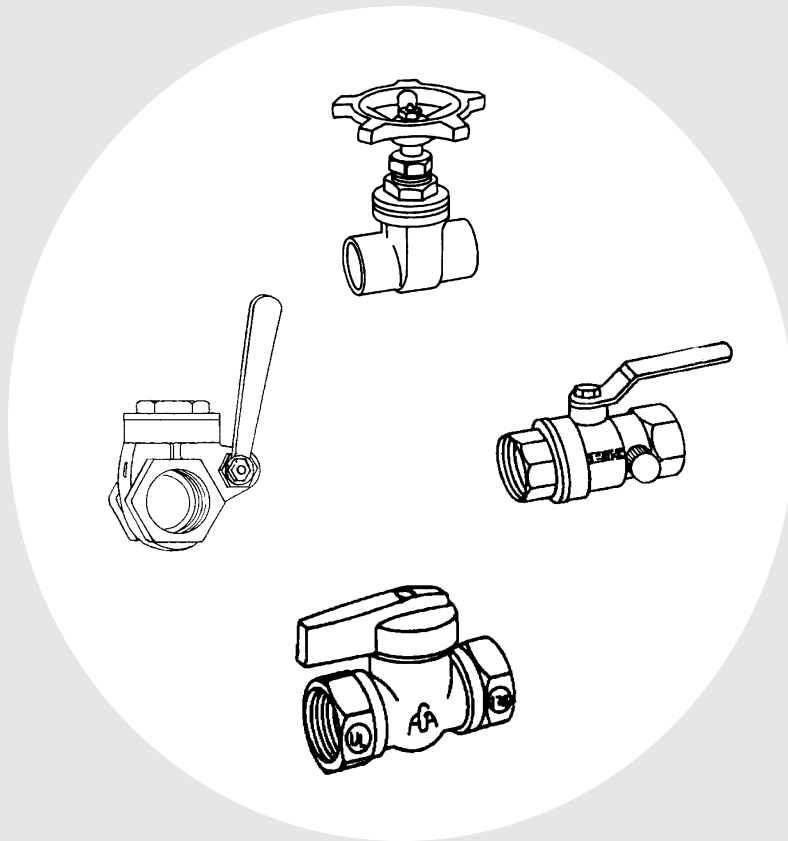

VALVES

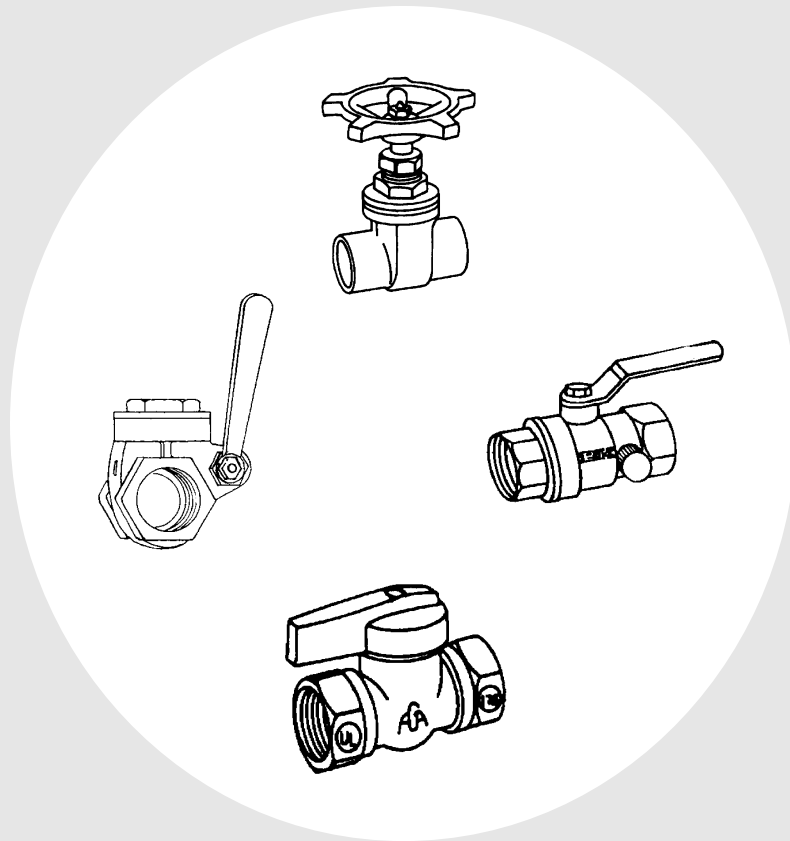

PLUMBING VALVES

STOP AND WASTE VALVES

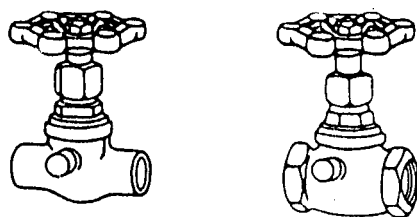

| STANDARD PATTERN | | | | |
|------------------|----------|-------|----------|-------|
| SIZE | SWEAT | | THREADED | |
| | FIG. NO. | PRICE | FIG. NO. | PRICE |
| 3/8 | 5853 | | - | |
| 1/2 | 5857 | | 5798 | |
| 3/4 | 5995 | | 5800 | |



COMPRESSION STOP AND WASTE VALVES

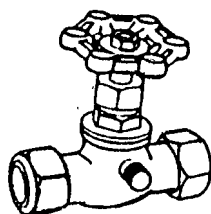

- ~ Sweat to Copper
- ~ Compression to Copper
- ~ CPVC to CPVC

GREAT if you can't use an open flame or don't want to solder!

| SIZE | FIG. NO. | PRICE |
|------|----------|-------|
| 1/2 | 6031 | |
| 3/4 | 6032 | |

STOP VALVES

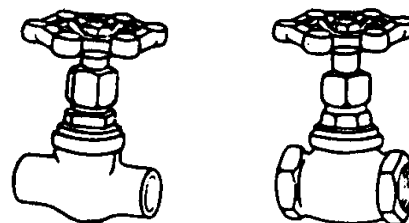

| SIZE | SWEAT | | THREADED | |
|------|----------|-------|----------|-------|
| | FIG. NO. | PRICE | FIG. NO. | PRICE |
| 1/2 | 5795 | | 5790 | |
| 3/4 | 5796 | | 5792 | |

ANGLE STOP VALVES



| SIZE | SWEAT | | THREAD | |
|------|----------|-------|----------|-------|
| | FIG. NO. | PRICE | FIG. NO. | PRICE |
| 1/2 | 6005 | | 6000 | |
| 3/4 | 6007 | | 6002 | |

STOP AND WASTE CAPS

| SIZE | FIG. NO. | PRICE |
|------|----------|-------|
| 5/16 | 6201 | |
| 3/8 | 44411 | |

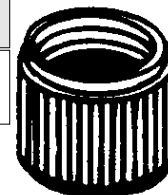

BOILER DRAINS

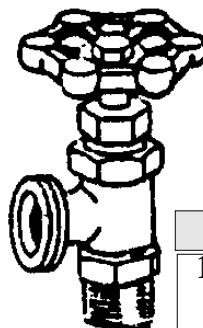

STANDARD PATTERN

| SIZE | FIG NO | PRICE |
|----------------|--------|-------|
| 1/2" SWT X MIP | 6015 | |
| 3/4" MIP | 6018 | |

MORE PLUMBING VALVES

TILE STOP



Available sweat or threaded for installation on tile walls

NEEDLE VALVE



| SIZE | FIG | PRICE |
|------|------|-------|
| 1/8 | 6556 | |
| 1/4 | 6558 | |
| 3/8 | 6549 | |

LONG STEM VALVE



Perfect for hard to reach spots. Available threaded or sweat

| SIZE | FIG | PRICE |
|------|------|-------|
| 1/2 | 6704 | |

ANGLE NEEDLE VALVE



Rated 250WOG

WATER SERVICE VALVES



FLARE CURB STOP

| SIZE | FIG NO | PRICE |
|-------|--------|-------|
| 1/2 | 6731 | |
| 3/4 | 6732 | |
| 1 | 6733 | |
| 1 1/4 | 6734 | |
| 1 1/2 | 6735 | |
| 2 | 6736 | |

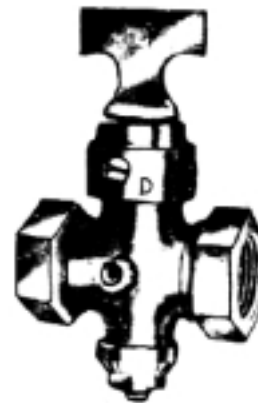

GROUND KEY STOP AND WASTE

| SIZE | FIG NO | PRICE |
|-------|--------|-------|
| 1/2 | 6740 | |
| 3/4 | 6741 | |
| 1 | 6742 | |
| 1 1/4 | 6743 | |
| 1 1/2 | 38583 | |
| 2 | 38582 | |

COMPACT PATTERN BRONZE VALVES
PROVIDING AN ECONOMICAL ALTERNATIVE TO STANDARD PATTERN VALVES!

GATE VALVES

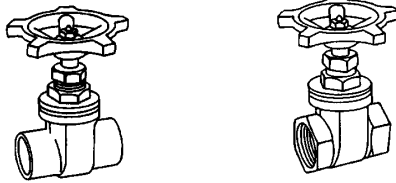

| SIZE | SWEAT | | THREADED | |
|-------|----------|-------|----------|-------|
| | FIG. NO. | PRICE | FIG. NO. | PRICE |
| 1/2 | 6761 | | 6752 | |
| 3/4 | 6762 | | 6753 | |
| 1 | 6763 | | 6754 | |
| 1 1/4 | 6764 | | 6755 | |
| 1 1/2 | 6765 | | 6756 | |
| 2 | 6766 | | 6757 | |
| 2 1/2 | 6767 | | 6758 | |
| 3 | 6768 | | 6759 | |
| 4 | | | 6760 | |

CHECK VALVES

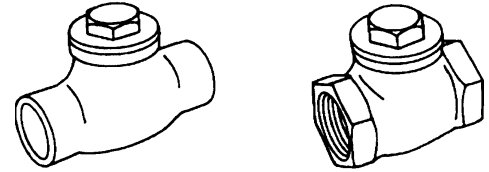

| SIZE | SWEAT | | THREADED | |
|-------|----------|-------|----------|-------|
| | FIG. NO. | PRICE | FIG. NO. | PRICE |
| 1/2 | 6780 | | 6771 | |
| 3/4 | 6781 | | 6772 | |
| 1 | 6782 | | 6773 | |
| 1 1/4 | 6783 | | 6774 | |
| 1 1/2 | 6784 | | 6775 | |
| 2 | 6785 | | 6776 | |
| 2 1/2 | 6786 | | 6777 | |
| 3 | 6787 | | 6778 | |
| 4 | 6788 | | 6779 | |

COMPACT PATTERN BALL VALVES

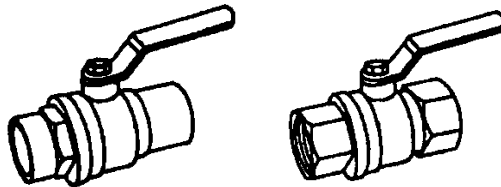

| SIZE | SWEAT | | THREADED | |
|-------|----------|-------|----------|-------|
| | FIG. NO. | PRICE | FIG. NO. | PRICE |
| 1/2 | 4163 | | 4168 | |
| 3/4 | 4167 | | 4169 | |
| 1 | 21204 | | 22734 | |
| 1 1/4 | 38834 | | 38837 | |
| 1 1/2 | 38835 | | 38838 | |
| 2 | 38836 | | 38839 | |
| 2 1/2 | 4170 | | 4172 | |
| 3 | 4171 | | 4173 | |
| 4 | 47421 | | 4174 | |

COMPACT STOP AND WASTE VALVES

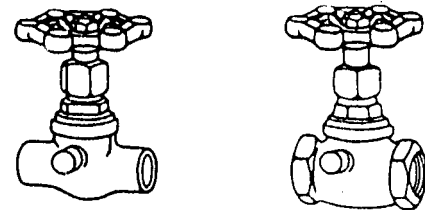

| SIZE | SWEAT | | THREADED | |
|------|----------|-------|----------|-------|
| | FIG. NO. | PRICE | FIG. NO. | PRICE |
| 1/2 | 6206 | | 6228 | |
| 3/4 | 6227 | | 6229 | |

COMPACT FROSTPROOF SILLCOCKS

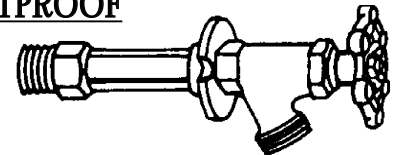

| SIZE | FIG | PRICE |
|------|-------|-------|
| 6" | 41945 | |
| 8" | 41946 | |
| 10" | 41947 | |
| 12" | 41948 | |
| 14" | 41949 | |

*All 1/2" SWT X MIP

COMPACT BOILER DRAINS

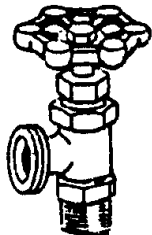

| SIZE | FIG | PRICE |
|------|------|-------|
| 1/2 | 6230 | |
| 3/4 | 6231 | |

**** IDEAL FOR PUMP INSTALLATIONS, RESIDENTIAL PLUMBING AND HEATING JOBS! ****

OUTSIDE FAUCETS

SILLCOCKS



| SIZE | SWEAT | | THREAD | |
|------|----------|-------|----------|-------|
| | FIG. NO. | PRICE | FIG. NO. | PRICE |
| 1/2 | 6011 | | 6008 | |
| 3/4 | 6013 | | 6010 | |

FROSTPROOF HYDRANTS

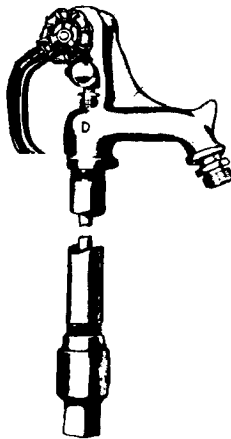

| BURY SIZE | APPROX OVERALL LENGTH | FIG. NO. | PRICE |
|-----------|-----------------------|----------|-------|
| 2' | 5' | 25449 | |
| 3' | 6' | 5304 | |
| 4' | 7' | 5306 | |
| 5' | 8' | 18460 | |

HOSE BIBBS

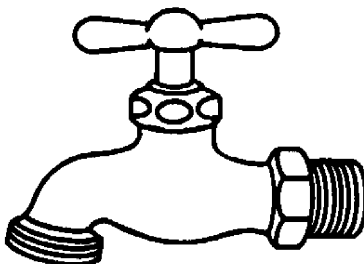

| SIZE | ROUGH BRASS | | CHROME PLATED | |
|------|-------------|-------|---------------|-------|
| | FIG. NO. | PRICE | FIG. NO. | PRICE |
| 1/2 | 20316 | | 22467 | |
| 3/4 | 20317 | | 23799 | |

FROST PROOF SILLCOCKS

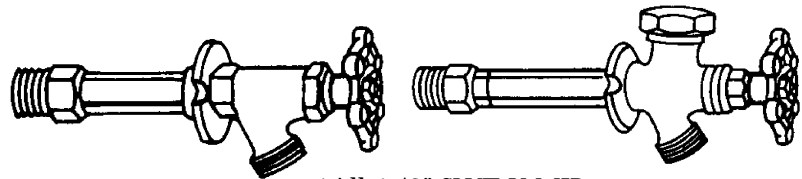

*All 1/2" SWT X MIP

| LENGTH | REGULAR PATTERN | | ANTI-SYPHON PATTERN | |
|--------|-----------------|-------|---------------------|-------|
| | FIG. NO. | PRICE | FIG. NO. | PRICE |
| 4 | 6019 | | | |
| 6 | 6021 | | 44417 | |
| 8 | 6022 | | 44418 | |
| 10 | 6027 | | 44419 | |
| 12 | 6028 | | 44420 | |
| 14 | 6030 | | | |

ANTI-SYPHON PATTERN PROVIDES:

***FREEZE PROTECTION** - Water from hydrant will drain in a steady gentle stream for approximately 15-20 seconds after hydrant is turned off.

***HEALTH PROTECTION** - In the event of back syphonage due to a drop in inlet pressure, the vacuum breaker will intake air through the post to break the syphoning action. Any water trying to make its way back to the potable water supply due to back syphonage or back pressure will be blocked at the point of the back flow preventer/vacuum breaker and drain harmlessly to the ground through the air ports.

LOCKSHIELD SILLCOCKS



KEEP VANDALS AWAY FROM YOUR FAUCETS!

| SIZE | FIG. NO. | PRICE |
|------|----------|-------|
| 1/2 | 18067 | |
| 3/4 | 50828 | |

SILLCOCK KEY

| FIG. NO. | PRICE |
|----------|-------|
| 17491 | |

OUTSIDE FAUCETS

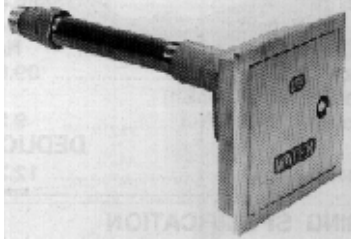

WALL HYDRANT *encased, non-freeze*

A flush, fully enclosed, fully protected installation in any type wall construction. Hinged box cover can be locked to prevent vandalism. The same key that unlocks operates hydrant. Amply wide flange of box extends over wall opening and provides neat, flush installation for modern

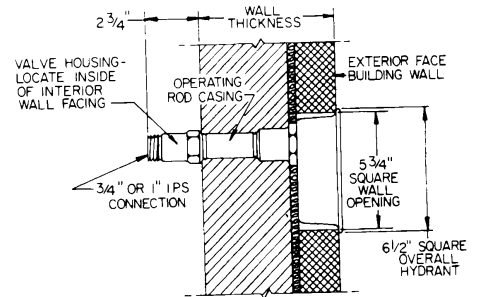

building facades.

| FIG NO | PRICE |
|---------|-------|
| DCZ1300 | |

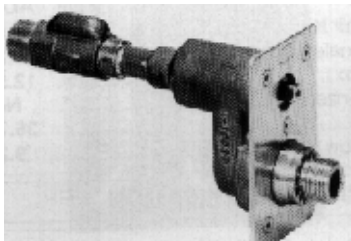

WALL HYDRANT *exposed, non-freeze, automatic draining, anti-siphon*

Where the added security of a box hydrant is not required. Optional wall clamp shown to anchor hydrant in wall. Stainless steel face provides for flush installation and years of noncorroded appearance.

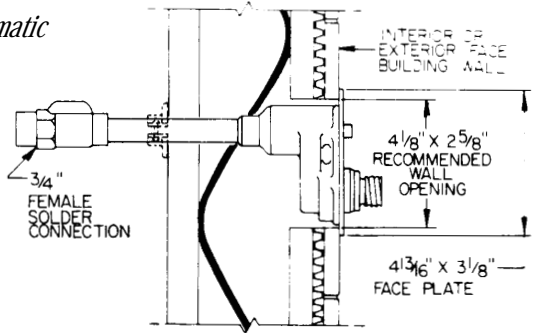

| FIG NO | PRICE |
|---------|-------|
| DCZ1321 | |

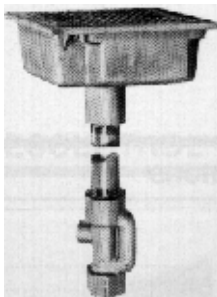

POST HYDRANT EXPOSED, NON-FREEZE

A unique housing designed for aesthetic appeal. Siphon resistant drain port prevents sub-surface water contamination from entering hydrant. Upward movement of the washer guide when the hydrant is turned on, positions O Rings to seal off drain port. When hydrant is turned off, the washer guide moves down, clearing drain port to permit complete drainage

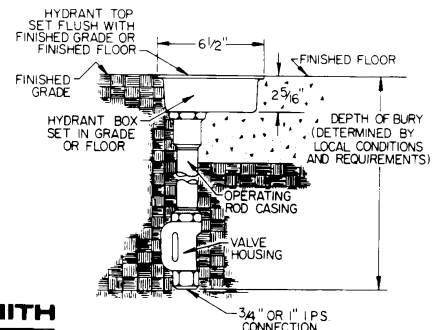

| FIG NO | PRICE |
|---------|-------|
| DCZ1360 | |



BARREL FAUCETS



PLASTIC Conventional polyethylene construction. Two sizes offered, 3/4" NPT and 2"NPT. for use with steel and polyethylene drums. Instant "on" "off" control provides smooth, fast flow with no dribble.

2" size will empty 55 gal. drum of average materials in about 3 minutes.

| SIZE | FIG NO | PRICE |
|------|--------|-------|
| 3/4 | 18962 | |
| 2 | 30045 | |

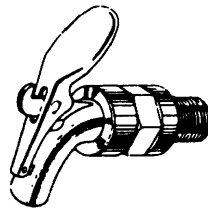

DIE CAST Automatically self-closing. Push lever control; functions perfectly in all climactic conditions. Nylon valve and tempered coil spring. Can be padlocked in open or closed position.

| FIG NO | PRICE |
|--------|-------|
| 5308 | |

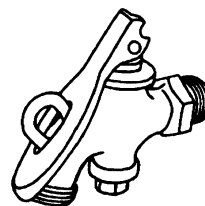

BRASS Modern design; large flow capacity. Spring held plug assures easy turning and perfect adjustment. Cadmium plated steel handle

| FIG NO | PRICE |
|--------|-------|
| 5307 | |

HYDRANT KEYS

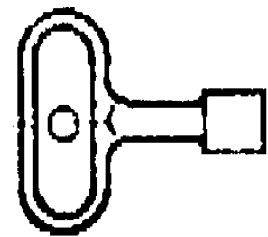

| SIZE | FIG NO | PRICE |
|-------|--------|-------|
| SMITH | 29207 | |
| ZURN | 17997 | |

For additional information call: 610-275-4453 or Fax: 610-279-6299

Please call for current prices.

DUFF CO.

VALVES

BALL VALVE WITH WASTE

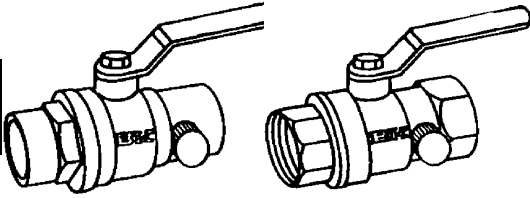

| SIZE | SWEAT | | THREADED | |
|------|----------|-------|----------|-------|
| | FIG. NO. | PRICE | FIG. NO. | PRICE |
| 1/2 | 17609 | | 17612 | |
| 3/4 | 17610 | | 17613 | |
| 1 | 17611 | | 17614 | |

COMPRESSION BALL VALVE

Heavy duty brass construction. Rated for 600 PSI of water, oil or air. Teflon seals. Compression end for solderless connection to copper tubing.

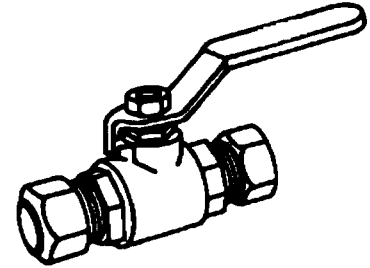

| SIZE | FIG NO | PRICE |
|------|--------|-------|
| 1/2 | 42935 | |
| 3/4 | 42936 | |
| 1 | 42937 | |



PET COCKS

Tested at 80 LBS air pressure - Standard - Spring bottom, 5/32" port

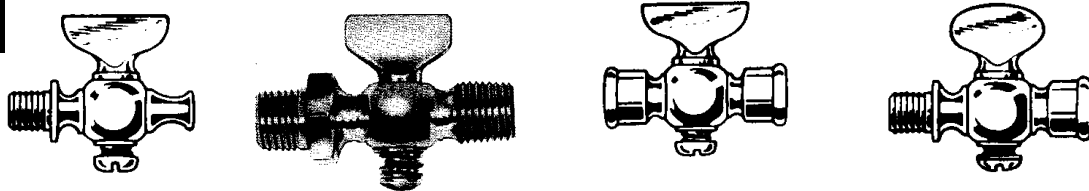

| SIZE | AIR COCK | | DOUBLE MALE | | DOUBLE FEMALE | | MALE X FEMALE | |
|------|----------|-------|-------------|-------|---------------|-------|---------------|-------|
| | FIG NO | PRICE | FIG NO | PRICE | FIG NO | PRICE | FIG NO | PRICE |
| 1/8 | 8450 | | 8460 | | 8469 | | 8479 | |
| 1/4 | 8453 | | 8462 | | 8471 | | 8481 | |
| 3/8 | 8456 | | 8464 | | 8473 | | 8482 | |
| 1/2 | 8458 | | 8466 | | 8475 | | 8483 | |

COMPRESSION VALVE

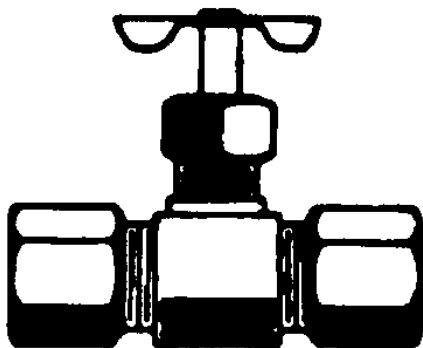

| TUBE OD SIZE | FIG NO | PRICE |
|--------------|--------|-------|
| 1/4 | 4996 | |
| 3/8 | 4997 | |

FLARE VALVE

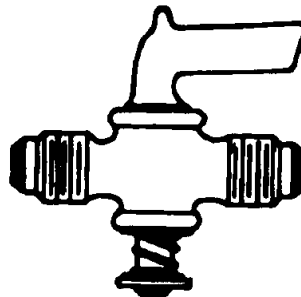

| TUBE OD SIZE | FIG NO | PRICE |
|--------------|--------|-------|
| 1/4 | 5003 | |
| 3/8 | 5007 | |
| 1/2 | 5009 | |

DRAIN COCK

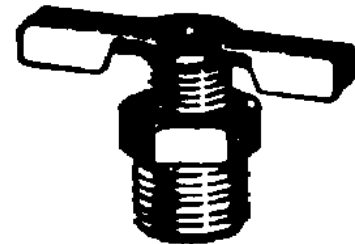

| PIPE SIZE | FIG NO | PRICE |
|-----------|--------|-------|
| 1/8 | 5042 | |
| 1/4 | 5045 | |
| 3/8 | 5047 | |
| 1/2 | 5052 | |

How to Select Valves for Your Service

The purpose of a valve is to stop or control the flow of material through a piping system. Valves are manufactured in various configurations. Practically any type of end connection is available.

GATE VALVE

As the name implies this particular valve has a gate that moves perpendicular to flow of the service. In the up position it is open. In the down position it is closed. The flow is straight through, so it does not lend itself for use as a metering valve. The gate valve is used mainly as an on-and-off valve.

Gate valves are furnished in screwed, socket weld, screwed by socket weld, raised face flange, flat face flange, RTJ face and butt weld end connections.

Gate valve extras include:

1. Split, Flex or Solid Wedge
2. Stellite Seat & Disc
3. Rising or Non-Rising Stem

GLOBE VALVE

In the globe valve, the flow pattern is offset and not a straight through flow. This design affords a better closure than a gate valve and can be used for metering. All end connections previously mentioned in this manual are available.

Valves are supplied in a wide variety of materials. Smaller sizes, 2" and under, are manufactured in both forged and cast material. Above 2" are generally in cast material. For material specifications see page 18.

TRIM

Trim refers to stem, seat and disc in Gate Valves and Disc Plug in Globe Valves.

A variety of trims can be used on the seat, stem, or disc. 11% to 13% chrome (F6,410SS) is accepted as standard on most types of valves.

NEEDLE VALVE

This valve is generally used on instrumentation because of its excellent control of flow. The stem is a tapered needle and the flow pattern is offset.

CHECK VALVE

This valve is used to stop back flow to the upstream side of the valve. The design is quite simple. A hinged door or ball is placed inside the valve. With the pressure coming upstream the door or ball is held open; when the pressure increases on the downstream side, it forces the door or ball to close, stopping any back flow.

The wide variety of check valves available makes this valve quite versatile:

HORIZONTAL SWING

Designed to operate in the horizontal position.

PISTON

This valve works up and down providing a strong, firm seal under high pressure conditions.

BALL

Uses a ball rather than a clapper.

BALL VALVE

(Reduced Pattern Design)

A ball is set between two seats, with a hole through the center. By turning the handle 90° you go from full on to full off. This design does not lend itself to metering. All end connections available.

BUTTERFLY VALVE

Similar to a ball valve except a door or rotating "gate" is used. A turn of 90° on the handle goes from full on to full off.

PLUG VALVE

A solid plug is set in the body with a hole through the center. The straight through flow pattern does not permit metering. Like Ball and Butterfly valves, a 90° turn on handle goes from full on to full off. All end connections available.

FLOW CHARACTERISTICS and RESISTANCE

The amount of fluid permitted to pass through a valve varies with its basic pattern. Generally, the greater the degree of pressure control, the greater the restriction of flow, pressure drop and energy loss. Many formulas and equations have been developed to determine precisely pressure drops and energy losses for specific sizes of valves, types of valves, fluids, and flow conditions.

To assist in making average calculations, the diagrams on the right indicate the **relative capacity and direction of flow permitted by several basic valve patterns**, and the table at the bottom of the page gives the approximate **flow resistance of full open valves compared to the equivalent feet of schedule 40 pipe**.

As indicated, gate valves allow maximum flow, with butterfly, ball, Y, swing check, angle, globe, and lift check patterns following in increasing order of flow resistance.

VALVE TYPE

| VALVE SIZE, IN. | GATE | B L V | B F V | Y | SWING CHECK | ANGLE | GLOBE |
|-----------------|------|-------|-------|------|-------------|-------|-------|
| 1/2 | 0.4 | 2 | — | 3.6 | 4 | 8 | 16 |
| 3/4 | 0.5 | 1.5 | — | 4.5 | 5 | 12 | 22 |
| 1 | 0.6 | 1.9 | — | 6.3 | 7 | 15 | 27 |
| 1 1/4 | 0.8 | 2.4 | — | 8.0 | 9 | 18 | 37 |
| 1 1/2 | 0.9 | 2.8 | — | 10.0 | 11 | 21 | 44 |
| 2 | 1.2 | 3 | 2.2 | 12.5 | 14 | 28 | 55 |
| 2 1/2 | 1.4 | — | 2.6 | 13.5 | 15 | 32 | 65 |
| 3 | 1.6 | 4.7 | 2.9 | 18.0 | 19 | 41 | 80 |
| 3 1/2 | 2.0 | — | — | 20.0 | 22 | 50 | 100 |
| 4 | 2.2 | 4.4 | 3.9 | 22.5 | 25 | 55 | 120 |
| 5 | 2.9 | — | 5.4 | 28.0 | 32 | 70 | 140 |
| 6 | 3.5 | 9.7 | 6.3 | 36 | 40 | 80 | 160 |
| 8 | 4.5 | — | 6.8 | 45 | 50 | 110 | 220 |
| 10 | 5.5 | — | 7.5 | 58 | 65 | 140 | 280 |
| 12 | 6.5 | — | 9.0 | 68 | 75 | 160 | 340 |
| 14 | 8.0 | — | — | 81 | 90 | 190 | 380 |
| 16 | 9.0 | — | — | 95 | 105 | 220 | 430 |
| 18 | 10.0 | — | — | 108 | 120 | 250 | 500 |
| 20 | 12.0 | — | — | 117 | 130 | 270 | 550 |
| 24 | 14.0 | — | — | 135 | 150 | 380 | 650 |

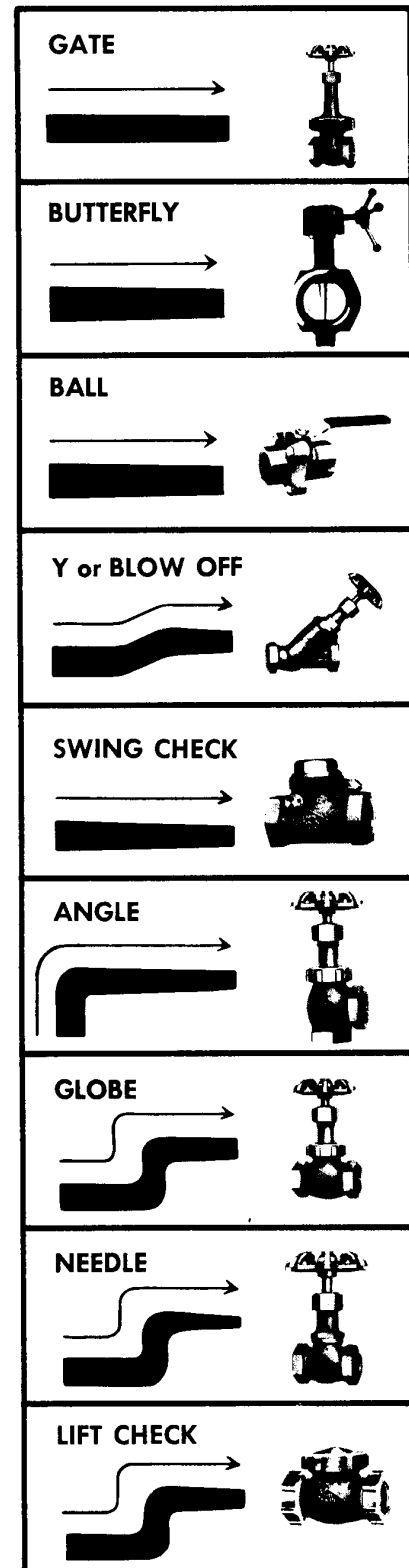

CALL OR FAX DUFF'S VALVE EXPERTS
PHONE 610-275-4453
FAX 610-279-6299

VALVE INSTALLATION TIPS

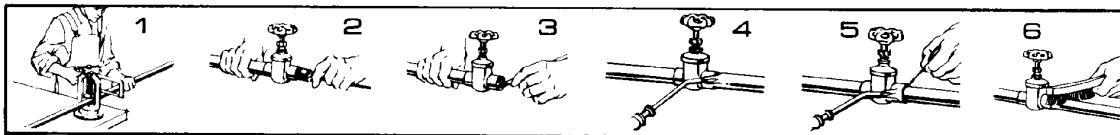
**SOLDERING AND SILVER BRAZING**

Analyze the application to determine which valve is best suited for installation, keeping in mind the service for which the valve is recommended. Before installing the correct valve, review the installation instructions to prevent damage to the valve and assure its maximum efficiency.

1. Cut tube and square. Ream, burr and size.
2. Use sand cloth or steel wire brush to clean both tube and cut to bright metal. Steel wool is not recommended.
3. Apply flux to outside of tube and inside of solder cup. Surfaces to be joined must be completely covered. Use flux sparingly.
4. Be sure that valve is fully open. Apply heat to tube first. Transfer as much heat as possible through tube into valve. Avoid prolonged heating of valve itself.

4a. Silver Brazing Method:

Assemble parts to be brazed. If fluxed parts are allowed to stand, the water in the flux will evaporate; and dried flux is liable to flake off, exposing metal surfaces to oxidation. Assemble joint by inserting tube into socket hard against the stop. The assembly should be firmly supported so that it will remain in alignment during the brazing operation. Removal of bonnet is recommended when installing U-Valves or globe valves with soft seats.

NOTE: On one inch and larger valves, it is difficult to bring the whole joint up to temperature at one time. It will frequently be found desirable to use a double tip torch to maintain the proper temperature over the larger area. A mild pre-heating of the whole socket area is recommended. Larger valves should be disassembled or the bonnets wrapped with wet rags or padding. Apply heat to parts to be joined. The preferred method is by oxy-acetylene flame. Heat tube first beginning one inch from edge of valve. Sweep flame around tube in short strokes up and down at right angles to run of tube. To avoid burning through tube, the flame should be in continuous motion and not allowed to remain on any one point.

Apply flame to valve at base of socket. Heat uniformly, sweeping flame from valve to tube until flux on valve becomes quiet. Avoid excessive heating of valve.

When flux appears liquid and transparent on both tube and valve, start sweeping flame back and forth along axis of joint to maintain heat on parts to be joined, especially toward base of valve socket.

5. Use just enough solder; with wire solder, use 3/4" for a 3/4" valve, etc. If too much solder is used, it may flow past tube stop and clog seating area. When joint is filled, a continuous run of solder or brazing alloy will be visible.

For additional information call: 610-275-4453 or Fax: 610-279-6299
Please call for current prices.

5a. Silver Brazing Method:

Apply brazing wire or rod at point where tube enters valve socket. Keep flame away from rod or wire as it is fed into the joint. Move flame back and forth as alloy is drawn into joint. When the proper temperature is reached, alloy will flow readily into space between tube outer wall and valve socket. When joint is filled, a continuous rim of brazing alloy will be visible.

6. Remove excess solder with small brush while plastic, leaving a fillet around end of valve as it cools.

SILVER BRAZING

The strength of a brazed joint does not vary appreciably with the different brazing materials, but depends to a large extent upon the maintenance of proper clearance between the outside of the tube and the valve socket. The interior dimensions of silver brazing valve sockets are machined to the closest tolerances and finished smooth to promote full capillary attraction.

NOTE: Care should be observed in cleaning and in removing residues of the cleaning medium. Attempting to braze a contaminated or improperly cleaned surface will result in an unsatisfactory joint. Silver brazing alloys will not flow over or bond to oxides. Oily or greasy surfaces repel fluxes, leaving bare spots which oxidize and result in voids and inclusions.

THREADING

Grit, dirt or any foreign matter accumulated in the pipe can hinder efficient valve operation and seriously damage vital valve parts. Thoroughly clean pipe internally with air or steam. When threading pipe, gauge pipe threads for size and length to avoid jamming pipe against seat and disc. Thoroughly clean threaded end to remove any harmful steel or iron deposits. For a good joint, use teflon tape or pipe dope. If pipe dope is used, apply sparingly on pipe threads, never on valve threads. Do not allow any pipe dope into valve body in order to avoid damage to disc and seat. Before installation, check line of flow through valve so that valve will function properly. Close valve completely before installation. Apply wrench to hex next to pipe and guard against possible distortion. After installation of valve, support line; a sagging pipe line can distort the valve and cause failure.

FLANGED

There are several steps to follow to make sure that a flanged joint will be properly assembled. First clean the joint carefully. Then loosely assemble the joint by putting in the bottom two or three bolts. Then carefully insert the gasket into place. The bottom bolts will help locate the gasket and hold it in position. Then insert the rest of the bolts into place and tighten all of the bolts evenly - not in rotation, but by the cross over method to load the bolts evenly and eliminate concentrated stresses. The bolts should be checked for tightness after an appropriate interval of use and retightened if necessary.

BRONZE GATE, GLOBE AND CHECK VALVES CLASS 125 VALVES

125 PSI SATURATED STEAM, 200 PSI NON-SHOCK COLD WATER, OIL OR GAS



| SIZE | GATE VALVE | | GLOBE VALVE | | *ANGLE GLOBE | | **SWING CHECK | |
|-------|------------|--------|-------------|--------|--------------|-------|---------------|--------|
| | SWEAT | THREAD | SWEAT | THREAD | THREAD | | SWEAT | THREAD |
| | FIG NO | PRICE | FIG NO | PRICE | FIG NO | PRICE | FIG NO | PRICE |
| 1/4 | - | 3551 | 37556 | 3620 | 38645 | - | 3657 | - |
| 3/8 | 3586 | 3553 | 37557 | 3634 | 38646 | 37559 | 3662 | 3662 |
| 1/2 | 3598 | 3554 | 17760 | 3640 | 38647 | 3696 | 3668 | 3668 |
| 3/4 | 3601 | 3562 | 17761 | 3643 | 38648 | 3704 | 3674 | 3674 |
| 1 | 3605 | 3563 | 17762 | 3648 | 38649 | 3717 | 3683 | 3683 |
| 1 1/4 | 4111 | 3566 | 17763 | 4118 | 38650 | 4124 | 4121 | 4121 |
| 1 1/2 | 4116 | 3568 | 17764 | 4119 | 38651 | 4125 | 4122 | 4122 |
| 2 | 3608 | 3573 | 17765 | 3652 | 38652 | 3721 | 3691 | 3691 |
| 2 1/2 | 4117 | 3578 | - | - | - | 38621 | - | - |
| 3 | 3618 | 3582 | - | - | - | 38622 | - | - |

*BRONZE ANGLE GLOBE VALVES ALSO AVAILABLE WITH SWEAT ENDS.

**Y-PATTERN CHECK VALVES MAY BE INSTALLED IN BOTH HORIZONTAL AND VERTICAL LINES WITH UPWARD FLOW OR IN ANY INTERMEDIATE POSITION.



LET OUR PIPE
AND VALVE
EXPERTS HELP
YOU!

610-275-4453

BRONZE GATE, GLOBE AND CHECK VALVES
CLASS 150 VALVES

150 PSI SATURATED STEAM, 300 PSI NON-SHOCK COLD WATER, OIL OR GAS



| SIZE | GATE VALVE NON-RISING STEM | | GATE VALVE RISING STEM | | GLOBE VALVE | | ANGLE GLOBE | | SWING CHECK | |
|------|-------------------------------|-------|---------------------------|-------|-------------|-------|-------------|-------|-------------|-------|
| | SWEAT | | THREAD | | SWEAT | | THREAD | | THREAD | |
| | FIG NO | PRICE | FIG NO | PRICE | FIG NO | PRICE | FIG NO | PRICE | FIG NO | PRICE |
| 1/4 | - | 3729 | 3777 | | 4591 | 4442 | 18341 | | 4636 | |
| 3/8 | 3968 | 3731 | 3785 | | 4597 | 4445 | 18342 | | 4640 | |
| 1/2 | 3973 | 3736 | 3789 | | 4599 | 4447 | 18288 | | 4646 | |
| 3/4 | 4052 | 3740 | 3795 | | 4604 | 4451 | 18343 | | 4663 | |
| 1 | 4075 | 3743 | 3801 | | 4606 | 4455 | 18344 | | 4668 | |
| 1 | 4139 | 3749 | 3805 | | 4611 | 4461 | 18345 | | 4681 | |
| 1/4 | 4136 | 3754 | 3811 | | 4614 | 4467 | 18346 | | 4685 | |
| 1 | 4076 | 3760 | 3816 | | 4618 | 4478 | 18347 | | 4688 | |
| 1/2 | 4137 | 3768 | 3819 | | 4622 | 4486 | - | | 4691 | |
| 2 | 4096 | 3773 | 3828 | | 4629 | 4493 | - | | 4694 | |

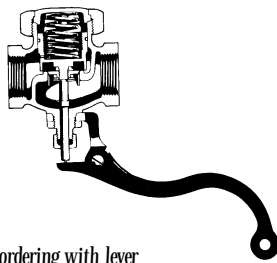

Specify if ordering with lever



Can be ordered Spring Loaded



| LEVER OPERATED GLOBE 1/4" TO 2" | LIFT CHECK (150 PSI WOG) | | | | AIR GUN (150 PSI ONLY) | |
|---|-----------------------------|-------|----------|-------|---------------------------|-------|
| | HORIZONTAL | | VERTICAL | | FIG NO | PRICE |
| SIZE | FIG NO | PRICE | FIG NO | PRICE | | |
| PROVIDE SIZE, SERVICE (STEAM OR WATER), AND WHETHER A LEVER IS NEEDED | 1/4 | 4722 | | 4749 | 39342 | |
| | 3/8 | 4726 | | 4753 | 39343 | |
| | 1/2 | 4728 | | 4756 | - | |
| | 3/4 | 4729 | | 4758 | - | |
| | 1 | 4736 | | 4763 | - | |
| | 1 1/4 | 4738 | | 4766 | - | |
| | 1 1/2 | 4744 | | 4770 | - | |
| | 2 | 4747 | | 4773 | - | |

BRONZE GATE, GLOBE AND CHECK VALVES CLASS 300 VALVES

300 PSI SATURATED STEAM, 600 PSI NON-SHOCK COLD WATER, OIL OR GAS



| GATE | | GLOBE | | SWING CHECK | | NEEDLE GLOBE 200 PSI | |
|------|--|-------|--|-------------|--|-------------------------|--|
|------|--|-------|--|-------------|--|-------------------------|--|

| SIZE | FIG NO | PRICE | FIG NO | PRICE | FIG NO | PRICE | FIG NO | PRICE |
|-------|--------|-------|--------|-------|--------|-------|--------|-------|
| 1/8 | - | | - | | - | | 4804 | |
| 1/4 | 3834 | | 4500 | | 4698 | | 4808 | |
| 3/8 | 3844 | | 4509 | | 4703 | | 4813 | |
| 1/2 | 3848 | | 4547 | | 4709 | | 4816 | |
| 3/4 | 3851 | | 4556 | | 4714 | | 4817 | |
| 1 | 3852 | | 4562 | | 4715 | | - | |
| 1 1/4 | 4127 | | 4565 | | 4716 | | - | |
| 1 1/2 | 4128 | | 4579 | | 4717 | | - | |
| 2 | 3961 | | 4587 | | 4720 | | - | |
| 2 1/2 | - | | - | | 4719 | | - | |
| 3 | - | | - | | 4721 | | - | |



PIPE MARKERS



AVAILABLE IN ALL WORDING

VALVE TAGS

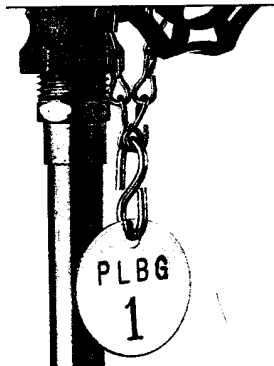

AVAILABLE NUMBERED
OR LETTERED!

VALVE LOCKOUT

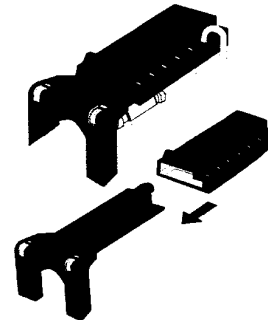

BALL VALVES AVAILABLE 3/8" TO 2 1/2"
GATE VALVES 1" TO 10"

**ALL DUFF IDENTIFICATION
PRODUCTS READILY AVAILABLE!**

BALL VALVES

BRONZE - TWO PIECE - 600 PSI

**FULL PORT UP TO 1" * CONVENTIONAL PORT 1 1/4" TO 3"
FULL PORT AVAILABLE IN ALL SIZES**

15 SWP, 600 WOG, CHROME PLATED BALL, REINFORCED TFE SEATS

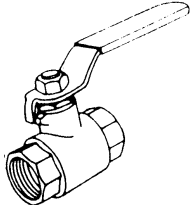

| | | 1/4" | 3/8" | 1/2" | 3/4" | 1 | 1 1/4" | 1 1/2" | 2 | 2 1/2" | 3 | 4 |
|---------------|-----------------|-------|------|------|------|------|--------|--------|------|--------|------|------|
| SWEAT | FIG. NO. | 38108 | 3726 | 3737 | 3741 | 3772 | 3823 | 3765 | 3823 | 3837 | 4058 | - |
| | PRICE | | | | | | | | | | | |
| THREAD | FIG. NO. | 3673 | 3677 | 3679 | 3684 | 3686 | 3703 | 3708 | 3711 | 3713 | 3716 | 3723 |
| | PRICE | | | | | | | | | | | |

BRONZE - TWO PIECE WITH SS BALL & STEM - 600 PSI

**FULL PORT UP TO 1" * CONVENTIONAL PORT 1 1/4" TO 3"
FULL PORT AVAILABLE IN ALL SIZES**

150 SWP, 600 WOG, 316SS BALL AND STEM, REINFORCED TFE SEATS

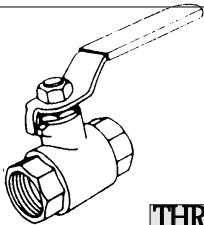

| | | 1/4" | 3/8" | 1/2" | 3/4" | 1 | 1 1/4" | 1 1/2" | 2 | 2 1/2" | 3" |
|---------------|-----------------|-------|-------|-------|-------|-------|--------|--------|-------|--------|-------|
| THREAD | FIG. NO. | 50394 | 50395 | 50396 | 50397 | 50398 | 50399 | 50400 | 50401 | 50402 | 50403 |
| | PRICE | | | | | | | | | | |
| SWEAT | FIG. NO. | 50383 | 50384 | 50385 | 50386 | 50387 | 50388 | 50389 | 50390 | 50391 | 50392 |
| | PRICE | | | | | | | | | | |

STAINLESS AND CARBON STEEL - TWO PIECE - 2000 PSI

1/2" - 2" = STANDARD PORT * THREADED ENDS

1/2" - 1" ARE RATED AT 2000 PSI * 1 1/4" - 2" ARE RATED AT 1500 PSI

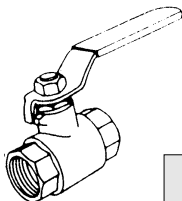

| | | 1/4" | 3/8" | 1/2" | 3/4" | 1 | 1 1/4" | 1 1/2" | 2 | 3 |
|------------------------|-----------------|------|------|------|------|------|--------|--------|------|-------|
| Stainless Steel | FIG. NO. | 4114 | 4115 | 4120 | 4123 | 4126 | 4129 | 4131 | 4132 | 38612 |
| | PRICE | | | | | | | | | |
| Carbon Steel | FIG. NO. | 4072 | 4078 | 4088 | 4083 | 4091 | 4093 | 4112 | 4113 | - |
| | PRICE | | | | | | | | | |

BALL VALVES

BRONZE - TWO PIECE - 600 PSI - LOCKING HANDLE

CONVENTIONAL PORT

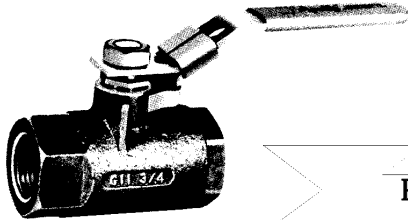

PROTECT YOUR EMPLOYEES AND
YOURSELF!



| | | 1/4" | 3/8" | 1/2" | 3/4" | 1" | 1" | 1 1/4" | 1" | 1/2" | 2" |
|----------|-------------------|-------|-------|-------|-------|-------|-------|--------|-------|-------|-------|
| SWEAT | FIG. NO. PRICE | 50570 | 50571 | 50572 | 50573 | 50574 | 50575 | 50576 | 50577 | 50578 | 50579 |
| THREADED | FIG. NO. PRICE | 50560 | 50561 | 50562 | 50563 | 50564 | 50565 | 50566 | 50567 | 50568 | 50569 |

BRONZE * THREE PIECE

FULL PORT, STAINLESS AND CARBON STEEL ARE ALWAYS AVAILABLE

| | | 1/4" | 3/8" | 1/2" | 3/4" | 1" | 1 1/4" | 1 1/2" | 2" | 2 1/2" |
|--------|-----------------|------|------|------|------|------|--------|--------|------|--------|
| SWEAT | FIG. # PRICE | 4147 | 4148 | 4149 | 4150 | 4152 | 4154 | 4156 | 4159 | 4161 |
| THREAD | FIG. # PRICE | 4133 | 4135 | 4138 | 4140 | 4141 | 4142 | 4143 | 4144 | 4145 |



FLANGED * CAST IRON

SAME FACE TO FACE DIMENSION AS A GATE VALVE



**ALSO
AVAILABLE WITH
GEAR
OPERATOR!**

| | | 2" | 2 1/2" | 3" | 4" | 6" | 8" |
|----------|--|-------|--------|-------|-------|-------|-------|
| FIG. NO. | | 18136 | 18137 | 18138 | 18139 | 18140 | 53214 |
| PRICE | | | | | | | |

BALL VALVES

BRONZE THREE WAY BALL VALVE

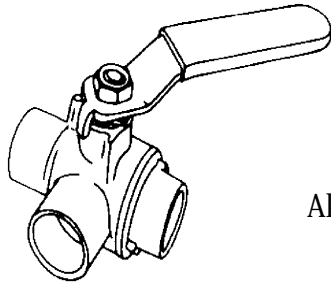

Also available stainless or carbon steel

| SIZE | SWEAT | | THREADED | |
|-------|--------|-------|----------|-------|
| | FIG NO | PRICE | FIG NO | PRICE |
| 1/4 | 50470 | | 4175 | |
| 3/8 | 50471 | | 4176 | |
| 1/2 | 50472 | | 4177 | |
| 3/4 | 50473 | | 4178 | |
| 1 | 50474 | | 4179 | |
| 1 1/4 | 50475 | | 4180 | |
| 1 1/2 | 50476 | | 4182 | |
| 2 | 50477 | | 4186 | |
| 2 1/2 | 50478 | | 4187 | |
| 3 | 50479 | | 4188 | |

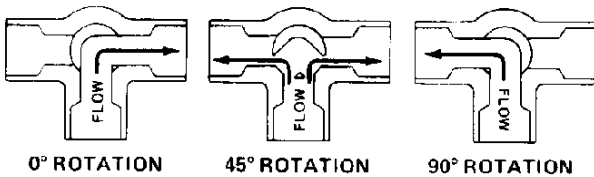

This full port three way ball valve is the ideal choice fluid systems requiring minimum pressure loss and "diverter" operation. Use for water, oil or gas up to 400 psi.

REPLACES 2 BALL VALVES AND A TEE

CLASS 150 AND 300 FLANGED BALL VALVES

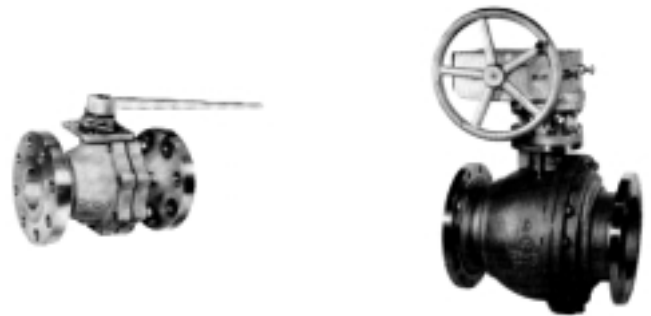

**STAINLESS STEEL - BRONZE - CARBON STEEL
SIZES THROUGH 12"**

ACTUATED BALL VALVES



PNEUMATIC

ELECTRIC

Actuators available for all size valves

BALL VALVES FOR COMPRESSED AIR

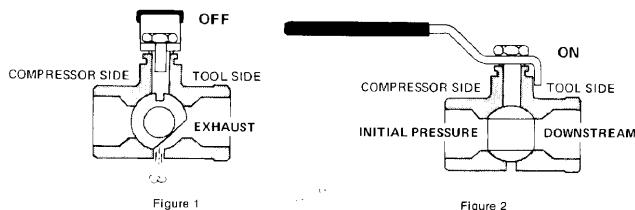

The safety exhaust valve body and ball are drilled to provide vent for relieving air pressure downstream. In the closed, or off position (figure 1), the valves provide continuous air relief on the downstream side of the valve to 175 psi. Ideal for use when applied pressure to downstream equipment must be relieved for safety reasons. In the open, or on position (Figure 2), the valves provide bubble tight and leakproof service to the downstream side of the valve.

ELECTRIC MOTOR VALVES



SIZES 3/4" THROUGH 2"

BALL VALVE OPTIONS
(Every option not available for every valve)



Ground Washer
GROUND STEM
(Ground Washer)
Stainless steel washer used for grounding the lever and stem to the body of the valve to prevent the build-up of static electric charge.



Round Handle
ROUND HANDLE
Safety handle resistant to accidental operation

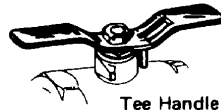

Tee Handle
TEE HANDLE
Compact handle ideally suitable where space is a problem for safety reasons.

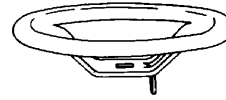

Oval Handle - Low Profile
OVAL HANDLE
LOW PROFILE
Used in lieu of lever handles for safety. Also visually indicates open or closed positions. Extension is 1".

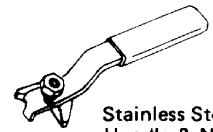

Stainless Steel Handle & Nut
STAINLESS STEEL HANDLE & NUT
For use on bronze and carbon steel ball valves where the atmosphere is corrosive. Standard on s8000/s8500 series stainless steel valves.



Extended Handle
EXTENDED HANDLE
For insulated pipe in heating or air conditioning systems. Extension is 3".

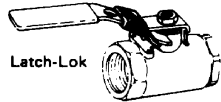

Latch-Lok
LATCH-LOK
(Handle Only)
This patented option provides the ability to latch as well as lock the ball valve in both the on or off position. Ideal for hazardous pipe lines where tamperproof protection is a must.

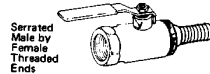

Serrated Male by Female Threaded Ends
SERRATED MALE BY FEMALE THREADED ENDS
Commonly used with plastic and rubber hose connections; for positive shut-off.



Oval Handle - High Profile
OVAL HANDLE
HIGH PROFILE
Used on insulated piping service. Extension of the handle is 2".

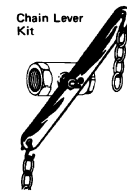

Chain Lever Kit
CHAIN LEVER KIT
For industrial showers and other remote pipe requirements. Chain not furnished.

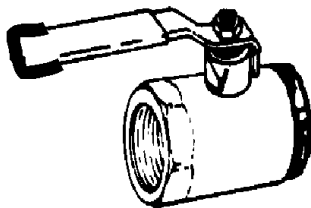

ROUGH CHROME
For matching up with any laboratory, restaurant or hospital equipment (chrome) where appearance is important.



UL PLATE
UL listed for various services.



Balancing Stop
BALANCING STOP PLATE
For any throttling or semi-open valve requirements such as in the balancing of heating and air conditioning system.

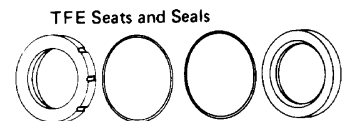

TFE SEATS AND SEALS
For food processing, pharmaceutical and similar industries where filled seats are not approved.
DURAFILL SEATS
When not standard.
450 degrees F @ 50 psi
NYLON SEATS
Used for high pressure, low temperature service.

**FOR FAST SERVICE...
FAX YOUR ORDER!
610-279-6299**

GAS COCKS

FULL PORT GAS RATED
BALL VALVE

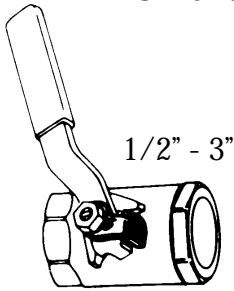

AGA GAS VALVE

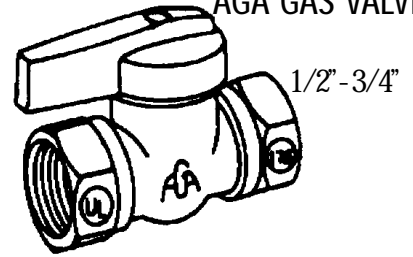

| SIZE | FIG. NO. | PRICE | FIG. NO. | PRICE |
|-------|----------|-------|----------|-------|
| 1/2 | 41975 | | 50802 | |
| 3/4 | 41976 | | 50803 | |
| 1 | 47873 | | - | |
| 1 1/4 | 6349 | | - | |
| 1 1/2 | 6352 | | - | |
| 2 | 49737 | | - | |
| 2 1/2 | 50788 | | - | |
| 3 | 50789 | | - | |

DUFF COMPANY
201 EAST LAFAYETTE STREET
NORRISTOWN, PA 19401
(610) 275-4453
FAX: (610) 279-6299



**BUYING QUALITY
 PRODUCTS
 IS LIKE BUYING
 OATS . . .**

If you want nice, clean, fresh oats,
 you must pay a fair price. However,
 if you can be satisfied with oats that
 have already been through the horse

Well . . . That Comes A Little Cheaper

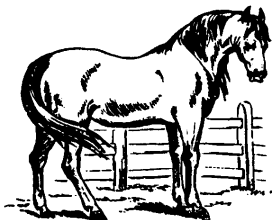

SPRING LOADED IN-LINE CHECK VALVE

Rated 250- PSIG WOG 125 SWP (with Teflon disc) for horizontal or vertical installation.

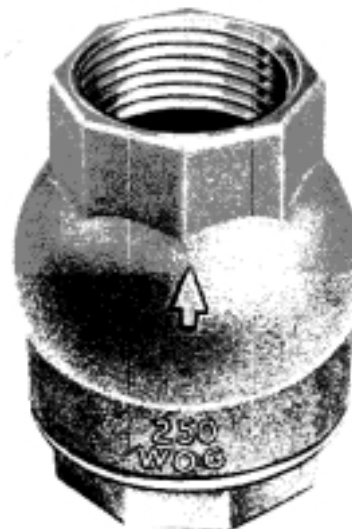

| SIZE | THREADED | | SWEAT | |
|-------|----------|-------|----------|-------|
| | FIG. NO. | PRICE | FIG. NO. | PRICE |
| 3/8 | 6034 | | 44415 | |
| 1/2 | 6035 | | 6071 | |
| 3/4 | 6046 | | 6075 | |
| 1 | 6038 | | 19012 | |
| 1 1/4 | 6040 | | 44412 | |
| 1 1/2 | 6042 | | 44413 | |
| 2 | 6069 | | 44414 | |

FLOATS, FLOAT AND FILL VALVES

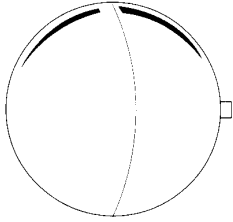

SINGLE SPUD ROUND FLOAT

| FLOAT DIAMETER | TAPPING | COPPER FOR STANDARD SERVICE | | STAINLESS STEEL TYPE 304 STANDARD FOR CORROSIVE AND NON-CORROSIVE FLUIDS TO 800 DEGREES F. AND 150 PSI | |
|----------------|------------|-----------------------------|-------|--|-------|
| | | FIG. NO. | PRICE | FIG. NO. | PRICE |
| 3 | 1/4-20 SAE | 4937 | | 4974 | |
| 4 | 1/4-20 SAE | 4938 | | 4978 | |
| 5 | 1/4-20 SAE | 4942 | | 4981 | |
| 6 | 1/4-20 SAE | 4944 | | 4991 | |
| 7 | 3/8 F.I.P. | 4945 | | 5004 | |
| 8 | 3/8 F.I.P. | 4946 | | 5011 | |
| 10 | 3/8 F.I.P. | 4962 | | 5014 | |
| 12 | 3/8 F.I.P. | 4969 | | 5015 | |

BRASS AUTOMATIC FILL VALVE

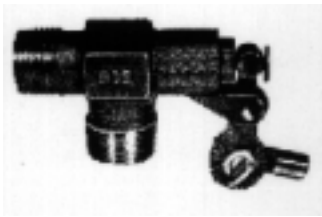

Sizes 3/8" to 1"
Threaded Inlet and Outlet

| SIZE | FIG NO | PRICE |
|-------|--------|-------|
| 3/8 | 4915 | |
| 1/2 | 4919 | |
| 3/4 | 4921 | |
| 1 | 4926 | |
| 1 1/4 | 4928 | |
| 1 1/2 | 4931 | |
| 2 | 47589 | |

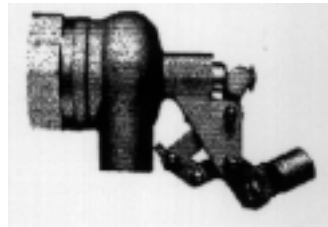

Sizes 1 1/4" to 2"
Threaded Inlet/Free Flow Outlet

FLOAT ROD

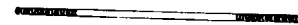

1/4 X 20 SAE

| SIZE | FIG NO | PRICE |
|------|--------|-------|
| 8" | 15056 | |
| 9" | 15057 | |
| 10" | 15058 | |
| 12" | 15059 | |

TYPICAL FILL VALVE INSTALLATION

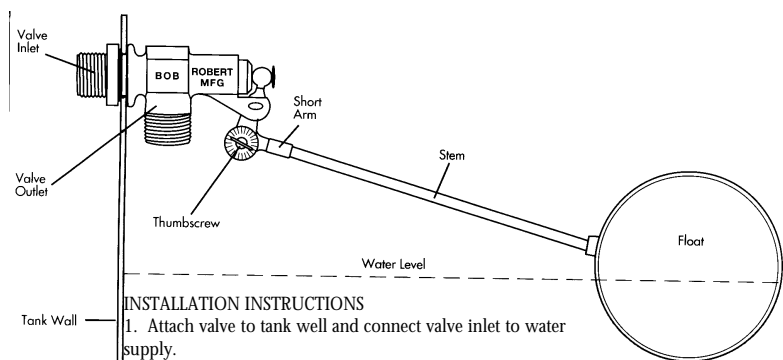

INSTALLATION INSTRUCTIONS

1. Attach valve to tank well and connect valve inlet to water supply.
2. Valve outlet must be 90 degrees to water level for bind-free operation.
3. Screw stem and float to short arm.
4. Rotate arm and stem for desired water level, tighten short arm thumbscrew.

Stainless steel floats and valves ready for immediate shipment

BRASS INDUSTRIAL FLOAT VALVES

Dimensions/Specifications

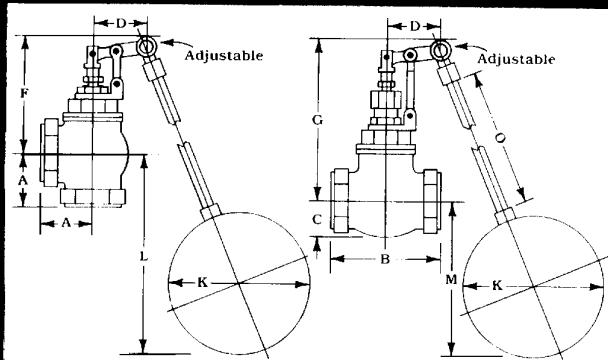

Direct Float Valve for open tank service. Angle type shown. Globe straight-through type also available.

Direct Float Valve with stuffing box for closed tank or submerged service. Globe straight-through type shown. Angle type also available.

APPLICATION

Float valves are recommended for controlling a constant level in storage tanks, reservoirs, cooling towers, filtering plants and in all types of industries such as paper mills, packing plants, chemical plants, steel mills, textile mills, laundries, breweries, etc.

OPERATION

The standard operation is where a fall in liquid level will open the valve and a rise in the level will close the valve. However, by reversing the linkage the opposite of the above operation will occur.

Approximate Gallons-Per-Minute Flow Capacity @55 P.S.I.

| Valve Size | 1/2" | 3/4" | 1" | 1 1/4" | 1 1/2" | 2" | 3" |
|------------|------|------|----|--------|--------|-----|-----|
| GPM | 30 | 50 | 75 | 100 | 125 | 175 | 400 |

Pressure Ratings/Float Sizes/Rod Sizes/Dimensions Gade Float & Lever Valves

| NPT Valve Size (IPS) | Maximum Inlet Pressure | Standard Float Size | Standard Float Rod | Dimensions in Inches | | | | | | | | | | | | | | |
|----------------------|------------------------|---------------------|--------------------|----------------------|-------|--------|-------|-------|-------|-------|--------|--------|---|--------|--------|----|--|--|
| | | | | A | B | C | D | E | F | G | H | J | K | L | M | O | | |
| 1/2" | 100# | 5" | 1/4"IPS x 16" | 1 3/8 | 2 7/8 | 1 3/16 | 2 1/4 | 1 | 4 | 5 1/2 | 6 | 12 1/4 | 5 | 11 | 11 | 16 | | |
| 3/4" | 100# | 5" | 1/4"IPS x 16" | 1 1/2 | 3 | 7/8 | 2 1/4 | 1 | 4 | 5 1/2 | 6 | 12 1/4 | 5 | 11 1/8 | 11 | 16 | | |
| 1" | 100# | 6" | 1/4"IPS x 18" | 1 3/4 | 4 | 1 3/16 | 2 1/4 | 1 | 4 1/4 | 6 | 6 3/8 | 12 1/4 | 6 | 11 1/2 | 11 1/2 | 18 | | |
| 1 1/4" | 100# | 6" | 1/4"IPS x 18" | 2 | 4 1/4 | 1 3/8 | 2 1/4 | 1 | 4 3/4 | 6 1/2 | 6 7/8 | 12 1/4 | 6 | 11 3/4 | 12 1/8 | 18 | | |
| 1 1/2" | 100# | 6" | 1/4"IPS x 18" | 2 1/8 | 4 1/2 | 1 1/2 | 2 1/4 | 1 | 5 | 6 3/4 | 7 1/8 | 12 1/4 | 6 | 11 1/2 | 11 7/8 | 18 | | |
| 2" | 75# | 8" | 3/8"IPS x 20" | 2 1/2 | 5 3/4 | 2 | 3 1/4 | 1 1/2 | 6 | 8 3/4 | 9 3/4 | 15 | 8 | 14 | 13 1/2 | 20 | | |
| 3" | 75# | 8" | 3/8"IPS x 24" | 3 3/4 | 8 | 3 | 3 3/4 | 1 1/2 | 7 | 9 1/2 | 11 1/2 | 15 | 8 | 20 | 19 | 24 | | |

KECKLEY
OUR TRADE MARK YOUR GUARANTEE

Hoffman SPECIALTY

WATSON & M'DANIEL

Gadren



MOST COMMON FLOAT VALVE!

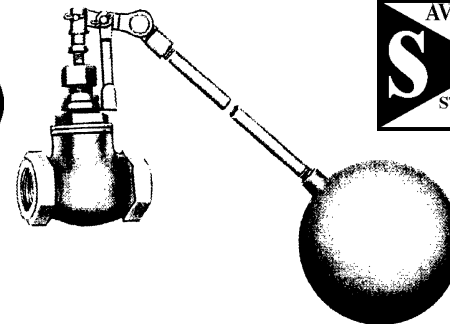

AVAILABLE IN STAINLESS STEEL

| ANGLE PATTERN | | | | |
|----------------------|------------|-------|-----------|-------|
| SIZE | COLD WATER | | HOT WATER | |
| | FIG. NO. | PRICE | FIG. NO. | PRICE |
| 1/2 | 5018 | | 5058 | |
| 3/4 | 5022 | | 5060 | |
| 1 | 5026 | | 5068 | |
| 1 | 5031 | | 5071 | |
| 1 1/4 | 5034 | | 5076 | |
| 1 | 5036 | | 50522 | |
| 1 1/2 | 5037 | | 5078 | |

| GLOBE PATTERN | | | | |
|----------------------|------------|-------|-----------|-------|
| SIZE | COLD WATER | | HOT WATER | |
| | FIG. NO. | PRICE | FIG. NO. | PRICE |
| 1/2 | 50521 | | 5080 | |
| 3/4 | 5040 | | 5082 | |
| 1 | 5044 | | 5083 | |
| 1 | 5046 | | 5088 | |
| 1 1/4 | 5048 | | 5089 | |
| 1 | 5051 | | 5238 | |
| 1 1/2 | 5053 | | 5240 | |

STAINLESS STEEL AVAILABLE FOR IMMEDIATE SHIPMENT

For additional information call: 610-275-4453 or Fax: 610-279-6299
Please call for current prices.

MORE FLOAT & LEVER VALVES

OTHER STANDARD FLOAT BALLS

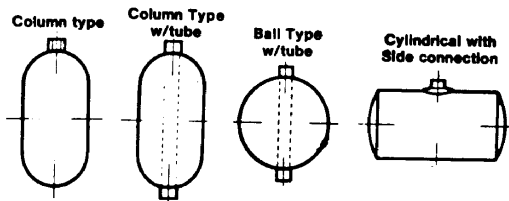

LEVER VALVE



FLOAT ADAPTERS

All sizes available.



FLANGED FLOAT VALVE

Sizes through 8"
Available in globe or angle pattern



FLOAT MECHANISM

For operating all lever valves

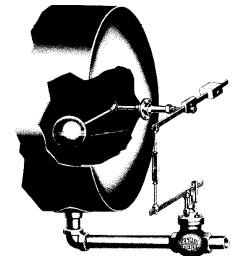
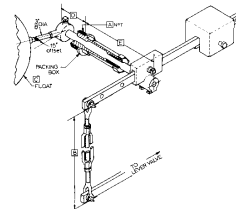

STEAM FLOAT VALVE

Sizes 1/2" to 6"



FLOAT BOX

For use in connection with closed tanks



Typical Applications

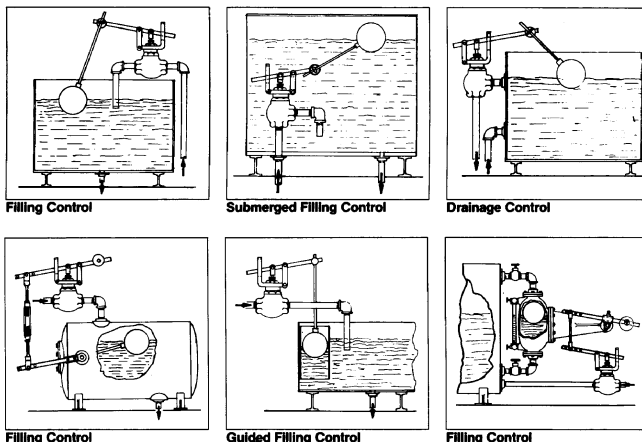

TYPICAL APPLICATIONS

- *Open or closed storage tanks
- *Vats
- *Process Tanks
- *Cooling towers
- *Basins
- *Standpipes
- *Receivers
- *Feed water heaters
- *Condensate tanks
- *Reservoirs
- *Sprinkler services
- *Swimming pools
- *All valves can be used on filling control (close on level rise) or drainage control (open on level rise) applications.

OPTIONS:

- *Floats - all materials, sizes and connections
- *Float Rods - brass, stainless steel or galvanized pipe
- *Swivel adapter - vertical operation of float rod; replaces rosette and joins the lever and float rod
- *Trim - main valve and seat can be brass or stainless steel.
- *Discs and cups - Teflon for temperatures exceeding 125 degrees F to maximum of 350 degrees F.

QUICK OPENING GATE

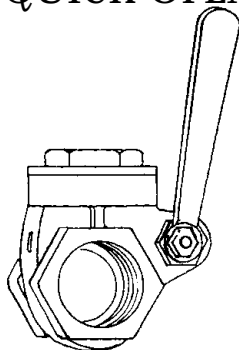

| SIZE | FIG NO | PRICE |
|-------|--------|-------|
| 3/8 | 5310 | |
| 1/2 | 5311 | |
| 3/4 | 5312 | |
| 1 | 5314 | |
| 1 1/4 | 5315 | |
| 1 1/2 | 5317 | |
| 2 | 5318 | |
| 2 1/2 | 5319 | |
| 3 | 5321 | |
| 4 | 5322 | |

MOLASSES GATE

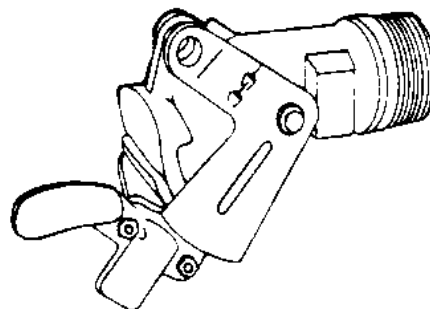

| SIZE | FIG NO | PRICE |
|-------|--------|-------|
| 3/4 | 5241 | |
| 1 | 5243 | |
| 1 1/4 | 5244 | |
| 1 1/2 | 5245 | |
| 2 | 5246 | |
| 3 | 5248 | |
| 4 | 5249 | |

FACE TO FACE DIMENSIONS
OF FLANGED IRON VALVES

| SIZE | GATE VALVES and BALL VALVES | | GLOBE and SWING CHECK VALVES | | ANGLE VALVES CENTRE TO FACE | |
|-------|-----------------------------|----------|------------------------------|----------|-----------------------------|----------|
| | 125 LBS. | 250 LBS. | 125 LBS. | 250 LBS. | 125 LBS. | 250 LBS. |
| 2 | 7 | 8 1/2 | 8 | 10 1/2 | 4 | 5 1/4 |
| 2 1/2 | 7 1/2 | 9 1/2 | 8 1/2 | 11 1/2 | 4 1/2 | 5 3/4 |
| 3 | 8 | 11 1/8 | 9 1/2 | 12 1/2 | 4 3/4 | 6 1/4 |
| 4 | 9 | 12 | 11 1/2 | 14 | 5 3/4 | 7 |
| 5 | 10 | 15 | 13 | 15 3/4 | 6 1/2 | 7 7/8 |
| 6 | 10 1/2 | 15 7/8 | 14 | 17 1/2 | 7 | 8 3/4 |
| 8 | 11 1/2 | 16 1/2 | 19 1/2 | 21 | - | 10 1/2 |
| 10 | 13 | 18 | 24 1/2 | 24 1/2 | - | - |
| 12 | 14 | 19 3/4 | 27 1/2 | 28 | - | - |
| 14 | 15 | 22 1/2 | 31 | - | - | - |
| 16 | 16 | 24 | 27 1/2* | - | - | - |
| 18 | 17 | 26 | 30 1/2* | - | - | - |
| 20 | 18 | 28 | 32 1/2* | - | - | - |
| 24 | 20 | 31 | - | - | - | - |

*These sizes are not covered by ANSI B16.10 specifications. All others in accordance with ANSI B16.10.

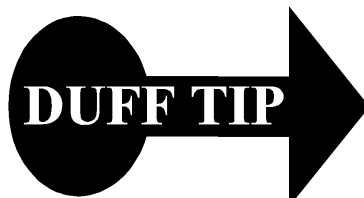

**ALL IRON BODY VALVES OF THE SAME SIZE -
NO MATTER WHO THE MANUFACTURER -
HAVE THE SAME FACE TO FACE DIMENSIONS**

CLASS 125 IRON BODY BRONZE MOUNTED GATE, GLOBE AND CHECK VALVES



| SIZE | FLANGED GATE VALVE RISING STEM | FLANGED GATE VALVE NON-RISING STEM | FLANGED GLOBE VALVE STRAIGHT | FLANGED GLOBE VALVE ANGLE FLANGED | CHECK VALVE |
|----------|--------------------------------|------------------------------------|------------------------------|-----------------------------------|-------------|
| FIG. NO. | PRICE | | | FIG. NO. | PRICE |
| 2 | 4819 | | | | 4846 |
| 2 1/2 | 4823 | | | | 4851 |
| 3 | 4824 | | | | 4855 |
| 4 | 4831 | | | | 4858 |
| 5 | 4836 | | | | 4861 |
| 6 | 4840 | | | | 4867 |
| 8 | 4842 | | | | 4869 |

AVAILABLE FOR IMMEDIATE DELIVERY!

ALL FLANGED GATES, GLOBES AND CHECKS AVAILABLE IN 250 SB 500 WOG RATINGS. CALL FOR IMMEDIATE DELIVERY!

ALL IRON GATE, GLOBE AND CHECK VALVES



| SIZE | FIG NO | PRICE |
|-------|--------|-------|
| 2 | 18348 | |
| 2 1/2 | 18349 | |
| 3 | 18351 | |
| 4 | 18352 | |



AVAILABLE FOR IMMEDIATE DELIVERY!



| SIZE | FIG NO | PRICE |
|-------|--------|-------|
| 1/4 | 4874 | |
| 3/8 | 4876 | |
| 1/2 | 4880 | |
| 3/4 | 4885 | |
| 1 | 4886 | |
| 1 1/4 | 4888 | |
| 1 1/2 | 4889 | |
| 2 | 4891 | |
| 2 1/2 | 4893 | |
| 3 | 4896 | |



AVAILABLE FOR IMMEDIATE DELIVERY!



AVAILABLE FOR IMMEDIATE DELIVERY!



AVAILABLE FOR IMMEDIATE DELIVERY!



VALVES

NON-RETURN STOP CHECK VALVES



Y-PATTERN



STRAIGHT



ANGLE

SIZES 3" TO 10"

These valves are recommended as a check valve on each boiler in a multiple unit plant.

FOOT VALVES

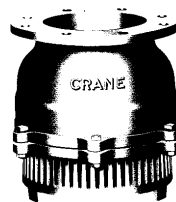
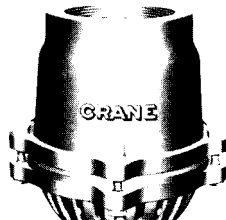
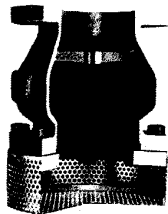

1/2" THROUGH 30"

For positive prime with silent operation. Full flow area positive shut-off at all ranges. Silent operation.

More foot valves in pump section!

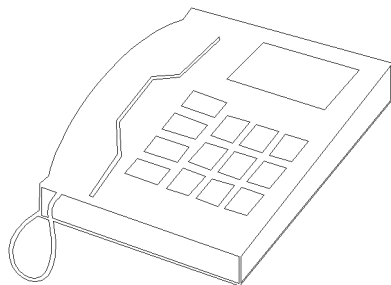

CALL DUFF FIRST!

For additional information call: 610-275-4453 or Fax: 610-279-6299
Please call for current prices.

DUFF CO.

SILENT CHECK VALVES

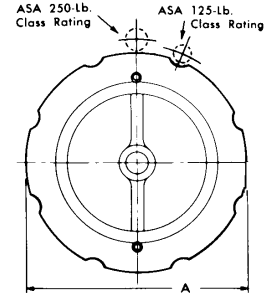

| SIZE | FIG NO | PRICE |
|-------|--------|-------|
| 2 | 44434 | |
| 2 1/2 | 44435 | |
| 3 | 44436 | |
| 4 | 44437 | |
| 5 | 44438 | |
| 6 | 44439 | |
| 8 | 44440 | |
| 10 | 44441 | |

Use only with flat face flange and full-face gasket

SILENT CHECK VALVES

125 WOG

IDEAL FOR WHEN CHECK VALVE IS LOCATED ON DISCHARGE SIZE OF PUMP. RESULTS IN A SAFE AND SILENT PIPING SYSTEM.

GLOBE STYLE

TWIN DISC STYLE

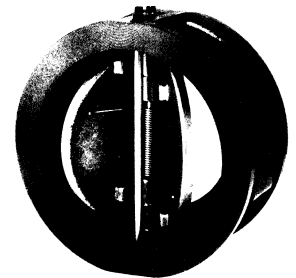

WARNING: Silent check valves may not be used as steam valve or for any air service. Install 3 to 4 pipe diameters from pump discharge or elbows to avoid flow turbulence.

BUTTERFLY VALVES

OPERATING LIFE

Butterfly valves can operate for more than 10,000 cycles and still provide "bubble tight" shut off. (There are not many valves that can take that kind of punishment).

PRESSURE DROP

Energy costs go up with excessive pressure drop prevalent. Point to keep in mind - the valve or valves are but one factor in a piping system that contribute to pressure drop. Of equal concern are these factors:

- ∞ Flow area of piping
- ∞ Friction loss against pipe walls.
- ∞ Change of flow direction via fittings.
- ∞ Butterfly valve have flow characteristics three times better than globe valves and approximately 75% of an equivalent size gate valve.

VERSATILITY

Butterfly valves can used for on/off service and throttling/balancing. they are superior in "versatility" as compared to a gate or globe valve. Butterfly valves have a wider range of chemical resistance due to the trim options and choice of elastomeric liners.

WEIGHT

Installation of dollars saved with lightweight butterfly valves as compared to heavyweight cast iron valves, ie, a 10" butterfly valve may weigh 490 pounds. This can be an important consideration when it is added up over an entire system. The heavier the system, the stronger the pipe hangers, and the more expensive they become. So, by considering the weight of a valve one can also reduce piping costs.

PHYSICAL SIZE

Butterfly valves take up approximately 1/6 the space of a gate valve. Every cubic foot of a building costs money; ie, 10" butterfly valve is about 21" high, 10" iron gate is about 43" high.

BUBBLE TIGHT SHUT-OFF

Gate and globe (metal to metal) seats cannot provide bubble tight shut-off.

EASE OF OPERATION

Butterfly valves offer 1/4 turn (90 degree) open to close. Gates and globes require multiple turns to open and close. Ease of opening or closing means that butterfly valves can employ less expensive operators.

COST

A butterfly valve is generally 40% the cost of an iron gate. Not only low initial cost but low installation costs also.

MAINTENANCE

Butterfly valves because of their high flow coefficients and resilient seats are virtually self cleaning and are less susceptible to failure due to trash material in the line.

BI-DIRECTIONAL

Butterfly valves are bi-directional and may be installed in either direction.

POSITION

The stem can be installed in any position.

CAUTION

1. Class 250 cast iron and Class 300 steel flanges can not be used on these valve.
2. Rubber faced or mechanical flanges are not recommended
3. This valve is not recommended for steam service.
4. Valves should not be assembled to the flanges and then welded into the piping system.
5. Lever-lock handles are not recommended for use on 8" and larger valves.

Screw and Bolt Data

| VALVE SIZE | ALLBOLTING | | WAFERTYPE | | LUGTYPE | |
|------------|-------------|--------|-------------------------|-------------------------|--------------------|--|
| | DIA | NUMBER | MACHINE BOLTS-LENGTH(A) | MACHINE BOLTS-LENGTH(B) | CAPSCREW-LENGTH(C) | |
| 2" | .625 (5/8") | 4 8 | 4.50 | 5.00 | 1.50 | |
| 2 1/2" | .625 (5/8") | 4 8 | 4.50 | 5.50 | 1.50 | |
| 3" | .625 (5/8") | 4 8 | 4.50 | 5.50 | 1.625 | |
| 4" | .625 (5/8") | 8 16 | 5.00 | 6.50 | 1.875 | |
| 5" | .750 (3/4") | 8 16 | 5.50 | 6.00 | 2.00 | |
| 6" | .750 (3/4") | 8 16 | 5.50 | 8.00 | 2.00 | |
| 8" | .750 (3/4") | 8 16 | 6.00 | 8.50 | 2.25 | |
| 10" | .875 (7/8") | 12 24 | 6.50 | 7.50 | 2.25 | |
| 12" | .875 (7/8") | 12 24 | 7.00 | 7.50 | 2.50 | |

BUTTERFLY VALVES

LUG TYPE



Without Operator 2"-12"



Lever Operator 2"-12"



Gear Operator 2"-4"



Gear Operator 5"-12"



Babbitt Sprocket Rim 2"-12"

| WAFER TYPE WITH LEVER OPERATOR | | | LUG TYPE WITH LEVER OPERATOR | | |
|--------------------------------|----------|-------|------------------------------|----------|-------|
| SIZE | FIG. NO. | PRICE | SIZE | FIG. NO. | PRICE |
| 2 1/2 | 5283 | | 2 1/2 | 5294 | |
| 3 | 5284 | | 3 | 5296 | |
| 4 | 5289 | | 4 | 5297 | |
| 5 | 5290 | | 5 | 5299 | |
| 6 | 5292 | | 6 | 5300 | |
| 8 | 5293 | | 8 | 5303 | |

WAFER TYPE



Without Operator 2"-12"



Lever Operator 2"-12"



Gear Operator 2"-4"



Gear Operator 5"-14"



Babbitt Sprocket Rim 2"-14"

CAUTION

1. Class 250 cast iron and Class 300 steel flanges can not be used on these valve.
2. Rubber faced or mechanical flanges are not recommended
3. This valve is not recommended for steam service.
4. Valves should not be assembled to the flanges and then welded into the piping system.
5. Lever-lock handles are not recommended for use on 8" and larger valves.



SOLENOID VALVES FOR INDUSTRIAL APPLICATIONS

Coil assembly with junction box standard. Other housing available.

Class F coil, UL listed, CSA certified, long life, continuous duty, totally encapsulated, impervious to water, dust and most corrosive fluids

Spring loaded stainless steel plunger for corrosion-free operation. Design permits wide choice of operating positions.

Attractor with copper shading bends for quiet operation. (Silver with stainless steel valves.)

Diaphragm operation for lower pressure drop, better energy savings, greater tolerance of materials. Choice of diaphragm materials for fluid requirements.

Pilot orifice

Available in pipe connections from 1/4" to 3" NPT

Full-ported design permits use of small, less expensive valves.

Solenoid valves are electrically operated devices used to control flow. The valve is used for the remote on/off or directional control of liquids, gases and steam. Solenoid valves do not regulate flow.



OPERATION

Solenoid valves consist of two main elements; 1) an electrical coil (the solenoid), and 2) a valve body or pressure vessel. The solenoid is the electromagnetic unit that powers (acts to open or close) the valve. The valve is the pressure containing unit that acts to shut off or open media flow.

when the solenoid is energized by an electrical signal, current flow results in the build up of magnetic field. The field attracts a moveable plunger in the valve. Physical movement of the plunger opens or closes a valve orifice which give the valve on/off or directional control of media.

In general, solenoid valves are constructed to be 1) direct-acting, and 2) pilot-operated. In a direct-acting valve, the plunger is in direct contact with the body main orifice, and opens or closes the orifice. In a pilot-operated valve the main orifice is not directly controlled by the plunger but by a diaphragm. This diaphragm, covering the main orifice, contains both a pilot and a bleed orifice.

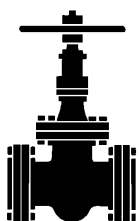

DUFF SUPPLY

FOR ALL YOUR VALVE NEEDS

TYPES OF SOLENOID-PILOT OPERATED

OPERATIONAL SEQUENCE, PILOT OPERATED - (normally-closed)

TO OPEN:

When the solenoid receives an electrical signal a magnetic field is formed which attracts the plunger. The plunger, covering the pilot orifice, lifts off causing system pressure (holding the diaphragm closed) to drop.

As system pressure on top of the diaphragm is reduced, full system pressure on the opposite side of the diaphragm acts to lift the diaphragm away from the main orifice thus allowing full media flow through the valve. Since the bleed orifice is dimensionally small that th pilot orifice, system pressure cannot rebuild on top of the diaphragm as long as the pilot orifice remains open.

TO CLOSE:

When the solenoid is de-energized it releases its hold on the plunger. The plunger drops and covers the pilot orifice. System pressure then builds orifice, forcing the diaphragm down until it covers the main orifice and stops media flow through the valve.

OPERATIONAL SEQUENCE, PILOT-OPERATED (normally open)

In a normally-open valve, the sequence of operation is reversed from that of a normally closed valve, the main orifice is open when the solenoid is de-energized. All other relationships (eg, the size relationship between the pilot and bleed orifice) still apply.

TO OPEN

When the solenoid is de-energized it releases its hold on the plunger. The plunger uncovers the pilot orifice causing system pressure holding the diaphragm closed to drop. As system pressure on top of the diaphragm is reduced, full system pressure on the opposite side of the diaphragm acts to lift the diaphragm away from the main orifice thus allowing full media flow through the valve.

TO CLOSE

When the solenoid is energized it attracts the plunger. The plunger covers the pilot orifice. System pressure then builds up on the top of the diaphragm through the bleed orifice, forcing the diaphragm down until it covers the main orifice and stops media flow through the valve.

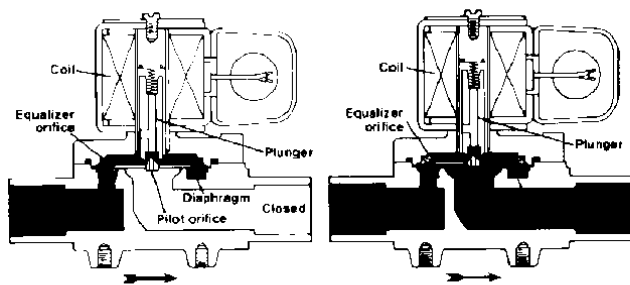

Coil De-energized, Valve Closed Coil Energized, Valve Open

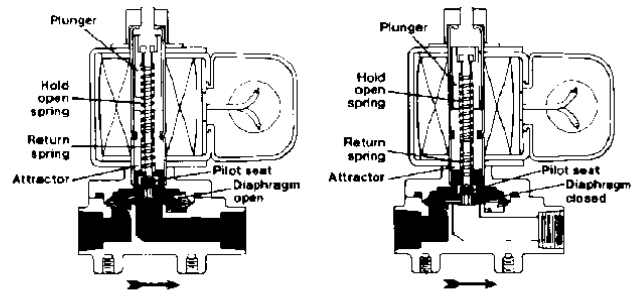

Coil De-energized, Valve Open Coil Energized, Valve Closed

INSTALLATION INSTRUCTIONS

Proper flow direction is indicated by an arrow on the valve body. The ideal installation is in a horizontal line with the coil located directly on top of the valve. However, solenoid valves may be installed in any position as long as the coil assembly is never lower than the centerline of the valve body.

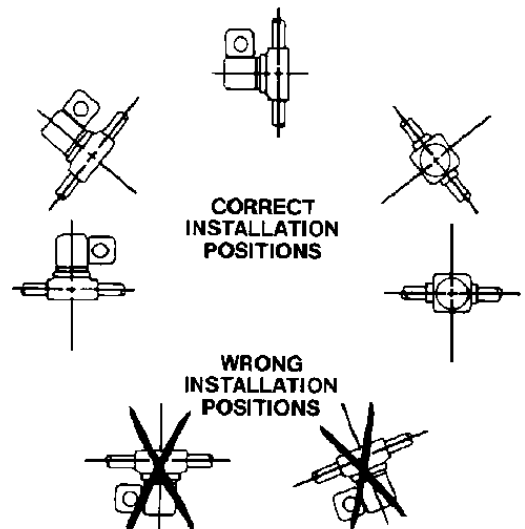

SOLENOID VALVES



1/4 to 1

Minimum pressure = 1 Lbs.
Maximum pressure = 150 Lbs.
Maximum Temp = 225° F



1 1/4 to 1 1/2

Minimum pressure = 5 Lbs.
Maximum pressure = 125 Lbs.
Maximum Temp = 180° F



2 to 3

Minimum pressure = 2 Lbs.
Maximum pressure = 125 Lbs.
Maximum Temp = 180° F

NORMALLY CLOSED VALVES

| SIZE | VALVE ONLY | | VALVE WITH 24 VOLT COIL | | VALVE WITH 110-120 VOLT COIL | | VALVE WITH 240 VOLT COIL | |
|-------|------------|-------|-------------------------|-------|------------------------------|-------|--------------------------|-------|
| | FIG. NO. | PRICE | FIG. NO. | PRICE | FIG. NO. | PRICE | FIG. NO. | PRICE |
| 1/4 | 38741 | | 45197 | | 45195 | | 45196 | |
| 3/8 | 38742 | | 45200 | | 45198 | | 45199 | |
| 1/2 | 38743 | | 45206 | | 45201 | | 45202 | |
| 3/4 | 38744 | | 45209 | | 45207 | | 45208 | |
| 1 | 38745 | | 45212 | | 45210 | | 45211 | |
| 1 1/4 | 38746 | | 45230 | | 45222 | | 45229 | |
| 1 1/2 | 41399 | | 45233 | | 45231 | | 45232 | |
| 2 | 38748 | | 45215 | | 45213 | | 45214 | |
| 3 | 38750 | | 45221 | | 45219 | | 45220 | |

NORMALLY CLOSED SOLENOID VALVE WITH "O DIFFERENTIAL"

MINIMUM PRESSURE = 0#

MAXIMUM PRESSURE = 150#

MAXIMUM TEMPERATURE = 180 F.

****LESS COIL****

| SIZE | FIG NO | PRICE |
|------|--------|-------|
| 3/8 | 49191 | |
| 1/2 | 45249 | |
| 3/4 | 45250 | |

YOU MUST ORDER A COIL WITH THESE VALVES!!

NORMALLY OPEN VALVE LESS COIL

| SIZE | FIG NO | PRICE |
|------|--------|-------|
| 1/2 | 44216 | |
| 3/4 | 44217 | |

SOLENOID VALVES

STEAM SOLENOID VALVES

Maximum steam pressure 50PSIG
 Minimum pressure 1 LB
 Maximum pressure 50 LB
 Maximum temperature 360°F



| STEAM SOLENOID VALVES - NORMALLY CLOSED | | | | | | | | |
|---|------------|-------|-------------------------|-------|------------------------------|-------|--------------------------|-------|
| | VALVE ONLY | | VALVE WITH 24 VOLT COIL | | VALVE WITH 110-120 VOLT COIL | | VALVE WITH 220 VOLT COIL | |
| SIZE | FIG. NO. | PRICE | FIG. NO. | PRICE | FIG. NO. | PRICE | FIG. NO. | PRICE |
| 1/4 | 38751 | | 45235 | | 45236 | | 45234 | |
| 3/8 | 38752 | | 45239 | | 45237 | | 45238 | |
| 1/2 | 38753 | | 45242 | | 45240 | | 45241 | |
| 3/4 | 38754 | | 45245 | | 45243 | | 45244 | |
| 1 | 38755 | | 45248 | | 45246 | | 45247 | |

THREE-WAY SOLENOID - NORMALLY CLOSED

| SIZE | FIG NO | PRICE |
|------|--------|-------|
| 1/2 | 49058 | |



* OTHER SIZES AVAILABLE!

COILS

| VOLTAGE | FIG. NO. | PRICE |
|---------|----------|-------|
| 24 | 45226 | |
| 110-120 | 45227 | |
| 208-240 | 45228 | |

ALL GATE, GLOBE, CHECK, AND BALL VALVES CAN BE CHROME PLATED!

LUBRICATED PLUG VALVES



| STRAIGHTWAY (THREADED) | | | | | FLANGED VALVE | | | |
|------------------------|----------|--------|----------|-------|---------------|--------|----------|-------|
| VALVE | | WRENCH | | VALVE | | WRENCH | | |
| SIZE | FIG. NO. | PRICE | FIG. NO. | PRICE | FIG. NO. | PRICE | FIG. NO. | PRICE |
| 1 | 5086 | | 5105 | | 5095 | | 5105 | |
| 1 1/4 | 5087 | | 5106 | | 5096 | | 5106 | |
| 1 1/2 | 5090 | | 5106 | | 5097 | | 5106 | |
| 2 | 5091 | | 5106 | | 5098 | | 5106 | |
| 2 1/2 | 5092 | | 5104 | | 5099 | | 5104 | |
| 3 | 5093 | | 5104 | | 5100 | | 5104 | |
| 4 | 5094 | | 5107 | | 5101 | | 5107 | |
| 5 | - | | - | | 5102 | | 5108 | |
| 6 | - | | - | | 5103 | | 5108 | |

OTHER PATTERN PLUG VALVES



PLUG VALVE
LUBRICANT
AVAILABLE

HOMESTEAD[®] VALVES



Rockwell

→ OXYGEN

ALL VALVES (BALL, GATE,
GLOBE AND CHECK) CAN BE
CLEANED FOR
OXYGEN SERVICE!

DIAPHRAGM VALVES

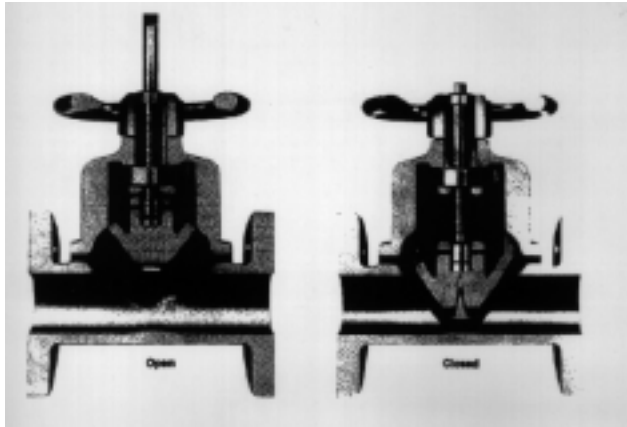

VISCOUS
FLUIDS
ABRASIVES
FIBROUS
SLURRIES
SLUDGES
SUSPENDED
SOLIDS

WITH NO METAL TO
METAL
CONTACT
ONLY THE
GASKET COMES IN
CONTACT WITH
FLUID

Hundreds of combinations of body material, linings, end connections and types combined with diaphragm selection and modes of operation, add up to thousands of possible combinations while eliminating any metal to metal contacts.

| LINING MATERIAL | FLANGED PLASTIC LINED | | | FLANGED RUBBER LINED | | | FLANGED LINED ANGLE | |
|---------------------|-----------------------|--------------|------------|----------------------|--------------|-----------|---------------------|------|
| | CAST IRON | DUCTILE IRON | CAST STEEL | CAST IRON | DUCTILE IRON | CAST IRON | DUCTILE IRON | IRON |
| PVC | X | | | | | | | |
| SARAN | X | X | X | | | | | |
| POLYPROPYLENE | X | X | X | | | | | |
| TEFZEL | X | X | X | | | | | |
| KYNAR | | X | | | | | | |
| NEOPRENE #7 | | | | X | X | | | X |
| SOFT RUBBER #5 | | | | X | X | | | X |
| hARD RUBBER #10 | | | | X | X | | | X |
| BUTYL #16 | | | | X | | | | |
| HYPALON #9 | | | | X | | | | |
| SOFT GUM RUBBER #11 | | | | X | | | | |
| #S471 | | | | X | | | | |
| GLASS | | | | X | | X | X | X |

DIAPHRAGM OPTIONS:

Gum rubber, black butyl, hypalon, ethylene propylene, buna N, natural rubber, neoprene, viton, white buty TFE

FOR SPECIFIC APPLICATIONS, LET OUR VALVE CONSULTANTS ASSIST YOU IN SELECTING PROPER BODIES, LININGS AND DIAPHRAGMS TOO NUMEROUS TO DETAIL!



KNIFE GATE VALVE

Duff Company now offers the industry a versatile line of knife gate valves that can meet your highest quality and engineering standards. We can customize this line of valves to meet diverse customer needs - manual, electric, hydraulic, and pneumatic actuation are available in a wide variety of accessories.

FIG. NO. DCG



MANUALLY OPERATED PINCH VALVES

Ideal for reliable operation and long life on a variety of tough slurries, abrasives and chemicals, because the flexible rubber sleeve is the only part exposed to abrasion. they will outlast gate, ball or plug valves whose metal seats will wear quickly.

FIG. NO. DC75

QUICK OPENING BOILER VALVES



| SIZE | FIG NO | PRICE |
|-------|--------|-------|
| 3/4 | 17601 | |
| 1 | 5263 | |
| 1 1/4 | 5264 | |
| 1 1/2 | 5266 | |
| 2 | 5268 | |
| 2 1/2 | 5270 | |



HOW FIGURE 4000 SERIES OPERATES

Line pressure and heavy spring hold disc firmly against the body seat, sealing off the flow. When operated, the disc slides across the body seat pushing harmful boiler scale away, and wiping clean the precision lapped surfaces.

Hand adjustment of the post packing is eliminated. Post packing is self-adjusted by a spring and line pressure. This prevents destructive erosion or leakage of stuffing box.

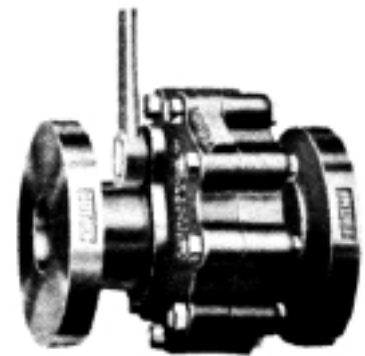

FEATURES

- *Straight through flow
- *Leak proof seal disc has self lapping action, actually improves with use
- *Self wiping action of disc cannot hang up on boiler scale.

SLOW OPENING VALVES
(meet ASME/ANSI codes)



FEATURES

- Valve can be installed with hand wheel in any position.
- Straight through-flow
- Leakproof seal-disc has self lapping action, actually improves with use.
- Seal-disc has wiping action: cannot hang-up on boiler scale.
- No retightening after cool down; seal not affected by temperature change.
- Real slow opening
- Hard seat (700 BHN)resists erosion

HOW THIS VALVE OPERATES

Line pressure and heavy spring hold disc firmly against the body seat, sealing off the flow. When operated, the disc slides across the body seat pushing harmful boiler scale away, and wiping clean the precision lapped surfaces.

Hand adjustment of the post packing is eliminated. Post packing is self-adjusted by a spring and line pressure. This prevents destructive erosion or leakage of stuffing box.

SLOW OPENING VALVES
(meet ASME/ANSI codes)



Sectional view of Angle and "Y" valve

HOW THIS VALVE OPERATES

These valves are of the outside screw and yoke type. The seat and disc are capable of withstanding the severe erosive flow of blow-down service. While quick opening valve holds boiler water, the seat and disc can be easily removed for repair without removing the valve form the line.

BLOW OFF VALVES



ANGLE VALVE FLANGE
 *Iron bodyron Bod
 *Steel Body



ANGLE VALVE SCREWED
 *Iron Body
 *Steel Body



STRAIGHTWAY VALVE - SCREWED
 *Iron Body
 *Steel Body



STRAIGHTWAY VALVE FLANGED
 *Iron Body
 *Steel Body

FIRE PROTECTION VALVES

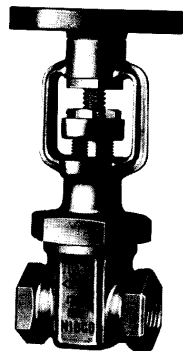

- * 175 LB WWP Bronze Gate
- * Threaded
- * UL/ULC listed
- * FM approved
- * Block pattern
- * Screw-over bonnet
- * Outside screw and yoke
- * Solid wedge
- * 175 PSI non-shock cold water (400 psi non-shock WOG general service)
- * Approved by the New York City Board of Standards.

FIG. NO. DCT1040

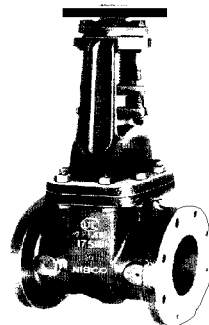

- * 175 LB WWP Iron Body Gate
- * Flanged
- * UL/ULC listed
- * FM approved
- * Bolted bonnet
- * Outside screw and yoke
- * Solid wedge
- * Pre-grooved stem for tamper switch mounting.
- * 175 psi non-shock cold water
- * Approved by the New York City board of Standards and Appeals

FIG. NO. DCF607OTS

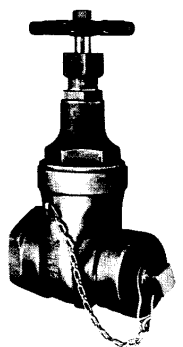

- * 175 LB WWP Bronze hose Gate
- * Threaded with cap and chain
- * UL listed
- * FM approved
- * Screw in bonnet
- * Non-rising stem
- * Solid wedge
- * 175 PSI non-shock cold water
- * Female NPT inlet x Male thread hose outlet

| SIZE | FIG NO | PRICE |
|-----------|--------|-------|
| 1 1/2 | 83706 | |
| 2 1/2 | 83707 | |
| 3 X 2 1/2 | 83708 | |

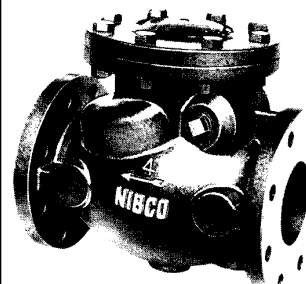

- * 175 LB WWP iron body check
- * Flanged
- * UL/ULC listed
- * FM approved
- * Bolted bonnet
- * Horizontal Swing
- * Renewable seat and disc
- * 175 PSI non-shock cold water
- * Approved by the New York City board of Standards and Appeals

FIG. NO. DCF908W

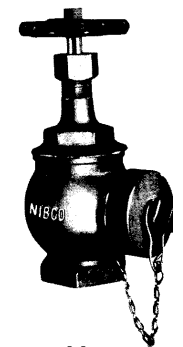

- * 300 LB WWP Bronze Hose Gate
- * Threaded with cap and chain
- * UL listed
- * FM approved
- * Screw in bonnet
- * Rising stem
- * Screw-in bonnet
- * 300 PSI non-shock cold water

| SIZE | FIG NO | PRICE |
|-------|--------|-------|
| 1 1/2 | 83690 | |
| 2 1/2 | 83692 | |



- * 1/2" Automatic Ball Drip
- * For installation on DCF908W
- * Closes against pressure
- * Opens when pressure is off, allowing water to drain from the fire department connection

FIG. NO. DCBALLDRIP

FOR ADDITIONAL FIRE PROTECTION VALVES, SEE PAGES 143-148

FORGED STEEL VALVES

PRESSURE-TEMPERATURE RATINGS FOR FORGED STEEL GLOBE, GATE AND CHECK VALVES

| TYPE OF ENDS | FLANGED(1) | | | THREADED OR SOCKET WELD(2) |
|-------------------------------|-----------------------|-----|------|----------------------------|
| MATERIAL | ASTMA105 CARBON STEEL | | | CARBON OR STAINLESS STEEL |
| TEMPERATURE DEGREES F. (3) | CLASS | | | CLASS |
| | 150 | 300 | 600 | 800 |
| -20 TO 100 | 275 | 720 | 1440 | 2000 |
| 150 | 255 | 710 | 1420 | 1970 |
| 200 | 240 | 700 | 1400 | 1940 |
| 250 | 225 | 690 | 1380 | 1915 |
| 300 | 210 | 680 | 1365 | 1895 |
| 350 | 195 | 675 | 1350 | 1875 |
| 400 | 180 | 665 | 1330 | 1850 |
| 450 | 165 | 650 | 1305 | 1810 |
| 500 | 150 | 625 | 1250 | 1735 |
| 550 | 140 | 590 | 1180 | 1640 |
| 600 | 130 | 555 | 1110 | 1540 |
| 650 | 120 | 515 | 1030 | 1430 |
| 700 | 110 | 470 | 940 | 1305 |
| 750 | 100 | 425 | 850 | 1180 |
| 800 | 92 | 365 | 730 | 1015 |
| 850 | 82 | 300 | 600 | 800 |
| 900 | 70 | 225 | 445 | 600 |
| 950 | 55 | 155 | 310 | 425 |
| 975 | 50 | 120 | 240 | - |
| 1000 | 40 | 85 | 170 | 235 |

FORGED STEEL VALVES



OS&Y gates. Threaded and socket weld ends 800 psi 850 degrees F. welded bonnet.



OS&Y globe integrally forged flanged ends class 300 and 600 bolted bonnet



OS&Y globes threaded and socket weld ends class 800 bolted bonnet



OS&Y gates, class 800 threaded, socket weld and female threaded for socket weld ends bolted bonnet.



Lift check threaded and socket weld ends class 800 bolted cover



OS&Y gates. class 150, 300, 600 integrally forged flanged ends. Bolted Bonnet.



Ball valves with TFE seats and packing, adjustable packing box.

| SIZE | FIG NO | PRICE |
|-------|--------|-------|
| 1/4 | 5271 | |
| 3/8 | 5273 | |
| 1/2 | 5274 | |
| 3/4 | 5276 | |
| 1 | 5277 | |
| 1 1/4 | 5279 | |
| 1 1/2 | 5280 | |
| 2 | 5281 | |

**DUFF
DELIVERS!**

FORGED STEEL VALVES (ALL TYPES) AVAILABLE IN CLASSES 600, 800, 1500, 2500 AND 4500 (IE, 10,000 LBS).





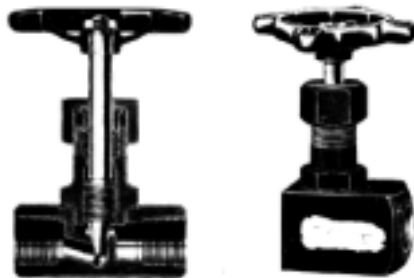



JENKINS, VOGHT, RP&C, BONT, SMITH AND OTHER MANUFACTURERS AVAILABLE.

BAR STOCK NEEDLE VALVES

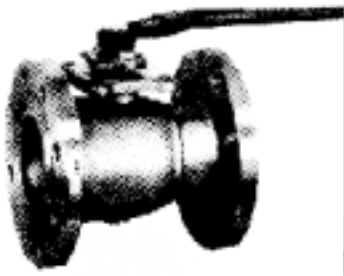

| BRONZE | CARBON STEEL | STAINLESS STEEL |
|--|---|-----------------------------|
| 1/8" - 1/2" | 1/8" - 1" | 1/8" - 1/2" |
| Fig 1030 globe, 1031 angle (500 lbs @ 150 degrees F) | Fig 1040A globe Fig 1041 angle 10,000 lbs @ 150 degrees F | (5000 lbs @ 150 degrees F.) |
| Fig 1035 globe, 1036 angle (4000 lbs) | | |

STAINLESS STEEL VALVES
**CHOOSE FROM OUR FULL LINE
 OF HIGH QUALITY VALVES
 TO MEET YOUR NEEDS**

|  <p>Threaded Gate Valve</p> |  <p>Threaded Globe Valve</p> |  <p>Threaded Swing Check Valve</p> | | | | | | | | | | | | | | | | | | | | | | | | | | | |
|--|---|---|------|--------|-------|-----|------|--|-----|------|--|---|------|--|-------|------|--|-------|------|--|---|------|--|-------|-------|--|---|-------|--|
|  <p>Threaded Ball Valve</p> |  <p>Threaded Full Port Ball Valve</p> | <table border="1"> <thead> <tr> <th>SIZE</th> <th>FIG NO</th> <th>PRICE</th> </tr> </thead> <tbody> <tr> <td>1/2</td> <td>5250</td> <td></td> </tr> <tr> <td>3/4</td> <td>5252</td> <td></td> </tr> <tr> <td>1</td> <td>5254</td> <td></td> </tr> <tr> <td>1 1/4</td> <td>5255</td> <td></td> </tr> <tr> <td>1 1/2</td> <td>5256</td> <td></td> </tr> <tr> <td>2</td> <td>5257</td> <td></td> </tr> <tr> <td>2 1/2</td> <td>58964</td> <td></td> </tr> <tr> <td>3</td> <td>61785</td> <td></td> </tr> </tbody> </table> | SIZE | FIG NO | PRICE | 1/2 | 5250 | | 3/4 | 5252 | | 1 | 5254 | | 1 1/4 | 5255 | | 1 1/2 | 5256 | | 2 | 5257 | | 2 1/2 | 58964 | | 3 | 61785 | |
| SIZE | FIG NO | PRICE | | | | | | | | | | | | | | | | | | | | | | | | | | | |
| 1/2 | 5250 | | | | | | | | | | | | | | | | | | | | | | | | | | | | |
| 3/4 | 5252 | | | | | | | | | | | | | | | | | | | | | | | | | | | | |
| 1 | 5254 | | | | | | | | | | | | | | | | | | | | | | | | | | | | |
| 1 1/4 | 5255 | | | | | | | | | | | | | | | | | | | | | | | | | | | | |
| 1 1/2 | 5256 | | | | | | | | | | | | | | | | | | | | | | | | | | | | |
| 2 | 5257 | | | | | | | | | | | | | | | | | | | | | | | | | | | | |
| 2 1/2 | 58964 | | | | | | | | | | | | | | | | | | | | | | | | | | | | |
| 3 | 61785 | | | | | | | | | | | | | | | | | | | | | | | | | | | | |
|  <p>Flanged Swing Check Valve</p> |  <p>Flanged Ball Valve</p> |  <p>Flanged Gate Valve</p> | | | | | | | | | | | | | | | | | | | | | | | | | | | |

YES!

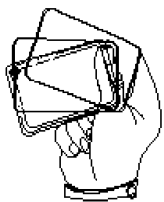

**WE ACCEPT
 VISA AND
 MASTERCARD!**



IRON BODY AWWA VALVES



AWWA inside screw, non-rising stem, bronze trim, solid wedges, O-ring gland, square operating nut.

Conforms to AWWA specifications and has identifying AWWA cast on bonnet. Generally recommended for shut-off on water lines.

☉200 psi water, 4"-12": 175 psi 14": 150 psi 16"-20"

TYPE OF ENDS:

tyton, 4"-12"

Flanged X Mechanical Joint, 4"-12"

Mechanical Joint, 4"-20"

Flanged X Tyton, 4" - 12"

Flanged X Ring - Tite, 4"-12"



AWWA inside screw, non-rising stem, bronze trim, solid wedges, Wheel operated

This valve contained flanged ends. Sizes up to 20" fitted with O-ring gland. larger sizes have conventional packing box.

☉200 psi water, 4"-12"

☉175 psi water 14"

☉150 psi water 16"-48"

Flanged, 4"-10"

Flanged, 24" - 48"

IRON BODY AWWA BUTTERFLY VALVES

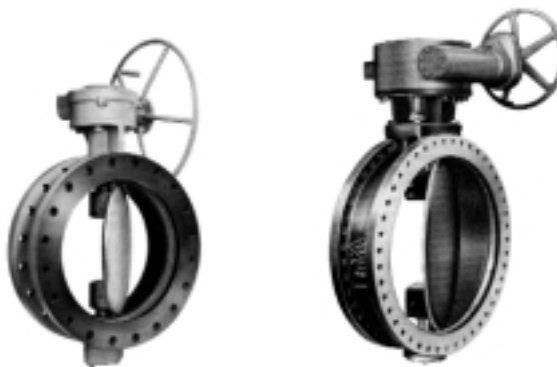

These butterfly valves are manufactured to AWWA C-5604 specifications and are available with various types of ends in a full range of pressures and velocity with manual, electric, hydraulic, or pneumatic actuators. Positioners for flow regulation and actuators with special features to suit individual requirements can also be supplied.

The rubber seat is precision molded of natural rubber and constructed so that it can be accurately adjusted over 360 degrees seating surface to endure bubble-tight shut-off on pressures to a maximum rating of 250 psig.

Optional materials are available for special services and pressure applications.

VALVES FOR TODAY'S MODERN TANKS

GATE VALVE
Steel, Stainless Steel and Aluminum

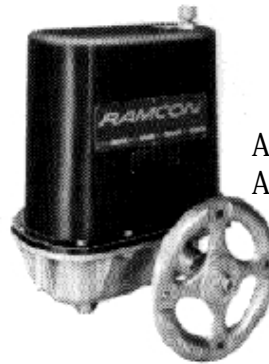

API BOTTOM LOADING ADAPTER

FLANGED EMERGENCY VALVE
Steel and Stainless Steel



DELMAR EMERGENCY VALVE
Aluminum



MONARCH AIR CHECK VALVE



UNIVERSAL EMERGENCY VALVE OPERATOR

MOUNTING BRACKETS



MOUNTING BRACKETS

☛ Mounting brackets and couplings are available in a wide variety of configurations to suit specific applications.

PNEUMATIC ACTUATORS



PNEUMATIC ACTUATORS

Many basic models - air to close; air to open, spring to close, air to close, spring to open
☛ Choice of double-acting or spring-return fail-safe models.

VALVE ACTUATORS



ELECTRIC ACTUATOR

Many basic models - brushless induction motors
☛ 35 45,000 lb-in. rated torque outputs
☛ 2 to 20 second standard cycle speeds (90 degree travel). Special cycle time also available
☛ Reversible models precision adjustable up to 260 degrees rotation
☛ All models are available unidirectional.

ADD-A-VALVE

DIMENSIONS IN INCHES

| VALVE SIZE | A | B | C | OPEN | CLOSED |
|------------|------|------|------|-------|--------|
| 1/2" | 3.83 | 1.96 | .62 | 5.86 | 4.37 |
| 3/4" | 4.76 | 2.28 | .87 | 7.28 | 5.00 |
| 1" | 5.66 | 2.63 | 1.12 | 8.81 | 6.29 |
| 1-1/4" | 6.93 | 3.27 | 1.37 | 10.59 | 7.55 |
| 1-1/2" | 7.89 | 3.62 | 1.62 | 12.08 | 8.54 |
| 2" | 9.98 | 4.44 | 2.12 | 15.15 | 10.59 |

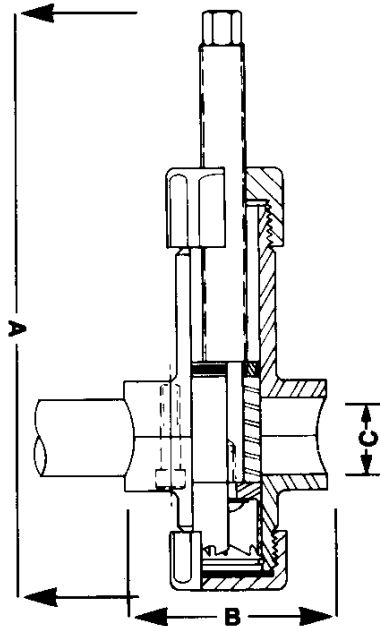

**ADD A VALVE WITH-
OUT
SHUTTING OFF THE
WATER...
IN 30
SECONDS OR LESS!**

Designed for use on L&K type copper tubing - on cold water systems only, ADD-A-VALVE is not recommended for type M or thinner wall copper tubing and carries absolutely no guarantee!

To install the ADD-A-VALVE under pressure, on L or K type copper tubing without shutting off the water, simply disassemble the ADD-A-VALVE body by removing the (4) SS316 allen screws. Brush a thin coat of Jomar Seal WOG, hard set, thread sealant on the inner surface of both ADD-A-VALVE cavities, the width of both valve bodies and allow to dry for three minutes, then assemble the ADD-A-VALVE around the copper tubing. Reinsert the 4 allen screws and tighten evenly in an X pattern to align the ADD-A-VALVE body evenly on the

copper tubing. Use a 3.9" manual, ratchet type, socket wrench on the 1/2", 3/4" and 1" sizes and a 9/16" on the 1 1/4", 1 1/2" and 2" sizes to drive the finely threaded 316SS stem and cutter assembly down until you have through both wall of the copper tubing. the stem and cutter assembly will then seat inside the body cavity on the newly designed internal shut off stop. CONTINUE TO MANUALLY RATCHET THE SOCKET WRENCH AN ADDITIONAL 1 AND 1/2 TURNS TO EXPAND THE VITON SEAL. The above process, if properly executed will completely seal off the water flow in he copper tubing under pressure from 0 psi to 145 psi. next remove the cleanout cap at the bottom of the valve body, if there is a leak, tighten down the steam assembly until the flow of water stops. Remove the two (2) copper wall slugs with a pair of needle nose pliers, making sure that both the inside of the cutter and the cleanout cap are free of all debris by opening the valve and flushing out the line into a light plastic bucket suspended on the copper line with an "S" hanger. Reinsert the cleanout cap into the valve body and tighten. Once you have replaced the defective valve or installed a new ball valve down stream, you may fully open the ADD-A-VALVE by reversing the stem with a Makita type battery powered drill or by using a manual socket wrench and backing out the stem until a full water flow is restored to the line. The ADD-A-VALVE is now a permanent part of the copper tube installation. THE CLEANOUT CAP SERVES AS A LINE TAP BY ADDING AN ADAPTER.

**DURABLE
Basic check valves**

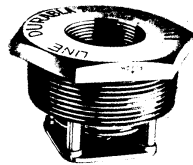

Silent, sure, shockproof piping system protection. Stainless steel, 300 lb, WSP at 500 degrees Fahrenheit. Combines with almost any standard pipe fitting, forms a complete check valve suitable for practically all services - oil, water, refrigerants, light hydrocarbons, gas and steam. They can also operate in any position. Operates easily with low pressure drop, closes positively without leakage in any position. **AVAILABLE 3/4" TO 2"**

BABBIT SPROCKET RIMS

brings high valves
within reach

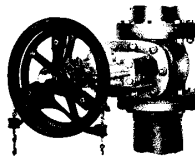

BABBIT ADJUSTABLE SPROCKET RIMS WITH CHAIN GUIDE: Overhead or inaccessible valves, when equipped with this devise, may be conveniently and safely operated from the floor. Attached directly to hand wheels, the adjustable sprocket rim with chain guide can be quickly and easily installed. Rims and guides are available in cast or ductile iron.

| SIZE | FIG NO | DIA OF SPROCKET WHEEL | WEIGHT IN LBS. | DIA OF VALVE WHEELS RIM WILL FIT | CHAIN SIZE NO | CHAIN WEIGHT PER 100 LBS. |
|-------|---------|-----------------------|----------------|----------------------------------|---------------|---------------------------|
| 0 | DCBS0 | 4 | 2 | 2-4 | 1 | 10 |
| 1 | DCBS1 | 5 7/8 | 4 | 4 1/8-5 7/8 | 2 | 17 1/2 |
| 1 1/2 | DCBS112 | 7 1/2 | 5 | 6-7 1/2 | 2 | 17 1/2 |
| 2 | DCBS2 | 9 | 8 | 7 3/4-9 | 2 | 17 1/2 |
| 2 1/2 | DCBS212 | 12 1/2 | 15 | 9 1/4-12 1/2 | 3 | 30 |
| 3 | DCBS3 | 15 1/2 | 21 | 12 3/4-15 1/2 | 3 | 30 |
| 3 1/2 | DCBS312 | 19 | 25 | 15 3/4-19 | 3 | 30 |

For additional information call: 610-275-4453 or Fax: 610-279-6299
Please call for current prices.

CAST STEEL VALVES



CLASS 150 GATE O.S.&Y.,
BOLTED BONNET FLEXIBLE
AND SOLID WEDGE

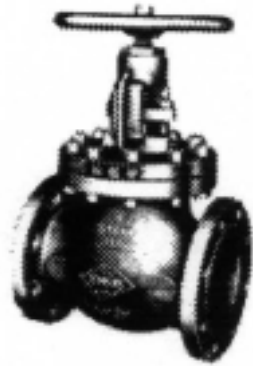

CLASS 150 GLOBE O.S.&Y.,
BOLTED
BONNET



CLASS 150 SWING CHECK
BOLTED COVER

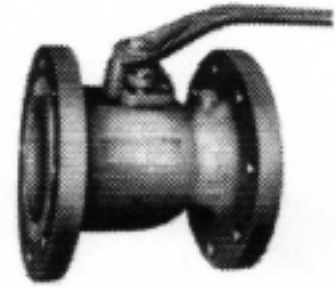

CLASS 150 BALL VALVE TWIN SEAL,
TFE SEATS

CRYOGENIC VALVES

FAX YOUR ORDER!
610-275-4453

*GATE, GLOBE AND CHECK VALVES
(THREADED AND FLANGED) IN
BRONZE AND STAINLESS*

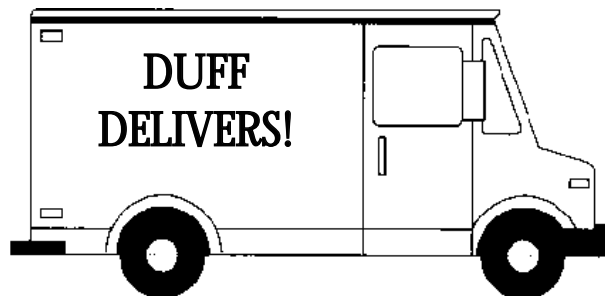

FITTINGS AND PIPE

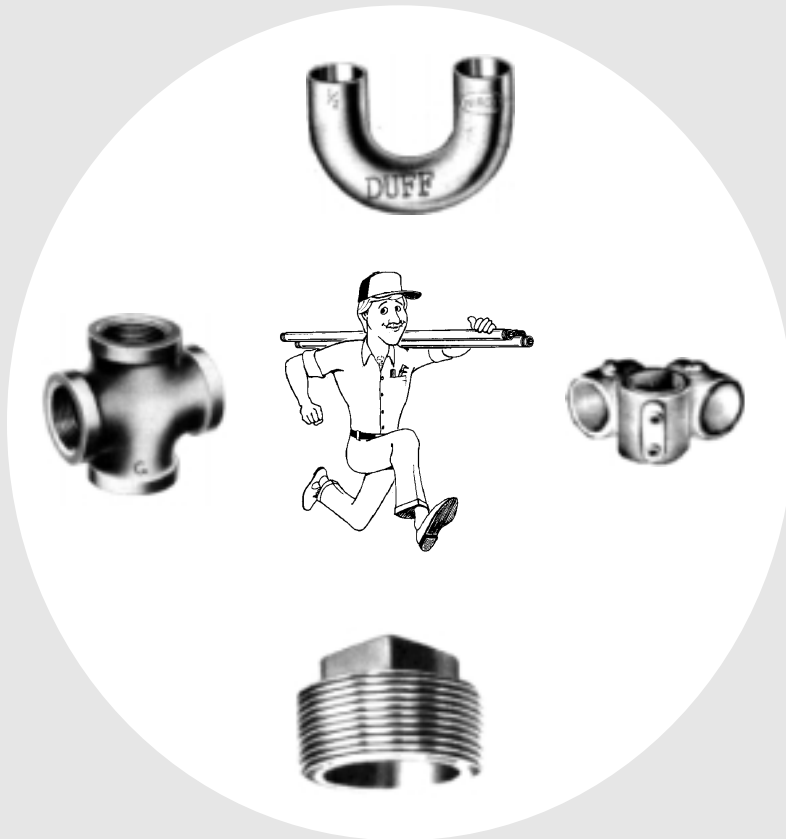

FITTINGS AND PIPE



150 LB. MALLEABLE IRON PIPE FITTINGS



90° ELBOW



90° STREET ELBOW



45° ELBOW



45° STREET ELBOW

| SIZE | 90° ELBOW | | 90° STREET ELBOW | | 45° ELBOW | | 45° STREET ELBOW | | |
|----------|-----------|------------|------------------|------------|-----------|------------|------------------|------------|-------|
| | Black | Galvanized | Black | Galvanized | Black | Galvanized | Black | Galvanized | |
| FIG. NO. | PRICE | FIG. NO. | PRICE | FIG. NO. | PRICE | FIG. NO. | PRICE | FIG. NO. | PRICE |
| 1/8 | 458 | 713 | 493 | 756 | 505 | 744 | 517 | 768 | |
| 1/4 | 459 | 714 | 494 | 757 | 506 | 745 | 518 | 769 | |
| 3/8 | 460 | 715 | 495 | 758 | 507 | 746 | 519 | 770 | |
| 1/2 | 461 | 716 | 496 | 759 | 508 | 747 | 520 | 771 | |
| 3/4 | 462 | 717 | 497 | 760 | 509 | 748 | 521 | 772 | |
| 1 | 463 | 718 | 498 | 761 | 510 | 749 | 522 | 773 | |
| 1 1/4 | 464 | 719 | 499 | 762 | 511 | 750 | 523 | 774 | |
| 1 1/2 | 465 | 720 | 500 | 763 | 512 | 751 | 524 | 775 | |
| 2 | 466 | 721 | 501 | 764 | 513 | 752 | 525 | 776 | |
| 2 1/2 | 467 | 722 | 502 | 765 | 514 | 753 | - | - | |
| 3 | 468 | 723 | 503 | 766 | 515 | 754 | - | - | |
| 3 1/2 | 21846 | 32458 | - | - | - | - | - | - | |
| 4 | 469 | 724 | 504 | 767 | 516 | 755 | - | - | |
| 5 | 5530 | 32469 | - | - | 5536 | 32470 | - | - | |
| 6 | 5531 | 11878 | - | - | 5537 | 32471 | - | - | |



TEE



STREET TEE



CROSS



LATERAL

| SIZE | TEE | | STREET TEE | | CROSS | | LATERAL | | |
|----------|-------|------------|------------|------------|-------|------------|---------|------------|-------|
| | Black | Galvanized | Black | Galvanized | Black | Galvanized | Black | Galvanized | |
| FIG. NO. | PRICE | FIG. NO. | PRICE | FIG. NO. | PRICE | FIG. NO. | PRICE | FIG. NO. | PRICE |
| 1/8 | 538 | 777 | - | - | 603 | 11898 | - | - | |
| 1/4 | 539 | 778 | 13804 | 32554 | 604 | 11899 | - | - | |
| 3/8 | 540 | 779 | 13805 | 32555 | 605 | 11901 | 11594 | 20026 | |
| 1/2 | 541 | 780 | 13806 | 26506 | 606 | 816 | 11595 | 20027 | |
| 3/4 | 542 | 781 | 13807 | 26507 | 607 | 817 | 11597 | 20028 | |
| 1 | 543 | 782 | 13808 | 26509 | 608 | 818 | 11598 | 20029 | |
| 1 1/4 | 544 | 783 | 13809 | 26510 | 609 | 819 | 11599 | 20030 | |
| 1 1/2 | 545 | 784 | 13810 | 26511 | 610 | 820 | 11600 | 20031 | |
| 2 | 546 | 785 | - | 26512 | 611 | 11883 | 11602 | 20032 | |
| 2 1/2 | 547 | 786 | - | - | 11589 | 11884 | 11604 | 20033 | |
| 3 | 548 | 787 | - | - | 11591 | 11887 | 11605 | 20034 | |
| 3 1/2 | 22521 | 32478 | - | - | - | - | - | - | |
| 4 | 549 | 788 | - | - | 11592 | 11890 | 13796 | 20036 | |
| 5 | 5541 | 32479 | - | - | - | - | - | - | |
| 6 | 5542 | 11880 | - | - | 11593 | 11893 | - | - | |

For additional information call: 610-275-4453 or Fax: 610-279-6299
Please call for current prices.

150 LB. REDUCING FITTINGS



| SIZE | 90° Elbow | | Coupling | | | | Bushing | | | | Face Bushing | | | | | |
|-------------|-----------|-------|----------|-------|---------|-------|---------|-------|---------|-------|--------------|-------|---------|-------|---------|-------|
| | BLACK | | GALV | | BLACK | | GALV | | BLACK | | GALV | | BLACK | | GALV | |
| | FIG NO. | PRICE | FIG NO. | PRICE | FIG NO. | PRICE | FIG NO. | PRICE | FIG NO. | PRICE | FIG NO. | PRICE | FIG NO. | PRICE | FIG NO. | PRICE |
| 1/4x1/8 | 470 | | 725 | | 612 | | 829 | | 1089 | | 903 | | 32404 | | - | |
| 3/8x1/8 | 471 | | 5583 | | 614 | | 830 | | 1090 | | 904 | | - | | 32588 | |
| 3/8x1/4 | 472 | | 726 | | 613 | | 831 | | 1091 | | 905 | | 32406 | | 32589 | |
| 1/2x1/8 | - | | - | | 615 | | 832 | | 1092 | | 906 | | - | | - | |
| 1/2x1/4 | 474 | | 728 | | 616 | | 833 | | 1093 | | 907 | | - | | 32590 | |
| 1/2x3/8 | 473 | | 727 | | 617 | | 834 | | 1094 | | 908 | | 1151 | | 32591 | |
| 3/4x1/8 | - | | - | | 618 | | 20714 | | 1095 | | 909 | | - | | - | |
| 3/4x1/4 | 475 | | 32459 | | 619 | | 835 | | 1096 | | 910 | | - | | - | |
| 3/4x3/8 | 476 | | 730 | | 620 | | 836 | | 1097 | | 911 | | - | | 32592 | |
| 3/4x1/2 | 477 | | 729 | | 621 | | 837 | | 1098 | | 912 | | 1152 | | 32593 | |
| 1x1/8 | - | | - | | 5570 | | - | | 1099 | | 5590 | | - | | - | |
| 1x1/4 | - | | - | | 622 | | 23273 | | 1100 | | 913 | | - | | - | |
| 1x3/8 | 11588 | | 5584 | | 623 | | 838 | | 1101 | | 914 | | - | | - | |
| 1x1/2 | 479 | | 732 | | 624 | | 839 | | 1102 | | 915 | | - | | 32594 | |
| 1x3/4 | 478 | | 731 | | 625 | | 840 | | 1103 | | 916 | | 1153 | | 32595 | |
| 1 1/4x1/4 | - | | - | | - | | - | | 1104 | | 5592 | | - | | - | |
| 1 1/4x3/8 | - | | - | | 5574 | | 32564 | | 1105 | | 5593 | | - | | - | |
| 1 1/4x1/2 | 482 | | 735 | | 626 | | 841 | | 1106 | | 917 | | - | | - | |
| 1 1/4x3/4 | 481 | | 734 | | 627 | | 842 | | 1107 | | 918 | | - | | 32598 | |
| 1 1/4x1 | 480 | | 733 | | 628 | | 843 | | 1108 | | 919 | | 32415 | | 32597 | |
| 1 1/2x1/4 | - | | - | | - | | - | | 1109 | | 13773 | | - | | - | |
| 1 1/2x3/8 | - | | - | | - | | - | | 1110 | | 5594 | | - | | - | |
| 1 1/2x1/2 | 486 | | 32460 | | 629 | | 844 | | 1111 | | 920 | | - | | - | |
| 1 1/2x3/4 | 485 | | 738 | | 630 | | 845 | | 1112 | | 921 | | - | | - | |
| 1 1/2x1 | 484 | | 737 | | 631 | | 846 | | 1113 | | 922 | | - | | 32593 | |
| 1 1/2x1 1/4 | 483 | | 736 | | 632 | | 847 | | 1114 | | 923 | | 32419 | | 32599 | |
| 2x1/4 | - | | - | | - | | - | | 1115 | | 13775 | | 1115 | | - | |
| 2x3/8 | - | | - | | - | | - | | 5629 | | 13774 | | - | | - | |
| 2x1/2 | 18747 | | - | | 633 | | 848 | | 1116 | | 924 | | - | | - | |
| 2x3/4 | 490 | | 741 | | 634 | | 849 | | 1117 | | 5678 | | - | | - | |
| 2x1 | 489 | | 740 | | 635 | | 850 | | 1118 | | 925 | | - | | 32600 | |
| 2x1 1/4 | 488 | | 739 | | 636 | | 851 | | 1119 | | 926 | | - | | 32601 | |
| 2x1 1/2 | 487 | | 20322 | | 637 | | 852 | | 1120 | | 927 | | 32423 | | 32602 | |
| 2 1/2x1/2 | - | | - | | - | | - | | 1121 | | 13776 | | - | | - | |
| 2 1/2x3/4 | - | | - | | - | | 18013 | | 1122 | | 13777 | | - | | - | |
| 2 1/2x1 | - | | - | | 638 | | 853 | | 1123 | | 928 | | - | | - | |
| 2 1/2x1 1/4 | - | | - | | 639 | | 854 | | 1124 | | 5595 | | - | | - | |
| 2 1/2x1 1/2 | 22464 | | 12189 | | 640 | | 855 | | 1125 | | 929 | | - | | - | |
| 2 1/2x2 | 491 | | 742 | | 641 | | 856 | | 1126 | | 930 | | 32425 | | 32603 | |
| 3x1/2 | - | | - | | - | | - | | 18002 | | 13778 | | - | | - | |
| 3x3/4 | - | | - | | 32391 | | 32565 | | 1127 | | 13779 | | - | | - | |
| 3x1 | - | | - | | 642 | | 857 | | 1128 | | 5596 | | - | | - | |
| 3x1 1/4 | - | | - | | 643 | | 5588 | | 1129 | | 931 | | - | | - | |
| 3x1 1/2 | - | | - | | 644 | | 858 | | 1130 | | 932 | | - | | - | |
| 3x2 | 5533 | | 743 | | 645 | | 859 | | 1131 | | 933 | | 32426 | | 32604 | |
| 3x2 1/2 | 5532 | | 11872 | | 646 | | 860 | | 1132 | | 934 | | - | | 32605 | |
| 3 1/2x1 | - | | - | | - | | - | | 32400 | | 32582 | | - | | - | |
| 3 1/2x1 1/4 | - | | - | | - | | - | | 1133 | | 32583 | | - | | - | |
| 3 1/2x1 1/2 | - | | - | | - | | - | | 1134 | | 21294 | | - | | - | |
| 3 1/2x2 | - | | - | | 5575 | | - | | 1135 | | 19865 | | - | | - | |
| 3 1/2x2 1/2 | - | | - | | - | | - | | 1136 | | 32584 | | - | | - | |
| 3 1/2x3 | - | | - | | - | | 32566 | | 1137 | | 26495 | | - | | - | |

150 LB. REDUCING FITTINGS

| | 90° ELBOW | | | | COUPLING | | | | BUSHING | | | | FACE BUSHING | | | |
|---------|-----------|-------|-------|-------|----------|-------|-------|-------|---------|-------|-------|-------|--------------|-------|-------|-------|
| | BLACK | | GALV | | BLACK | | GALV | | BLACK | | GALV | | BLACK | | GALV | |
| | FIG | PRICE | FIG | PRICE | FIG | PRICE | FIG | PRICE | FIG | PRICE | FIG | PRICE | FIG | PRICE | FIG | PRICE |
| 4X1 | - | - | - | - | - | - | - | - | 1138 | - | 13780 | - | - | - | - | |
| 4X1 1/4 | - | - | - | - | - | - | - | - | 1139 | - | 13781 | - | - | - | - | |
| 4X1 1/2 | - | - | - | - | 647 | - | 11926 | - | 1140 | - | 13782 | - | - | - | - | |
| 4X2 | 5535 | - | 32461 | - | 648 | - | 11923 | - | 1141 | - | 935 | - | - | - | - | |
| 4X2 1/2 | 5534 | - | - | - | 649 | - | 11917 | - | 1142 | - | 936 | - | - | - | - | |
| 4X3 | 492 | - | 11876 | - | 650 | - | 861 | - | 1143 | - | 937 | - | 32431 | - | 32606 | |
| 4X3 1/2 | - | - | - | - | 32392 | - | 32567 | - | 1144 | - | 32586 | - | - | - | - | |
| 5X2 | - | - | - | - | - | - | - | - | 1145 | - | 26497 | - | - | - | - | |
| 5X2 1/2 | - | - | - | - | - | - | - | - | 32401 | - | 26498 | - | - | - | - | |
| 5X3 | - | - | - | - | - | - | - | - | 1146 | - | 26499 | - | - | - | - | |
| 5X4 | - | - | - | - | 23497 | - | 32568 | - | 1147 | - | 26500 | - | 32433 | - | 32607 | |
| 6X2 | - | - | - | - | - | - | - | - | 25511 | - | 26501 | - | - | - | - | |
| 6X2 1/2 | - | - | - | - | - | - | - | - | 32402 | - | 26502 | - | - | - | - | |
| 6X3 | - | - | - | - | - | - | - | - | 1148 | - | 23119 | - | - | - | - | |
| 6X4 | - | - | - | - | 22966 | - | 11930 | - | 1149 | - | 26504 | - | - | - | - | |
| 6X5 | - | - | 32462 | - | 23689 | - | - | - | 1150 | - | 26505 | - | 32434 | - | 32608 | |

150 LB. MALLEABLE IRON PIPE FITTINGS



REDUCING STREET TEE

| Size | Fig No | Price |
|---------|--------|-------|
| 3/4X1/2 | 23488 | |
| 1X3/4 | 23489 | |



ALL IRON UNION

1/4" - 2"
AVAILABLE!



SIDE OUTLET TEE



WASTENUT



SIDE OUTLET 90° ELBOW

ALL SIZES AVAILABLE!

150 LB. MALLEABLE IRON PIPE FITTINGS REDUCING TEE

| SIZE | | | BLACK | | GALV | |
|-------|-------|-------|-------|-------|-------|-------|
| A | B | C | FIG | PRICE | FIG | PRICE |
| 1/4 | 1/4 | 1/8 | 5543 | | 789 | |
| 1/8 | 1/8 | 1/4 | - | | - | |
| 3/8 | 3/8 | 1/4 | 5544 | | 5852 | |
| 3/8 | 1/4 | 3/8 | 32353 | | 32493 | |
| 3/8 | 1/4 | 1/4 | 32352 | | 32492 | |
| 1/4 | 1/4 | 3/8 | 32351 | | 32491 | |
| 1/2 | 1/2 | 3/8 | 5547 | | 790 | |
| 1/2 | 1/2 | 1/4 | 5548 | | 18029 | |
| 1/2 | 3/8 | 1/2 | 32355 | | 32498 | |
| 1/2 | 3/8 | 3/8 | 20583 | | 32497 | |
| 3/8 | 3/8 | 1/2 | 32354 | | 32495 | |
| 3/4 | 3/4 | 1/2 | 5551 | | 791 | |
| 3/4 | 3/4 | 3/8 | 5552 | | 23011 | |
| 3/4 | 3/4 | 1/4 | 19011 | | 32499 | |
| 3/4 | 1/2 | 3/4 | 5554 | | 792 | |
| 3/4 | 1/2 | 1/2 | 5553 | | 793 | |
| 3/4 | 3/8 | 3/4 | 20009 | | 32502 | |
| 3/4 | 3/8 | 3/8 | - | | - | |
| 3/4 | 1/4 | 3/4 | 32357 | | 32501 | |
| 1/2 | 1/2 | 3/4 | 5546 | | 20553 | |
| 1 | 1 | 3/4 | 557 | | 794 | |
| 1 | 1 | 1/2 | 556 | | 795 | |
| 1 | 1 | 3/8 | 19088 | | 23795 | |
| 1 | 1 | 1/4 | 20006 | | 22027 | |
| 1 | 3/4 | 1 | 555 | | 796 | |
| 1 | 3/4 | 3/4 | 554 | | 797 | |
| 1 | 3/4 | 1/2 | 553 | | 21855 | |
| 1 | 1/2 | 1 | 552 | | 798 | |
| 1 | 1/2 | 3/4 | 551 | | 18028 | |
| 1 | 1/2 | 1/2 | 550 | | 799 | |
| 1 | 1/4 | 1 | 24009 | | 18237 | |
| 3/4 | 3/4 | 1 | 5550 | | 18988 | |
| 1/2 | 1/2 | 1 | 32356 | | 32500 | |
| 1 1/4 | 1 1/4 | 1 | 566 | | 13797 | |
| 1 1/4 | 1 1/4 | 3/4 | 565 | | 13798 | |
| 1 1/4 | 1 1/4 | 1/2 | 564 | | 13799 | |
| 1 1/4 | 1 1/4 | 3/8 | 32361 | | 13800 | |
| 1 1/4 | 1 | 1 1/4 | 563 | | 13801 | |
| 1 1/4 | 1 | 1 | 562 | | 13802 | |
| 1 1/4 | 1 | 3/4 | 5559 | | 13803 | |
| 1 1/4 | 1 | 1/2 | 5558 | | 32506 | |
| 1 1/4 | 3/4 | 1 1/4 | 561 | | 18010 | |
| 1 1/4 | 3/4 | 1 | 560 | | 32505 | |
| 1 1/4 | 3/4 | 3/4 | 559 | | 32504 | |
| 1 1/4 | 1/2 | 1 1/4 | 558 | | 20866 | |
| 1 1/4 | 1/2 | 1 | 5555 | | 20644 | |
| 1 | 1 | 1 | 20582 | | 20502 | |
| 3/4 | 3/4 | 1 1/4 | 32358 | | 32503 | |
| 1 1/2 | 1 1/2 | 1 1/4 | 576 | | 18335 | |
| 1 1/2 | 1 1/2 | 1 | 575 | | 18336 | |
| 1 1/2 | 1 1/2 | 3/4 | 574 | | 18337 | |
| 1 1/2 | 1 1/2 | 1/2 | 573 | | 18338 | |
| 1 1/2 | 1 1/4 | 1 1/2 | 572 | | 800 | |
| 1 1/2 | 1 1/4 | 1 1/4 | 571 | | 801 | |
| 1 1/2 | 1 1/4 | 1 | 21142 | | 21372 | |
| 1 1/2 | 1 1/4 | 3/4 | 32364 | | 32512 | |
| 1 1/2 | 1 1/4 | 1/2 | 32363 | | 32511 | |
| 1 1/2 | 1 | 1 1/2 | 570 | | 32510 | |
| 1 1/2 | 1 | 1 1/4 | 5569 | | 32509 | |
| 1 1/2 | 1 | 1 | 569 | | 802 | |
| 1 1/2 | 3/4 | 1 1/2 | 568 | | 18192 | |
| 1 1/2 | 3/4 | 3/4 | 5566 | | 32508 | |
| 1 1/2 | 1/2 | 1 1/2 | 567 | | 32507 | |

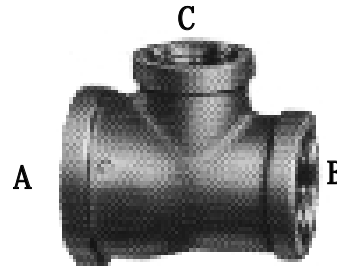

| SIZE | | | BLACK | | GALV | |
|-------|-------|-------|-------|-------|-------|-------|
| A | B | C | FIG | PRICE | FIG | PRICE |
| 1 1/4 | 1 1/4 | 1 1/2 | 32362 | | 20586 | |
| 1 | 1 | | 32360 | | 30163 | |
| 2 | 2 | 1 1/2 | 587 | | 803 | |
| 2 | 2 | 1 1/4 | 586 | | 804 | |
| 2 | 2 | 1 | 585 | | 805 | |
| 2 | 2 | 3/4 | 584 | | 806 | |
| 2 | 2 | 1/2 | 583 | | 807 | |
| 2 | 1 1/2 | 2 | 582 | | 5585 | |
| 2 | 1 1/2 | 1 1/2 | 581 | | 808 | |
| 2 | 1 1/2 | 1 1/4 | 32369 | | 32524 | |
| 2 | 1 1/2 | 1 | 32368 | | 32523 | |
| 2 | 1 1/4 | 2 | 580 | | 809 | |
| 2 | 1 1/4 | 1 1/2 | 23548 | | 5586 | |
| 2 | 1 1/4 | 1 1/4 | 22428 | | 30665 | |
| 2 | 1 | 2 | 579 | | 810 | |
| 2 | 3/4 | 2 | 578 | | 32518 | |
| 2 | 1/2 | 2 | 577 | | 32517 | |
| 1 1/2 | 1 1/2 | 2 | 32365 | | 23635 | |
| 1 1/4 | 1 1/4 | 2 | 39329 | | 40036 | |
| 2 1/2 | 2 1/2 | 2 | 591 | | 811 | |
| 2 1/2 | 2 1/2 | 1 1/2 | 590 | | 32532 | |
| 2 1/2 | 2 1/2 | 1 1/4 | 589 | | 32531 | |
| 2 1/2 | 2 1/2 | 1 | 588 | | 32530 | |
| 2 1/2 | 2 1/2 | 3/4 | 20008 | | 32529 | |
| 2 1/2 | 2 | 2 1/2 | 24271 | | 18745 | |
| 2 1/2 | 2 | 2 | 32372 | | 30137 | |
| 2 1/2 | 1 1/2 | 2 1/2 | 20007 | | 32528 | |
| 2 1/2 | 1 1/2 | 2 | 25275 | | 32527 | |
| 2 | 2 | 2 1/2 | 24271 | | 32525 | |
| 3 | 3 | 2 1/2 | 598 | | 812 | |
| 3 | 3 | 2 | 597 | | 813 | |
| 3 | 3 | 1 1/2 | 596 | | 814 | |
| 3 | 3 | 1 1/4 | 595 | | 23797 | |
| 3 | 3 | 1 | 594 | | 21728 | |
| 3 | 3 | 3/4 | 32379 | | 32537 | |
| 3 | 2 1/2 | 2 1/2 | 32378 | | 30136 | |
| 3 | 2 1/2 | 2 | 32377 | | 32536 | |
| 3 | 2 | 3 | 593 | | 29756 | |
| 3 | 2 | 2 | 592 | | 21591 | |
| 2 1/2 | 2 1/2 | 3 | 32374 | | 32533 | |
| 4 | 4 | 3 | 602 | | 815 | |
| 4 | 4 | 2 1/2 | 601 | | 19444 | |
| 4 | 4 | 2 | 600 | | 32547 | |
| 4 | 4 | 1 1/2 | 599 | | 32546 | |
| 4 | 3 | 4 | 32384 | | 32542 | |
| 3 | 3 | 4 | 32380 | | 32538 | |
| 6 | 6 | 4 | 21928 | | 32553 | |
| 6 | 6 | 3 | 21929 | | 32552 | |
| 6 | 6 | 2 1/2 | 32389 | | 32550 | |
| 6 | 6 | 2 | 32388 | | 32549 | |

150 LB. MALLEABLE IRON PIPE FITTINGS



Coupling



Cap



Plug



Countersunk Plug

| SIZE | BLACK | | GALV | | BLACK | | GALV | | BLACK | | GALV | | BLACK | | GALV | |
|-------|--------|-------|--------|-------|--------|-------|--------|-------|--------|-------|--------|-------|--------|-------|--------|-------|
| | FIG NO | PRICE | FIG NO | PRICE | FIG NO | PRICE | FIG NO | PRICE | FIG NO | PRICE | FIG NO | PRICE | FIG NO | PRICE | FIG NO | PRICE |
| 1/8 | 39936 | | 43116 | | 674 | | 862 | | 1154 | | 880 | | 23503 | | - | |
| 1/4 | 39912 | | 43117 | | 675 | | 863 | | 1155 | | 881 | | 1168 | | 32612 | |
| 3/8 | 39913 | | 43118 | | 676 | | 864 | | 1156 | | 882 | | 1169 | | 32613 | |
| 1/2 | 39914 | | 43119 | | 677 | | 865 | | 1157 | | 883 | | 1170 | | 32614 | |
| 3/4 | 39915 | | 43120 | | 678 | | 866 | | 1158 | | 884 | | 1171 | | 32615 | |
| 1 | 39916 | | 43121 | | 679 | | 867 | | 1159 | | 885 | | 1172 | | 32616 | |
| 1 1/4 | 39917 | | 43122 | | 680 | | 868 | | 1160 | | 886 | | 1173 | | 32617 | |
| 1 1/2 | 39918 | | 43123 | | 681 | | 869 | | 1161 | | 887 | | 1174 | | 32618 | |
| 2 | 39919 | | 43124 | | 682 | | 870 | | 1162 | | 888 | | 1175 | | 32619 | |
| 2 1/2 | 39920 | | 43125 | | 683 | | 871 | | 1163 | | 889 | | 5856 | | 32620 | |
| 3 | 39921 | | 43126 | | 684 | | 872 | | 1164 | | 890 | | 1176 | | 32621 | |
| 3 1/2 | 43110 | | 43127 | | 32394 | | 32569 | | 1165 | | 32609 | | 5630 | | 32622 | |
| 4 | 39922 | | 43128 | | 685 | | 873 | | 1166 | | 891 | | 5631 | | 32623 | |
| 5 | 4311 | | 43129 | | 5581 | | 32570 | | 5854 | | 32610 | | - | | - | |
| 6 | 43112 | | 43130 | | 686 | | 11951 | | 1167 | | 32611 | | - | | - | |
| 8 | - | | - | | - | | 32571 | | - | | - | | - | | - | |

STEEL COUPLING MAY BE SHIPPED UNLESS YOU SPECIFICALLY REQUEST MALLEABLE.



Union



Floor Flange



Half Coupling



Extension Piece



Hex Locknut

| SIZE | BLACK | | GALV | | BLACK | | GALV | | BLACK | | GALV | | BLACK | | GALV | | | |
|-------|--------|-------|--------|-------|--------|-------|--------|-------|--------|-------|--------|-------|--------|-------|--------|-------|-------|-------|
| | FIG NO | PRICE | FIG NO | PRICE | FIG NO | PRICE | FIG NO | PRICE | FIG NO | PRICE | FIG NO | PRICE | FIG NO | PRICE | FIG NO | PRICE | | |
| 1/8 | 660 | | 892 | | - | | - | | 13784 | | - | | - | | 11837 | | 11960 | |
| 1/4 | 661 | | 893 | | 11608 | | 11953 | | 13785 | | - | | - | | 11840 | | 11962 | |
| 3/8 | 662 | | 894 | | 11610 | | 11957 | | 13786 | | - | | 11606 | | 13812 | | 11844 | 11966 |
| 1/2 | 663 | | 895 | | 654 | | 874 | | 13787 | | - | | 11519 | | 11988 | | 11846 | 11969 |
| 3/4 | 664 | | 896 | | 655 | | 875 | | 13788 | | - | | 11521 | | 11993 | | 11850 | 11973 |
| 1 | 665 | | 897 | | 656 | | 876 | | 13789 | | - | | 11523 | | 11996 | | 11851 | 11975 |
| 1 1/4 | 666 | | 898 | | 657 | | 877 | | 13790 | | - | | 11525 | | 11999 | | 11857 | 11979 |
| 1 1/2 | 667 | | 899 | | 658 | | 878 | | 13791 | | - | | 11526 | | 12001 | | 11861 | 11983 |
| 2 | 668 | | 900 | | 659 | | 879 | | 13792 | | - | | 11527 | | 12009 | | 11863 | 11986 |
| 2 1/2 | 669 | | 901 | | - | | - | | 13793 | | - | | - | | - | | - | 32577 |
| 3 | 670 | | 902 | | - | | - | | 13794 | | - | | - | | - | | - | - |
| 3 1/2 | - | | - | | - | | - | | 52222 | | - | | - | | - | | - | - |
| 4 | 5577 | | 5589 | | - | | - | | 13795 | | - | | - | | - | | - | - |

For additional information call: 610-275-4453 or Fax: 610-279-6299
Please call for current prices.

300 LB (XH) BLACK MALLEABLE PIPE FITTINGS



90° Elbow



90° Street Elbow



45° Elbow



45° Street Elbow



Tee

| SIZE | FIG NO | PRICE | FIG NO | PRICE | FIG NO | PRICE | FIG NO | PRICE | FIG NO | PRICE |
|-------|--------|-------|--------|-------|--------|-------|--------|-------|--------|-------|
| 1/4 | 11684 | | 11650 | | 11692 | | 11620 | | 11702 | |
| 3/8 | 11686 | | 11653 | | 11694 | | 11624 | | 11704 | |
| 1/2 | 687 | | 11655 | | 693 | | 11625 | | 699 | |
| 3/4 | 688 | | 11657 | | 694 | | 11627 | | 700 | |
| 1 | 689 | | 11659 | | 695 | | 11628 | | 701 | |
| 1 1/4 | 690 | | 11661 | | 696 | | 11637 | | 702 | |
| 1 1/2 | 691 | | 11663 | | 697 | | 11639 | | 703 | |
| 2 | 692 | | 11665 | | 698 | | 11642 | | 704 | |
| 2 1/2 | 18103 | | 11666 | | 11696 | | 11644 | | 705 | |
| 3 | 11689 | | 11668 | | 11697 | | 11646 | | 706 | |
| 4 | 11691 | | - | | 11699 | | 11649 | | 707 | |
| 6 | 32633 | | - | | - | | - | | - | |



Cross



Coupling



Half Coupling



Cap



Union

| SIZE | FIG NO | PRICE | FIG NO | PRICE | FIG NO | PRICE | FIG NO | PRICE | FIG NO | PRICE |
|-------|--------|-------|--------|-------|--------|-------|--------|-------|--------|-------|
| 1/8 | - | | 39923 | | 43135 | | 36417 | | 11611 | |
| 1/4 | 32677 | | 39924 | | 43136 | | 11803 | | 11613 | |
| 3/8 | 32678 | | 39925 | | 43137 | | 11807 | | 11615 | |
| 1/2 | 18319 | | 39926 | | 43138 | | 11811 | | 11672 | |
| 3/4 | 18320 | | 39927 | | 43139 | | 11813 | | 11673 | |
| 1 | 18321 | | 39928 | | 43140 | | 11817 | | 11675 | |
| 1 1/4 | 18322 | | 39929 | | 43141 | | 11820 | | 11677 | |
| 1 1/2 | 18323 | | 39930 | | 43142 | | 11821 | | 11678 | |
| 2 | 18324 | | 39931 | | 43143 | | 11824 | | 11680 | |
| 2 1/2 | 32679 | | 39932 | | 43144 | | 11828 | | 18102 | |
| 3 | 32680 | | 39933 | | 43145 | | 11835 | | 11681 | |

**300 LB. (XH) BLACK MALLEABLE PIPE FITTINGS
(GALVANIZED AVAILABLE)**



| SIZE | REDUCING TEE | | REDUCING 90° ELBOW | | REDUCING COUPLING | |
|-------------|--------------|-------|--------------------|-------|-------------------|-------|
| | FIG. NO. | PRICE | FIG. NO. | PRICE | FIG. NO. | PRICE |
| 3/8X1/4 | 11735 | | 32634 | | 11761 | |
| 1/2X1/4 | 32647 | | - | | 32681 | |
| 1/2X3/8 | 11738 | | 32635 | | 11766 | |
| 3/4X1/4 | 32651 | | - | | 32682 | |
| 3/4X3/8 | 32652 | | - | | 32683 | |
| 3/4X1/2 | 11741 | | 32636 | | 11770 | |
| 1X1/4 | 32657 | | - | | - | |
| 1X3/8 | 32658 | | - | | 32684 | |
| 1X1/2 | 32659 | | 32637 | | 31396 | |
| 1X3/4 | 11742 | | 32638 | | 11774 | |
| 1 1/4X1/2 | 32662 | | - | | 32685 | |
| 1 1/4X3/4 | 32663 | | 32639 | | 32686 | |
| 1 1/4X1 | 11745 | | 32640 | | 11779 | |
| 1 1/2X1/2 | 32665 | | - | | 32687 | |
| 1 1/2X3/4 | 32666 | | - | | 19422 | |
| 1 1/2X1 | 32667 | | 32641 | | 19421 | |
| 1 1/2X1 1/4 | 11747 | | 32642 | | 11782 | |
| 2 X 1/2 | 32669 | | - | | 32688 | |
| 2X3/4 | 32670 | | - | | - | |
| 2X1 | 32671 | | - | | 32689 | |
| 2X1 1/4 | 32672 | | - | | 18235 | |
| 2X1 1/2 | 11750 | | 32643 | | 11785 | |
| 2 1/2X1 1/2 | 32673 | | - | | - | |
| 2 1/2X2 | 11751 | | 32644 | | 11792 | |
| 3X1 1/2 | 40007 | | - | | - | |
| 3X2 | 32675 | | - | | 32690 | |
| 3X2 1/2 | 11753 | | - | | 11795 | |
| 4X2 1/2 | 32676 | | - | | - | |
| 4X3 | 11757 | | - | | 11799 | |



**Male X Female Union
AVAILABLE FOR QUICK
DELIVERY!**



**FEMALE UNION
EXTRA HEAVY
90° ELBOW**



**MALE UNION
EXTRA HEAVY
90° ELBOW**

| Size | Fig No | Price |
|-------|--------|-------|
| 1/2 | 23490 | |
| 3/4 | 22023 | |
| 1 | 23491 | |
| 1 1/4 | 23492 | |
| 1 1/2 | 23493 | |
| 2 | 23494 | |

| Size | Fig No | Price |
|-------|--------|-------|
| 1/2 | 32442 | |
| 3/4 | 32443 | |
| 1 | 32444 | |
| 1 1/4 | 32445 | |
| 1 1/2 | 32446 | |
| 2 | 32447 | |

STANDARD BLACK STEEL NIPPLES

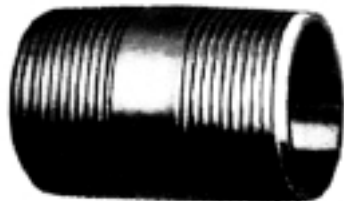

| | 1/8 | | 1/4 | | 3/8 | | 1/2 | | 3/4 | | 1 | | 1 1/4 | | 1 1/2 | |
|-------|--------|-------|--------|-------|--------|-------|--------|-------|--------|-------|--------|-------|--------|-------|--------|-------|
| SIZE | FIG NO | PRICE | FIG NO | PRICE | FIG NO | PRICE | FIG NO | PRICE | FIG NO | PRICE | FIG NO | PRICE | FIG NO | PRICE | FIG NO | PRICE |
| Close | 198 | | 210 | | 222 | | 234 | | 252 | | 270 | | 287 | | 304 | |
| Sh. | 199 | | 211 | | 223 | | 235 | | 253 | | 271 | | 288 | | 305 | |
| 2 | 200 | | 212 | | 224 | | 236 | | 254 | | - | | - | | - | |
| 2 1/2 | 201 | | 213 | | 225 | | 237 | | 255 | | 272 | | 289 | | 306 | |
| 3 | 202 | | 214 | | 226 | | 238 | | 256 | | 273 | | 290 | | 307 | |
| 3 1/2 | 203 | | 215 | | 227 | | 239 | | 257 | | 274 | | 291 | | 308 | |
| 4 | 204 | | 216 | | 228 | | 240 | | 258 | | 275 | | 292 | | 309 | |
| 4 1/2 | 205 | | 217 | | 229 | | 241 | | 259 | | 276 | | 293 | | 310 | |
| 5 | 206 | | 218 | | 230 | | 242 | | 260 | | 277 | | 294 | | 311 | |
| 5 1/2 | 207 | | 219 | | 231 | | 243 | | 261 | | 278 | | 295 | | 312 | |
| 6 | 208 | | 220 | | 232 | | 244 | | 262 | | 279 | | 296 | | 313 | |
| 7 | 26257 | | 26273 | | 26294 | | 246 | | 264 | | 281 | | 298 | | 315 | |
| 8 | 26260 | | 26275 | | 26296 | | 247 | | 265 | | 282 | | 299 | | 316 | |
| 9 | 26262 | | 26278 | | 26298 | | 248 | | 266 | | 283 | | 300 | | 317 | |
| 10 | 26264 | | 25554 | | 26300 | | 249 | | 267 | | 284 | | 301 | | 318 | |
| 11 | 26266 | | 26285 | | 26302 | | 250 | | 268 | | 285 | | 302 | | 319 | |
| 12 | 26267 | | 26289 | | 26304 | | 251 | | 269 | | 286 | | 303 | | 320 | |

| | 2 | | 2 1/2 | | 3 | | 3 1/2 | | 4 | | 5 | | 6 | |
|-------|--------|-------|--------|-------|--------|-------|--------|-------|--------|-------|--------|-------|--------|-------|
| SIZE | FIG NO | PRICE | FIG NO | PRICE | FIG NO | PRICE | FIG NO | PRICE | FIG NO | PRICE | FIG NO | PRICE | FIG NO | PRICE |
| Close | 321 | | 337 | | 352 | | 5473 | | 367 | | 5505 | | 5517 | |
| Sh. | 322 | | 19522 | | 353 | | 5474 | | 368 | | 5506 | | 5518 | |
| 2 | - | | - | | - | | - | | - | | - | | - | |
| 2 1/2 | - | | - | | - | | - | | - | | - | | - | |
| 3 | 323 | | - | | - | | - | | - | | - | | - | |
| 3 1/2 | 324 | | 339 | | 354 | | - | | - | | - | | - | |
| 4 | 325 | | 340 | | 355 | | - | | - | | - | | - | |
| 4 1/2 | 326 | | 341 | | 356 | | 5475 | | 369 | | 5507 | | 5519 | |
| 5 | 327 | | 342 | | 357 | | 5476 | | 370 | | 5508 | | 5520 | |
| 5 1/2 | 328 | | 343 | | 358 | | 5477 | | 371 | | 5509 | | 5521 | |
| 6 | 329 | | 344 | | 359 | | 5478 | | 372 | | 5510 | | 5522 | |
| 7 | 331 | | 346 | | 361 | | 5480 | | 374 | | 5511 | | 5523 | |
| 8 | 332 | | 347 | | 362 | | 5482 | | 375 | | 5512 | | 5524 | |
| 9 | 333 | | 348 | | 363 | | 5484 | | 376 | | 5513 | | 5525 | |
| 10 | 334 | | 349 | | 364 | | 5486 | | 377 | | 5514 | | 5526 | |
| 11 | 335 | | 350 | | 365 | | 5488 | | 378 | | 5515 | | 5527 | |
| 12 | 336 | | 351 | | 366 | | 5490 | | 379 | | 5516 | | 5528 | |

CALL DUFF FOR ALL YOUR NIPPLES:

Black, Galvanized, Brass, Seamless, Chrome, PVC, CPVC, Monel, Standard, Extra Heavy, Double Extra Heavy.

STANDARD GALVANIZED STEEL NIPPLES

| SIZE | 1/8 | | 1/4 | | 3/8 | | 1/2 | | 3/4 | | 1 | |
|-------|--------|-------|--------|-------|--------|-------|--------|-------|--------|-------|--------|-------|
| | FIG NO | PRICE | FIG NO | PRICE | FIG NO | PRICE | FIG NO | PRICE | FIG NO | PRICE | FIG NO | PRICE |
| Close | 20 | | 32 | | 44 | | 56 | | 69 | | 87 | |
| Sh. | 21 | | 33 | | 45 | | 57 | | 70 | | 88 | |
| 2 | 22 | | 34 | | 46 | | 58 | | 71 | | - | |
| 2 1/2 | 23 | | 35 | | 47 | | 59 | | 72 | | 89 | |
| 3 | 24 | | 36 | | 48 | | 60 | | 73 | | 90 | |
| 3 1/2 | 25 | | 37 | | 49 | | 61 | | 74 | | 91 | |
| 4 | 26 | | 38 | | 50 | | 62 | | 75 | | 92 | |
| 4 1/2 | 27 | | 39 | | 51 | | 63 | | 76 | | 93 | |
| 5 | 28 | | 40 | | 52 | | 64 | | 77 | | 94 | |
| 5 1/2 | 29 | | 41 | | 53 | | 65 | | 78 | | 95 | |
| 6 | 30 | | 42 | | 54 | | 66 | | 79 | | 96 | |
| 7 | - | | - | | - | | 12953 | | 81 | | 98 | |
| 8 | - | | - | | - | | 12957 | | 82 | | 99 | |
| 9 | - | | - | | - | | 5350 | | 83 | | - | |
| 10 | - | | - | | - | | 5352 | | 84 | | 101 | |
| 11 | - | | - | | - | | 5354 | | 85 | | 102 | |
| 12 | - | | - | | - | | 68 | | 86 | | 103 | |

| SIZE | 1 1/4 | | 1 1/2 | | 2 | | 2 1/2 | | 3 | | 4 | |
|-------|--------|-------|--------|-------|--------|-------|--------|-------|--------|-------|--------|-------|
| | FIG NO | PRICE | FIG NO | PRICE | FIG NO | PRICE | FIG NO | PRICE | FIG NO | PRICE | FIG NO | PRICE |
| Close | 104 | | 125 | | 146 | | 166 | | 175 | | 186 | |
| Sh. | 105 | | 126 | | 147 | | 167 | | 176 | | 187 | |
| 2 | - | | - | | - | | - | | - | | - | |
| 2 1/2 | 106 | | 127 | | - | | - | | - | | - | |
| 3 | 107 | | 128 | | 148 | | - | | - | | - | |
| 3 1/2 | 108 | | 129 | | 149 | | 168 | | 177 | | - | |
| 4 | 109 | | 130 | | 150 | | 169 | | 178 | | - | |
| 4 1/2 | 110 | | 131 | | 151 | | 170 | | 179 | | 188 | |
| 5 | 111 | | 132 | | 152 | | 171 | | 180 | | 189 | |
| 5 1/2 | 112 | | 133 | | 153 | | 172 | | 181 | | 190 | |
| 6 | 113 | | 134 | | 154 | | 173 | | 182 | | 191 | |
| 7 | 115 | | 136 | | 156 | | 5384 | | 5395 | | 192 | |
| 8 | 116 | | 137 | | 157 | | 5386 | | 5396 | | 193 | |
| 9 | 117 | | 138 | | 158 | | 5388 | | 5397 | | 194 | |
| 10 | 118 | | 139 | | 159 | | 5390 | | 5398 | | 195 | |
| 11 | 119 | | 140 | | 160 | | 5392 | | 184 | | 196 | |
| 12 | 120 | | 141 | | 161 | | 5394 | | 185 | | 197 | |

EXTRA HEAVY BLACK STEEL NIPPLES

| SIZE | 1/8 | | 1/4 | | 3/8 | | 1/2 | | 3/4 | | 1 | |
|-------|--------|-------|--------|-------|--------|-------|--------|-------|--------|-------|--------|-------|
| | FIG NO | PRICE | FIG NO | PRICE | FIG NO | PRICE | FIG NO | PRICE | FIG NO | PRICE | FIG NO | PRICE |
| Close | 18171 | | 18384 | | 380 | | 391 | | 403 | | 415 | |
| Sh. | 18374 | | 18385 | | 381 | | 392 | | 404 | | 416 | |
| 2 | 18375 | | 18386 | | 382 | | 393 | | 405 | | - | |
| 2 1/2 | 18376 | | 18387 | | 383 | | 394 | | 406 | | 417 | |
| 3 | 18377 | | 18388 | | 384 | | 395 | | 407 | | 418 | |
| 3 1/2 | 18378 | | 18389 | | 385 | | 396 | | 51611 | | 419 | |
| 4 | 18379 | | 18390 | | 386 | | 397 | | 409 | | 420 | |
| 4 1/2 | 18380 | | 18391 | | 387 | | 398 | | 410 | | 421 | |
| 5 | 18381 | | 18392 | | 388 | | 399 | | 411 | | 422 | |
| 5 1/2 | 18382 | | 18393 | | 389 | | 400 | | 412 | | 423 | |
| 6 | 18383 | | 18394 | | 390 | | 401 | | 413 | | 424 | |

| SIZE | 1 1/4 | | 1 1/2 | | 2 | | 2 1/2 | | 3 | | 4 | |
|-------|--------|-------|--------|-------|--------|-------|--------|-------|--------|-------|--------|-------|
| | FIG NO | PRICE | FIG NO | PRICE | FIG NO | PRICE | FIG NO | PRICE | FIG NO | PRICE | FIG NO | PRICE |
| Close | 426 | | 437 | | 448 | | 17863 | | 17871 | | 17880 | |
| Sh. | 427 | | 438 | | 449 | | 17864 | | 17872 | | 17881 | |
| 2 | - | | - | | - | | - | | - | | - | |
| 2 1/2 | 428 | | 439 | | - | | - | | - | | - | |
| 3 | 429 | | 440 | | 450 | | - | | - | | - | |
| 3 1/2 | 430 | | 441 | | 451 | | 17865 | | 17873 | | - | |
| 4 | 431 | | 442 | | 452 | | 17866 | | 17874 | | - | |
| 4 1/2 | 432 | | 443 | | 453 | | 17867 | | 17875 | | 17882 | |
| 5 | 433 | | 444 | | 454 | | 17868 | | 17876 | | 17883 | |
| 5 1/2 | 434 | | 445 | | 455 | | 17869 | | 17877 | | 17884 | |
| 6 | 435 | | 446 | | 456 | | 17870 | | 17878 | | 17885 | |

" REAL PIPING SPECIFICATIONS"

All pipe is to be made of a long hole, surrounded by metal centered around the hole.

All pipe is to be hollow, throughout the entire length.



All pipe is to be supplied with nothing in the hole so that water, steam or other stuff can be put inside at a later date.

The OD of all pipe must exceed the ID, otherwise, the hole will be on the outside of the pipe.

All pipe over 500 feet in length must have the words "LONG PIPE" clearly painted on each end so that the fitter will know that it is long pipe.

All pipe over over six inches in diameter is to have the words "Large Pipe" painted on it, so that the fitter will not use it for small pipe.

No fittings are to be put on pipe unless specified. Otherwise, straight pipe becomes crooked pipe.

LONG NIPPLES

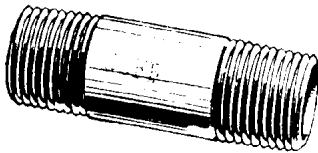

| BLACK | | | GALVANIZED | | BLACK | | | GALVANIZED | |
|----------|----------|-------|------------|-------|----------|----------|-------|------------|-------|
| SIZE | FIG. NO. | PRICE | FIG. NO. | PRICE | SIZE | FIG. NO. | PRICE | FIG. NO. | PRICE |
| 1/2 x 18 | 20054 | | 13180 | | 1 1/2x18 | 20058 | | 142 | |
| 1/2 x 24 | 13248 | | 13183 | | 1 1/2x24 | 5440 | | 143 | |
| 1/2 x 36 | 13250 | | 13772 | | 1 1/2x36 | 5441 | | 144 | |
| 1/2 x 48 | 13251 | | 13191 | | 1 1/2x48 | 5442 | | 145 | |
| 1/2 x 60 | 13252 | | 13192 | | 1 1/2x60 | 13270 | | 13225 | |
| 1/2 x 72 | 13253 | | 13193 | | 1 1/2x72 | 13271 | | 13227 | |
| 3/4 x 18 | 20055 | | 13196 | | 2x18 | 20059 | | 162 | |
| 3/4 x 24 | 13254 | | 13198 | | 2 x 24 | 5450 | | 163 | |
| 3/4 x 36 | 13255 | | 13200 | | 2 x 36 | 5451 | | 164 | |
| 3/4 x 48 | 13256 | | 13202 | | 2 x 48 | 5452 | | 165 | |
| 3/4 x 60 | 13258 | | 13204 | | 2 x 60 | 13230 | | 13295 | |
| 3/4 x 72 | 13259 | | 13205 | | 2 x 72 | 13234 | | 13296 | |
| 1 x 18 | 20056 | | 13207 | | 3 x 18 | 20061 | | - | |
| 1 x 24 | 13260 | | 13209 | | 3 x 24 | 5470 | | 13235 | |
| 1 x 36 | 13261 | | 13211 | | 3 x 36 | 5471 | | 13236 | |
| 1 x 48 | 13262 | | 13213 | | 3 x 48 | 5472 | | 13238 | |
| 1 x 60 | 13263 | | 13214 | | 3 x 60 | 13264 | | 13239 | |
| 1 x 72 | 13265 | | 13215 | | 3 x 72 | 13267 | | 13240 | |
| 1 1/4x18 | 20057 | | 121 | | 4 x 18 | 20062 | | - | |
| 1 1/4x24 | 5428 | | 122 | | 4 x 24 | 5502 | | 13241 | |
| 1 1/4x36 | 5429 | | 42877 | | 4 x 36 | 5503 | | 13242 | |
| 1 1/4x48 | 5430 | | 124 | | 4 x 48 | 5504 | | 13244 | |
| 1 1/4x60 | 13266 | | 13219 | | 4 x 60 | 13269 | | 13245 | |
| 1 1/4x72 | 13268 | | 13223 | | 4 x 72 | 13272 | | 13246 | |

Call Duff for all pipe fabrication - We can cut, thread, bend, bevel, groove or weld. Manifolds and spool pieces a specialty!

66-NIPPLE PAK

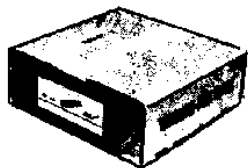

Six of each size nipple -- close trough 6", all in an easy to carry tray for truck or shop.

| Size | BLACK | | GALVANIZED | |
|------|--------|-------|------------|-------|
| | Fig No | Price | Fig No | Price |
| 1/2 | 13282 | | 13286 | |
| 3/4 | 13283 | | 13287 | |

COMBO NIPPLE BOX

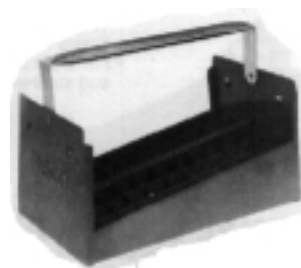

Holds both 1/2" and 3/4" nipples.

Great for the job site!

| Fig No | Price |
|--------|-------|
| 51243 | |

NIPPLE RUNS

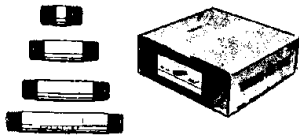

ONE OF EACH SIZE FROM CLOSE TO 6"

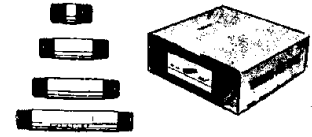

| SIZE | BLACK | | GALVANIZED | | EXTRA HEAVY BLACK | | BRASS | |
|-------|--------|-------|------------|-------|-------------------|-------|--------|-------|
| | FIG NO | PRICE | FIG NO | PRICE | FIG NO | PRICE | FIG NO | PRICE |
| 1/8 | 50989 | | 50977 | | 51004 | | 44496 | |
| 1/4 | 50990 | | 50978 | | 51005 | | 44497 | |
| 3/8 | 50991 | | 50979 | | 51006 | | 44498 | |
| 1/2 | 50992 | | 50980 | | 51007 | | 44499 | |
| 3/4 | 50993 | | 50981 | | 51008 | | 44500 | |
| 1 | 50994 | | 50982 | | 51009 | | 44501 | |
| 1 1/4 | 50995 | | 50983 | | 51010 | | 44502 | |
| 1 1/2 | 50996 | | 50984 | | 51011 | | 44503 | |
| 2 | 50997 | | 50985 | | 51013 | | 44504 | |
| 2 1/2 | 50998 | | 50986 | | 51014 | | 44505 | |
| 3 | 50999 | | 50987 | | 51015 | | 44506 | |
| 3 1/2 | 51000 | | - | | - | | - | |
| 4 | 51001 | | 50988 | | 51016 | | - | |
| 5 | 51002 | | - | | - | | - | |
| 6 | 51003 | | - | | - | | - | |

| SIZE | PVC SCH. 80 | | CPVC SCH. 80 | | CHROME PLATED BRASS | | 304 STAINLESS STEEL | | 316 STAINLESS STEEL | |
|-------|-------------|-------|--------------|-------|---------------------|-------|---------------------|-------|---------------------|-------|
| | FIG NO | PRICE | FIG NO | PRICE | FIG NO | PRICE | FIG NO | PRICE | FIG NO | PRICE |
| 1/8 | - | | - | | - | | 44507 | | 36405 | |
| 1/4 | - | | 51030 | | - | | 44508 | | 36406 | |
| 3/8 | 51018 | | 51031 | | 12638 | | 44509 | | 36407 | |
| 1/2 | 51019 | | 51032 | | 12640 | | 44510 | | 36408 | |
| 3/4 | 51020 | | 51033 | | 12641 | | 44511 | | 36409 | |
| 1 | 51021 | | 51034 | | - | | 44512 | | 36410 | |
| 1 1/4 | 51022 | | 51035 | | - | | 44513 | | 36411 | |
| 1 1/2 | 51023 | | 51036 | | - | | 44514 | | 36412 | |
| 2 | 51024 | | 51037 | | - | | 44515 | | 36413 | |
| 2 1/2 | 51025 | | - | | - | | - | | - | |
| 3 | 51026 | | - | | - | | - | | - | |
| 4 | 51027 | | - | | - | | - | | - | |
| 5 | - | | - | | - | | - | | - | |
| 6 | - | | - | | - | | - | | - | |

125 LB. CAST IRON SCREWED FITTINGS



| Size | 90° Elbow | | 45° Elbow | | Tee | |
|-------|-----------|-------|-----------|-------|----------|-------|
| | FIG. NO. | PRICE | FIG. NO. | PRICE | FIG. NO. | PRICE |
| 1/4 | 32631 | | 32699 | | 32704 | |
| 3/8 | 32632 | | 32700 | | 32705 | |
| 1/2 | 938 | | 974 | | 984 | |
| 3/4 | 939 | | 975 | | 985 | |
| 1 | 940 | | 976 | | 986 | |
| 1 1/4 | 941 | | 977 | | 987 | |
| 1 1/2 | 942 | | 978 | | 988 | |
| 2 | 943 | | 979 | | 989 | |
| 2 1/2 | 944 | | 980 | | 990 | |
| 3 | 945 | | 981 | | 991 | |
| 4 | 946 | | 982 | | 992 | |

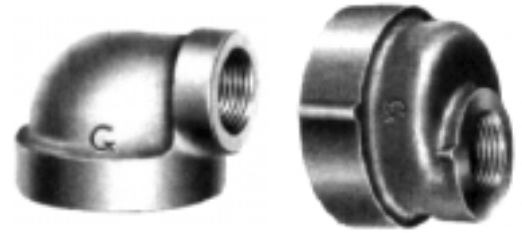

| Size | Reducing 90° Elbow | | Eccentric Reducer | |
|-------------|--------------------|-------|-------------------|-------|
| | Fig. No. | Price | Fig. No. | Price |
| 1/2x3/8 | 32697 | | - | |
| 3/4x1/2 | 948 | | - | |
| 1x1/2 | 949 | | - | |
| 1x3/4 | 950 | | 1080 | |
| 1 1/4x1/2 | 951 | | - | |
| 1 1/4X3/4 | 952 | | 1081 | |
| 1 1/4X1 | 953 | | 1082 | |
| 1 1/2X1/2 | 954 | | - | |
| 1 1/2X3/4 | 955 | | 1083 | |
| 1 1/2X1 | 956 | | 1084 | |
| 1 1/2X1 1/4 | 957 | | 1085 | |
| 2X1/2 | 958 | | - | |
| 2X3/4 | 959 | | 32765 | |
| 2X1 | 960 | | 1086 | |
| 2X1 1/4 | 961 | | 1087 | |
| 2X1/12 | 962 | | 1088 | |
| 2 1/2X1 | 963 | | - | |
| 2 1/2X11/4 | 964 | | 32766 | |
| 2 1/2X1 1/2 | 965 | | 32767 | |
| 2 1/2X2 | 966 | | 32768 | |
| 3X1 1/4 | 967 | | - | |
| 3X1 1/2 | 968 | | 32769 | |
| 3X2 | 969 | | 32770 | |
| 3X2 1/2 | 970 | | 32771 | |
| 4X2 | 971 | | 32772 | |
| 4X2 1/2 | 972 | | - | |
| 4X3 | 973 | | 32773 | |

BRASS SADDLE TEE



| SIZE | FIG. | PRICE |
|-----------|-------|-------|
| 1/2 1/2 | 47202 | |
| 3/4 1/2 | 47203 | |
| 3/4 3/4 | 52524 | |
| 1 1/2 | 48743 | |
| 1 3/4 | 52525 | |
| 1 1/4 1/2 | 26515 | |
| 1 1/4 3/4 | 26517 | |
| 1 1/4 1 | 26519 | |
| 1 1/2 1/2 | 26521 | |
| 1 1/2 3/4 | 26522 | |
| 1 1/2 1 | 26523 | |
| 2 1/2 | 26524 | |
| 2 3/4 | 26525 | |
| 2 1 | 26526 | |
| 2 1/2 3/4 | 26527 | |
| 2 1/2 1 | 26528 | |
| 3 3/4 | 26529 | |
| 3 1 | 26530 | |
| 4 3/4 | 26531 | |
| 4 1 | 26532 | |
| 4 1 1/4 | 51066 | |
| 4 2 | 41565 | |

ADDITIONAL CAST IRON FITTINGS READY FOR QUICK DELIVERY!



Concentric Reducer



Cross Straight or Reducing



Lateral



Return Bend



Flanged Union

CAST IRON FITTINGS ALSO AVAILABLE IN EXTRA HEAVY (250 LB.)

For additional information call: 610-275-4453 or Fax: 610-279-6299
Please call for current prices.

125 LB. CAST IRON SCREWED REDUCING TEE

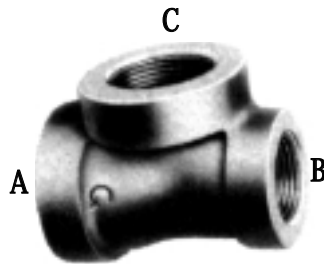

| SIZE | | | FIG | PRICE |
|-------|-------|-------|-------|-------|
| A | B | C | | |
| 1/2 | 1/2 | 3/4 | 994 | |
| 1/2 | 1/2 | 1 | 36516 | |
| 3/4 | 1/2 | 1/2 | 995 | |
| 3/4 | 1/2 | 3/4 | 996 | |
| 3/4 | 3/4 | 1/4 | 32710 | |
| 3/4 | 3/4 | 3/8 | 32711 | |
| 3/4 | 3/4 | 1/2 | 5600 | |
| 1 | 1/2 | 1/2 | 998 | |
| 1 | 1/2 | 3/4 | 999 | |
| 1 | 1/2 | 1 | 1000 | |
| 1 | 3/4 | 1/2 | 5601 | |
| 1 | 3/4 | 3/4 | 1001 | |
| 1 | 3/4 | 1 | 1002 | |
| 1 | 3/4 | 1 1/2 | 39331 | |
| 1 | 3/4 | 2 | 39323 | |
| 1 | 1 | 1/4 | 32713 | |
| 1 | 1 | 3/8 | 36517 | |
| 1 | 1 | 1/2 | 1003 | |
| 1 | 1 | 3/4 | 1004 | |
| 1 | 1 | 1 1/4 | 5602 | |
| 1 | 1 | 1 1/2 | 32714 | |
| 1 1/4 | 3/4 | 3/4 | 1005 | |
| 1 1/4 | 3/4 | 1 | 5604 | |
| 1 1/4 | 3/4 | 1 1/4 | 1006 | |
| 1 1/4 | 3/4 | 1 1/2 | 39322 | |
| 1 1/4 | 3/4 | 2 | 39324 | |
| 1 1/4 | 1 | 1/2 | 1009 | |
| 1 1/4 | 1 | 3/4 | 1010 | |
| 1 1/4 | 1 | 1 | 1011 | |
| 1 1/4 | 1 | 1 1/4 | 1012 | |
| 1 1/4 | 1 | 1 1/2 | 32715 | |
| 1 1/4 | 1 | 2 | 32716 | |
| 1 1/4 | 1 1/4 | 1/2 | 1013 | |
| 1 1/4 | 1 1/4 | 3/4 | 1014 | |
| 1 1/4 | 1 1/4 | 1 | 1015 | |
| 1 1/4 | 1 1/4 | 1 1/2 | 1016 | |
| 1 1/4 | 1 1/2 | 2 | 32717 | |
| 1 1/2 | 1/2 | 1 1/4 | 5607 | |
| 1 1/2 | 1/2 | 1 1/2 | 1018 | |
| 1 1/2 | 3/4 | 1/2 | 5610 | |
| 1 1/2 | 3/4 | 3/4 | 1020 | |
| 1 1/2 | 3/4 | 1 | 5609 | |
| 1 1/2 | 3/4 | 1 1/4 | 5608 | |
| 1 1/2 | 3/4 | 1 1/2 | 1019 | |
| 1 1/2 | 1 | 1 | 1021 | |
| 1 1/2 | 1 | 1 1/4 | 5612 | |
| 1 1/2 | 1 | 1 1/2 | 1022 | |
| 1 1/2 | 1 1/4 | 1/2 | 21181 | |
| 1 1/2 | 1 1/4 | 3/4 | 5613 | |
| 1 1/2 | 1 1/4 | 1 | 5614 | |
| 1 1/2 | 1 1/4 | 1 | 1023 | |
| 1 1/2 | 1 1/4 | 1 | 1024 | |
| 1 1/2 | 1 1/4 | 2 | 32718 | |
| 1 1/2 | 1 1/2 | 3/8 | 39334 | |

| SIZE | | | FIG | PRICE |
|-------|-------|-------|-------|-------|
| A | B | C | | |
| 1 1/2 | 1 1/2 | 1/2 | 1025 | |
| 1 1/2 | 1 1/2 | 3/4 | 1026 | |
| 1 1/2 | 1 1/2 | 1 | 1027 | |
| 1 1/2 | 1 1/2 | 1 1/4 | 1028 | |
| 1 1/2 | 1 1/2 | 2 | 1029 | |
| 2 | 1/2 | 2 | 1030 | |
| 2 | 3/4 | 1 1/4 | 5618 | |
| 2 | 3/4 | 1 1/2 | 5616 | |
| 2 | 3/4 | 2 | 1031 | |
| 2 | 1 | 3/4 | 39330 | |
| 2 | 1 | 1 | 32720 | |
| 2 | 1 | 1 1/4 | 5620 | |
| 2 | 1 | 1 1/2 | 5619 | |
| 2 | 1 | 2 | 1032 | |
| 2 | 1 1/4 | 1 | 32721 | |
| 2 | 1 1/4 | 1 1/4 | 1033 | |
| 2 | 1 1/4 | 1 1/2 | 5621 | |
| 2 | 1 1/4 | 2 | 1034 | |
| 2 | 1 1/2 | 1/2 | 20597 | |
| 2 | 1 1/2 | 3/4 | 23495 | |
| 2 | 1 1/2 | 1 | 23496 | |
| 2 | 1 1/2 | 1 1/4 | 5622 | |
| 2 | 1 1/2 | 1 1/2 | 1035 | |
| 2 | 1 1/2 | 2 | 1036 | |
| 2 | 2 | 1/2 | 1037 | |
| 2 | 2 | 3/4 | 1038 | |
| 2 | 2 | 1 | 1039 | |
| 2 | 2 | 1 1/4 | 1040 | |
| 2 | 2 | 1 1/2 | 1041 | |
| 2 | 2 | 2 1/2 | 32722 | |
| 2 | 2 | 3 | 32723 | |
| 2 1/2 | 2 | 1 1/2 | 32733 | |
| 2 1/2 | 2 | 2 | 1044 | |
| 2 1/2 | 2 | 2 1/2 | 1045 | |
| 2 1/2 | 2 1/2 | 1/2 | 1046 | |
| 2 1/2 | 2 1/2 | 3/4 | 1047 | |
| 2 1/2 | 2 1/2 | 1 | 1048 | |
| 2 1/2 | 2 1/2 | 1 1/4 | 1049 | |
| 2 1/2 | 2 1/2 | 1 1/2 | 1050 | |
| 2 1/2 | 2 1/2 | 2 | 1051 | |
| 3 | 1 | 3 | 5626 | |
| 3 | 1 1/4 | | 5627 | |
| 3 | 1 1/2 | 2 1/2 | 32735 | |
| 3 | 1 1/2 | 3 | 1052 | |
| 3 | 2 | 1 1/2 | 32736 | |
| 3 | 2 | 2 | 1053 | |
| 3 | 2 | 2 1/2 | 32737 | |
| 3 | 2 | 3 | 1054 | |
| 3 | 2 1/2 | 1 | 32738 | |
| 3 | 2 1/2 | 1 1/4 | 32739 | |
| 3 | 2 1/2 | 1 1/2 | 32740 | |
| 3 | 2 1/2 | 2 | 32741 | |
| 3 | 2 1/2 | 2 1/2 | 1055 | |
| 3 | 2 1/2 | 3 | 1056 | |
| 3 | 3 | 1/2 | 32742 | |
| 3 | 3 | 3/4 | 1057 | |
| 3 | 3 | 1 | 1058 | |
| 3 | 3 | 1 1/4 | 1059 | |
| 3 | 3 | 1 1/2 | 1060 | |
| 3 | 3 | 2 | 1061 | |
| 3 | 3 | 2 1/2 | 1062 | |
| 3 | 3 | 4 | 32743 | |

CAST IRON FLANGES

COMPANION
FLANGES
(Threaded)

BLIND
FLANGES





**YES!
WE ACCEPT VISA
AND MASTERCARD!**

| 125 LB. STANDARD | | | | |
|------------------|--------|-----------|-------|--------------|
| SIZE | O.D. | COMPANION | | BLIND |
| | | FIG NO | PRICE | FIG NO PRICE |
| 3/4 | 3 7/8 | 12011 | - | - |
| 1 | 4 1/4 | 12018 | - | 12039 |
| 1 1/4 | 4 5/8 | 1180 | - | 12045 |
| 1 1/2 | 5 | 1181 | - | 12046 |
| 2 | 6 | 1182 | - | 12048 |
| 2 1/2 | 7 | 1183 | - | 12049 |
| 3 | 7 1/2 | 1184 | - | 12050 |
| 3 1/2 | 8 1/2 | 12022 | - | 12052 |
| 4 | 9 | 1185 | - | 12054 |
| 5 | 10 | 5636 | - | 12055 |
| 6 | 11 | 1186 | - | 12057 |
| 7 | 13 1/2 | 12029 | - | - |
| 8 | - | - | - | 12058 |
| 10 | 16 | 12032 | - | 12061 |
| 12 | 19 | 19537 | - | 12063 |

| 250LB. STANDARD | | |
|-----------------|-----------|-------|
| SIZE | COMPANION | |
| | FIG NO | PRICE |
| - | - | - |
| - | - | - |
| - | - | - |
| - | - | - |
| 2 X 6 1/2 | 18314 | - |
| 2 1/2 X 7 1/2 | 18315 | - |
| 3 X 8 1/4 | 18316 | - |
| 9 | - | - |
| 4 X 10 | 18317 | - |
| 11 | - | - |
| 6 X 12 1/2 | 18318 | - |
| - | - | - |
| - | - | - |
| - | - | - |

REDUCING
FLANGE

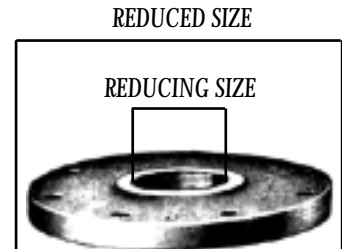

FLANGE
BOLTS AND
NUTS



| SIZE | BOLT | HEAVY HEX NUT | | WASHER | |
|------|-------|---------------|-------|--------|-------|
| | | FIG NO | PRICE | FIG NO | PRICE |
| 1/2 | 2 1/4 | 14552 | 14542 | 50642 | - |
| 5/8 | 2 3/4 | 14554 | 14546 | 55291 | - |
| | 3 | 14555 | - | - | - |
| | 3 1/2 | 14557 | - | - | - |
| | 4 1/2 | 23734 | - | - | - |
| | 5 | 24140 | - | - | - |
| | 5 1/2 | 23733 | - | - | - |
| 3/4 | 3 1/4 | 14559 | 14547 | 55486 | - |
| | 3 1/2 | 14562 | - | - | - |
| | 3 3/4 | 14565 | - | - | - |
| 7/8 | 4 | 14566 | 14549 | 14370 | - |

| 125 LB. STANDARD | | | | |
|--------------------------|-------------------------------|----------------------------|--------|-------|
| Reduced Size Flange O.D. | Reducing Size (Threaded Size) | Reduced Size (Flange Size) | FIG NO | PRICE |
| 6 | 1 1/2 | 2 | 32776 | - |
| 7 | 2 | 2 1/2 | 12064 | - |
| 7 1/2 | 1 1/2 | 3 | 32777 | - |
| 7 1/2 | 2 | 3 | 12065 | - |
| 7 1/2 | 2 1/2 | 3 | 12068 | - |
| 9 | 2 | 4 | 12070 | - |
| 9 | 2 1/2 | 4 | 12072 | - |
| 9 | 3 | 4 | 12075 | - |
| 10 | 2 1/2 | 5 | 19493 | - |
| 10 | 3 | 5 | 12077 | - |
| 10 | 4 | 5 | 12082 | - |
| 11 | 2 1/2 | 6 | 19494 | - |
| 11 | 3 | 6 | 12085 | - |
| 11 | 4 | 6 | 12086 | - |
| 11 | 5 | 6 | 20774 | - |
| 13 1/2 | 6 | 8 | 32778 | - |

125 LB. CAST IRON FLANGED FITTINGS

(STANDARD, BLACK, FACED AND DRILLED)



90° Elbow



45° Elbow



Tee



Cross



Concentric Reducer

| Size | Fig No | Price | Fig No | Price | Fig No | Price | Fig No | Price | Size | Fig No | Price |
|-------|--------|-------|--------|-------|--------|-------|--------|-------|---------|--------|-------|
| 2 1/2 | 12089 | | 12100 | | 12112 | | 23499 | | 3x2 1/2 | 12116 | |
| 3 | 12092 | | 12106 | | 12113 | | 23500 | | 3x2 | 12119 | |
| 4 | 12095 | | 12108 | | 12114 | | 22265 | | 4x3 | 12120 | |
| 5 | 20775 | | - | | 22479 | | 23501 | | 4x2 | 12121 | |
| 6 | 12097 | | 12109 | | 12115 | | 23502 | | 5x3 | 23768 | |
| | | | | | | | | | 5x4 | 22725 | |
| | | | | | | | | | 6x4 | 12122 | |
| | | | | | | | | | 6x3 | 12124 | |



Reducing 90° Elbow



Wye

BOTH AVAILABLE FOR QUICK DELIVERY!

FLANGED FITTINGS ALSO AVAILABLE IN EXTRA HEAVY (250LB.)

FLANGE GASKETS

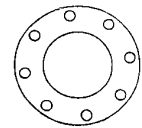
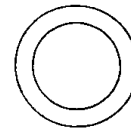
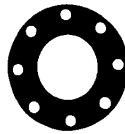
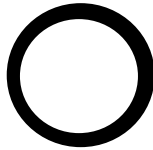

| NON-ASBESTOS | | | | | | | | | | RED RUBBER | | | |
|--------------|--------|-------|--------|-------|-----------|-------|--------|-------|--------|---------------|--------|--------------------|--|
| RING | | | | | FULL FACE | | | | | Ring Standard | | Full Face Standard | |
| Size | Fig No | Price | Fig No | Price | Fig No | Price | Fig No | Price | Fig No | Price | Fig No | Price | |
| 1/2 | 29935 | | 40966 | | 29936 | | 40978 | | 23555 | | 29939 | | |
| 3/4 | 23177 | | 40967 | | 29937 | | 40979 | | 27955 | | 29940 | | |
| 1 | 8003 | | 36007 | | 8065 | | 40980 | | 8103 | | 8145 | | |
| 1 1/4 | 8007 | | 40968 | | 8067 | | 40981 | | 8107 | | 8149 | | |
| 1 1/2 | 8012 | | 36008 | | 8070 | | 40982 | | 8112 | | 8152 | | |
| 2 | 8019 | | 40969 | | 8073 | | 35698 | | 8114 | | 8154 | | |
| 2 1/2 | 8022 | | 40970 | | 8076 | | 35696 | | 8118 | | 8156 | | |
| 3 | 8025 | | 35975 | | 8079 | | 40983 | | 8120 | | 8160 | | |
| 3 1/2 | 8029 | | 40971 | | 8082 | | 40984 | | 8124 | | 8163 | | |
| 4 | 8032 | | 40972 | | 8085 | | 40985 | | 8126 | | 8166 | | |
| 5 | 8039 | | 40973 | | 8088 | | 40986 | | 8129 | | 8167 | | |
| 6 | 8050 | | 40974 | | 8089 | | 40987 | | 8133 | | 8171 | | |
| 8 | 8054 | | 40975 | | 8094 | | 40988 | | 8136 | | 67232 | | |
| 10 | 8057 | | 40976 | | 8096 | | 40989 | | 8139 | | 8176 | | |
| 12 | 8061 | | 40977 | | 8099 | | 40990 | | 8142 | | 8178 | | |

FLANGE AND BOLTING DIMENSIONS

| 125 & 150 LB STEEL FLANGES | | | | | | | 250 & 300 LB STEEL FLANGES | | | | | | |
|----------------------------|---------------------|---------------|--------------|-----------------------------------|-------------|-----------|----------------------------|---------------------|---------------|--------------|-----------------------------------|-------------|-----------|
| NOM PIPE SIZE | DIAM OF BOLT CIRCLE | DIAM OF BOLTS | NO. OF BOLTS | LENGTH OF STUDS 1/16" RAISED FACE | BOLT LENGTH | FLANGE OD | NOM PIPE SIZE | DIAM OF BOLT CIRCLE | DIAM OF BOLTS | NO. OF BOLTS | LENGTH OF STUDS 1/16" RAISED FACE | BOLT LENGTH | FLANGE OD |
| 1/2 | 2 3/8 | 1/2 | 4 | 2 1/4 | 1 3/4 | 3 1/2 | 1/2 | 25/8 | 1/2 | 4 | 2 1/2 | 2 | 3 3/4 |
| 3/4 | 2 3/4 | 1/2 | 4 | 2 1/4 | 2 | 3 7/8 | 3/4 | 3 1/4 | 5/8 | 4 | 2 3/4 | 2 1/2 | 4 5/8 |
| 1 | 3 1/8 | 1/2 | 4 | 2 1/2 | 2 | 4 1/4 | 1 | 3 1/2 | 5/8 | 4 | 3 | 2 1/2 | 4 7/8 |
| 1 1/4 | 3 1/2 | 1/2 | 4 | 2 1/2 | 2 1/4 | 4 5/8 | 1 1/4 | 3 7/8 | 5/8 | 4 | 3 | 2 3/4 | 5 1/4 |
| 1 1/2 | 3 7/8 | 1/2 | 4 | 2 3/4 | 2 1/4 | 5 | 1 1/2 | 4 1/2 | 3/4 | 4 | 3 1/2 | 3 | 6 1/8 |
| 2 | 4 3/4 | 5/8 | 4 | 3 | 2 3/4 | 6 | 2 | 5 | 5/8 | 8 | 3 1/4 | 3 | 6 1/2 |
| 2 1/2 | 5 1/2 | 5/8 | 4 | 3 1/4 | 3 | 7 | 2 1/2 | 5 7/8 | 3/4 | 8 | 3 3/4 | 3 1/4 | 7 1/2 |
| 3 | 6 | 5/8 | 4 | 3 1/2 | 3 | 7 1/2 | 3 | 6 5/8 | 3/4 | 8 | 4 | 3 1/2 | 8 1/4 |
| 3 1/2 | 7 | 5/8 | 8 | 3 1/2 | 3 | 8 1/2 | 3 1/2 | 7 1/4 | 3/4 | 8 | 4 1/4 | 3 3/4 | 9 |
| 4 | 7 1/2 | 5/8 | 8 | 3 1/2 | 3 | 9 | 4 | 7 7/8 | 3/4 | 8 | 4 1/4 | 3 3/4 | 10 |
| 5 | 8 1/2 | 3/4 | 8 | 3 3/4 | 3 1/4 | 10 | 5 | 9 1/4 | 3/4 | 8 | 4 1/2 | 4 | 11 |
| 6 | 9 1/2 | 3/4 | 8 | 3 3/4 | 3 1/4 | 11 | 6 | 10 5/8 | 3/4 | 12 | 4 3/4 | 4 1/4 | 12 1/2 |
| 8 | 11 3/4 | 3/4 | 8 | 4 | 3 1/2 | 13 1/2 | 8 | 13 | 7/8 | 12 | 5 1/4 | 4 3/4 | 15 |
| 10 | 14 1/4 | 7/8 | 12 | 4 1/2 | 3 3/4 | 16 | 10 | 15 1/4 | 1 | 16 | 6 | 5 1/4 | 17 1/2 |
| 12 | 17 | 7/8 | 12 | 4 1/2 | 4 | 19 | 12 | 17 3/4 | 1 1/8 | 16 | 6 1/2 | 5 3/4 | 20 1/2 |
| 14 | 18 3/4 | 1 | 12 | 5 | 4 1/4 | 21 | 14 | 20 1/4 | 1 1/8 | 20 | 6 3/4 | 6 | 23 |
| 16 | 21 1/4 | 1 | 16 | 5 1/4 | 4 1/2 | 23 1/2 | 16 | 22 1/2 | 1 1/4 | 20 | 7 1/4 | 6 1/2 | 25 1/2 |
| 18 | 22 3/4 | 1 1/8 | 16 | 5 3/4 | 4 3/4 | 25 | 18 | 24 3/4 | 1 1/4 | 24 | 7 1/2 | 6 3/4 | 28 |
| 20 | 25 | 1 1/8 | 20 | 6 | 5 1/4 | 27 1/2 | 20 | 27 | 1 1/4 | 24 | 8 | 7 | 30 1/2 |
| 22 | 27 1/4 | 1 1/4 | 20 | 6 1/2 | 5 1/2 | 29 1/2 | 22 | 29 1/4 | 1 1/2 | 24 | 8 3/4 | 7 1/2 | 33 |
| 24 | 29 1/2 | 1 1/4 | 20 | 6 3/4 | 5 3/4 | 32 | 24 | 32 | 1 1/2 | 24 | 9 | 7 3/4 | 36 |
| 26 | 31 3/4 | 1 1/4 | 24 | 7 | 6 | 34 1/4 | 26 | 34 1/2 | 1 5/8 | 28 | 10 | 8 3/4 | 38 1/4 |
| 30 | 36 | 1 1/4 | 28 | 7 1/4 | 6 1/4 | 38 3/4 | 30 | 39 1/4 | 1 3/4 | 28 | 11 1/4 | 10 | 43 |
| 34 | 40 1/2 | 1 1/2 | 32 | 8 | 7 | 43 3/4 | 34 | 43 1/2 | 1 7/8 | 28 | 12 1/4 | 10 3/4 | 47 1/2 |
| 36 | 42 3/4 | 1 1/2 | 32 | 8 1/4 | 7 | 46 | 36 | 46 | 2 | 32 | 12 3/4 | 11 1/4 | 50 |
| 42 | 49 1/2 | 1 1/2 | 36 | 8 3/4 | 7 1/2 | 53 | 42 | 42 3/4 | 2 | 36 | 13 3/4 | 13 1/2 | 57 |

Stud lengths for lap joint flanges are equal to lengths shown plus the thickness of two laps of the stub ends

DUFF TIP → Bolting arrangement for 125 lb. cast iron flanges are the same as shown for 150 lb. steel flanges.

DUFF TIP → Bolting arrangement for 250 lb. cast iron flanges are the same as shown for 300 lb. steel flanges.

FLEXITALLIC GASKETS

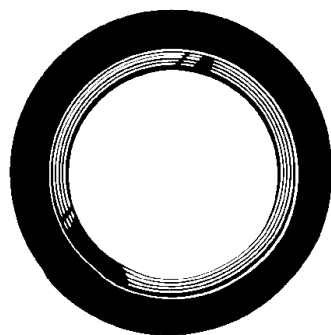

Flexitallic Gaskets - The solid metal compression ring make the gasket easier to install and adds to service life. As a simple centering device, it provides fast accurate seating of the gasket in the flange. During "bolt-up", it prevents crushing the gasket beyond the predetermined thickness. In operation, it eliminates excess strain on studs. The solid compression ring resists radial pressure,

thus preventing blowout of the spirally wound area. Recommended for standard piping where superior service life is required under wide variations in pressure and/or temperature.

300# ALSO AVAILABLE!

| 150# | | Price |
|--------|--------|-------|
| Size | Fig No | |
| 1/2" | 58311 | |
| 3/4" | 58312 | |
| 1" | 58314 | |
| 1 1/4" | 59635 | |
| 1 1/2" | 58316 | |
| 2" | 57667 | |
| 3" | 57908 | |
| 4" | 58329 | |
| 5" | 58320 | |
| 6" | 58321 | |
| 8" | 58323 | |
| 10" | 57925 | |
| 12" | 57926 | |
| 14" | 57927 | |

PIPE WEIGHTS AND WALL THICKNESS

| PIPE SIZES | O.D. in Inches | SCHEDULE | | | | | | | | | | | | | |
|------------|----------------|--------------|--------------|--------------|--------------|--------------|--------------|--------------|--------------|--------------|--------------|--------------|--------------|--------------|--------------|
| | | 5 | 10 | 20 | 30 | 40 | STD | 60 | 80 | E.H | 100 | 120 | 140 | 160 | Dble. E.H. |
| 1/8 | .405 | .035 | .049 | | | .068 | .068 | | .095 | .095 | | | | | |
| | | 1383 | 1383 | | | 2447 | 2447 | | 3145 | 3145 | | | | | |
| 1/4 | .540 | .049 | .065 | | | .088 | .088 | | .119 | .119 | | | | | |
| | | 2570 | 3297 | | | 4248 | 4248 | | 5351 | 5351 | | | | | |
| 3/8 | .675 | .049 | .065 | | | .091 | .091 | | .126 | .126 | | | | | |
| | | 3276 | 4235 | | | 5676 | 5676 | | 7388 | 7388 | | | | | |
| 1/2 | .840 | .065 | .083 | | | .109 | .109 | | .147 | .147 | | | | .187 | .294 |
| | | 5383 | 6710 | | | 8510 | 8510 | | 1088 | 1088 | | | | 1304 | 1714 |
| 3/4 | 1.050 | .065 | .083 | | | .113 | .113 | | .154 | .154 | | | | .218 | .308 |
| | | 6838 | 8572 | | | 1131 | 1131 | | 1474 | 1474 | | | | 1937 | 2441 |
| 1 | 1.315 | .065 | .109 | | | .133 | .133 | | .179 | .179 | | | | .250 | .358 |
| | | 8678 | 1404 | | | 1679 | 1679 | | 2172 | 2172 | | | | 3765 | 3659 |
| 1 1/4 | 1.660 | .065 | .109 | | | .140 | .140 | | .191 | .191 | | | | .250 | .382 |
| | | 1107 | 1806 | | | 2273 | 2273 | | 2997 | 2997 | | | | 3765 | 5214 |
| 1 1/2 | 1.900 | .065 | .109 | | | .145 | .145 | | .200 | .200 | | | | .281 | .400 |
| | | 1274 | 2085 | | | 2718 | 2718 | | 3631 | 3631 | | | | 4859 | 6408 |
| 2 | 2.375 | .065 | .109 | | | .154 | .154 | | .218 | .218 | | | | .343 | .436 |
| | | 1604 | 2638 | | | 3653 | 3653 | | 5022 | 5022 | | | | 7444 | 9029 |
| 2 1/2 | 2.875 | .083 | .120 | | | .203 | .203 | | .276 | .276 | | | | .375 | .552 |
| | | 2475 | 3531 | | | 5793 | 5793 | | 7661 | 7661 | | | | 1001 | 1370 |
| 3 | 3.5 | .083 | .120 | | | .216 | .216 | | .300 | .300 | | | | .437 | .600 |
| | | 3029 | 4332 | | | 7576 | 7576 | | 1025 | 1025 | | | | 1432 | 1858 |
| 3 1/2 | 4.0 | .083 | .120 | | | .226 | .226 | | .381 | .381 | | | | | .636 |
| | | 3472 | 4973 | | | 9109 | 9109 | | 1251 | 1251 | | | | | 2285 |
| 4 | 4.50 | .083 | .120 | | | .237 | .237 | .281 | .337 | .337 | | .437 | | .531 | .674 |
| | | 3915 | 5613 | | | 1079 | 1079 | 12.66 | 14.98 | 14.98 | | 19.01 | | 22.51 | 27.54 |
| 4 1/2 | 5.0 | | | | | | .247 | | | .355 | | | | | .710 |
| | | | | | | | 12.53 | | | 17.61 | | | | | 32.53 |
| 5 | 5.563 | .109 | .134 | | | .258 | .258 | | .375 | .375 | | .500 | | .625 | .750 |
| | | 6349 | 7770 | | | 14.62 | 14.62 | | 20.78 | 20.78 | | 27.04 | | 32.96 | 38.55 |
| 6 | 6.625 | .109 | .134 | | | .280 | .280 | | .432 | .432 | | .562 | | .718 | .864 |
| | | 7585 | 9289 | | | 18.97 | 18.97 | | 28.57 | 28.57 | | 36.39 | | 45.30 | 53.16 |
| 7 | | | | | | | .301 | | | .500 | | | | | .875 |
| | | | | | | | 23.57 | | | 38.05 | | | | | 63.08 |
| 8 | | .109 | .148 | .250 | .277 | .322 | .322 | .406 | .500 | .500 | .593 | .718 | .812 | .906 | 8.75 |
| | | 9.914 | 13.40 | 22.36 | 24.70 | 28.55 | 28.55 | 35.64 | 43.39 | 43.39 | 50.87 | 60.93 | 67.76 | 74.69 | 72.42 |
| 9 | | | | | | | .342 | | | .500 | | | | | |
| | | | | | | | 33.90 | | | 48.72 | | | | | |
| 10 | | .134 | .165 | .250 | .307 | .365 | .365 | .500 | .593 | .500 | .718 | .843 | 1.000 | 1.125 | |
| | | 15.19 | 18.70 | 28.04 | 34.24 | 40.48 | 40.48 | 54.74 | 64.33 | 54.74 | 76.93 | 89.20 | 104.1 | 115.7 | |
| 11 | | | | | | | .375 | | | .500 | | | | | |
| | | | | | | | 45.55 | | | 60.07 | | | | | |
| 12 | | .165 | .180 | .250 | .330 | .406 | .375 | .562 | .687 | .500 | .843 | 1.000 | 1.125 | 1.312 | |
| | | 22.18 | 24.20 | 33.38 | 43.77 | 53.53 | 49.56 | 73.16 | 88.51 | 65.42 | 107.2 | 125.5 | 139.7 | 160.3 | |
| 14 | | .250 | .312 | .375 | .437 | .437 | .375 | .593 | .750 | .500 | .937 | 1.093 | 1.250 | 1.406 | |
| | | | 36.71 | 45.68 | 54.57 | 63.37 | 54.57 | 84.91 | 106.1 | 72.09 | 130.7 | 150.7 | 170.2 | 189.1 | |
| 16 | | .250 | .312 | .375 | .500 | .357 | .357 | 6.56 | 8.43 | .500 | 1.031 | 1.218 | 1.437 | 1.593 | |
| | | | 42.05 | 52.36 | 62.58 | 82.77 | 62.58 | 107.5 | 136.5 | 82.77 | 164.8 | 192.3 | 223.5 | 245.1 | |
| 18 | | .250 | .312 | .437 | .562 | .375 | .375 | .750 | .937 | .500 | 1.156 | 1.375 | 1.562 | 1.781 | |
| | | | 47.39 | 59.03 | 82.06 | 104.8 | 70.59 | 138.2 | 170.8 | 93.45 | 208.0 | 244.1 | 274.2 | 308.5 | |
| 20 | | .250 | .375 | .500 | .593 | .375 | .375 | .812 | 1.031 | .500 | 1.280 | 1.500 | 1.750 | 1.968 | |
| | | | 52.73 | 78.60 | 104.1 | 122.9 | 78.60 | 166.4 | 208.9 | 104.1 | 256.1 | 296.4 | 341.1 | 379.0 | |
| 22 | | .250 | .375 | .500 | | .375 | .375 | .875 | 1.125 | .500 | 1.375 | 1.625 | 1.875 | 2.125 | |
| | | | 58.07 | 86.61 | 114.8 | | 86.61 | 197.4 | 250.8 | 114.8 | 302.9 | 353.6 | 403.0 | 451.1 | |
| 24 | | .250 | .375 | .562 | .687 | .375 | .375 | .968 | 1.218 | .500 | 1.531 | 1.812 | 2.062 | 2.343 | |
| | | | 63.41 | 94.62 | 140.8 | 171.2 | 94.62 | 238.1 | 296.4 | 125.5 | 367.4 | 429.4 | 483.1 | 541.9 | |

Dark Figures - Wall Thickness in Inches *Italic Figures - Weight Per Foot in Pounds*

PIPE

| STEEL | | | | | | | | | | BRASS | | | | CHROME PLATED BRASS | |
|-----------------------------|----------|-------------------------------|----------|-----------------|---------------------------|-----------------|----------|-------|-------------|-------------|----------|-------------|------------|---------------------|--|
| SCHEDULE 40 (Standard Wall) | | | | | SCHEDULE 80 (Extra Heavy) | | | | | SCHEDULE 40 | | SCHEDULE 80 | | SCHEDULE 40 | |
| BLACK Threaded & Coupled | | GALVANIZED Threaded & Coupled | | BLACK Plain End | | BLACK Plain End | | | 12' Lengths | | | | 6' Lengths | | |
| SIZE | FIG. NO. | PRICE | FIG. NO. | PRICE | FIG. NO. | PRICE | FIG. NO. | PRICE | FIG. NO. | PRICE | FIG. NO. | PRICE | FIG. NO. | PRICE | |
| 1/8 | 13478 | | 13570 | | - | | 13492 | | 21146 | | | | - | | |
| 1/4 | 13571 | | 10 | | - | | 5333 | | 7665 | | | | - | | |
| 3/8 | 2 | | 11 | | - | | 5334 | | 7666 | | | | 12657 | | |
| 1/2 | 8815 | | 12 | | 13479 | | 5335 | | 7667 | | | | 12659 | | |
| 3/4 | 5677 | | 13 | | 13480 | | 5336 | | 7668 | | | | 12676 | | |
| 1 | 3 | | 14 | | 13481 | | 5337 | | 7672 | | | | 12677 | | |
| 1 1/4 | 4 | | 15 | | 13482 | | 5338 | | 7673 | | | | 12679 | | |
| 1 1/2 | 5 | | 16 | | 13483 | | 5339 | | 7674 | | | | 12686 | | |
| 2 | 6 | | 17 | | 13484 | | 5340 | | 7675 | | | | 12689 | | |
| 2 1/2 | 7 | | 18 | | 13485 | | 5341 | | - | | | | - | | |
| 3 | 8 | | 19 | | 13486 | | 5342 | | 7677 | | | | - | | |
| 3 1/2 | 5343 | | - | | 13488 | | - | | | | | | | | |
| 4 | 9 | | 13504 | | 13489 | | 13496 | | | | | | | | |
| 5 | - | | - | | 13563 | | - | | | | | | | | |
| 6 | - | | - | | 13564 | | - | | | | | | | | |
| 8 | - | | - | | 13565 | | - | | | | | | | | |
| 10 | - | | - | | 13566 | | - | | | | | | | | |
| 12 | - | | - | | 13569 | | - | | | | | | | | |

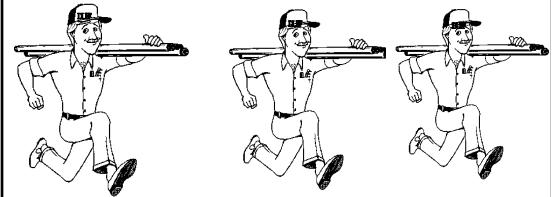

*Steel pipe provided in 21 ft. lengths through 4". Sizes 5" and above are provided in single random lengths, 17 ft. through 22 ft. Prices are per length through 4" and per foot for 5" and above.

*Larger size and heavier wall pipe are always available from stock. As in seamless, pressure pipe and tubing in all sizes and wall thicknesses.

CALL FOR GLASS PIPE,
TEFLON LINED PIPE,
ALLOY PIPE, ALL TYPES
OF EXTRUCCOATED
(COATED FOR GAS
SERVICE) PIPE.

*Structural pipe and used pipe always available.

*Pipe cut to size upon request.

*Galvanized schedule 80 is also available.

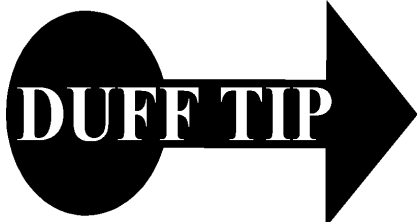

The outside diameter of all pipe is always the same, no matter what the wall thickness is! For example, 1/2" nominal pipe always has an OD of .84, whether it is schedule 40 or schedule 80 steel, brass, PVC, etc.

PIPE OUTSIDE DIAMETER GUIDE

IMPORTANT: This pipe OD guide is furnished for your convenience and is based on the latest pipe standards and information supplied by pipe manufacturers. Due to occasional changes in outside diameters by pipe manufacturers, the pipe OD or circumference should always be checked and furnished when ordering fittings.

| Nominal Pipe Size (Inches) | 1/2 | 3/4 | 1 | 1 1/4 | 1 1/2 | 2 | 2 1/2 | 3 | 4 | 5 | 6 | 8 | 10 | 12 | 14 | 15 | 16 | 18 | 20 | 24 | 30 | |
|---------------------------------|--|------|------|-------|-------|------|-------|------|------|------|------|------|-------|-------|-------|-------|-------|-------|-------|-------|-------|--|
| Copper Tubing | .63 | .88 | 1.13 | 1.38 | 1.63 | 2.13 | 2.63 | 3.13 | 4.13 | 5.13 | 6.13 | | | | | | | | | | | |
| Steel Pipe—Schedule 40 | .84 | 1.05 | 1.32 | 1.66 | 1.90 | 2.38 | 2.88 | 3.50 | 4.50 | 5.56 | 6.63 | 8.63 | 10.75 | 12.75 | 14.00 | | 16.00 | 18.00 | 20.00 | 24.00 | 30.00 | |
| Plastic Pipe—(P.V.C.)—STD | | | 1.32 | | 1.90 | 2.38 | 2.88 | 3.50 | 4.50 | | 6.63 | 8.63 | 10.75 | 12.75 | | | | | | | | |
| Plastic Pipe—(P.V.C.)—C.I. Size | | | | | | | | | 4.80 | | 6.90 | 9.05 | 11.10 | 13.20 | | | | | | | | |
| Polyethylene Tubing & Pipe | P.E. Tubing Can Be To Iron Copper D-Schedule 40 Size | | | | | | | 3.50 | 4.50 | | 6.63 | 8.63 | 10.75 | 12.75 | 14.00 | | 16.00 | 18.00 | 20.00 | 24.00 | | |
| Polyethylene Pipe—"Sclair" | | | | | | 2.38 | | 3.50 | 4.50 | | 6.63 | 8.63 | 9.90 | 12.47 | 14.05 | | 15.85 | 17.87 | 19.84 | 25.02 | | |
| Plastic Irrigation Pipe (PIP) | | | | | | | | | 4.13 | | 6.14 | 8.16 | 10.20 | 12.24 | | 15.30 | | | | | | |

CAST IRON PIPE

| | | | | | | | | | | | | | | | | | | | | | | |
|--------------------------------|--|--|--|--|--|------|--|------|------|--|------|------|-------|-------|-------|--|-------|-------|-------|-------|-------|--|
| Class 100-250 AWWA Centrifugal | | | | | | | | 3.96 | 4.80 | | 6.90 | 9.05 | 11.10 | 13.20 | 15.30 | | 17.40 | 19.50 | 21.60 | 25.80 | 32.00 | |
| Class A AWWA Pit Cast | | | | | | 2.50 | | 3.80 | 4.80 | | 6.90 | 9.05 | 11.10 | 13.20 | 15.30 | | 17.40 | 19.50 | 21.60 | 25.80 | 31.74 | |
| Class B AWWA Pit Cast | | | | | | | | 3.96 | 5.00 | | 7.10 | 9.05 | 11.10 | 13.20 | 15.30 | | 17.40 | 19.50 | 21.60 | 25.80 | 32.00 | |
| Class C-D AWWA Pit Cast | | | | | | | | 3.96 | 5.00 | | 7.10 | 9.30 | 11.40 | 13.50 | 15.65 | | 17.80 | 19.92 | 22.06 | 26.32 | | |

ASBESTOS-CEMENT PIPE

CLASS 100

| | | | | | | | | | | | | | | | | | | | | | | |
|-------------------------------|--|--|--|--|--|--|--|------|------|--|------|------|--------|--------|-------|--|-------|--|--|--|--|--|
| Machined End | | | | | | | | 3.74 | 4.64 | | 6.91 | 9.11 | 11.24* | 13.44* | 15.07 | | 17.15 | | | | | |
| Fluid-Tite Rough Barrel | | | | | | | | 3.93 | 5.05 | | 7.16 | 9.32 | 11.46 | 13.70 | 15.36 | | 17.50 | | | | | |
| Flintite Rough Barrel | | | | | | | | 3.94 | 4.90 | | 7.13 | 9.33 | 11.30 | 13.42 | 15.45 | | 17.60 | | | | | |
| Ring-Tite Rough Barrel | | | | | | | | 3.95 | 4.92 | | 7.19 | 9.39 | 11.47 | 13.74 | 15.51 | | 17.65 | | | | | |
| Permafex Rough Barrel | | | | | | | | | 4.84 | | 7.15 | 9.35 | 11.47 | 13.74 | 15.55 | | 17.55 | | | | | |
| Minimum Standard Rough Barrel | | | | | | | | | 4.79 | | 7.05 | 9.22 | 11.25 | 13.37 | 15.36 | | 17.50 | | | | | |
| Maximum Standard Rough Barrel | | | | | | | | | 5.26 | | 7.40 | 9.57 | 11.77 | 14.04 | 15.80 | | 17.94 | | | | | |

CLASS 150

| | | | | | | | | | | | | | | | | | | | | | | |
|-------------------------------|--|--|--|--|--|--|--|------|------|--|------|------|-------|-------|-------|--|-------|--|--|--|--|--|
| Machined End | | | | | | | | 3.84 | 4.81 | | 6.91 | 9.11 | 11.66 | 13.92 | 16.22 | | 18.46 | | | | | |
| Fluid-Tite Rough Barrel | | | | | | | | 4.03 | 5.14 | | 7.12 | 9.32 | 11.85 | 14.11 | 16.41 | | 18.65 | | | | | |
| Flintite Rough Barrel | | | | | | | | 4.04 | 5.01 | | 7.13 | 9.33 | 11.88 | 14.14 | 16.48 | | 18.72 | | | | | |
| Ring-Tite Rough Barrel | | | | | | | | 4.13 | 5.07 | | 7.17 | 9.37 | 11.92 | 14.18 | 16.48 | | 18.72 | | | | | |
| Permafex Rough Barrel | | | | | | | | | 5.00 | | 7.20 | 9.40 | 11.92 | 14.20 | 16.50 | | 18.75 | | | | | |
| Minimum Standard Rough Barrel | | | | | | | | | 4.97 | | 7.07 | 9.27 | 11.82 | 14.08 | 16.38 | | 18.62 | | | | | |
| Maximum Standard Rough Barrel | | | | | | | | | 5.32 | | 7.37 | 9.62 | 12.12 | 14.38 | 16.73 | | 18.97 | | | | | |

CLASS 200

| | | | | | | | | | | | | | | | | | | | | | | |
|-------------------------------|--|--|--|--|--|--|--|------|------|--|------|------|-------|-------|-------|--|-------|--|--|--|--|--|
| Machined End | | | | | | | | 3.84 | 4.81 | | 6.91 | 9.11 | 11.66 | 13.92 | 16.22 | | 18.46 | | | | | |
| Fluid-Tite Rough Barrel | | | | | | | | 4.18 | 5.32 | | 7.36 | 9.46 | 11.88 | 14.11 | 16.44 | | 18.74 | | | | | |
| Flintite Rough Barrel | | | | | | | | 4.17 | 5.32 | | 7.26 | 9.44 | 11.88 | 14.14 | 16.53 | | 18.84 | | | | | |
| Ring-Tite Rough Barrel | | | | | | | | 4.17 | 5.33 | | 7.32 | 9.50 | 11.92 | 14.18 | 16.55 | | 18.90 | | | | | |
| Permafex Rough Barrel | | | | | | | | | 5.32 | | 7.26 | 9.50 | 11.95 | 14.20 | 16.55 | | 18.90 | | | | | |
| Minimum Standard Rough Barrel | | | | | | | | | 5.22 | | 7.26 | 9.39 | 11.77 | 14.03 | 16.44 | | 18.74 | | | | | |
| Maximum Standard Rough Barrel | | | | | | | | | 5.57 | | 7.60 | 9.79 | 12.12 | 14.38 | 16.88 | | 19.19 | | | | | |

| 1/2 | 3/4 | 1 | 1 1/4 | 1 1/2 | 2 | 2 1/2 | 3 | 4 | 5 | 6 | 8 | 10 | 12 | 14 | 15 | 16 | 18 | 20 | 24 | 30 |
|-----|-----|---|-------|-------|---|-------|---|---|---|---|---|----|----|----|----|----|----|----|----|----|
|-----|-----|---|-------|-------|---|-------|---|---|---|---|---|----|----|----|----|----|----|----|----|----|

*Flintite ME is 10.89 for 10" and 12.99 for 12" sizes.

IMPORTANT: Please refer to the manufacturers data supplied at time of pipe installation or measure the pipe OD or circumference prior to the ordering of fittings.



Always check pipe OD before ordering repair couplings!

CLAMPS AND COUPLINGS
COMPRESSION COUPLINGS

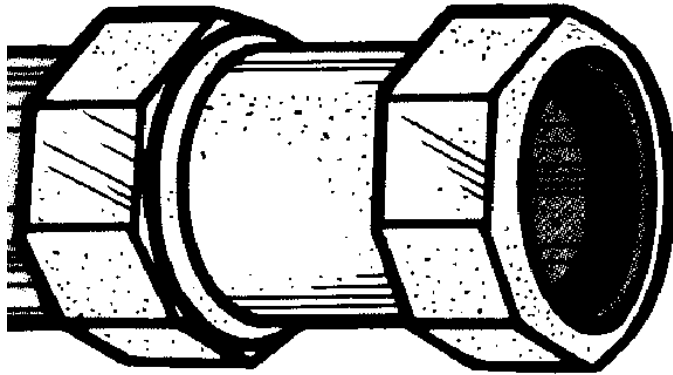

Compression couplings provide a quick, low cost, time proven, simple to install, flexible connection for steel pipe and copper tube.

DEFLECTION-Can accommodate moderate deflection to join misaligned pipe or absorb settlement, or other moderate pipe movement after installation.

LIMITED SPACE-Easy to install in cramped space with no threading or exact cutting of pipe.

JOIN PLAIN END PIPE-Compression coupling join plain end pipe. No threading, grooving, flaring, brazing or welding is necessary. Threading or grooving removes up to 40% of the pipe wall, creating a weakened area.

FAST, SIMPLE INSTALLATION-Simply stab the assembled coupling into the pipe, center and tighten the compression nuts. Requires no special training.

NO EXACT PIPE FITTING-Compression couplings do not require exact cutting and fitting of pipe.

FAST CUT-IN-A pair of compression couplings provide a fast means of replacing a damaged section of pipe or adding valves, meters, regulators, or appliances to a pipeline. Simply cut out a section of pipe and insert the new pipe section or fittings. No threading or exact pipe fitting required.

BETTER THAN UNION-Compression couplings do not require threading or exact cutting of pipe. Are faster and easier to install than ground joint union.

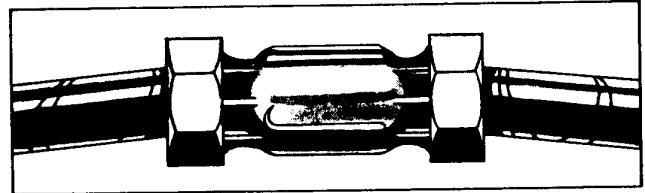

MISALIGNED PIPE Couplings eliminate the need for exact mating of pipe ends. Up to 6° deflection is permissible.

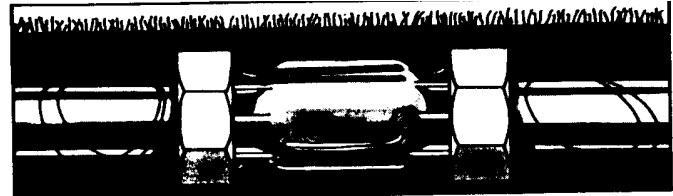

PIPE MOVEMENT After installation, moderate movement of pipe due to external loads, ground settlement or expansion/contraction will not affect the seal. Such conditions create severe stresses in threaded joints or unions.

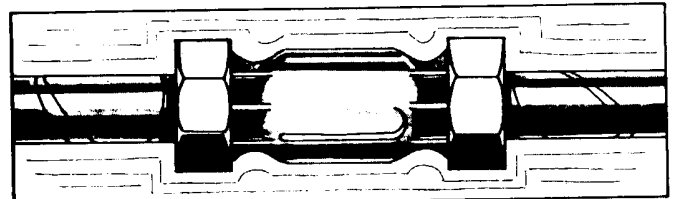

VIBRATION Over a period of time vibration in piping can cause damage creating hazards. Rockwell couplings act as dampeners absorbing vibration and noise.

STEEL

BRASS

| STEEL PIPE SIZE | FIG. NO. | PRICE | COPPER TUBE SIZE | FIG. NO. | PRICE |
|-----------------|----------|-------|------------------|----------|-------|
| 1/2 | 7292 | | 1/2 | 7306 | |
| 3/4 | 17602 | | 3/4 | 7307 | |
| 1 | 7294 | | 1 | 7308 | |
| 1 1/4 | 7295 | | 1 1/4 | 7309 | |
| 1 1/2 | 7296 | | 1 1/2 | 7310 | |
| 2 | 7297 | | 2 | 7317 | |
| 2 1/2 | 7298 | | | | |
| 3 | 7299 | | | | |

OTHER COMPRESSION FITTINGS
AVAILABLE FOR IMMEDIATE DELIVERY

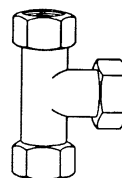

GALVANIZED TEE WITH ARMORED GASKET

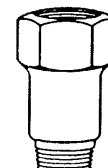

MALE ADAPTER WITH ARMORED GASKET

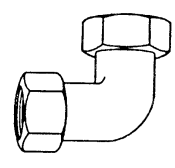

GALVANIZED ELBOW

CLAMPS AND COUPLINGS

REDI-CLAMPS

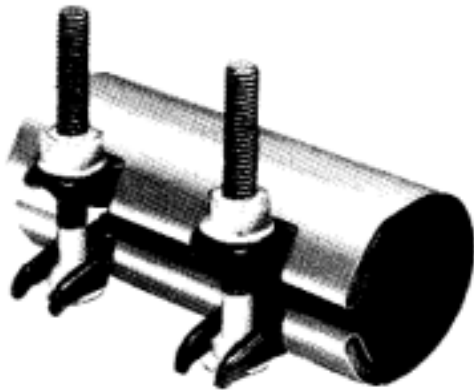

Redi-Clamps provide a fast, economical means of repair for pinholes, punctures or splits in pipe. The gaskets have finely gridded surfaces that will conform to irregularities on the pipe surface and provide superior sealing ability on rough or pitted areas. The bands are stainless steel, selected to meet the exacting requirements of corrosion resistance, flexibility and strength. The lugs are precision cast ductile iron with a contoured surface to equalize clamping pressure around the pipe. The lug design includes a drop-in bolt feature that eliminates loose parts, saves time and aids installation under adverse conditions.

| NOMIAL SIZE | OD IN INCH-ES | WIDTH IN INCHES | FIG. NO. | PRICE |
|-------------|---------------|-----------------|----------|-------|
| 1/2 | .84 | 3 | 7493 | |
| 1/2 | .84 | 6 | 7495 | |
| 3/4 | 1.05 | 3 | 7500 | |
| 3/4 | 1.05 | 6 | 7502 | |
| 1 | 1.32 | 3 | 7526 | |
| 1 | 1.32 | 6 | 7529 | |
| 1 1/4 | 1.66 | 3 | 7539 | |
| 1 1/4 | 1.66 | 6 | 7546 | |
| 1 1/2 | 1.90 | 3 | 7549 | |
| 1 1/2 | 1.90 | 6 | 7551 | |
| 2 | 2.38 | 3 | 7366 | |
| 2 | 2.38 | 6 | 7370 | |
| 2 1/2 | 2.88 | 3 | 7375 | |
| 2 1/2 | 2.88 | 6 | 7376 | |
| 3 | 3.50 | 3 | 7380 | |
| 3 | 3.50 | 6 | 7402 | |
| 3 1/2 | 4.00 | 6 | 39049 | |
| 4 | 4.50 | 3 | 7405 | |
| 4 | 4.50 | 6 | 7408 | |
| 5 | 5.56 | 3 | 7410 | |
| 5 | 5.56 | 6 | 7411 | |
| 6 | 6.63 | 3 | 7423 | |
| 6 | 6.63 | 6 | 7426 | |
| 8 | 8.63 | 3 | 7428 | |
| 8 | 8.63 | 6 | 7430 | |

BOLT-TYPE

Properly installed coupling

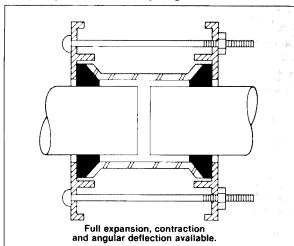

Improperly installed couplings

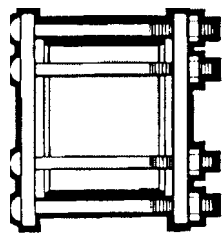
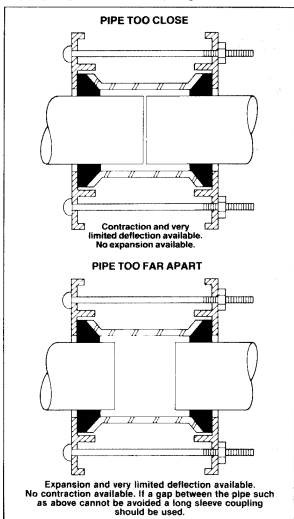

| STEEL PIPE SIZE | OD INCHES | BOLTS | SLEEVE LENGTH INCHES | FIG. NO. | PRICE |
|-----------------|-----------|-------|----------------------|----------|-------|
| 1 1/4 | 1.66 | 2 | 5 | 40028 | |
| 1 1/2 | 1.90 | 2 | 5 | 22399 | |
| 2 | 2.38 | 2 | 5 | 7321 | |
| 2 1/2 | 2.88 | 2 | 5 | 7328 | |
| 3 | 3.50 | 3 | 5 | 17728 | |
| 4 | 4.50 | 4 | 7 | 7334 | |
| 5 | 5.56 | 4 | 7 | 7335 | |
| 6 | 6.63 | 6 | 7 | 7338 | |
| 8 | 8.63 | 6 | 10 | 7340 | |
| 10 | 10.75 | 8 | 10 | 7341 | |

These steel bolt-type couplings are referred to as "Flexible Coupling" or "Mechanical Joints". They provide a flexible, strong, leak-resistant joint. Flexible couplings are designed to float on the pipeline. Therefore, stresses resulting from expansion, contraction and deflection are relieved. The ability of the coupling to absorb deflection permits the laying of pipelines on curves and grades using straight lengths of pipe. Working pressure = Up to 1500 PSI depending on size. Temperature = 150o or higher with special gaskets.

CLAMPS AND COUPLINGS
FULL CIRCLE REPAIR CLAMPS

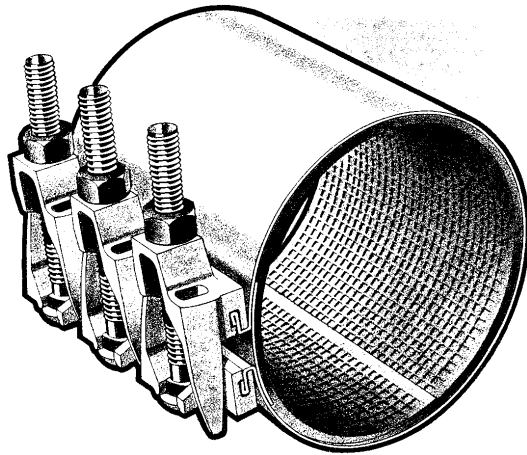

Solves All These Problems

| | |
|--|--|
| Repairs holes | Used as a coupling - allows gap between pipe ends without leakage. |
| Stops leaks through circumferential breaks. | Joins varying pipe sizes to 1/4" difference in diameter. |
| Available in wider selection of lengths for repair of longitudinal splits. | Joins deflected pipe - up to 4° deflection. |
| Joins misaligned pipe - permits 1/8" offset pipe ends. | Joins rough barrel or machined-end Asbestos-cement pipe. |

Flexible repair clamps consisting of one or more stainless steel band sections to which cast lugs are securely attached to accommodate bolts and nuts for the purpose of mounting the clamp on pipe. It has a full encirclement tapered, overlapping, gridded gasket with a flush mounted, bonded-in stainless steel bridge plate to span the band opening between the lugs, to provide a full circumferential seal on the pipe.

A full circle clamp coupling is fast and simple to install, and requires no special tools. The clamp is wrapped around the pipe, properly positioned over the area to be repaired or connected, and the bolts tightened. This compacts the rubber gasket tightly against the full circumference of the pipe wall forming a leak resistant seal.

NOT JUST A REPAIR CLAMP

Full circle clamp couplings are often used as a coupling to join plain end pipe for new installations and pipe replacement programs.

ALL SIZES ALSO AVAILABLE IN TAPPED FULL CIRCLE CLAMP COUPLINGS!

| STEEL PIPE NOMINAL SIZE | OD RANGE INCHES | WIDTH INCHES | FIGURE NUMBER | PRICE |
|-------------------------|-----------------|--------------|---------------|-------|
| 1 1/4 | 1.66 | 7.5 | 7448 | |
| 1 1/2 | 1.88-1.92 | 7.5 | 7451 | |
| 2 | 2.35-2.63 | 7.5 | 7452 | |
| 2 1/2 | 2.70-3.00 | 7.5 | 7453 | |
| 3 | 2.97-3.25 | 7.5 | 7456 | |
| 3 1/2 | 3.96-4.25 | 7.5 | 22398 | |
| 4 | 4.45-4.73 | 10 | 7459 | |
| 5 | 5.22-5.62 | 10 | 7460 | |
| 6 | 6.56-6.96 | 10 | 7462 | |
| 8 | 8.54-8.94 | 10 | 7463 | |
| 10 | 10.64-11.04 | 10 | 7464 | |

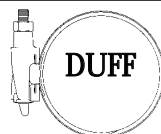

PIPE SCRAPERS

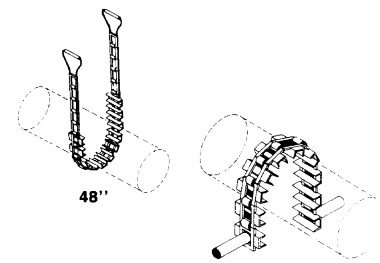

| LENGTH | FIG NO | PRICE |
|--------|----------|-------|
| 48" | DC230037 | |
| 22" | DC230038 | |

For additional information call: 610-275-4453 or Fax: 610-279-6299
Please call for current prices.

CLAMPS AND COUPLINGS



PIPE JOINT CLAMP - For stopping leaks at joints where pipe is screwed into a fitting. Quickly put on under pressure - without interruption of service. The Skinner Pipe Joint Clamp will withstand tremendous pressure. Saves the cost of tearing out and renewing leaky fittings. A positive repair not hindered by vibration or expansion. In use over 80 years on gas, oil, gasoline, steam, water, ammonia and brine leaks. The sliding push ring in the Skinner Pipe Joint Clamp transmits the pressure of the thrust screws to the gasket. The gasket, completely confined and guided by the lip on the face of the container ring, is forced directly into the threads, stopping the leak at its source. For temperatures over 300o, we can furnish clamps with silicone gaskets at additional an cost.

| | | | | | | | | | | |
|-----------------|-------|-------|-------|-------|-------|-------|-------|-------|-------|-------|
| SIZE | 1/2 | 3/4 | 1 | 1 1/4 | 1 1/2 | 2 | 2 1/2 | 3 | 3 1/2 | 4 |
| FIG. NO. | 40926 | 40927 | 40928 | 40930 | 40929 | 40931 | 40932 | 40933 | 40934 | 40935 |
| PRICE | | | | | | | | | | |

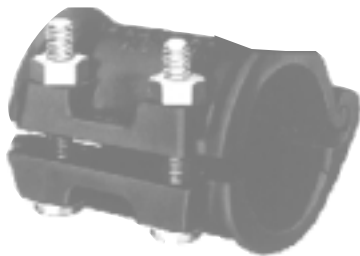

EMERGENCY CLAMP - For repairing pit holes, splits and corrosion leaks in both steel and cast iron pipe lines. Absolutely effective under extreme pressure or temperature. The universal repair clamp, the world over, for over three quarters of a century. Use on gas, water, steam, oil, ammonia, almost anything! The repair lasts for years. The emergency pipe clamp offers a triple economy. It saves: the cost of new pipe - the job of abandoning the old pipe and putting in the new - the expense of shutting down while work is being done, often thousands of dollars. It's no job at all to put on an emergency pipe clamp. Owing to the long open hinge, the two halves of the clamp may be

slid together along the pipe, when conditions are crowded. The clamp is usually put on under pressure - without interruption of service. Gasket, cemented into slight recess in bottom half, cannot "blow out". Bolts can be inserted from either side so that clamp can be installed easily under the most most awkward conditions. Made of malleable iron, strongly proportioned, and fitted with sturdy, electro-plated Iridite dipped steel bolts. Note the raised bosses for wrench convenience. All clamps painted to resist rust.

| | | | | | | | | | | |
|-----------------|-------|-------|-------|-------|-------|-------|-------|-------|-------|-------|
| SIZE | 1/2 | 3/4 | 1 | 1 1/4 | 1 1/2 | 2 | 2 1/2 | 3 | 3 1/2 | 4 |
| FIG. NO. | 40916 | 40917 | 40918 | 40919 | 40920 | 40921 | 40922 | 40923 | 40924 | 40925 |
| PRICE | | | | | | | | | | |

YES!
WE ACCEPT
VISA
AND
MASTERCARD!

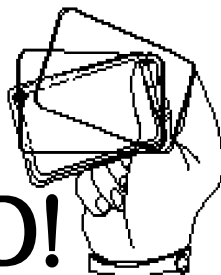

Don't forget to order bolts, nuts and gaskets with your flanges!

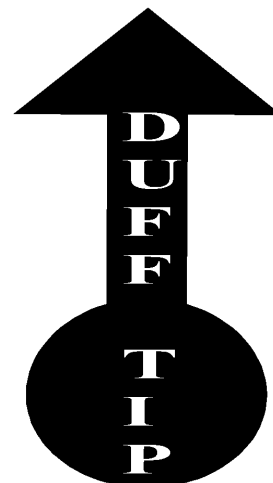

CORRUGATED STEEL PIPE AND PIPE ARCHES

PLAIN GALVANIZED



Plain galvanized pipe is fabricated or copper-bearing steel for maximum service life. This pipe meets the applicable requirements of both Federal and State Highway specifications.

| SIZE | PIPE | | COUPLING | |
|------|----------|-------|----------|-------|
| | FIG. NO. | PRICE | FIG. NO. | PRICE |
| 8 | 43685 | | 50743 | |
| 10 | 43686 | | 50744 | |
| 12 | 6192 | | 50745 | |
| 15 | 6194 | | 50746 | |
| 18 | 6195 | | 50747 | |
| 21 | 6196 | | 50748 | |
| 24 | 6197 | | 50749 | |
| 30 | 6198 | | 50750 | |
| 36 | 6199 | | 50751 | |

FULLY ASPHALT-COATED AND PAVED

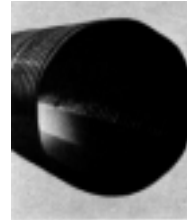

Designed for maximum service life where corrosion and wear are usually severe. The pipe is completely coated with asphalt, and is paved in the bottom quarter (90°)

CONVOLUTED (ARCHED) PIPE

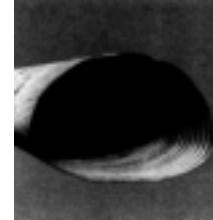

HALF ASPHALT-COATED AND PAVED



Recommended wherever corrosion or surface-wearing elements are factors. Lower half (180 deg.) of pipe is asphalt coated and a smooth paving in the bottom quarter (90 deg) completely covers the corrugations.

FULLY ASPHALT-COATED



Fully asphalt coated pipe is designed for installations where corrosive elements are present in the water or earth. This extra protection is also recommended where solids are waterborne.

| | | |
|---|---|---|
|  |  |  |
| VESSEL OPENINGS | | |
| MAN HOLE | HANDHOLE | CLOSURE |
| ALL AVAILABLE IMMEDIATELY! | | |

LEAK REPAIR PLUGS

| SIZE | FIG NO | PRICE |
|------|--------|-------|
| 3/8 | 20716 | |
| 1/2 | 20717 | |
| 5/8 | 20718 | |
| 3/4 | 20719 | |
| 1 | 20763 | |

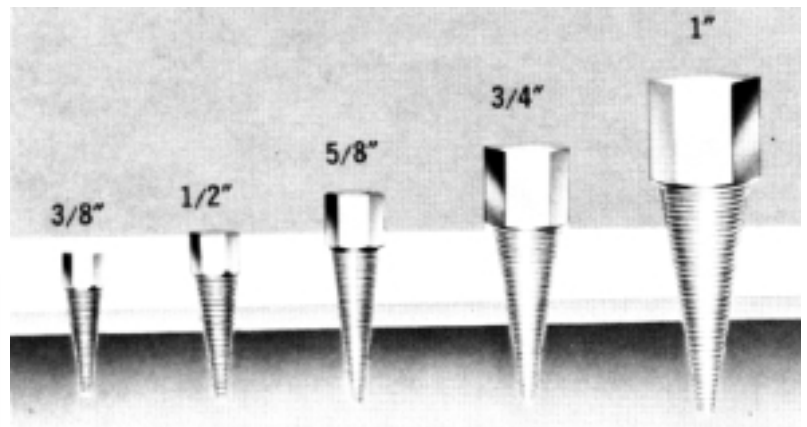

For additional information call: 610-275-4453 or Fax: 610-279-6299
Please call for current prices.

125 LB. CAST BRASS FITTINGS



90° Elbow 90° Street Elbow Side outlet 90° Elbow 45° Elbow 45° Street Elbow Tee Street Tee Cross

| SIZE | FIG NO | PRICE | FIG NO | PRICE | FIG NO | PRICE | FIG NO | PRICE | FIG NO | PRICE | FIG NO | PRICE | FIG NO | PRICE | FIG NO | PRICE |
|-------|--------|-------|--------|-------|--------|-------|--------|-------|--------|-------|--------|-------|--------|-------|--------|-------|
| 1/8 | 2259 | | 2284 | | - | | 2293 | | 2302 | | 2311 | | - | | 12126 | |
| 1/4 | 2260 | | 2285 | | - | | 2294 | | 2303 | | 2312 | | - | | 12128 | |
| 3/8 | 2261 | | 2286 | | - | | 2295 | | 2304 | | 2313 | | - | | 12129 | |
| 1/2 | 2262 | | 2287 | | - | | 2296 | | 2305 | | 2314 | | - | | 12131 | |
| 3/4 | 2263 | | 2288 | | - | | 2297 | | 2306 | | 2315 | | 31961 | | 12132 | |
| 1 | 2264 | | 2289 | | - | | 2298 | | 2307 | | 2316 | | 31959 | | 12133 | |
| 1 1/4 | 2265 | | 2290 | | 26372 | | 2299 | | 2308 | | 2317 | | 31962 | | 12134 | |
| 1 1/2 | 2266 | | 2291 | | - | | 2300 | | 2309 | | 2318 | | - | | 12136 | |
| 2 | 2267 | | 2292 | | - | | 2301 | | 2310 | | 2319 | | - | | 12138 | |
| 2 1/2 | 12069 | | 12083 | | - | | 12087 | | - | | 12090 | | 31964 | | 12139 | |
| 3 | 12071 | | 12084 | | - | | 12088 | | - | | 12091 | | - | | 12140 | |
| 3 1/2 | - | | - | | - | | - | | - | | 31925 | | - | | - | |
| 4 | 31899 | | - | | - | | 31913 | | - | | 31924 | | - | | - | |



Wye Coupling Union Cap Countersunk plug Brass Companion Flange Locknut Plug

| SIZE | FIG NO | PRICE | FIG NO | PRICE | FIG NO | PRICE | FIG NO | PRICE | FIG NO | PRICE | FIG NO | PRICE | FIG NO | PRICE | FIG NO | PRICE |
|-------|--------|-------|--------|-------|--------|-------|--------|-------|--------|-------|--------|-------|--------|-------|--------|-------|
| 1/8 | - | | 2332 | | 2364 | | 2373 | | 12156 | | 51740 | | 12169 | | 2382 | |
| 1/4 | - | | 2333 | | 2365 | | 2374 | | 12157 | | - | | 12170 | | 2383 | |
| 3/8 | 12144 | | 2334 | | 2366 | | 2375 | | 12158 | | - | | 12171 | | 2384 | |
| 1/2 | 12145 | | 2335 | | 2367 | | 2376 | | 12159 | | 12180 | | 12172 | | 2385 | |
| 3/4 | 12147 | | 2336 | | 2368 | | 2377 | | 12161 | | 12181 | | 12173 | | 2386 | |
| 1 | 12148 | | 2337 | | 2369 | | 2378 | | 12162 | | 12182 | | 12174 | | 2387 | |
| 1 1/4 | 12150 | | 2338 | | 2370 | | 2379 | | 12163 | | 12183 | | 12175 | | 2388 | |
| 1 1/2 | 12151 | | 2339 | | 2371 | | 2380 | | 12164 | | 12184 | | 12176 | | 2389 | |
| 2 | 12152 | | 2340 | | 2372 | | 2381 | | 12165 | | 12185 | | 12177 | | 2390 | |
| 2 1/2 | - | | 12098 | | 12105 | | 12111 | | 12166 | | 12186 | | 12178 | | 2391 | |
| 3 | - | | 12099 | | 12107 | | 5895 | | 12167 | | 12187 | | 12179 | | 12125 | |
| 3 1/2 | - | | - | | - | | - | | - | | - | | - | | - | |
| 4 | - | | 31967 | | 32042 | | 31977 | | 32045 | | 32044 | | 31991 | | 32038 | |

***CAST BRASS FITTINGS ALSO AVAILABLE IN EXTRA HEAVY (250LB)**

125 LB. CAST BRASS REDUCING FITTINGS

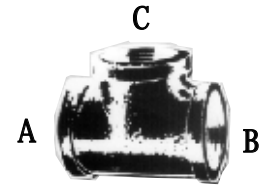

| SIZE | Bushing | | Face Bushing | | Reducing Coupling | | Reducing 90 | |
|-------------|----------|-------|--------------|-------|-------------------|-------|-------------|-------|
| | FIG. NO. | PRICE | FIG. NO. | PRICE | FIG. NO. | PRICE | FIG. NO. | PRICE |
| 1/4 1/8 | 2392 | | 32010 | | 2341 | | 2270 | |
| 3/8 1/8 | 2394 | | 32011 | | 2343 | | 2269 | |
| 3/8 1/4 | 2393 | | 32012 | | 2342 | | 2268 | |
| 1/2 1/8 | 2397 | | | | 2346 | | - | |
| 1/2 1/4 | | | 32014 | | 2345 | | 2272 | |
| 1/2 3/8 | 2395 | | 2422 | | 2344 | | 2271 | |
| 3/4 1/8 | 2401 | | - | | 2350 | | - | |
| 3/4 1/4 | 2400 | | 32015 | | 2349 | | 31901 | |
| 3/4 3/8 | 2399 | | 32016 | | 2348 | | 31902 | |
| 3/4 1/2 | 2398 | | 2423 | | 2347 | | 48559 | |
| 1 1/4 | 2405 | | | | 5891 | | 51715 | |
| 1 3/8 | 2404 | | | | 5890 | | 31903 | |
| 1 1/2 | 2403 | | | | 2352 | | 2275 | |
| 1 3/4 | 2402 | | 32020 | | 2351 | | 2274 | |
| 1 1/4 1/4 | 25419 | | - | | | | - | |
| 1 1/4 3/8 | 26328 | | - | | | | - | |
| 1 1/4 1/2 | 2408 | | | | 2355 | | 2278 | |
| 1 1/4 3/4 | 2407 | | | | 2354 | | 2277 | |
| 1 1/4 1 | 2406 | | | | 2353 | | 2276 | |
| 1 1/2 1/4 | 26327 | | - | | - | | - | |
| 1 1/2 3/8 | 26325 | | - | | - | | - | |
| 1 1/2 1/2 | 2412 | | | | 5894 | | - | |
| 1 1/2 3/4 | 2411 | | 32025 | | 2358 | | 12074 | |
| 1 1/2 1 | 2410 | | | | 2357 | | 2280 | |
| 1 1/2 1 1/4 | 2409 | | 32027 | | 2356 | | 2279 | |
| 2 1/4 | 31992 | | - | | - | | - | |
| 2 3/8 | 51734 | | - | | - | | - | |
| 2 1/2 | 2417 | | - | | 2363 | | 51716 | |
| 2 3/4 | 2416 | | | | 2362 | | 12078 | |
| 2 1 | 2415 | | | | 2361 | | - | |
| 2 1 1/4 | 2414 | | | | 2360 | | 2282 | |
| 2 1 1/2 | 2413 | | | | 2359 | | 2281 | |
| 2 1/2 1/2 | 31993 | | - | | - | | - | |
| 2 1/2 3/4 | 31994 | | - | | - | | - | |
| 2 1/2 1 | 31995 | | - | | - | | - | |
| 2 1/2 1 1/4 | 22913 | | - | | - | | - | |
| 2 1/2 1 1/2 | 2419 | | - | | 31969 | | 31904 | |
| 2 1/2 2 | 2418 | | - | | 12102 | | 31905 | |
| 3 1/2 | | | - | | - | | - | |
| 3 3/4 | | | - | | - | | - | |
| 3 1 | 26332 | | - | | - | | - | |
| 3 1 1/4 | 26330 | | - | | - | | - | |
| 3 1 1/2 | 26329 | | - | | 31970 | | - | |
| 3 2 | 2421 | | - | | 31971 | | - | |
| 3 2 1/2 | 2420 | | - | | 12103 | | 31907 | |

| REDUCING TEE | | | | |
|--------------|-------|-------|----------|-------|
| SIZE | | | FIG. NO. | PRICE |
| A | B | C | | |
| 1/8 | 1/8 | 1/4 | | |
| 1/4 | 1/4 | 1/8 | 5858 | |
| 3/8 | 3/8 | 1/4 | 5860 | |
| 1/2 | 1/2 | 1/4 | 2320 | |
| 1/2 | 1/2 | 3/8 | 2321 | |
| 1/2 | 1/2 | 3/4 | 26376 | |
| 1/2 | 1/2 | 1/2 | 10706 | |
| 3/4 | 1/2 | 3/4 | 2323 | |
| 3/4 | 3/4 | 1/4 | 21416 | |
| 3/4 | 3/4 | 3/8 | 23527 | |
| 3/4 | 3/4 | 1/2 | 2322 | |
| 3/4 | 3/4 | 1 | 26378 | |
| 3/4 | 1/2 | 1/2 | 5862 | |
| 1 | 1/2 | 3/4 | 2324 | |
| 1 | 1/2 | 1 | 2325 | |
| 1 | 3/4 | 3/4 | 5863 | |
| 1 | 3/4 | 1 | 20004 | |
| 1 | 1 | 3/8 | 21511 | |
| 1 | 1 | 1/2 | 5864 | |
| 1 | 1 | 3/4 | 2326 | |
| 1 | 1 | 1 1/4 | 26379 | |
| 1 | 1 | 1 1/2 | 26381 | |
| 1 | 3/4 | 3/4 | 5863 | |
| 1 1/4 | 3/4 | 1 1/4 | 2331 | |
| 1 1/4 | 1 1/4 | 1/2 | 2328 | |
| 1 1/4 | 1 1/4 | 3/4 | 2329 | |
| 1 1/4 | 1 1/4 | 1 | 2330 | |
| 1 1/4 | 1 1/4 | 1 1/2 | 26382 | |
| 1 1/4 | 1 1/4 | 1/2 | 5870 | |
| 1 1/2 | 1 1/2 | 3/4 | 5871 | |
| 1 1/2 | 1 1/2 | 1 | 5872 | |
| 1 1/2 | 1 1/2 | 1 1/4 | 5873 | |
| 1 1/2 | 1 1/2 | 1/2 | 5880 | |
| 2 | 2 | 3/4 | 5881 | |
| 2 | 2 | 1 | 5882 | |
| 2 | 2 | 1 1/4 | 5883 | |
| 2 | 2 | 1 1/2 | 5884 | |
| 2 1/2 | 2 1/2 | 1 | 31954 | |
| 2 1/2 | 2 1/2 | 1 1/4 | 31955 | |
| 2 1/2 | 2 1/2 | 1 1/2 | 31956 | |
| 2 1/2 | 2 1/2 | 2 | 12096 | |
| 3 | 3 | 2 1/2 | 12094 | |

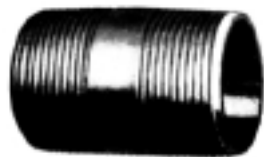

BRASS NIPPLES



| SIZE | 1/8 | | 1/4 | | 3/8 | | 1/2 | | 3/4 | |
|-------|--------|-------|--------|-------|--------|-------|--------|-------|--------|-------|
| | FIG NO | PRICE | FIG NO | PRICE | FIG NO | PRICE | FIG NO | PRICE | FIG NO | PRICE |
| Close | 2424 | | 2436 | | 2448 | | 2460 | | 2475 | |
| Sh. | 2425 | | 2437 | | 2449 | | 2461 | | 2476 | |
| 2 | 2426 | | 2438 | | 2450 | | 2462 | | 2477 | |
| 2 1/2 | 2427 | | 2439 | | 2451 | | 2463 | | 2478 | |
| 3 | 2428 | | 2440 | | 2452 | | 2464 | | 2479 | |
| 3 1/2 | 2429 | | 2441 | | 2453 | | 2465 | | 2480 | |
| 4 | 2430 | | 2442 | | 2454 | | 2466 | | 2481 | |
| 4 1/2 | 2431 | | 2443 | | 2455 | | 2467 | | 2482 | |
| 5 | 2432 | | 2444 | | 2456 | | 2468 | | 2483 | |
| 5 1/2 | 2433 | | 2445 | | 2457 | | 2469 | | 2484 | |
| 6 | 2434 | | 2446 | | 2458 | | 2470 | | 2485 | |
| 7 | 35746 | | 35752 | | 35757 | | 35763 | | 35700 | |
| 8 | 35747 | | 35753 | | 35758 | | 35764 | | 35701 | |
| 9 | 35748 | | 35754 | | 35759 | | 35765 | | 35702 | |
| 10 | 35749 | | 21196 | | 35760 | | 35766 | | 35703 | |
| 11 | 35750 | | 23348 | | 35761 | | 35767 | | 35704 | |
| 12 | 35751 | | 35755 | | 35762 | | 35768 | | 35705 | |

| SIZE | 1 | | 1 1/4 | | 1 1/2 | | 2 | | 2 1/2 | | 3 | |
|-------|--------|-------|--------|-------|--------|-------|--------|-------|--------|-------|--------|-------|
| | FIG NO | PRICE | FIG NO | PRICE | FIG NO | PRICE | FIG NO | PRICE | FIG NO | PRICE | FIG NO | PRICE |
| Close | 2487 | | 2498 | | 2509 | | 2520 | | 12363 | | 12376 | |
| Sh. | 2488 | | 2499 | | 2510 | | 2521 | | 12366 | | 12377 | |
| 2 | - | | - | | - | | - | | - | | - | |
| 2 1/2 | 2489 | | 2500 | | 2511 | | - | | - | | - | |
| 3 | 2490 | | 2501 | | 2512 | | 2522 | | - | | - | |
| 3 1/2 | 2491 | | 2502 | | 2513 | | 2523 | | 12367 | | 12378 | |
| 4 | 2492 | | 2503 | | 2514 | | 2524 | | 12369 | | 12379 | |
| 4 1/2 | 2493 | | 2504 | | 2515 | | 2525 | | 12371 | | 12380 | |
| 5 | 2494 | | 2505 | | 2516 | | 2526 | | 12372 | | 12381 | |
| 5 1/2 | 2495 | | 2506 | | 2517 | | 2527 | | 12373 | | 12382 | |
| 6 | 2496 | | 2507 | | 2518 | | 2528 | | 12374 | | 12383 | |
| 7 | 35709 | | 35715 | | 35721 | | 35726 | | 35733 | | 35739 | |
| 8 | 35710 | | 35716 | | 35722 | | 35727 | | 35734 | | 35740 | |
| 9 | 35711 | | 35717 | | 35723 | | 35728 | | 35735 | | 35741 | |
| 10 | 35712 | | 35718 | | 35724 | | 35729 | | 35736 | | 35742 | |
| 11 | 35713 | | 35719 | | 35725 | | 35730 | | 35737 | | 35743 | |
| 12 | 34722 | | 35720 | | 23715 | | 35731 | | 35738 | | 35744 | |

PACKING AND GASKET MATERIAL

NON-ASBESTOS PACKING



CONSTRUCTION: Multi-Lok Braid

FEATURES: Non-asbestos fibers treated with a specially formulated blend of lubricants.

RECOMMENDED FOR:

Steam, super heated steam, air petroleum products, hot gases.

LIMITATIONS: Maximum line temperature 1200

Sold by the pound.

| SIZE | FEET PER POUND | FIG. NO. | PRICE |
|------|----------------|----------|-------|
| 3/16 | 57 | 8213 | |
| 5/16 | 19 | 8219 | |
| 7/16 | 8.2 | 8224 | |
| 1/8 | 80 | 8210 | |
| 3/8 | 9.7 | 8220 | |
| 5/8 | 3.2 | 8230 | |
| 1/2 | 6.0 | 8228 | |
| 1/4 | 22 | 8217 | |
| 3/4 | 2.8 | 8237 | |

TEFLON PACKING

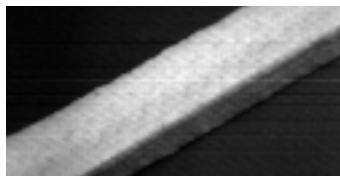

CONSTRUCTION: Multi-Lok Braid.

FEATURES: Yarns are coated in PTFE suspenoid. This system of impregnation assures even distribution of the PTFE. The fibers are saturated and sealed with the PTFE particles, protecting the fibers from chemical action.

SURFACE TREATMENT: A surface coating of PTFE is applied after braiding. To assure good break-in characteristics, a special high temperature synthetic lubricant is added.

EQUIPMENT: General service on rotary and reciprocating pumps, agitators.

RECOMMENDED FOR: Caustics, mild acids, difficult chemicals, air, gases, solvents, oils, general chemical plant applications.

LIMITATIONS: Shaft speeds to 1885; temperatures to 500°F 260°C; pH 3-11.

REMARKS: Our PTFE dispersion system provides greater penetration and more thorough dissemination of the insert PTFE.

| SIZE | FIG. NO. | PRICE |
|------|----------|-------|
| 1/8 | 8185 | |
| 1/4 | 8190 | |
| 3/16 | 8188 | |
| 5/16 | 8194 | |
| 3/8 | 8197 | |
| 7/16 | 8200 | |
| 1/2 | 8201 | |
| 5/8 | 8202 | |
| 3/4 | 8205 | |
| 1 | 8208 | |

For additional information call: 610-275-4453 or Fax: 610-279-6299
Please call for current prices.

**NEOPRENE AND CLOTH INSERTED
NEOPRENE SHEETS AVAILABLE!**

RED RUBBER SHEET



High grade red rubber compound. General purpose for water, air, etc. Standard width 36". Max temperature 375°F.

6 X 6 RED RUBBER SHEET

| FIG. NO. | PRICE |
|----------|-------|
| 44323 | |

PER SQUARE FOOT

| SIZE | FIG. NO. | @ WT PER SQ FT | PRICE |
|------|----------|----------------|-------|
| 1/16 | 8256 | 1/2 LB | |
| 3/32 | 8260 | 3/4 LB | |
| 1/8 | 8261 | 1 LB | |
| 1/4 | 8266 | 2 LB | |

ALSO AVAILABLE: GUM, BUNA, EPDM/BUTYL, TEFLON/SILICON

COMPRESSED NON-ASBESTOS SHEET



Selected long fiber non-asbestos mixed with a special heat and chemical resisting binder. Excellent for use against oil, steam, (saturated and superheated) acids, alkalies, etc. Standard sheet 60"x60". Max temp

700°F, Max pressure 400 PSI. **Sold by sheet or by the pound.**

BY 60" X 60" SHEET

| SIZE | FIG. NO. | PRICE |
|------|----------|-------|
| 1/64 | 40051 | |
| 1/32 | 40052 | |
| 1/16 | 40053 | |
| 1/8 | 40054 | |
| 1/4 | 40055 | |
| 3/32 | 47227 | |

2000# FORGED STEEL THREADED FITTINGS

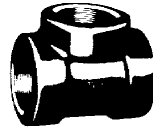

| SIZE | 90° ELBOW | | 45° ELBOW | | TEE | | CROSS | |
|-------|-----------|-------|-----------|-------|----------|-------|----------|-------|
| | FIG. NO. | PRICE | FIG. NO. | PRICE | FIG. NO. | PRICE | FIG. NO. | PRICE |
| 1/4 | 5109 | | 5125 | | 5117 | | 5133 | |
| 3/8 | 5110 | | 5126 | | 5118 | | 5134 | |
| 1/2 | 5111 | | 5127 | | 5119 | | 5135 | |
| 3/4 | 5112 | | 5128 | | 5120 | | 5136 | |
| 1 | 5113 | | 5129 | | 5121 | | 5137 | |
| 1 1/4 | 5114 | | 5130 | | 5122 | | 5138 | |
| 1 1/2 | 5115 | | 5131 | | 5123 | | 5139 | |
| 2 | 5116 | | 5132 | | 5124 | | 5140 | |
| 2 1/2 | 20449 | | 32223 | | 31280 | | 32226 | |
| 3 | 32219 | | 32224 | | 32221 | | 32227 | |
| 4 | 32220 | | 32225 | | 32222 | | 32228 | |

3000# FORGED STEEL THREADED AND SOCKET WELD FITTINGS



| SIZE | 90° Elbow | | 45° Elbow | | 90° Street Elbow | | TEE | |
|-------|-----------|--------|-----------|--------|------------------|--------|----------|-------|
| | THREAD | SOCKET | THREAD | SOCKET | THREAD | THREAD | SOCKET | |
| | FIG. NO. | PRICE | FIG. NO. | PRICE | FIG. NO. | PRICE | FIG. NO. | PRICE |
| 1/8 | 5141 | 5324 | 5160 | 5722 | 5170 | 5151 | 5693 | |
| 1/4 | 17582 | 5325 | 5161 | 5724 | 5171 | 5152 | 5696 | |
| 3/8 | 5144 | 5326 | 5162 | 5727 | 5172 | 5153 | 5700 | |
| 1/2 | 5145 | 5680 | 5163 | 5730 | 5173 | 5154 | 5702 | |
| 3/4 | 5146 | 5681 | 5164 | 5733 | 5174 | 5155 | 5706 | |
| 1 | 5147 | 5682 | 5165 | 5735 | 5175 | 5156 | 5710 | |
| 1 1/4 | 5148 | 5685 | 5167 | 5738 | 5176 | 5157 | 5713 | |
| 1 1/2 | 5149 | 5687 | 5168 | 5740 | 5177 | 5158 | 5715 | |
| 2 | 5150 | 5690 | 5169 | 5743 | 5178 | 5159 | 5718 | |
| 2 1/2 | 32235 | 32262 | 32243 | 32269 | - | 32239 | 32266 | |
| 3 | 32237 | 32264 | 32244 | 32270 | - | 32241 | 32267 | |
| 4 | 32238 | 32265 | 32245 | 32271 | - | 32242 | 32268 | |



| SIZE | CROSS | | WYE | | UNION | | |
|----------|--------|----------|--------|----------|--------|----------|-------|
| | THREAD | SOCKET | THREAD | SOCKET | THREAD | SOCKET | |
| FIG. NO. | PRICE | FIG. NO. | PRICE | FIG. NO. | PRICE | FIG. NO. | PRICE |
| 1/8 | 5180 | | | | 40024 | - | |
| 1/4 | 5181 | | | | 5301 | 5780 | |
| 3/8 | 5182 | | | | 5302 | 5781 | |
| 1/2 | 5185 | | | | 5305 | 5782 | |
| 3/4 | 5186 | | | | 5309 | 5783 | |
| 1 | 5187 | | | | 5313 | 5784 | |
| 1 1/4 | 5188 | | | | 5316 | 5785 | |
| 1 1/2 | 5189 | | | | 5320 | 5786 | |
| 2 | 5190 | | | | 5323 | 5787 | |
| 2 1/2 | 32246 | | | | 26492 | 32278 | |
| 3 | 32247 | | | | 26494 | 32279 | |
| 4 | 32248 | | | | 32255 | 32280 | |

3000 FORGED STEEL FITTINGS



COUPLING



HALF COUPLING



CAP



PLUG

| SIZE | COUPLING | | HALF COUPLING | | CAP | | PLUG | |
|-------|----------|-------|---------------|-------|-------|-------|------|-------|
| | FIG. | PRICE | FIG. | PRICE | FIG. | PRICE | FIG. | PRICE |
| 1/8 | 5191 | 5750 | 23769 | 5201 | 5767 | 5211 | | |
| 1/4 | 5192 | 5753 | 23770 | 5202 | 5770 | 5212 | | |
| 3/8 | 5193 | 5754 | 23771 | 5203 | 5771 | 5213 | | |
| 1/2 | 5194 | 5755 | 20326 | 5205 | 5772 | 5214 | | |
| 3/4 | 5196 | 5756 | 20327 | 5206 | 5773 | 5215 | | |
| 1 | 5197 | 5758 | 23772 | 5207 | 5774 | 5216 | | |
| 1 1/4 | 5198 | 5759 | 23773 | 5208 | 5776 | 5217 | | |
| 1 1/2 | 5199 | 5762 | 20328 | 5209 | 5778 | 5218 | | |
| 2 | 5200 | 5765 | 20452 | 5210 | 5779 | 5219 | | |
| 2 1/2 | 25181 | 32272 | 26487 | 32249 | 32275 | 32252 | | |
| 3 | 26484 | 32273 | 26489 | 32250 | 32276 | 32253 | | |
| 4 | 26485 | 32274 | 26491 | 32251 | 32277 | 32254 | | |

BUSHING (THREADED)

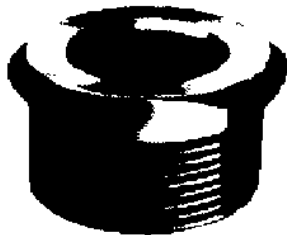

REDUCER INSERT

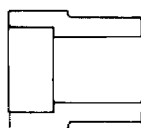

Use to make reducing fittings.
All sizes available.

| SIZE | FIG. | PRICE | SIZE | FIG. | PRICE |
|-------|-------|-------|-------|-------|-------|
| 1/4 | 1/8 | 5221 | 2 | 1/8 | 5298 |
| 3/8 | 1/8 | 5223 | | 1/4 | 5295 |
| | 1/4 | 5222 | | 3/8 | 5291 |
| 1/2 | 1/8 | 5226 | | 1/2 | 5288 |
| | 1/4 | 5225 | | 3/4 | 5286 |
| | 3/8 | 5224 | | 1 | 5285 |
| 3/4 | 1/8 | 5230 | | 1 1/4 | 5282 |
| | 1/4 | 5229 | | 1 1/2 | 5278 |
| | 3/8 | 5228 | 2 1/2 | 1/2 | 26472 |
| | 1/2 | 5227 | | 3/4 | 26470 |
| 1 | 1/8 | 5236 | | 1 | 26464 |
| | 1/4 | 5235 | | 1 1/4 | 26462 |
| | 3/8 | 5233 | | 1 1/2 | 26461 |
| | 1/2 | 5232 | | 2 | 26460 |
| | 3/4 | 5231 | 3 | 1 | 26481 |
| 1 1/4 | 1/8 | 5260 | | 1 1/4 | 26480 |
| | 1/4 | 5253 | | 1 1/2 | 26477 |
| | 3/8 | 5247 | | 2 | 26476 |
| | 1/2 | 5242 | | 2 1/2 | 26474 |
| | 3/4 | 5239 | 4 | 1 | 32261 |
| | 1 | 5237 | | 1 1/4 | 32260 |
| 1 1/2 | 1/8 | 5275 | | 1 1/2 | 32259 |
| | 1/4 | 5272 | | 2 | 32258 |
| | 3/8 | 5269 | | 2 1/2 | 32257 |
| | 1/2 | 5267 | | 3 | 32256 |
| | 3/4 | 5265 | | | |
| | 1 | 5262 | | | |
| | 1 1/4 | 5261 | | | |

6000# THREADED AND SOCKET
WELD FLANGES ALWAYS AVAILABLE!

SELECTION AND APPLICATION OF FORGED STEEL FLANGES

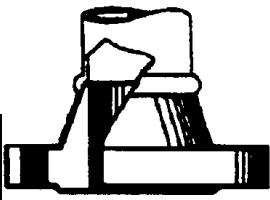

Welding Neck Flanges are distinguished from other types by their long tapered hub and gentle transition of thickness in the region of the butt weld joining them to the pipe. The long tapered hub provides an important reinforcement of the flange proper from the standpoint of strength and resistance to dishing. The smooth transition from flange thickness to pipe wall thickness effected by the taper is extremely beneficial under conditions of repeated bending, caused by line expansion or other variable forces, and produces an endurance strength of welding neck flanged assemblies equivalent to that of a butt welded joint between pipes, which, in practice, is the same as that of unwelded pipe. Thus this type of flange is preferred for every severe service condition, whether this results from high pressure or from sub-zero or elevated temperature, and whether loading conditions are substantially constant or fluctuate between wide limits; welding neck flanges are particularly recommended for handling explosive, flammable or costly liquids, where loss of tightness or local failure may be accompanied by disastrous consequences.

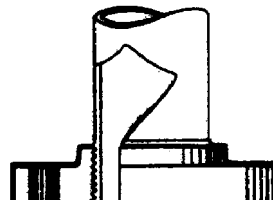

Screwed Flanges made of steel are confined to special applications. Their chief merit lies in the fact that they can be assembled without welding; this explains their use in extremely high pressure services, particularly at or near atmospheric temperature, where alloy steel is essential for strength and where the necessary post-weld heat treatment is impractical. Screwed flanges are unsuited for conditions involving temperature or bending stresses of any magnitude, particularly under cyclic conditions, where leakage through the threads may occur in relatively few cycles of heating or stress; seal welding is sometimes employed to overcome this, but cannot be considered as entirely satisfactory.

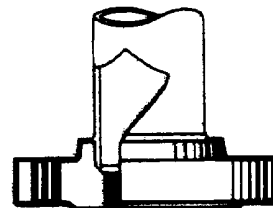

Socket Welding Flanges were initially developed for use on small-size high pressure piping. Their initial cost is about 10% greater than that of slip-on flanges; when provided with an internal weld as illustrated, their static strength is equal to, but their fatigue strength 50% greater than double-welded slip-on flanges. Smooth, pocketless bore conditions can readily be attained (by grinding the internal weld) without having to bevel the flange face and, after welding, to reface the flange as would be required with slip-on flanges. The internally welded socket type flange is becoming increasingly popular in chemical process piping for this reason.

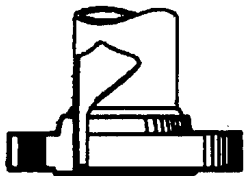

Slip-On Flanges continue to be preferred to welding neck flanges by many users on account of their initially lower cost, the reduced accuracy required in cutting the pipe to length, and the somewhat greater ease by alignment of the assembly; however, their final installed cost is probably not much, if any, less than that of welding neck flanges. Their calculated strength under internal pressure is of the order of two-thirds that of welding neck flanges, and their life under fatigue is about one-third that of the latter. For these reasons, slip-on flanges are limited to sized NPS 1/2 to 2 1/2 in the 1500 standard.

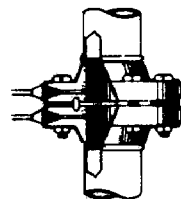

Orifice Flanges are widely used in conjunction with orifice meters for measuring the rate of flow of liquids and gases. They are basically the same as standard welding neck, slip-on and screwed flanges except for the provision of radial, tapped holes in the flange ring for meter connections and additional bolts to act as jack screws to facilitate separating the flanges for inspection or replacement of the orifice plate. In choosing the type of orifice flange, the considerations affecting the choice of welding neck, slip-on and screwed standard flanges apply with equal force.

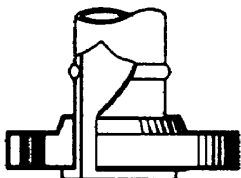

Lap Joint Flanges are primarily employed with lap joint stubs, the combined initial cost of the two items being approximately one-third higher than that of comparable welding neck flanges. Their pressure-holding ability is little, if any, better than that of slip-on flanges and the fatigue life for the assembly is only one-tenth that of welding neck flanges. The chief use of lap joint flanges in carbon or low alloy steel piping systems is in services necessitating frequent dismantling for inspection and cleaning and where the ability to swivel flanges and to align bolt holes materially simplifies the erection of large diameter of unusually stiff piping. Their use at points where severe bending stress occurs should be avoided.

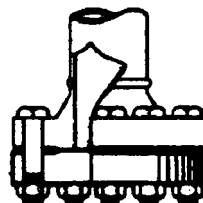

Blind Flanges are used to blank off the ends of piping, valves and pressure vessel openings. From the standpoint of internal pressure and bolt loading, blind flanges, particularly in the larger sizes, are the most highly stressed of all American Standard flange types. However, since the maximum stressed in a blind flange are bending stresses at the center, they can safely be permitted to be higher than in other types of flanges. Where temperature is a service factor, or repeated severe water hammer, consideration should be given to closures made of welding neck flanges and caps.

CARBON STEEL WELDING FLANGES

Lap Joint and Socket Weld Flanges available for Immediate Delivery!



| SIZE | 150 # | | 300 # | | 150# | | 300# | | 150# LAP | |
|-------|---------|---------|----------|-------|----------|-------|----------|-------|----------|-------|
| | 150# OD | 300# OD | FIG. NO. | PRICE | FIG. NO. | PRICE | FIG. NO. | PRICE | FIG. NO. | PRICE |
| 1/2 | 3 1/2 | 3 3/4 | 6409 | | 6796 | | 6448 | | 6806 | 52053 |
| 3/4 | 3 7/8 | 4 5/8 | 6414 | | 6797 | | 6452 | | 6807 | 52054 |
| 1 | 4 1/4 | 4 7/8 | 6417 | | 6798 | | 6456 | | 6808 | 52055 |
| 1 1/4 | 4 5/8 | 5 1/4 | 6424 | | 6799 | | 6457 | | 6809 | 52056 |
| 1 1/2 | 5 | 6 1/8 | 6429 | | 6800 | | 6463 | | 6810 | 52057 |
| 2 | 6 | 6 1/2 | 6431 | | 6801 | | 6466 | | 6811 | 52058 |
| 2 1/2 | 7 | 7 1/2 | 6433 | | 6802 | | 6468 | | 6812 | 52059 |
| 3 | 7 1/2 | 8 1/4 | 6437 | | 6803 | | 6472 | | 6813 | 52060 |
| 3 1/2 | 8 1/2 | 9 | 6440 | | - | | 6475 | | - | - |
| 4 | 9 | 10 | 6442 | | 6804 | | 6477 | | 6814 | 65383 |
| 5 | 10 | 11 | 6443 | | - | | 6482 | | 52076 | 65384 |
| 6 | 11 | 12/12 | 6444 | | 6805 | | 6485 | | 6815 | 65385 |
| 8 | 13 1/2 | 15 | 6446 | | 52062 | | 6490 | | 61943 | - |
| 10 | 16 | 17 1/2 | 6447 | | - | | 6494 | | - | 52061 |
| 12 | 19 | 20 1/2 | 19795 | | - | | 19796 | | - | - |

Reducing Slip-on and threaded flanges, special bores, and Classes 400, 600, 900, 1500, and 2500 flanges available in all sizes at all times.



THREADED



BLIND



| SIZE | 150 # | | 300 # | | 150# | | 300# | |
|-------|---------|---------|----------|-------|----------|-------|----------|-------|
| | 150# OD | 300# OD | FIG. NO. | PRICE | FIG. NO. | PRICE | FIG. NO. | PRICE |
| 1/2 | 3 1/2 | 3 3/4 | 6498 | | 6816 | | 6542 | 6826 |
| 3/4 | 3 7/8 | 4 5/8 | 6501 | | 6817 | | 6548 | 6827 |
| 1 | 4 1/4 | 4 7/8 | 6506 | | 6818 | | 6550 | 6828 |
| 1 1/4 | 4 5/8 | 5 1/4 | 6510 | | 6819 | | 6554 | 6829 |
| 1 1/2 | 5 | 6 1/8 | 6514 | | 6820 | | 6560 | 6830 |
| 2 | 6 | 6 1/2 | 6516 | | 6821 | | 6565 | 6831 |
| 2 1/2 | 7 | 7 1/2 | 6522 | | 6822 | | 6570 | 6832 |
| 3 | 7 1/2 | 8 1/4 | 6525 | | 6823 | | 6573 | 6833 |
| 3 1/2 | 8 1/2 | 9 | - | | - | | 6576 | - |
| 4 | 9 | 10 | 6528 | | 6824 | | 6580 | 6834 |
| 5 | 10 | 11 | 6532 | | - | | 6583 | - |
| 6 | 11 | 12/12 | 6535 | | 6825 | | 6595 | 6835 |
| 8 | 13 1/2 | 15 | 6536 | | - | | 6603 | - |
| 10 | 16 | 17 1/2 | 6539 | | - | | 6608 | - |
| 12 | 19 | 20 1/2 | - | | - | | - | - |

CARBON STEEL WELD FITTINGS



90° Long Radius Elbow



90° Short Radius Elbow



45° Long Radius Elbow



Tee

| SIZE | STANDARD | | EXTRA HEAVY | | STANDARD | | EXTRA HEAVY | | STANDARD | | EXTRA HEAVY | | |
|-------|----------|-------|-------------|-------|----------|-------|-------------|-------|----------|-------|-------------|-------|-------|
| | FIG. NO. | PRICE | FIG. NO. | PRICE | FIG. NO. | PRICE | FIG. NO. | PRICE | FIG. NO. | PRICE | FIG. NO. | PRICE | |
| 1/2 | 5788 | | 6613 | | - | | 6058 | | 6650 | | 6090 | | 6679 |
| 3/4 | 5791 | | 6619 | | - | | 6059 | | 6653 | | 6093 | | 6681 |
| 1 | 5794 | | 6622 | | 6026 | | 6060 | | 6657 | | 6099 | | 6683 |
| 1 1/4 | 5797 | | 6628 | | 6029 | | 6061 | | 6660 | | 6100 | | 6686 |
| 1 1/2 | 5799 | | 6631 | | 6033 | | 6062 | | 6663 | | 6104 | | 6688 |
| 2 | 5836 | | 6634 | | 6036 | | 6063 | | 6664 | | 6110 | | 6691 |
| 2 1/2 | 5855 | | 6638 | | 6039 | | 6064 | | 6667 | | 6115 | | 6693 |
| 3 | 5904 | | 6641 | | 6041 | | 6066 | | 6670 | | 6120 | | 6696 |
| 3 1/2 | 5999 | | 6645 | | 6044 | | 6067 | | 6673 | | 6124 | | - |
| 4 | 6001 | | 6647 | | 6045 | | 6077 | | 6676 | | 6126 | | 6698 |
| 5 | 6006 | | - | | 6048 | | 6078 | | - | | 6130 | | - |
| 6 | 6009 | | - | | 6050 | | 6080 | | 52079 | | 6134 | | 52108 |
| 8 | 6012 | | - | | 6053 | | 6083 | | 52067 | | 6136 | | - |
| 10 | 6014 | | - | | 6056 | | 6086 | | 52100 | | 6138 | | - |
| 12 | 19797 | | - | | 19799 | | - | | - | | - | | - |
| 14 | 19798 | | - | | 19800 | | - | | - | | - | | - |



Cap



Cross



180° Long Return Bend



Lap Joint Stub End

| SIZE | STANDARD | | EXTRA HEAVY | | STANDARD | | STANDARD | | STANDARD | |
|-------|----------|-------|-------------|-------|----------|-------|----------|-------|----------|-------|
| | FIG. NO. | PRICE | FIG. NO. | PRICE | FIG. NO. | PRICE | FIG. NO. | PRICE | FIG. NO. | PRICE |
| 1/2 | 6140 | | 6702 | | - | | 28546 | | - | |
| 3/4 | 6143 | | 6705 | | - | | 28547 | | - | |
| 1 | 6146 | | 6708 | | - | | 28548 | | 28507 | |
| 1 1/4 | 6148 | | 6789 | | 28520 | | 28549 | | 28508 | |
| 1 1/2 | 6152 | | 6790 | | 28521 | | 28550 | | 28509 | |
| 2 | 6155 | | 6791 | | 28522 | | 28551 | | 28510 | |
| 2 1/2 | 6158 | | 6792 | | 28523 | | 28552 | | 28511 | |
| 3 | 6162 | | 6793 | | 28524 | | 28553 | | 28513 | |
| 3 1/2 | 6165 | | 6794 | | - | | 28554 | | - | |
| 4 | 6168 | | 6795 | | 28525 | | 28555 | | 28514 | |
| 5 | 6171 | | - | | 28525 | | 28556 | | - | |
| 6 | 6173 | | - | | 28526 | | 28559 | | 28515 | |
| 8 | 6177 | | - | | 28527 | | 28560 | | 28516 | |
| 10 | 6178 | | - | | 28528 | | 28561 | | 28517 | |
| 12 | 22076 | | - | | - | | 28562 | | 28518 | |
| 14 | 28506 | | - | | - | | - | | - | |

CARBON STEEL WELDING FITTINGS AND FLANGES



Concentric Reducer

Reducing 90 Elbow

| SIZE | FIG. | PRICE | FIG. | PRICE |
|-------|-------|-------|-------|-------|
| 2 | 1 1/4 | 6280 | 28479 | |
| | 1 1/2 | 6283 | 28480 | |
| 2 1/2 | 1 1/4 | 6290 | 28481 | |
| | 1 1/2 | 6292 | 28482 | |
| 3 | 2 | 6295 | 28483 | |
| | 1 1/2 | 6308 | 28484 | |
| | 2 | 6312 | 28485 | |
| 3 1/2 | 2 1/2 | 6316 | 28486 | |
| | 2 | 28532 | 28487 | |
| | 2 1/2 | 28533 | 28489 | |
| 4 | 3 | 28534 | 28490 | |
| | 2 | 6333 | 28491 | |
| | 2 1/2 | 6336 | 28492 | |
| 5 | 3 | 6339 | 28493 | |
| | 3 1/2 | 6343 | 28494 | |
| | 2 1/2 | 28536 | 28495 | |
| 6 | 3 | 28537 | 28496 | |
| | 3 1/2 | 28538 | 28497 | |
| | 4 | 28539 | 28498 | |
| 8 | 3 | 6366 | 28499 | |
| | 3 1/2 | 6370 | 28500 | |
| | 4 | 6376 | 28501 | |
| 8 | 5 | 6379 | 28502 | |
| | 4 | 6391 | 28503 | |
| | 5 | 6393 | 28504 | |
| | 6 | 6395 | 28505 | |

ALSO AVAILABLE FOR QUICK DELIVERY!



LATERALS



REDUCING TEES



SADDLES



WELDING RINGS

WELDOLETS & THREADOLETS

Used for making relatively small branch outlet connections. Easy to install -- provide 100% pipe strength and full fluid flow.

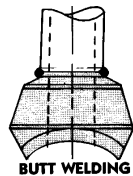

BUTT WELDING

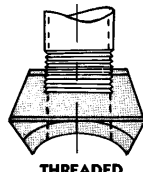

THREADED

| Size | Weld-O-Let | | Thread-O-Let | |
|-------|------------|-------|--------------|-------|
| | Fig No | Price | Fig No | Price |
| 1/8 | 18077 | | 18090 | |
| 1/4 | 18078 | | 18091 | |
| 3/8 | 18079 | | 18092 | |
| 1/2 | 18080 | | 18093 | |
| 3/4 | 18081 | | 18094 | |
| 1 | 18082 | | 18095 | |
| 1 1/4 | 18083 | | 18096 | |
| 1 1/2 | 18084 | | 18097 | |
| 2 | 18085 | | 18098 | |
| 2 1/2 | 18086 | | 18099 | |
| 3 | 18087 | | 18100 | |
| 3 1/2 | 18088 | | - | |
| 4 | 18089 | | 18101 | |

PHOENIX FLANGES

The perfect item for making outlets on plate or vessels.

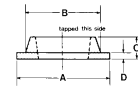
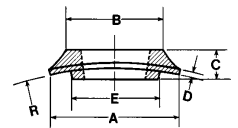
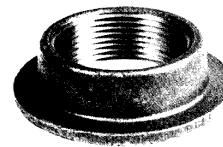

Standard-Tapped from hub side

Without Pilot

With Pilot

| Size | Fig No | Price | Fig No | Price |
|-------|--------|-------|--------|-------|
| 1/8 | 38802 | | - | |
| 1/4 | 38803 | | - | |
| 3/8 | 38804 | | - | |
| 1/2 | 38805 | | - | |
| 3/4 | 38806 | | 38813 | |
| 1 | 38807 | | 38814 | |
| 1 1/4 | 38809 | | 38815 | |
| 1 1/2 | 38808 | | 38816 | |
| 2 | 38810 | | 38817 | |
| 2 1/2 | - | | 41041 | |

For additional information call: 610-275-4453 or Fax: 610-279-6299
Please call for current prices.

RAILING FITTINGS SLIP-ON TYPE



#30 90° ELBOW

| Size | Fig No | Price |
|-------|--------|-------|
| 3/4 | 6065 | |
| 1 | 6068 | |
| 1 1/4 | 6070 | |
| 1 1/2 | 6072 | |

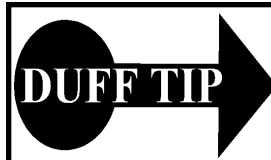

For use with Steel or Aluminum Pipe



#32 TEE

| Size | Fig No | Price |
|-------|--------|-------|
| 3/4 | 6082 | |
| 1 | 6084 | |
| 1 1/4 | 6085 | |
| 1 1/2 | 6087 | |



#37 3-WAY RACK FITTING

| Size | Fig No | Price |
|-------|--------|-------|
| 3/4 | - | - |
| 1 | 6116 | |
| 1 1/4 | 6117 | |
| 1 1/2 | 6118 | |

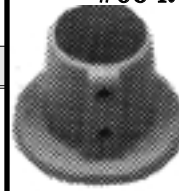

#95 ROUND FLANGE

| Size | Fig No | Price |
|-------|--------|-------|
| 3/4 | 6166 | |
| 1 | 6167 | |
| 1 1/4 | 6169 | |
| 1 1/2 | 6170 | |



#34 CROSS

| Size | Fig No | Price |
|-------|--------|-------|
| 3/4 | 6094 | |
| 1 | 6095 | |
| 1 1/4 | 6096 | |
| 1 1/2 | 6098 | |



#36 OFFSET FITTING

| Size | Fig No | Price |
|-------|--------|-------|
| 3/4 | 6106 | |
| 1 | 6108 | |
| 1 1/4 | 6109 | |
| 1 1/2 | 6111 | |



#90 ADJ. FLANGE

| Size | Fig No | Price |
|-------|--------|-------|
| 3/4 | 6137 | |
| 1 | 6139 | |
| 1 1/4 | 6141 | |
| 1 1/2 | 6142 | |



#31 SIDE OUTLET ELBOW

| Size | Fig No | Price |
|-------|--------|-------|
| 3/4 | 6074 | |
| 1 | 6076 | |
| 1 1/4 | 6079 | |
| 1 1/2 | 6081 | |



#8 RAIL CAP

| Size | Fig No | Price |
|-------|--------|-------|
| 3/4 | 6172 | |
| 1 | 6174 | |
| 1 1/4 | 6175 | |
| 1 1/2 | 6176 | |



#55 SWIVEL

| Size | Fig No | Price |
|-------|--------|-------|
| 3/4 | 6154 | |
| 1 | 6156 | |
| 1 1/4 | 6157 | |
| 1 1/2 | 6159 | |



#33 SIDE OUTLET TEE

| Size | Fig No | Price |
|-------|--------|-------|
| 3/4 | 6088 | |
| 1 | 6089 | |
| 1 1/4 | 6091 | |
| 1 1/2 | 6092 | |



#65 COUPLINGS

| Size | Fig No | Price |
|-------|--------|-------|
| 3/4 | 6160 | |
| 1 | 6161 | |
| 1 1/4 | 6163 | |
| 1 1/2 | 6164 | |



#40 ELBOW OR TEE

| Size | Fig No | Price |
|-------|--------|-------|
| 3/4 | 6119 | |
| 1 | 6121 | |
| 1 1/4 | 6122 | |
| 1 1/2 | 6123 | |



#35 SIDE OUTLET CROSS

| Size | Fig No | Price |
|-------|--------|-------|
| 3/4 | 6101 | |
| 1 | 6102 | |
| 1 1/4 | 6103 | |
| 1 1/2 | 6105 | |



#25 SIDE MOUNT FLANGE

| Size | Fig No | Price |
|-------|--------|-------|
| 3/4 | - | - |
| 1 | 6149 | |
| 1 1/4 | 6151 | |
| 1 1/2 | 6153 | |



#42 ADJUSTABLE TEE

| Size | Fig No | Price |
|-------|--------|-------|
| 3/4 | 6131 | |
| 1 | 6132 | |
| 1 1/4 | 6133 | |
| 1 1/2 | 6135 | |



#26 CORNER OR RACK FITTING

| Size | Fig No | Price |
|-------|--------|-------|
| 3/4 | - | - |
| 1 | 6112 | |
| 1 1/4 | 6113 | |
| 1 1/2 | 6114 | |



#24 FLANGE

| Size | Fig No | Price |
|-------|--------|-------|
| 3/4 | - | - |
| 1 | 6144 | |
| 1 1/4 | 6145 | |



#41 SIDE OUTLET ELL OR TEE

| Size | Fig No | Price |
|-------|--------|-------|
| 3/4 | 6125 | |
| 1 | 6127 | |
| 1 1/4 | 6128 | |

304 STAINLESS STEEL NIPPLES

| | 1/8 | | 1/4 | | 3/8 | | 1/2 | | 3/4 | | 1 | | 1 1/4 | | 1 1/2 | | 2 | |
|-------|----------|-------|----------|-------|----------|-------|----------|-------|----------|-------|----------|-------|----------|-------|----------|-------|----------|-------|
| SIZE | FIG. NO. | PRICE | FIG. NO. | PRICE | FIG. NO. | PRICE | FIG. NO. | PRICE | FIG. NO. | PRICE | FIG. NO. | PRICE | FIG. NO. | PRICE | FIG. NO. | PRICE | FIG. NO. | PRICE |
| CL | 6239 | | 6269 | | 6296 | | 6329 | | 6372 | | 6408 | | 6432 | | 17578 | | 17579 | |
| 1 1/2 | 6241 | | 17559 | | 6298 | | 6335 | | 6374 | | - | | - | | - | | - | |
| 2 | 6243 | | 6273 | | 6301 | | 6338 | | 17577 | | 17562 | | 6434 | | 6467 | | - | |
| 2 1/2 | 17560 | | 6274 | | 17575 | | 6341 | | 6381 | | 17563 | | 6435 | | 6470 | | 6499 | |
| 3 | 6249 | | 6276 | | 6309 | | 17561 | | 6383 | | 6416 | | 6436 | | 6473 | | 6504 | |
| 3 1/2 | 6251 | | 6278 | | 6313 | | 6348 | | 6386 | | 6419 | | 6438 | | 6474 | | 6507 | |
| 4 | 6253 | | 6281 | | 6315 | | 17576 | | 6389 | | 6420 | | 6439 | | 6478 | | 6512 | |
| 4 1/2 | 6260 | | 6285 | | 6319 | | 6358 | | 6396 | | 6423 | | 6451 | | 6483 | | 6515 | |
| 5 | 6262 | | 6286 | | 6320 | | 6364 | | 6400 | | 6426 | | 6455 | | 6487 | | 6518 | |
| 5 1/2 | 6265 | | 6289 | | 6325 | | 6368 | | 6403 | | 6427 | | 6459 | | 6491 | | 6523 | |
| 6 | 6267 | | 6294 | | 6328 | | 6369 | | 6407 | | 6430 | | 17564 | | 6493 | | 6527 | |

316 STAINLESS STEEL NIPPLES

| | 1/8 | | 1/4 | | 3/8 | | 1/2 | | 3/4 | | 1 | | 1 1/4 | | 1 1/2 | | 2 | |
|-------|----------|-------|----------|-------|----------|-------|----------|-------|----------|-------|----------|-------|----------|-------|----------|-------|----------|-------|
| SIZE | FIG. NO. | PRICE | FIG. NO. | PRICE | FIG. NO. | PRICE | FIG. NO. | PRICE | FIG. NO. | PRICE | FIG. NO. | PRICE | FIG. NO. | PRICE | FIG. NO. | PRICE | FIG. NO. | PRICE |
| CL | 36310 | | 36321 | | 36332 | | 36343 | | 36354 | | 36365 | | 36375 | | 36385 | | 36395 | |
| SH | 36311 | | 36322 | | 36333 | | 36344 | | 36355 | | 36366 | | 36376 | | 36386 | | 36396 | |
| 1 1/2 | - | | - | | - | | - | | - | | - | | - | | - | | - | |
| 2 | 36312 | | 36323 | | 36334 | | 36345 | | 36356 | | - | | - | | - | | - | |
| 2 1/2 | 36313 | | 36324 | | 36335 | | 36346 | | 36357 | | 36367 | | 36377 | | 36387 | | - | |
| 3 | 36314 | | 36325 | | 36336 | | 36347 | | 36358 | | 36368 | | 36378 | | 36388 | | 36397 | |
| 3 1/2 | 36315 | | 36326 | | 36337 | | 36348 | | 36359 | | 36369 | | 36379 | | 36389 | | 36398 | |
| 4 | 36316 | | 36327 | | 36338 | | 36349 | | 36360 | | 36370 | | 36380 | | 36390 | | 36399 | |
| 4 1/2 | 36317 | | 36328 | | 36339 | | 36350 | | 36361 | | 36371 | | 36381 | | 36391 | | 36400 | |
| 5 | 36318 | | 36329 | | 36340 | | 36351 | | 36362 | | 36372 | | 36382 | | 36392 | | 36401 | |
| 5 1/2 | 36319 | | 36330 | | 36341 | | 36352 | | 36363 | | 36373 | | 36383 | | 36393 | | 36402 | |
| 6 | 36320 | | 36331 | | 36342 | | 36353 | | 36364 | | 36374 | | 36384 | | 36394 | | 36403 | |

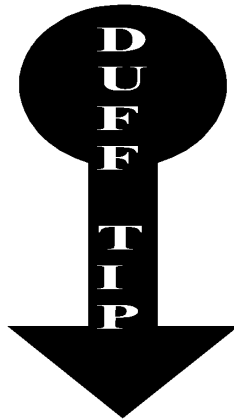

When ordering Stainless Steel Nipples or Fittings, don't forget to order our special teflon tape for Stainless Steel (Fig No. 61360)!



VICTAULIC FITTINGS

CALL FOR PRICING!

Victaulic®
Grooved Piping Method

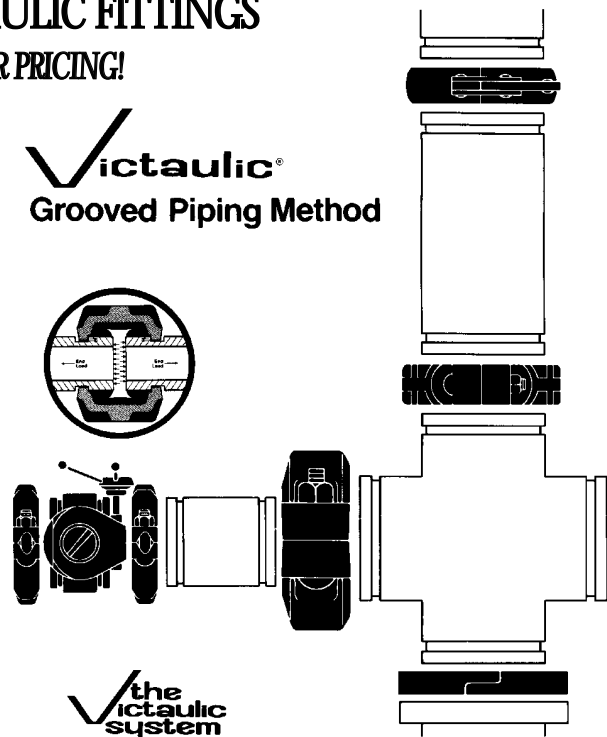

the victaulic system

STAINLESS STEEL THREADED FITTINGS



90° ELBOW



90° STREET ELBOW



45° ELBOW



Tee

| | 304 | | 316 | | 304 | | 316 | | 304 | | 316 | | 304 | | 316 | |
|-------|----------|-------|----------|-------|----------|-------|----------|-------|----------|-------|----------|-------|----------|-------|----------|-------|
| SIZE | FIG. NO. | PRICE | FIG. NO. | PRICE | FIG. NO. | PRICE | FIG. NO. | PRICE | FIG. NO. | PRICE | FIG. NO. | PRICE | FIG. NO. | PRICE | FIG. NO. | PRICE |
| 1/8 | 6552 | | 6872 | | 6627 | | 6900 | | 6585 | | 6881 | | 6607 | | 6891 | |
| 1/4 | 6557 | | 6873 | | 6629 | | 6901 | | 6587 | | 6882 | | 17581 | | 6892 | |
| 3/8 | 6561 | | 6874 | | 6633 | | 6902 | | 6589 | | 6883 | | 6609 | | 6893 | |
| 1/2 | 6566 | | 6875 | | 6635 | | 6903 | | 6591 | | 6884 | | 6611 | | 6894 | |
| 3/4 | 17565 | | 6876 | | 6639 | | 6904 | | 6593 | | 6885 | | 6615 | | 6895 | |
| 1 | 17580 | | 6877 | | 6642 | | 6905 | | 17566 | | 6887 | | 6617 | | 6896 | |
| 1 1/4 | 6574 | | 6878 | | 6646 | | 6906 | | 17567 | | 6888 | | 6621 | | 6897 | |
| 1 1/2 | 6577 | | 6879 | | 6649 | | 6907 | | 17568 | | 6889 | | 6624 | | 6898 | |
| 2 | 6579 | | 6880 | | 6652 | | 6908 | | 6604 | | 6890 | | 6625 | | 6899 | |
| 2 1/2 | 33260 | | 33303 | | - | | - | | 33262 | | 33306 | | 33265 | | 33309 | |
| 3 | 32783 | | 33304 | | - | | - | | 33263 | | 33307 | | 32781 | | 33310 | |
| 4 | 33261 | | 33305 | | - | | - | | 33264 | | 33308 | | 33266 | | 33311 | |

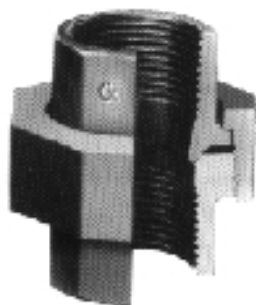

Union



Coupling



Cap



Square Head Plug

| | 304 | | 316 | | 304 | | 316 | | 304 | | 316 | | 304 | | 316 | |
|-------|----------|-------|----------|-------|----------|-------|----------|-------|----------|-------|----------|-------|----------|-------|----------|-------|
| SIZE | FIG. NO. | PRICE | FIG. NO. | PRICE | FIG. NO. | PRICE | FIG. NO. | PRICE | FIG. NO. | PRICE | FIG. NO. | PRICE | FIG. NO. | PRICE | FIG. NO. | PRICE |
| 1/8 | 6687 | | 6918 | | 6711 | | 6927 | | 6655 | | 6909 | | 17573 | | 6936 | |
| 1/4 | 6689 | | 6919 | | 6713 | | 6928 | | 6659 | | 6910 | | 6723 | | 6937 | |
| 3/8 | 17569 | | 6920 | | 6714 | | 6929 | | 6666 | | 6911 | | 6724 | | 6938 | |
| 1/2 | 6695 | | 6921 | | 17571 | | 6930 | | 6669 | | 6912 | | 6725 | | 6939 | |
| 3/4 | 6697 | | 6922 | | 17522 | | 6931 | | 6672 | | 6913 | | 6726 | | 6940 | |
| 1 | 6700 | | 6923 | | 6718 | | 6932 | | 6677 | | 6914 | | 6727 | | 6941 | |
| 1 1/4 | 6703 | | 6924 | | 6719 | | 6933 | | 6680 | | 6915 | | 6728 | | 6942 | |
| 1 1/2 | 6707 | | 6925 | | 6720 | | 6934 | | 6682 | | 6916 | | 6729 | | 6943 | |
| 2 | 17570 | | 6926 | | 6721 | | 6935 | | 6684 | | 6917 | | 6730 | | 6944 | |
| 2 1/2 | 33269 | | - | | 33272 | | 33315 | | 32240 | | 33312 | | 33283 | | 33318 | |
| 3 | 33270 | | - | | 33273 | | 33316 | | 33267 | | 33313 | | 33284 | | 33319 | |
| 4 | 33271 | | - | | 33274 | | 33317 | | 33268 | | 33314 | | 33285 | | 33320 | |

STAINLESS STEEL HEX BUSHING

| SIZE | | 304 | | 316 | | SIZE | | 304 | | 316 | |
|-------|-------|----------|-------|----------|-------|-------|-------|----------|-------|----------|-------|
| | | FIG. NO. | PRICE | FIG. NO. | PRICE | | | FIG. NO. | PRICE | FIG. NO. | PRICE |
| 1/4 | 1/8 | 6836 | | 6945 | | 2 | 1 1/2 | 6864 | | 6973 | |
| 3/8 | 1/4 | 6837 | | 6946 | | | 1 1/4 | 6865 | | 6974 | |
| | 1/8 | 6838 | | 6947 | | | 1 | 6866 | | 6975 | |
| 1/2 | 3/8 | 6839 | | 6948 | | | 3/4 | 6867 | | 6976 | |
| | 1/4 | 6840 | | 6949 | | | 1/2 | 6868 | | 6977 | |
| | 1/8 | 6841 | | 6950 | | | 3/8 | 6869 | | 6978 | |
| 3/4 | 1/2 | 6842 | | 6951 | | | 1/4 | 6870 | | 6979 | |
| | 3/8 | 6843 | | 6952 | | | 1/8 | 6871 | | 6980 | |
| | 1/4 | 6844 | | 6953 | | 2 1/2 | 1/2 | 33286 | | 33322 | |
| | 1/8 | 6845 | | 6954 | | | 3/4 | 33287 | | 33323 | |
| 1 | 3/4 | 6846 | | 6955 | | | 1 | 33288 | | 33324 | |
| | 1/2 | 6847 | | 6956 | | | 1 1/4 | 33289 | | 33325 | |
| | 3/8 | 6848 | | 6957 | | | 1 1/2 | 33290 | | 33326 | |
| | 1/4 | 6849 | | 6958 | | | 2 | 33291 | | 33327 | |
| | 1/8 | 6850 | | 6959 | | 3 | 1/2 | 33292 | | 33328 | |
| 1 1/4 | 1 | 6851 | | 6960 | | | 3/4 | 33293 | | 33330 | |
| | 3/4 | 6852 | | 6961 | | | 1 | 33294 | | 33331 | |
| | 1/2 | 6853 | | 6962 | | | 1 1/4 | 33295 | | 33332 | |
| | 3/8 | 6854 | | 6963 | | | 1 1/2 | 33296 | | 33333 | |
| | 1/4 | 6855 | | 6964 | | | 2 | 32782 | | 33334 | |
| | 1/8 | 6856 | | 6965 | | | 2 1/2 | 33297 | | 33337 | |
| 1 1/2 | 1 1/4 | 6857 | | 6966 | | 4 | 1 | 33298 | | 33338 | |
| | 1 | 6858 | | 6967 | | | 1 1/4 | 33299 | | 33339 | |
| | 3/4 | 6859 | | 6968 | | | 1 1/2 | 33300 | | 33340 | |
| | 1/2 | 6860 | | 6969 | | | 2 | 32796 | | 33341 | |
| | 3/8 | 6861 | | 6970 | | | 2 1/2 | 333013 | | 33342 | |
| | 1/4 | 6862 | | 6971 | | | 3 | 2795 | | 33343 | |
| | 1/8 | 6863 | | 6972 | | | | | | | |

SCHEDULE 40 STAINLESS STEEL WELDED PIPE

Priced per foot in full random lengths. Prices on Application.

| TYPE | 1/4 | | 3/8 | | 1/2 | | 3/4 | | 1 | | 1 1/4 | | 1 1/2 | | 2 | |
|------|----------|-------|----------|-------|----------|-------|----------|-------|----------|-------|----------|-------|----------|-------|----------|-------|
| | FIG. NO. | PRICE | FIG. NO. | PRICE | FIG. NO. | PRICE | FIG. NO. | PRICE | FIG. NO. | PRICE | FIG. NO. | PRICE | FIG. NO. | PRICE | FIG. NO. | PRICE |
| 304 | 6982 | | 6983 | | 6984 | | 6985 | | 6986 | | 6987 | | 6988 | | 6989 | |
| 316 | 17574 | | 6992 | | 6993 | | 6994 | | 6995 | | 6996 | | 6997 | | 6998 | |

Call DUFF for Monel,
Hastelloy, Inconel fittings and
valves and Aluminum pipe
fittings.

Forged Stainless and most alloys in 2000, 3000, 4000 and 6000 lbs., both screwed and socket weld, are available. On the shelf for immediate delivery are all types of Stainless Steel valves including gate, globe, check, ball, diaphragm and pop safety valves.

COPPER WATER TUBE/ENGINEERING DATA

| Nom- inal Tube Size in Inches | Out- side Diam- eter in Inches | TOLERANCE Tubing O. D. in inches | | TYPE "K" | | | | | | TYPE "L" | | | | | |
|--|---|--|--|--|-------------------------------------|--------------------------------------|--|--------------------------------------|--|--|-------------------------------------|------------|-----|---------------|-----|
| | | | | Hard Drawn—20 Ft. Straight Lengths Soft Annealed—20 Ft. Straight Lengths or 40 Ft. and 60 Ft. Length Coils (to and including 1/2") | | | | | | Hard Drawn—20 Ft. Straight Lengths Soft Annealed—20 Ft. Straight Lengths or 40 Ft. and 60 Ft. Length Coils (to and including 1/2") | | | | | |
| | | | | Use: For Underground Service and General Plumbing and Heating Installations under Severe Conditions. | | | | | | Use: For General Plumbing and Heating Installations. | | | | | |
| | | | | Wall Thick- ness in inches | Weight per Foot in Lbs. | HARD DRAWN | | SOFT ANNEALED | | Wall Thick- ness in inches | Weight per Foot in Lbs. | HARD DRAWN | | SOFT ANNEALED | |
| Bursting Pressure in Lbs. * | Safe Working Stress in Lbs. ⓧ● | Bursting Pressure in Lbs. * | Safe Working Stress in Lbs. ☆● | | | Bursting Pressure in Lbs. * | Safe Working Stress in Lbs. ⓧ● | Bursting Pressure in Lbs. * | Safe Working Stress in Lbs. ☆● | | | | | | |
| 1/8" | .375 | .376 | .374 | .035 | .145 | 6720 | 1060 | 5600 | 930 | .030 | .126 | 5760 | 900 | 4800 | 800 |
| 1/4" | .500 | .501 | .499 | .049 | .269 | 7100 | 1170 | 5900 | 980 | .035 | .198 | 5000 | 800 | 4200 | 700 |
| 3/8" | .625 | .626 | .624 | .049 | .344 | 5600 | 920 | 4700 | 780 | .040 | .285 | 4600 | 740 | 3800 | 630 |
| 1/2" | .750 | .751 | .749 | .049 | .418 | 4700 | 760 | 3900 | 650 | .042 | .362 | 4000 | 650 | 3400 | 560 |
| 5/8" | .875 | .876 | .874 | .065 | .641 | 5300 | 880 | 4500 | 750 | .045 | .455 | 3700 | 590 | 3100 | 510 |
| 1" | 1.125 | 1.1265 | 1.1235 | .065 | .839 | 4200 | 680 | 3500 | 580 | .050 | .655 | 3200 | 510 | 2700 | 450 |
| 1 1/4" | 1.375 | 1.3765 | 1.3735 | .065 | 1.04 | 3400 | 550 | 2800 | 465 | .055 | .884 | 2900 | 460 | 2400 | 400 |
| 1 1/2" | 1.625 | 1.627 | 1.623 | .072 | 1.36 | 3200 | 520 | 2700 | 450 | .060 | 1.14 | 2700 | 430 | 2200 | 360 |
| 2" | 2.125 | 2.127 | 2.123 | .083 | 2.06 | 2800 | 450 | 2300 | 380 | .070 | 1.75 | 2400 | 370 | 2000 | 330 |
| 2 1/4" | 2.625 | 2.627 | 2.623 | .095 | 2.92 | 2600 | 420 | 2200 | 360 | .080 | 2.48 | 2220 | 350 | 1800 | 300 |
| 3" | 3.125 | 3.127 | 3.123 | .109 | 4.00 | 2500 | 410 | 2100 | 350 | .090 | 3.33 | 2100 | 330 | 1700 | 280 |
| 3 1/2" | 3.625 | 3.627 | 3.623 | .120 | 5.12 | 2400 | 380 | 2000 | 330 | .100 | 4.29 | 2000 | 320 | 1700 | 280 |
| 4" | 4.125 | 4.127 | 4.123 | .134 | 6.51 | 2300 | 370 | 1900 | 320 | .110 | 5.38 | 1900 | 300 | 1600 | 260 |
| 5" | 5.125 | 5.127 | 5.123 | .160 | 9.67 | 2300 | 360 | 1900 | 320 | .125 | 7.61 | 1800 | 280 | 1500 | 250 |
| 6" | 6.125 | 6.127 | 6.123 | .192 | 13.87 | 2200 | 370 | 1900 | 320 | .140 | 10.20 | 1600 | 260 | 1400 | 230 |
| 8" | 8.125 | 8.127 | 8.123 | .271 | 25.90 | 2400 | 390 | 2000 | 330 | .200 | 19.29 | 1800 | 280 | 1500 | 250 |
| 10" | 10.125 | 10.127 | 10.119 | .338 | 40.3 | 2400 | 390 | 2000 | 330 | .250 | 30.1 | 1800 | 290 | 1500 | 250 |
| 12" | 12.125 | 12.127 | 12.119 | .405 | 57.8 | 2400 | 400 | 2000 | 330 | .280 | 40.4 | 1700 | 270 | 1400 | 230 |

Note: Information and data contained in these charts as taken from A. S. T. M. Specifications No. B-88-75, Federal Specification WW-T-799, and various Copper Tube Mill chart standards.

ⓧ From Cabra based on 150°F. with an allowable stress of 6000 P.S.I.

* Bursting pressures are calculated from the following Formula for thin, hollow cylinders under tension:

$$P = \frac{2tS}{D}$$

Where P = Bursting pressure, Lb. per Sq. In.

t = Wall thickness, inches

D = Outside tube diameter, inches

S = Tensile strength (36,000 Lb. per Sq. In. for hard tubes and 30,000 for soft tubes)

☆ With safety factor of 6, maximum safe working pressure allowable by common usage up to 150°F. can be taken at 1/6 the above bursting pressure

● Rated internal pressure for copper water tube based on the strength of the tube alone and applicable to systems using suitable mechanical joints. (Pounds per Sq. inch).

| Nom- inal Tube Size in Inches | Out- side Diam- eter in Inches | TOLERANCE Tubing O. D. in inches | | TYPE "M" | | | | TYPE "DWV" | | | |
|--|---|--|------------------------------------|---|-------------------------------------|------------|-----|---|-------------------------------------|------------|-------|
| | | | | Hard Drawn Only—20 Ft. Straight Lengths | | | | Hard Drawn Only—20 Ft. Straight Lengths | | | |
| | | | | Use: For General Plumbing, Heating and Drainage Installations. | | | | Use: For Drain, Waste, Vent and other non-pressure applications. | | | |
| | | | | Wall Thick- ness in inches | Weight per Foot in Lbs. | HARD DRAWN | | Wall Thick- ness in inches | Weight per Foot in Lbs. | HARD DRAWN | |
| Bursting Pressure in Lbs. * | Safe Working Stress in Lbs. ⓧ● | Bursting Pressure in Lbs. | Bursting Pressure in Lbs. | | | | | | | | |
| 1/8" | .500 | .501 | .499 | .025 | .144 | 3600 | 560 | | | | |
| 1/4" | .625 | .626 | .624 | .028 | .203 | 3230 | 510 | | | | |
| 3/8" | .875 | .876 | .874 | .032 | .328 | 2640 | 420 | | | | |
| 1" | 1.125 | 1.1265 | 1.1235 | .035 | .464 | 2240 | 340 | | | | |
| 1 1/4" | 1.375 | 1.3765 | 1.3735 | .042 | .681 | 2220 | 340 | .040 | .650 | 1950 | |
| 1 1/2" | 1.625 | 1.627 | 1.623 | .049 | .940 | 2170 | 340 | .042 | .809 | 1740 | |
| 2" | 2.125 | 2.127 | 2.123 | .058 | 1.46 | 1965 | 300 | .042 | 1.07 | 1310 | |
| 2 1/4" | 2.625 | 2.627 | 2.623 | .065 | 2.03 | 1780 | 280 | | | | |
| 3" | 3.125 | 3.127 | 3.123 | .072 | 2.68 | 1660 | 260 | .045 | 1.69 | 950 | |
| 3 1/2" | 3.625 | 3.627 | 3.623 | .083 | 3.58 | 1640 | 260 | | | | |
| 4" | 4.125 | 4.127 | 4.123 | .095 | 4.66 | 1650 | 260 | .058 | 2.87 | 900 | |
| 5" | 5.125 | 5.127 | 5.123 | .109 | 6.66 | 1530 | 240 | .072 | 4.43 | 910 | |
| 6" | 6.125 | 6.127 | 6.123 | .122 | 8.91 | 1430 | 230 | .083 | 6.10 | 890 | |
| 8" | 8.125 | 8.127 | 8.123 | .170 | 16.46 | 1510 | 240 | | | | |
| 10" | 10.125 | 10.127 | 10.119 | .212 | 25.6 | 1510 | 240 | | | | |
| 12" | 12.125 | 12.127 | 12.119 | .254 | 36.7 | 1510 | 240 | | | | |

ⓧ From Cabra based on 150°F. with an allowable stress of 6000 P.S.I.

* Bursting pressures are calculated from the following Formula for thin, hollow cylinders under tension:

$$P = \frac{2tS}{D}$$

Where P = Bursting pressure, Lb. per Sq. In.

t = Wall thickness, inches

D = Outside tube diameter, inches

S = Tensile strength (36,000 Lb. per Sq. in. for hard tubes and 30,000 for soft tubes)

☆ With safety factor of 6, maximum safe working pressure allowable by common usage up to 150°F. can be taken at 1/8 the above bursting pressure

● Rated internal pressure for copper water tube based on the strength of the tube alone and applicable to systems using suitable mechanical joints. (Pounds per Square inch).

Refrigeration Tubing (50 Foot Coils)

| OD | WALL |
|-------|------|
| 1/8 | .030 |
| 3/16 | .030 |
| 1/4 | .030 |
| 5/16 | .032 |
| 3/8 | .032 |
| 1/2 | .032 |
| 5/8 | .035 |
| 3/4 | .035 |
| 7/8 | .045 |
| 1 1/8 | .050 |
| 1 3/8 | .055 |
| 1 5/8 | .060 |

COPPER WATER TUBE

| NOM. SIZE | HARD TUBING (20' LENGTH) | | | | | | | |
|-----------|--------------------------|-------|--------|-------|--------|-------|------|-------|
| | TYPE M | | TYPE L | | TYPE K | | DWV | |
| | FIG. | PRICE | FIG. | PRICE | FIG. | PRICE | FIG. | PRICE |
| 1/8 | - | - | 25607 | - | - | - | - | - |
| 1/4 | - | - | 7504 | 7515 | - | - | - | - |
| 3/8 | 7513 | - | 1661 | 7516 | - | - | - | - |
| 1/2 | 1671 | - | 1662 | 7518 | - | - | - | - |
| 3/4 | 1672 | - | 1663 | 7521 | - | - | - | - |
| 1 | 1673 | - | 1664 | 7522 | - | - | - | - |
| 1 1/4 | 1674 | - | 1665 | 7524 | 7538 | - | - | - |
| 1 1/2 | 1675 | - | 1666 | 7525 | 1680 | - | - | - |
| 2 | 1676 | - | 1667 | 7528 | 1681 | - | - | - |
| 2 1/2 | 1677 | - | 1668 | 7531 | - | - | - | - |
| 3 | 1678 | - | 1669 | 7534 | 1682 | - | - | - |
| 4 | 1679 | - | 1670 | 7536 | 1683 | - | - | - |
| 5 | - | - | 7510 | - | - | - | - | - |
| 6 | - | - | 7512 | - | - | - | - | - |
| 8 | - | - | 63826 | - | - | - | - | - |

| 10' LENGTH | | |
|------------|------|------|
| 1/2 | 7545 | 7541 |
| 3/4 | 7552 | 7543 |

| SOFT TUBING | | | | | |
|--------------|--------|--------|-------|--------|-------|
| N O M . SIZE | LENGTH | TYPE L | | TYPE K | |
| | | FIG. | PRICE | FIG. | PRICE |
| 1/4 | 30 | 7556 | - | 7567 | - |
| | 60 | 1684 | - | 7565 | - |
| 3/8 | 30 | 7557 | - | 7572 | - |
| | 60 | 1685 | - | 1689 | - |
| 1/2 | 30 | 7558 | - | 7574 | - |
| | 60 | 1686 | - | 1690 | - |
| | 100 | 5840 | - | - | - |
| 3/4 | 30 | 7559 | - | 7576 | - |
| | 60 | 1687 | - | 1691 | - |
| | 100 | 5841 | - | 19783 | - |
| 1 | 30 | 7561 | - | 7578 | - |
| | 60 | 1688 | - | 1692 | - |
| | 100 | 5842 | - | 18987 | - |
| 1 1/4 | 60 | - | - | 1693 | - |
| 1 1/2 | 60 | 38575 | - | 1694 | - |
| 2 | 40 | - | - | 1695 | - |

ACTUAL OUTSIDE DIAMETERS OF TUBING

1/8" 3/16" 1/4" 5/16" 3/8" 1/2" 5/8" 3/4" 7/8" 1"

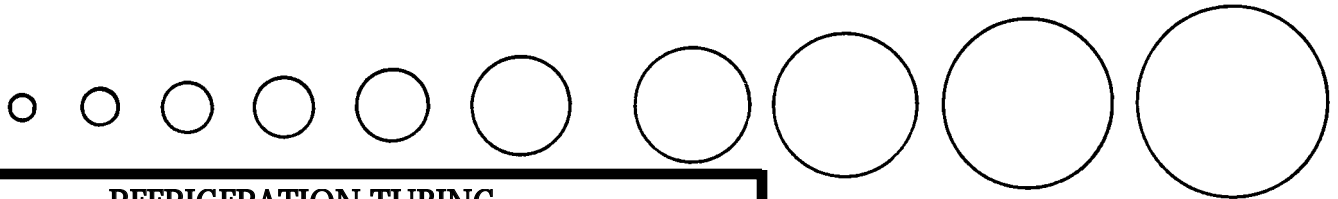

REFRIGERATION TUBING

| SIZE OD | COILS (Soft) 50' | | LENGTHS (Hard) 20' | |
|---------|------------------|-------|--------------------|-------|
| | FIG. | PRICE | FIG. | PRICE |
| 1/8 | 5838 | - | - | - |
| 3/16 | 7579 | - | - | - |
| 1/4 | 1696 | - | - | - |
| 5/16 | 7581 | - | - | - |
| 3/8 | 5839 | - | 7590 | - |
| 1/2 | 7583 | - | 7592 | - |
| 5/8 | 7585 | - | 7593 | - |
| 3/4 | 7587 | - | 7660 | - |
| 7/8 | 7588 | - | 7661 | - |
| 1 1/8 | - | - | 7662 | - |
| 1 3/8 | - | - | 7663 | - |
| 1 5/8 | - | - | 7664 | - |

BRASS PIPE (12' LENGTH)

| Size | Fig No | Price |
|-------|--------|-------|
| 1/8 | 21146 | - |
| 1/4 | 7665 | - |
| 3/8 | 7666 | - |
| 1/2 | 7667 | - |
| 3/4 | 7668 | - |
| 1 | 7672 | - |
| 1 1/4 | 7673 | - |
| 1 1/2 | 7674 | - |
| 2 | 7675 | - |
| 3 | 7677 | - |



THE OUTSIDE DIAMETER OF ANY SIZE COPPER WATER TUBE IS ALWAYS THE SAME, NO MATTER IF IT IS TYPE L, M, K, OR DWV!

COPPER FITTINGS



| SIZE | 90° Elbow CXC | | 45° Elbow CXC | | 90° Elbow Ftg X C | | 45° Elbow Ftg X C | | 90° LR Elbow C X C | |
|-------------|------------------|-------|------------------|-------|----------------------|-------|----------------------|-------|-----------------------|-------|
| | Fig No | Price | Fig No | Price | Fig No | Price | Fig No | Price | Fig No | Price |
| 1/8 | 13995 | | 14005 | | 14002 | | - | | - | |
| 1/4 | 1697 | | 14006 | | 14003 | | 14009 | | 26415 | |
| 3/8 | 1698 | | 1754 | | 1744 | | 1764 | | 26417 | |
| 3/8 X 1/4 | 5801 | | - | | - | | - | | - | |
| 1/2 | 1699 | | 1755 | | 1745 | | 1765 | | 26419 | |
| 1/2 X 1/4 | 13997 | | - | | - | | - | | - | |
| 1/2 X 3/8 | 1708 | | - | | - | | - | | - | |
| 5/8 | 13996 | | 14007 | | 14004 | | 14010 | | 26421 | |
| 5/8 x 1/2 | 40046 | | - | | - | | - | | - | |
| 5/8 x 3/4 | 40045 | | - | | - | | - | | - | |
| 3/4 | 1700 | | 1756 | | 1746 | | 1766 | | 26422 | |
| 3/4 X 3/8 | 36779 | | - | | - | | - | | - | |
| 3/4 X 1/2 | 1709 | | - | | - | | - | | - | |
| 7/8 | - | | - | | - | | - | | 35949 | |
| 1 | 1701 | | 1757 | | 1747 | | 1767 | | 26424 | |
| 1 x 3/8 | 36780 | | - | | - | | - | | - | |
| 1 X 1/2 | 1710 | | - | | - | | - | | - | |
| 1 X 3/4 | 1711 | | - | | - | | - | | - | |
| 1 1/4 | 1702 | | 1758 | | 1748 | | 1768 | | 26426 | |
| 1 1/4 X 1/2 | 1712 | | - | | - | | - | | - | |
| 1 1/4 X 3/4 | 1713 | | - | | - | | - | | - | |
| 1 1/4 X 1 | 1714 | | - | | - | | - | | - | |
| 1 1/2 | 1703 | | 1759 | | 1749 | | 1769 | | 26427 | |
| 1 1/2 x 1/2 | 1715 | | - | | - | | - | | - | |
| 1 1/2 x 3/4 | 1716 | | - | | - | | - | | - | |
| 1 1/2 x 1 | 1717 | | - | | - | | - | | - | |
| 1 1/2 x 1 | 1718 | | - | | - | | - | | - | |
| 1/4 | 1704 | | 1760 | | 1750 | | 1770 | | 26429 | |
| 2 | 1719 | | - | | - | | - | | - | |
| 2 x 3/4 | 1720 | | - | | - | | - | | - | |
| 2 x 1 | 5802 | | - | | - | | - | | - | |
| 2 x 1 1/4 | 1721 | | - | | - | | - | | - | |
| 2 x 1 1/2 | 1705 | | 1761 | | 1751 | | 1771 | | 26431 | |
| 2 1/2 | 35938 | | - | | - | | - | | - | |
| 2 1/2 x 1 | 35937 | | - | | - | | - | | - | |
| 1/4 | 33423 | | - | | - | | - | | 25701 | |
| 2 1/2 x 1 | 1706 | | 1762 | | 1752 | | 1772 | | 33440 | |
| 1/2 | 35939 | | - | | - | | - | | 25704 | |
| 2 1/2 x 2 | 1707 | | 1763 | | 1753 | | 5849 | | - | |
| 3 | 33420 | | 33403 | | - | | - | | - | |
| 3 1/2 | 33421 | | 33404 | | - | | - | | - | |
| 4 | 33422 | | 33406 | | - | | - | | - | |



Don't forget to order sandcloth, fitting brushes, flux and solder with copper fittings!

COPPER FITTINGS

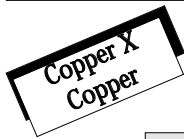

| SIZE | Coupling w/ Stop | | Coupling Without Stop | |
|---------------|------------------|-------|-----------------------|-------|
| | FIG. NO. | PRICE | FIG. NO. | PRICE |
| 1/8 | 14147 | | 33388 | |
| 1/4 | 1914 | | 5805 | - |
| 1/4 x 1/8 | 14148 | | - | - |
| 3/8 | 1915 | | 1904 | - |
| 3/8 x 1/8 | 26398 | | - | - |
| 3/8 x 1/4 | 1925 | | - | - |
| 1/2 | - | | 1905 | |
| 1/2 x 1/4 | 1926 | | - | |
| 1/2 x 3/8 | 1927 | | - | |
| 5/8 | 14104 | | 35894 | |
| 5/8 x 1/4 | 35886 | | - | |
| 5/8 x 3/8 | 35885 | | - | |
| 5/8 x 1/2 | 14105 | | - | |
| 3/4 | - | | 1906 | |
| 3/4 x 3/8 | 14149 | | - | |
| 3/4 X 1/2 | 1928 | | - | |
| 3/4 x 5/8 | 14106 | | - | |
| 1 | 1918 | | 1907 | |
| 1 x 3/8 | 14150 | | - | |
| 1 x 1/2 | 1929 | | - | |
| 1 x 5/8 | 35888 | | - | |
| 1 x 3/4 | 1930 | | - | |
| 1 1/4 | 1919 | | 1908 | |
| 1 1/4 x 1/2 | 1931 | | - | |
| 1 1/4 x 5/8 | 35889 | | - | |
| 1 1/4 x 3/4 | 1932 | | - | |
| 1 1/4 x 1 | 1933 | | - | |
| 1 1/2 | 1920 | | 1909 | |
| 1 1/2 x 1/2 | 1934 | | - | |
| 1 1/2 x 3/4 | 1935 | | - | |
| 1 1/2 x 1 | 1936 | | - | |
| 1 1/2 x 1 1/4 | 1937 | | - | |
| 2 | 1921 | | 1910 | |
| 2 x 1/2 | 1938 | | - | |
| 2 x 3/4 | 1939 | | - | |
| 2 x 1 | 1940 | | - | |
| 2 x 1 1/4 | 1941 | | - | |
| 2 1/2 | 1922 | | 1911 | |
| 2 1/2 x 1 | 22899 | | - | |
| 2 1/2 x 1 1/4 | 1943 | | - | |
| 2 1/2 x 1 1/2 | 1944 | | - | |
| 2 1/2 x 2 | 1945 | | - | |
| 3 | 1923 | | 1912 | |
| 3 x 1 | 20599 | | - | |
| 3 x 1 1/4 | 23688 | | - | |
| 3 x 1 1/2 | 1946 | | - | |
| 3 x 2 | 1947 | | - | |
| 3 x 2 1/2 | 1948 | | - | |
| 3 1/2 | 35890 | | - | |
| 3 1/2 x 3 | 35891 | | - | |
| 4 | 1924 | | 1913 | |
| 4 x 2 | 1949 | | - | |
| 4 x 2 1/2 | 1950 | | - | |
| 4 x 3 | 1951 | | - | |
| 4 x 3 1/2 | 33381 | | - | |
| 5 | 33377 | | 33389 | |
| 5 x 3 | 33383 | | - | |
| 5 x 4 | 33382 | | - | |
| 6 | 33378 | | 33390 | |
| 6 x 2 | 33387 | | - | |
| 6 x 3 | 33386 | | - | |
| 6 x 4 | 33385 | | - | |
| 6 x 5 | 33384 | | - | |



| SIZE | Adapter CXM | | Adapter CXF | |
|---------------|-------------|-------|-------------|-------|
| | FIG. NO. | PRICE | FIG. NO. | PRICE |
| 1/8 | 33359 | | 30914 | |
| 1/8 X 1/4 | - | | 24003 | |
| 1/4 | 2020 | | 19634 | |
| 1/4 X 3/8 | 26446 | | 35904 | |
| 1/4 X 1/2 | 26445 | | 35903 | |
| 3/8 | 2021 | | 1998 | |
| 3/8 X 1/4 | 25798 | | 14065 | |
| 3/8 X 1/2 | 26449 | | 26399 | |
| 3/8 X 3/4 | 26448 | | - | |
| 3/8 X 1 | 26447 | | - | |
| 1/2 | 2022 | | 1999 | |
| 1/2 X 1/4 | 2031 | | 2008 | |
| 1/2 X 3/8 | 2032 | | 2009 | |
| 1/2 X 3/4 | 2033 | | 2010 | |
| 1/2 X 1 | 2034 | | 35905 | |
| 5/8 X 1/2 | 35917 | | 35907 | |
| 5/8 X 3/4 | 35902 | | 35906 | |
| 3/4 | 2023 | | 2000 | |
| 3/4 X 3/8 | 19646 | | 20168 | |
| 3/4 X 1/2 | 2035 | | 2011 | |
| 3/4 X 1 | 2036 | | 2012 | |
| 3/4 X 1 1/4 | 2037 | | 2013 | |
| 3/4 X 1 1/2 | 26450 | | - | |
| 1 | 2024 | | 2001 | |
| 1 X 1/2 | 2038 | | 2014 | |
| 1 X 3/4 | 2039 | | 2015 | |
| 1 X 1 1/4 | 2040 | | 2016 | |
| 1 X 1 1/2 | 2041 | | 26400 | |
| 1 X 2 | 14071 | | - | |
| 1 1/4 | 2025 | | 2002 | |
| 1 1/4 X 1/2 | - | | 35910 | |
| 1 1/4 X 3/4 | 21417 | | 35908 | |
| 1 1/4 X 1 | 2042 | | 2017 | |
| 1 1/4 X 1 1/2 | 2043 | | 2018 | |
| 1 1/4 X 2 | 14072 | | 20457 | |
| 1 1/2 | 2026 | | 2003 | |
| 1 1/2 X 3/4 | 20645 | | 14066 | |
| 1 1/2 X 1 | 2044 | | 14067 | |
| 1 1/2 X 1 1/4 | 2045 | | 2019 | |
| 1 1/2 X 2 | 2046 | | 14068 | |
| 2 | 2027 | | 2004 | |
| 2 X 1 | 14073 | | - | |
| 2 X 1 1/4 | 14074 | | 23003 | |
| 2 X 1 1/2 | 33363 | | 14069 | |
| 2 X 2 1/2 | 2047 | | - | |
| 2 1/2 | 2028 | | 2005 | |
| 2 1/2 X 2 | 14172 | | - | |
| 3 | 2029 | | 2006 | |
| 4 | 2030 | | 2007 | |
| 5 | 33361 | | - | |
| 6 | 33362 | | - | |

COPPER FITTINGS

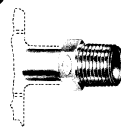

| Fitting Reducer Ftg X C | | | Flush Bushing Ftg X C | | Fitting Adapter Ftg X M | | Fitting Adapter Ftg X F | |
|-------------------------|----------|-------|-----------------------|-------|-------------------------|-------|-------------------------|-------|
| SIZE | FIG. NO. | PRICE | FIG. NO. | PRICE | FIG. NO. | PRICE | FIG. NO. | PRICE |
| 1/8 | - | - | - | - | 33364 | - | 33349 | - |
| 1/4 | - | - | - | - | 33365 | - | 33351 | - |
| 1/4 x 1/8 | 14029 | - | 35969 | - | - | - | - | - |
| 3/8 | - | - | - | - | 33366 | - | 2050 | - |
| 3/8 x 1/4 | 14030 | - | 5806 | - | - | - | - | - |
| 1/2 | - | - | - | - | 2048 | - | 2051 | - |
| 1/2 x 1/4 | 14031 | - | 5808 | - | - | - | 33355 | - |
| 1/2 x 3/8 | 14032 | - | 5807 | - | 33370 | - | 33353 | - |
| 1/2 x 3/4 | - | - | - | - | 33369 | - | 33354 | - |
| 3/4 | - | - | - | - | 2049 | - | 2052 | - |
| 3/4 x 1/4 | 14033 | - | - | - | - | - | - | - |
| 3/4 x 3/8 | 14034 | - | 1965 | - | - | - | - | - |
| 3/4 x 1/2 | 17753 | - | 1964 | - | 33372 | - | 14076 | - |
| 3/4 x 5/8 | 35900 | - | - | - | - | - | - | - |
| 1 | - | - | - | - | 5812 | - | 2053 | - |
| 1 x 3/8 | 26405 | - | - | - | - | - | - | - |
| 1 x 1/2 | 14035 | - | 1966 | - | - | - | - | - |
| 1 x 5/8 | 35901 | - | - | - | - | - | - | - |
| 1 x 3/4 | 14036 | - | 1967 | - | 33373 | - | 35911 | - |
| 1 1/4 | - | - | - | - | 5813 | - | 2054 | - |
| 1 1/4 x 1/2 | 14037 | - | - | - | - | - | - | - |
| 1 1/4 x 3/4 | 14038 | - | - | - | - | - | - | - |
| 1 1/4 x 1 | 14040 | - | 1970 | - | - | - | - | - |
| 1 1/2 | - | - | - | - | 5814 | - | 2055 | - |
| 1 1/2 x 1/2 | 14041 | - | - | - | - | - | - | - |
| 1 1/2 x 3/4 | 14042 | - | - | - | - | - | - | - |
| 1 1/2 x 1 | 14043 | - | - | - | - | - | - | - |
| 1 1/2 x 1 1/4 | 14044 | - | 1974 | - | - | - | - | - |
| 2 | - | - | - | - | 5815 | - | 2056 | - |
| 2 x 1/2 | 14045 | - | - | - | - | - | - | - |
| 2 x 3/4 | 14046 | - | - | - | - | - | - | - |
| 2 x 1 | 14047 | - | - | - | - | - | - | - |
| 2 x 1 1/4 | 14048 | - | - | - | - | - | - | - |
| 2 x 1 1/2 | 14049 | - | 1978 | - | - | - | - | - |
| 2 1/2 | - | - | - | - | 24131 | - | 35913 | - |
| 2 1/2 x 1 | 26407 | - | - | - | - | - | - | - |
| 2 1/2 x 1 1/4 | 14050 | - | - | - | - | - | - | - |
| 2 1/2 x 1 1/2 | 14051 | - | - | - | - | - | - | - |
| 2 1/2 x 2 | 14052 | - | - | - | - | - | - | - |
| 3 | - | - | - | - | 26401 | - | 35914 | - |
| 3x1 | 20260 | - | - | - | - | - | - | - |
| 3 x 1 1/4 | 14053 | - | - | - | - | - | - | - |
| 3 x 1 1/2 | 14054 | - | - | - | - | - | - | - |
| 3 x 2 | 14055 | - | - | - | - | - | - | - |
| 3 x 2 1/2 | 14056 | - | - | - | - | - | - | - |
| 3 1/2 x 3 | 33528 | - | - | - | - | - | - | - |
| 4 x 2 | 20081 | - | - | - | - | - | - | - |
| 4 x 2 1/2 | 14057 | - | - | - | - | - | - | - |
| 4 x 3 | 14058 | - | - | - | - | - | - | - |
| 4 x 3 1/2 | 33529 | - | - | - | - | - | - | - |
| 5 x 2 | 26410 | - | - | - | - | - | - | - |
| 5 x 3 | 26409 | - | - | - | - | - | - | - |
| 5 x 4 | 26408 | - | - | - | - | - | - | - |
| 6 x 3 | 26413 | - | - | - | - | - | - | - |
| 6 x 4 | 26412 | - | - | - | - | - | - | - |
| 6 x 5 | 26411 | - | - | - | - | - | - | - |

| Flush Bushing Ftg X F | | | Crossover C X C | |
|-----------------------|----------|-------|-----------------|-------|
| SIZE | FIG. NO. | PRICE | FIG. NO. | PRICE |
| 1/2 | - | - | 14199 | - |
| 1/2 x 1/8 | 1963 | - | - | - |
| 1/2 x 1/4 | 17681 | - | - | - |
| 3/4 | - | - | 14203 | - |
| 3/4 x 1/8 | 18965 | - | - | - |
| 3/4 x 1/4 | - | - | - | - |
| 3/4 x 3/8 | 18967 | - | - | - |
| 3/4 x 1/2 | 18969 | - | - | - |
| 1 x 1/2 | 19426 | - | - | - |
| 1 x 3/4 | 19425 | - | - | - |
| 1 1/4 x 3/4 | 35972 | - | - | - |
| 1 1/2 x 1 | 35973 | - | - | - |



COPPER TEES CXCXC

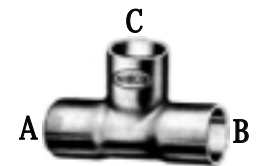

| SIZE | | | Fig No | Price |
|-------|-------|-------|--------|-------|
| A | B | C | | |
| 1/8 | 1/8 | 1/8 | 14011 | |
| 1/4 | 1/4 | 1/4 | 1773 | |
| 3/8 | 3/8 | 3/8 | 1774 | |
| 3/8 | 3/8 | 1/8 | 14013 | |
| 3/8 | 3/8 | 1/4 | 1784 | |
| 3/8 | 3/8 | 1/2 | 14014 | |
| 1/2 | 1/2 | 1/2 | 1775 | |
| 1/2 | 1/2 | 1/4 | 33555 | |
| 1/2 | 1/2 | 3/8 | 1785 | |
| 1/2 | 1/2 | 3/4 | 1786 | |
| 1/2 | 1/2 | 1 | 33553 | |
| 5/8 | 5/8 | 5/8 | 14012 | |
| 3/4 | 3/4 | 3/4 | 1776 | |
| 3/4 | 3/4 | 1/4 | 22929 | |
| 3/4 | 3/4 | 3/8 | 18119 | |
| 3/4 | 3/4 | 1/2 | 1787 | |
| 3/4 | 3/4 | 1 | 1790 | |
| 3/4 | 1/2 | 1/2 | 1788 | |
| 3/4 | 1/2 | 3/4 | 1789 | |
| 7/8 | 7/8 | 7/8 | 35963 | |
| 1 | 1 | 1 | 1777 | |
| 1 | 1 | 1/4 | 33579 | |
| 1 | 1 | 3/8 | 18120 | |
| 1 | 1 | 1/2 | 1791 | |
| 1 | 1/2 | 1/2 | 1792 | |
| 1 | 1/2 | 3/4 | 1793 | |
| 1 | 1/2 | 1 | 1794 | |
| 1 | 1 | 5/8 | 33578 | |
| 1 | 1 | 3/4 | 1795 | |
| 1 | 3/4 | 1/2 | 1796 | |
| 1 | 3/4 | 3/4 | 1797 | |
| 1 | 3/4 | 1 | 1798 | |
| 1 | 3/4 | 1 1/4 | 40044 | |
| 1 | 1 | 1 1/4 | 33577 | |
| 1 | 1 | 1 1/2 | 33576 | |
| 1 1/4 | 1 1/4 | 1 1/4 | 1778 | |
| 1 1/4 | 1 1/4 | 3/8 | 33582 | |
| 1 1/4 | 1 1/4 | 3/4 | 1801 | |
| 1 1/4 | 1/2 | 1/2 | 33584 | |
| 1 1/4 | 1/2 | 3/4 | 1802 | |
| 1 1/4 | 1/2 | 1 | 1803 | |
| 1 1/4 | 1/2 | 1 1/4 | 22222 | |
| 1 1/4 | 1 1/4 | 3/4 | 1804 | |
| 1 1/4 | 3/4 | 1/2 | 33583 | |
| 1 1/4 | 3/4 | 3/4 | 1805 | |
| 1 1/4 | 3/4 | 1 | 1806 | |
| 1 1/4 | 3/4 | 1 1/4 | 1807 | |
| 1 1/4 | 1 1/4 | 1 | 1808 | |
| 1 1/4 | 1 | 1/2 | 1809 | |
| 1 1/4 | 1 | 3/4 | 1810 | |
| 1 1/4 | 1 | 1 | 1811 | |
| 1 1/4 | 1 | 1 1/4 | 1812 | |
| 1 1/4 | 1 1/4 | 1 1/2 | 27957 | |
| 1 1/2 | 1 1/2 | 1 1/2 | 1779 | |
| 1 1/2 | 1 1/2 | 1/2 | 1813 | |
| 1 1/2 | 1/2 | 1 | 33592 | |
| 1 1/2 | 1/2 | 1 1/4 | 33591 | |
| 1 1/2 | 1/2 | 1 1/2 | 1814 | |
| 1 1/2 | 1 1/2 | 3/8 | 40043 | |
| 1 1/2 | 1 1/2 | 3/4 | 1815 | |
| 1 1/2 | 3/4 | 1/2 | 33590 | |
| 1 1/2 | 3/4 | 3/4 | 1816 | |
| 1 1/2 | 3/4 | 1 | 33589 | |
| 1 1/2 | 3/4 | 1 1/4 | 22293 | |
| 1 1/2 | 3/4 | 1 1/2 | 1817 | |
| 1 1/2 | 1 1/2 | 1 | 1818 | |
| 1 1/2 | 1 | 1/2 | 33588 | |
| 1 1/2 | 1 | 3/4 | 1819 | |
| 1 1/2 | 1 | 1 | 1820 | |
| 1 1/2 | 1 | 1 1/4 | 1821 | |
| 1 1/2 | 1 | 1 1/2 | 1822 | |
| 1 1/2 | 1 1/2 | 1 1/4 | 1823 | |
| 1 1/2 | 1 1/4 | 1/2 | 33587 | |
| 1 1/2 | 1 1/4 | 3/4 | 1824 | |
| 1 1/2 | 1 1/4 | 1 | 1825 | |
| 1 1/2 | 1 1/4 | 1 1/4 | 1826 | |
| 1 1/2 | 1 1/4 | 1 1/2 | 1827 | |
| 1 1/2 | 1 1/2 | 2 | 33586 | |
| 1 1/2 | 1 1/2 | 2 1/2 | 33585 | |

| SIZE | | | Fig No | Price |
|-------|-------|-------|--------|-------|
| A | B | C | | |
| 2 | 2 | 2 | 1780 | |
| 2 | 2 | 1/2 | 1828 | |
| 2 | 1/2 | 2 | 1829 | |
| 2 | 2 | 3/4 | 1830 | |
| 2 | 3/4 | 2 | 1831 | |
| 2 | 2 | 1 | 1832 | |
| 2 | 1 | 1 | 21399 | |
| 2 | 1 | 2 | 1834 | |
| 2 | 2 | 1 1/4 | 1835 | |
| 2 | 2 | 1 1/2 | 1838 | |
| 2 | 1 1/2 | 1 | 1840 | |
| 2 | 1 1/2 | 1 1/4 | 1841 | |
| 2 | 1 1/2 | 1 1/2 | 1842 | |
| 2 | 1 1/2 | 2 | 1843 | |
| 2 | 2 | 1 1/2 | 33594 | |
| 2 | 2 | 3 | 33593 | |
| 2 1/2 | 2 1/2 | 2 1/2 | 1781 | |
| 2 1/2 | 2 1/2 | 1/2 | 1844 | |
| 2 1/2 | 1/2 | 2 1/2 | 1853 | |
| 2 1/2 | 2 1/2 | 3/4 | 1845 | |
| 2 1/2 | 3/4 | 2 1/2 | 1854 | |
| 2 1/2 | 2 1/2 | 1 | 1846 | |
| 2 1/2 | 1 | 2 1/2 | 1855 | |
| 2 1/2 | 2 1/2 | 1 1/4 | 1847 | |
| 2 1/2 | 1 1/4 | 2 1/2 | 1856 | |
| 2 1/2 | 2 1/2 | 1 1/2 | 1848 | |
| 2 1/2 | 1 1/2 | 1 1/2 | 33604 | |
| 2 1/2 | 1 1/2 | 2 | 33603 | |
| 2 1/2 | 1 1/2 | 3/4 | 1857 | |
| 2 1/2 | 2 1/2 | 2 | 1849 | |
| 2 1/2 | 2 | 1/2 | 33602 | |
| 2 1/2 | 2 | 3/4 | 33601 | |
| 2 1/2 | 2 | 1 | 1850 | |
| 2 1/2 | 2 | 1 1/4 | 1851 | |
| 2 1/2 | 2 | 1 1/2 | 1852 | |
| 2 1/2 | 2 | 2 | 25716 | |
| 2 1/2 | 2 | 2 1/2 | 1858 | |
| 3 | 3 | 3 | 1782 | |
| 3 | 3 | 1/2 | 1859 | |
| 3 | 3 | 3/4 | 1860 | |
| 3 | 3/4 | 3 | 30620 | |
| 3 | 3 | 1 | 1861 | |
| 3 | 1 | 3 | 33610 | |
| 3 | 3 | 1 1/4 | 1862 | |
| 3 | 1 1/4 | 3 | 33609 | |
| 3 | 3 | 1 1/2 | 1863 | |
| 3 | 1 1/2 | 3 | 33608 | |
| 3 | 3 | 2 | 1864 | |
| 3 | 2 | 2 | 1865 | |
| 3 | 2 | 2 1/2 | 33607 | |
| 3 | 2 | 3 | 1866 | |
| 3 | 3 | 2 1/2 | 1867 | |
| 3 | 2 1/2 | 3 | 33605 | |
| 3 1/2 | 3 1/2 | 3 1/2 | 35964 | |
| 4 | 4 | 4 | 1783 | |
| 4 | 4 | 1/2 | 23702 | |
| 4 | 4 | 3/4 | 20711 | |
| 4 | 4 | 1 | 23703 | |
| 4 | 4 | 1 1/4 | 23704 | |
| 4 | 4 | 1 1/2 | 23705 | |
| 4 | 4 | 2 | 1870 | |
| 4 | 2 | 2 | 25703 | |
| 4 | 2 | 4 | 33614 | |
| 4 | 4 | 2 1/2 | 1871 | |
| 4 | 2 1/2 | 4 | 33613 | |
| 4 | 4 | 3 | 1872 | |
| 4 | 3 | 2 | 33612 | |
| 4 | 3 | 2 1/2 | 1873 | |
| 4 | 3 | 3 | 33611 | |
| 4 | 3 | 4 | 32487 | |
| 5 | 5 | 5 | 33537 | |
| 6 | 6 | 6 | 33538 | |
| 8 | 8 | 8 | 33539 | |

COPPER FITTINGS



TUBE CAP



RETURN BEND CXC

| Size | Fig No | Price | Fig No | Price |
|-------|--------|-------|--------|-------|
| 1/4 | 1952 | | 33531 | |
| 3/8 | 1953 | | 33532 | |
| 1/2 | 1954 | | 14077 | |
| 5/8 | 14169 | | 29067 | |
| 3/4 | 1955 | | 2057 | |
| 1 | 1956 | | 14078 | |
| 1 1/4 | 1957 | | 14079 | |
| 1 1/2 | 1958 | | 14080 | |
| 2 | 1959 | | 14081 | |
| 2 1/2 | 1960 | | - | |
| 3 | 1961 | | - | |
| 4 | 1962 | | - | |
| 5 | 33375 | | - | |
| 6 | 33376 | | - | |



TEE CXCXF

| Size | Fig No | Price |
|-----------------|--------|-------|
| 1/4 | 26008 | |
| 1/4 X 1/8 | 33644 | |
| 3/8 | 14018 | |
| 3/8 X 1/4 | 33645 | |
| 3/8 X 1/2 | 14020 | |
| 1/2 | 1874 | |
| 1/2 X 1/8 | 33646 | |
| 1/2 X 1/4 | 14021 | |
| 1/2 X 3/8 | 14022 | |
| 1/2 X 3/4 | 21771 | |
| 3/4 | 1875 | |
| 3/4 X 3/8 | 14023 | |
| 3/4 X 1/2 | 1878 | |
| 3/4 X 1/2 X 1/2 | 33647 | |
| 3/4 X 1/2 X 3/4 | 1879 | |
| 3/4 X 1 | 29790 | |
| 1 | 1876 | |
| 1 X 3/4 | 1881 | |
| 1 X 3/4 X 1/2 | 33648 | |
| 1 X 3/8 | 19491 | |
| 1 X 1/2 | 1880 | |
| 1 1/4 | 8018 | |
| 1 1/4 X 1/2 | 1882 | |
| 1 1/4 X 3/4 | 1883 | |
| 1 1/4 X 1 | 1884 | |
| 1 1/2 | 1877 | |
| 1 1/2 X 1/2 | 18339 | |
| 1 1/2 X 3/4 | 1885 | |
| 1 1/2 X 1 | 33649 | |
| 2 | 33650 | |
| 2 X 1/2 | 1886 | |
| 2 X 3/4 | 1887 | |
| 2 X 1 | 1888 | |
| 2 X 1 1/4 | 44210 | |
| 2 X 1 1/2 | 33651 | |



TEE CXFXC

| Size | Fig No | Price |
|---------------------|--------|-------|
| 3/8 | 33652 | |
| 1/2 | 1890 | |
| 1/2 X 3/8 X 1/2 | 33654 | |
| 1/2 X 3/4 X 1/2 | 1891 | |
| 3/4 | 1889 | |
| 3/4 X 1/8 X 3/4 | 33656 | |
| 3/4 1/2 X 3/4 | 1892 | |
| 3/4 X 1/2 | 21660 | |
| 1 | 19427 | |
| 1 X 1/8 X 1 | 33657 | |
| 1 X 1/2 X | 1893 | |
| 1 X 3/4 X 1 | 1894 | |
| 1 1/4 | 33658 | |
| 1 1/4 X 1/2 X 1 1/4 | 23352 | |
| 1 1/4 X 3/4 X 1 1/4 | 1895 | |
| 1 1/2 | 33660 | |
| 1 1/2 X 3/4 X 1 1/2 | 26483 | |
| 1 1/2 X 1/2 X 1 1/2 | 1896 | |
| 2 | 36785 | |
| 2 X 3/4 X 2 | 40040 | |

TEE FXFXC



| Size | Fig No | Price |
|------|--------|-------|
| 1/2 | 20933 | |
| 3/4 | 20764 | |

**AVAILABLE FOR
IMMEDIATE
DELIVERY!**



Tee FXMXC



Tee CXFXF



Tee CXMXC



TEE CXCMX

| Size | Fig No | Price |
|------|--------|-------|
| 1/2 | 20929 | |
| 3/4 | 20930 | |

COPPER FITTINGS



| | | | | |
|----------------------|----------------------|---------------------------|---------------------------|-----------------------------------|
| 90° Elbow CXM | 90° Elbow CXF | 90° Drop Elbow CXF | 90° Drop Elbow CXC | 90° Flanged Sink Elbow CXF |
|----------------------|----------------------|---------------------------|---------------------------|-----------------------------------|

| Size | Fig No | Price | Fig No | Price | Fig No | Price | Fig No | Price | Fig No | Price |
|---------------|--------|-------|--------|-------|--------|-------|--------|-------|--------|-------|
| 1/4 | 14017 | | 26009 | | - | | - | | - | |
| 3/8 | 14016 | | 1722 | | 33495 | | - | | - | |
| 3/8 X 1/4 | 26441 | | 35955 | | - | | - | | - | |
| 3/8 X 1/2 | 13998 | | 1729 | | 33501 | | - | | - | |
| 3/8 X 3/4 | - | | 33493 | | - | | - | | - | |
| 1/2 | 1733 | | 1723 | | 1742 | | 1743 | | 22118 | |
| 1/2 X 1/4 | - | | 33489 | | - | | - | | - | |
| 1/2 X 3/8 | 26442 | | 1728 | | 13999 | | - | | - | |
| 1/2 X 3/4 | 1740 | | 1730 | | 21273 | | - | | - | |
| 3/4 | 1734 | | 1724 | | 14000 | | 33522 | | 23700 | |
| 3/4 X 3/8 | - | | 36499 | | - | | - | | - | |
| 3/4 X 1/2 | 26444 | | 1731 | | 33502 | | - | | - | |
| 3/4 X 1 | 23621 | | 22365 | | - | | - | | - | |
| 3/4 X 1 1/4 | - | | 33496 | | - | | - | | - | |
| 1 | 1735 | | 1725 | | - | | - | | - | |
| 1 X 1/2 | - | | 20574 | | - | | - | | - | |
| 1 X 3/4 | - | | 1732 | | - | | - | | - | |
| 1 X 1 1/4 | 25159 | | 33497 | | - | | - | | - | |
| 1 1/4 | 1736 | | 1726 | | - | | - | | - | |
| 1 1/4 X 1/2 | - | | 33500 | | - | | - | | - | |
| 1 1/4 X 3/4 | - | | 33499 | | - | | - | | - | |
| 1 1/4 X 1 | - | | 33498 | | - | | - | | - | |
| 1 1/4 X 1 1/2 | - | | 25788 | | - | | - | | - | |
| 1 1/2 | 1737 | | 1727 | | - | | - | | - | |
| 2 | 1738 | | 5848 | | - | | - | | - | |



90° Street Elbow CXF



90° Fitting Elbow Ftg X F



45° Elbow CXF



45° Elbow CXM



45° Fitting Elbow Ftg X M



45° Fitting Elbow Ftg x F

ALL AVAILABLE FOR QUICK DELIVERY!

COPPER FITTINGS

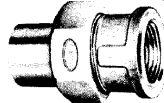
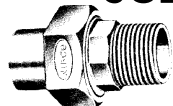

| | Union CXC | | Union CXM | | Union CXF | | Fitting Plug | | Cross CXCxCxC | |
|-------|-----------|-------|-----------|-------|-----------|-------|--------------|-------|---------------|-------|
| SIZE | FIG. NO. | PRICE | FIG. NO. | PRICE | FIG. NO. | PRICE | FIG. NO. | PRICE | FIG. NO. | PRICE |
| 1/8 | - | - | - | - | - | - | - | 36781 | - | - |
| 1/4 | 14060 | - | 33671 | - | - | - | - | 36782 | - | - |
| 3/8 | 1989 | - | 14061 | - | - | 33669 | - | 14180 | - | 14222 |
| 1/2 | 1990 | - | 5809 | - | - | 8814 | - | 14182 | - | 14224 |
| 5/8 | 35974 | - | - | - | - | - | - | - | - | - |
| 3/4 | 1991 | - | 5810 | - | - | 1996 | - | 14185 | - | 14226 |
| 1 | 1992 | - | 5811 | - | - | 1997 | - | 14188 | - | 14228 |
| 1 1/4 | 1993 | - | 14062 | - | - | 23708 | - | 14190 | - | 14229 |
| 1 1/2 | 1994 | - | 14063 | - | - | 23709 | - | 14193 | - | 14231 |
| 2 | 1995 | - | 14064 | - | - | 23710 | - | 14195 | - | 14233 |
| 2 1/2 | 14175 | - | 23711 | - | - | - | - | - | - | 14235 |
| 3 | 14177 | - | - | - | - | - | - | - | - | - |
| 4 | - | - | - | - | - | - | - | - | - | - |



| | 90° Union Elbow CXC | | 90° Union Elbow CXM | | 90° Union Elbow CXF | | 90° Y CXCxCxC | | 45° Y CXCxCxC | |
|-------|---------------------|-------|---------------------|-------|---------------------|-------|---------------|-------|---------------|-------|
| SIZE | FIG. NO. | PRICE | FIG. NO. | PRICE | FIG. NO. | PRICE | FIG. NO. | PRICE | FIG. NO. | PRICE |
| 3/8 | 14089 | - | - | - | - | - | - | - | - | - |
| 1/2 | 14090 | - | 33518 | - | 33509 | - | 14026 | - | 14151 | - |
| 3/4 | 14091 | - | 33519 | - | 33511 | - | 1901 | - | 14152 | - |
| 1 | 14092 | - | 33520 | - | 33512 | - | 1902 | - | 14153 | - |
| 1 1/4 | 33525 | - | - | - | - | - | 5803 | - | 14154 | - |
| 1 1/2 | - | - | - | - | - | - | 20294 | - | 20295 | - |



| | Coupling with Drain CXC | | Elbow with Drain CXC | | Bulkhead CXC | | Bulkhead CXM | | Bulkhead CXF | |
|-------|-------------------------|-------|----------------------|-------|--------------|-------|--------------|-------|--------------|-------|
| SIZE | FIG. NO. | PRICE | FIG. NO. | PRICE | FIG. NO. | PRICE | FIG. NO. | PRICE | FIG. NO. | PRICE |
| 3/8 | 14156 | - | - | - | - | - | - | - | 33374 | - |
| 1/2 | 14157 | - | 14164 | - | 14083 | - | 14217 | - | 14209 | - |
| 3/4 | 14158 | - | 14166 | - | 14084 | - | 14218 | - | 14212 | - |
| 1 | 14159 | - | 14167 | - | 14085 | - | 14221 | - | 14214 | - |
| 1 1/4 | 14160 | - | 22530 | - | - | - | - | - | - | - |

COPPER FITTINGS - DWV



| | 90° Elbow CXC | | 90° Elbow Ftg X C | | 45° Elbw CXC | | 45° Elbow FtgXC | |
|--|---------------|--|-------------------|--|--------------|--|-----------------|--|
|--|---------------|--|-------------------|--|--------------|--|-----------------|--|

| SIZE | Fig No | Price | Fig No | Price | Fig No | Price | Fig No | Price |
|---------------|--------|-------|--------|-------|--------|-------|--------|-------|
| 1 1/4 | 14388 | | 14390 | | 14392 | | 14394 | |
| 1 1/2 | 2058 | | 2062 | | 2066 | | 2070 | |
| 1 1/2 x 1 1/4 | 20259 | | - | | - | | - | |
| 2 | 2059 | | 2063 | | 2067 | | 2071 | |
| 2 x 1 1/2 | 23776 | | - | | - | | - | |
| 3 | 2060 | | 2064 | | 2068 | | 2072 | |
| 4 | 2061 | | 2065 | | 2069 | | 14380 | |



| | 22 1/2° Elbow CXC | | 11 1/4° Elbow C X C | | 60° Elbow CXC | | 90° Elbow C X F | | 90° Elbow CXM | |
|--|-------------------|--|---------------------|--|---------------|--|-----------------|--|---------------|--|
|--|-------------------|--|---------------------|--|---------------|--|-----------------|--|---------------|--|

| SIZE | Fig No | Price | Fig No | Price | Fig No | Price | Fig No | Price | Fig No | Price |
|-------|--------|-------|--------|-------|--------|-------|--------|-------|--------|-------|
| 1 1/4 | 33879 | | - | | 33880 | | - | | - | |
| 1 1/2 | 2073 | | 2076 | | 30654 | | 2079 | | 2081 | |
| 2 | 2074 | | - | | 33881 | | 2080 | | 14382 | |
| 3 | 2075 | | - | | 33883 | | - | | - | |
| 4 | 28328 | | - | | - | | - | | - | |



| | 90° Elbow with Heel Inlet CXCXC | | 90° Elbow with Side Inlet CXCXC | | Double Elbow CXC | |
|--|---------------------------------|--|---------------------------------|--|------------------|--|
|--|---------------------------------|--|---------------------------------|--|------------------|--|

| SIZE | Fig No | Price | Fig No | Price | Fig No | Price |
|-----------------------|--------|-------|--------|-------|--------|-------|
| 1 1/2 | - | | - | | 26453 | |
| 1 1/2 x 1 1/4 x 1 1/4 | - | | - | | 33899 | |
| 2 | - | | - | | 24241 | |
| 2 x 1 1/2 x 1 1/2 | - | | - | | 33900 | |
| 3 x 2 | 5816 | | 5818 | | - | |
| 3 x 1 1/2 | 5817 | | 5819 | | - | |
| 4 x 2 | - | | 19498 | | - | |

COPPER FITTINGS - DWV



| SIZE | TEE C X C X C | | TEE C X F X C | | TEE C X C X F | | DOUBLE TEE C X C X C X C | |
|-----------------------|---------------|-------|---------------|-------|---------------|-------|--------------------------|-------|
| | Fig No | Price | Fig No | Price | Fig No | Price | Fig No | Price |
| 1 1/4 | 14387 | - | - | - | - | - | 33896 | - |
| 1 1/2 | 23005 | - | 33893 | - | 2095 | - | 2097 | - |
| 1 1/2 x 1 1/4 | 14369 | - | - | - | - | - | 33895 | - |
| 1 1/2 x 1 1/4 x 1 1/2 | 33890 | - | - | - | - | - | - | - |
| 2 | 2083 | - | 33894 | - | 2096 | - | 2098 | - |
| 2 X 1 1/4 | 33891 | - | - | - | - | - | - | - |
| 2 X 1 1/2 | 2087 | - | - | - | 2084 | - | 2100 | - |
| 2 X 1 1/2 X 1 1/4 | 33892 | - | - | - | - | - | - | - |
| 2 X 1 1/2 X 1 1/2 | 2088 | - | - | - | - | - | - | - |
| 2 X 1 1/2 X 2 | 2089 | - | - | - | - | - | - | - |
| 3 | 2085 | - | - | - | - | - | 2099 | - |
| 3 X 1 1/4 | 25510 | - | - | - | - | - | - | - |
| 3 X 1 1/2 | 2090 | - | - | - | - | - | - | - |
| 3 X 2 | 2091 | - | - | - | - | - | 2102 | - |
| 4 | 2086 | - | - | - | - | - | - | - |
| 4 X 1 1/2 | 2092 | - | - | - | - | - | 27365 | - |
| 4 X 2 | 2093 | - | - | - | - | - | - | - |
| 4 X 3 | 2094 | - | - | - | - | - | - | - |

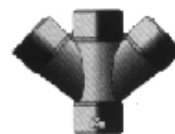

| Size | WYE C X C X C | | DOUBLE Y C X C X C | |
|-------------------|---------------|-------|--------------------|-------|
| | Fig No | Price | Fig No | Price |
| 1 1/4 | 14384 | - | - | - |
| 1 1/2 | 2103 | - | 2115 | - |
| 1 1/2 X 1 1/4 | 33905 | - | - | - |
| 2 | 2104 | - | - | - |
| 2 X 1 1/2 | 2107 | - | 2118 | - |
| 2 X 1 1/2 X 1 1/4 | 22804 | - | - | - |
| 2 X 1 1/2 X 1 1/2 | 2108 | - | - | - |
| 2 X 1 1/2 X 2 | 2109 | - | - | - |
| 3 | 2105 | - | - | - |
| 3 X 1 1/2 | 2110 | - | - | - |
| 3 X 2 | 2111 | - | - | - |
| 4 | 2106 | - | - | - |
| 4 X 1 1/2 | 2112 | - | - | - |
| 4 X 2 | 2113 | - | - | - |
| 4 X 3 | 2114 | - | - | - |

ALSO READILY AVAILABLE FOR YOUR CONVENIENCE!



45° Wye CXCXF



45° Wye CXFC

COPPER FITTINGS - DWV

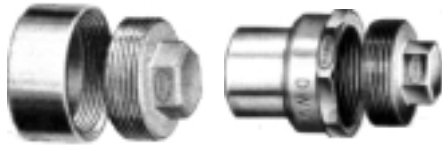

Flush Cleanout w/ Plug
FtgXF w/ Plug
Cleanout w/ Plug
FtgXF w/ Plug

| Size | Fig No | Price | Fig No | Price |
|-----------|--------|-------|--------|-------|
| 1 1/4 | - | - | 14395 | - |
| 1 1/4X3/4 | 33925 | - | - | - |
| 1 1/2 | - | - | 2121 | - |
| 1 1/2 X 1 | 33926 | - | - | - |
| 2 | - | - | 2122 | - |
| 2X1 1/2 | 33927 | - | - | - |
| 3 | - | - | 2123 | - |
| 3X2 1/2 | 33928 | - | - | - |
| 4 | - | - | 14371 | - |
| 4X3 | 33929 | - | - | - |



DWV COUPLING CXC
DWV REPAIR COU-
PLING CXC
FLUSH BUSHING
FTGXC

| Size | Fig No | Price | Fig No | Price | Fig No | Price |
|-------------|--------|-------|--------|-------|--------|-------|
| 1 1/4 | 14400 | - | - | - | - | - |
| 1 1/2 | 2127 | - | 2135 | - | - | - |
| 1 1/2X1 1/4 | 22459 | - | - | - | 33930 | - |
| 2 | 2128 | - | 2136 | - | - | - |
| 2 X 1 1/4 | 20341 | - | - | - | 33874 | - |
| 2 X 1 1/2 | 2131 | - | - | - | 33931 | - |
| 3 | 2129 | - | 2137 | - | - | - |
| 3 X 1 1/2 | 2132 | - | - | - | - | - |
| 3 X 2 | 2133 | - | - | - | 33932 | - |
| 4 | 2130 | - | 33875 | - | 33875 | - |
| 4X3 | 2134 | - | - | - | 33933 | - |



Soil Pipe Adapter C X Spigot



Adapter C X F



Adapter C X M

| Size | Fig No | Price | Fig No | Price | Fig No | Price |
|---------------|--------|-------|--------|-------|--------|-------|
| 1 1/4 | - | - | 14403 | - | 14406 | - |
| 1 1/4 x 1 1/2 | - | - | - | - | 23777 | - |
| 1 1/4 x 2 | 33909 | - | - | - | - | - |
| 1 1/2 | - | - | 2151 | - | 2158 | - |
| 1 1/2 x 1 1/4 | - | - | - | - | 21639 | - |
| 1 1/2 x 2 | 2149 | - | - | - | 23778 | - |
| 1 1/2 x 3 | 22735 | - | - | - | - | - |
| 1 1/2 x 4 | 23780 | - | - | - | - | - |
| 2 | - | - | 2152 | - | 2159 | - |
| 2 x 1 1/4 | - | - | - | - | 25187 | - |
| 2 x 1 1/2 | - | - | - | - | 23779 | - |
| 2 x 2 | 2146 | - | - | - | - | - |
| 2 x 3 | 2150 | - | - | - | - | - |
| 2 x 4 | 21391 | - | - | - | - | - |
| 3 | - | - | 2153 | - | 2160 | - |
| 3 x 3 | 2147 | - | - | - | - | - |
| 3 x 4 | 33912 | - | - | - | - | - |
| 4 | - | - | 5851 | - | 2161 | - |
| 4 x 2 | - | - | - | - | - | - |
| 4 x 3 | - | - | - | - | - | - |
| 4 x 4 | 2148 | - | - | - | - | - |

COPPER FITTINGS - DWV



P-Trap CXC





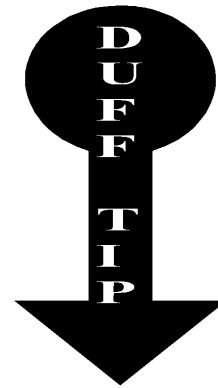

P-Trap w/ Union Joint (LA Style) CXSJ



When ordering any DWV copper fittings, don't forget to also order the solder and/or flux!

| SIZE | FIG. NO. | PRICE | FIG. NO. | PRICE |
|-------|----------|-------|----------|-------|
| 1 1/4 | 64864 | - | - | - |
| 1 1/2 | 64866 | - | 5828 | - |
| 2 | 64867 | - | - | - |

| |  |  |  |  | | | | |
|-----------|--|---|--|---|----------|-------|----------|-------|
| | Drum Trap | Return Bend CXC | Test cap | Test Tee CXC Cleanout w/ plug | | | | |
| SIZE | FIG. NO. | PRICE | FIG. NO. | PRICE | FIG. NO. | PRICE | FIG. NO. | PRICE |
| 1 1/4 | - | - | 14378 | - | 14415 | - | 14416 | - |
| 1 1/2 | - | - | 5831 | - | 10900 | - | 10903 | - |
| 1 1/2x3x5 | 14418 | - | - | - | - | - | - | - |
| 1 1/2x3x6 | 14421 | - | - | - | - | - | - | - |
| 2 | - | - | 5832 | - | 10901 | - | 10904 | - |
| 3 | - | - | 14377 | - | 10902 | - | 14365 | - |
| 4 | - | - | - | - | 14368 | - | 14368 | - |

ALSO READILY AVAILABLE FOR YOUR CONVENIENCE!



Offset Closet Fitting Ftg X C



Fitting Plug

COPPER FITTINGS - DWV



| SIZE | Trap Adapter Ftg X SJ | | Trap Adapter C X SJ | | Trap Adapter M X SJ | | Trap Adapter F X SJ | |
|---------------|-----------------------|-------|---------------------|-------|---------------------|-------|---------------------|-------|
| | Fig No | Price | Fig No | Price | Fig No | Price | Fig No | Price |
| 1 1/4 | 14408 | | 14411 | | 14409 | | 33916 | |
| 1 1/2 | 5821 | | 5822 | | 2164 | | 5820 | |
| 1 1/2 x 1 1/4 | 33913 | | 33914 | | 33918 | | 33917 | |
| 2 x 1 1/2 | - | | 21323 | | - | | - | |



| Size | Fig No | Price | Fig No | Price |
|-------|--------|-------|--------|-------|
| 3 x 4 | - | | 2165 | |
| 4 | 14330 | | - | |



| Size | Fig No | Price | Fig No | Price |
|-------|--------|-------|--------|-------|
| 1 1/4 | 14404 | | - | |
| 1 1/2 | 2154 | | 5850 | |
| 2 | 2155 | | 2162 | |
| 3 | 2156 | | - | |

ROTARY BALL & SWIVEL JOINTS

BARCO

Barco offers the steel industry an important combination of special benefits: (a) a wide variety of top-quality products for steelmaking applications, (b) single source efficiency, (c) local availability through a national network of Barco distributors.

Barco Ball Joints (many in service for more than 40 years with no maintenance) handle thermal expansion, vibration, shock and settling. They offer many advantages over slip joints, bellows or pipe loops...much less space is required, the need for guides and anchors is drastically reduced, and installation is faster and easier. Steelmaking applications include: steam decarburizing lines, hot process piping, distribution piping, hood cooling systems, flux chute and hood doors, trunnion rings, spray headers, de-scaling, furnace and tank piping.

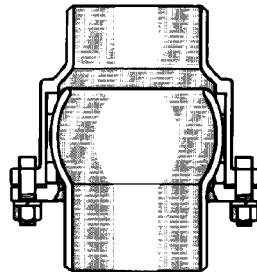

Barco Ball Joint

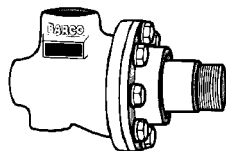

Barco Rotary Joints handle single flow or syphon flow applications using steam, hot oil, air, gas or chemicals. Steelmaking applications include: trunnion rings, pinch roll cooling and straightener rolls on continuous casting machines, scrubbing lines and run out table roll cooling.

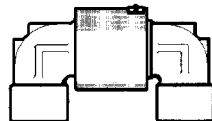

Barco Swivel Joints with positive, long-lasting Tri-Ring seal allow free swiveling under pressure. Efficient dust seals protect seal area against dirt and other foreign particles. Wide-spaced bearing area permits heavier end loads, smooth turning. Low torque is assured throughout entire pressure range.

PERFECTING Duff-Norton
Ansteel

Rotary Union® Joints

The Perfecting Rotary Union® joint is the finest rotating sealing mechanism.

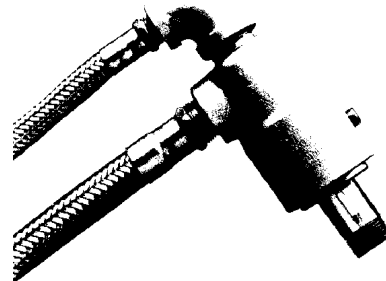

**COPPER FITTINGS
FLARED FOR WATER SERVICE**

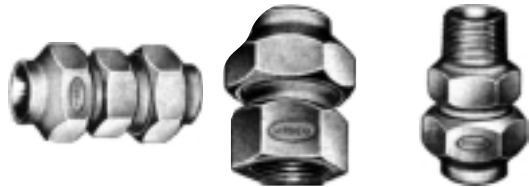

| Size | Coupling CXC | | Adapter CXF | | Adapter CXM | |
|-------|-----------------|-------|----------------|-------|----------------|-------|
| | Fig No | Price | Fig No | Price | Fig No | Price |
| 3/8 | 14283 | | 14298 | | 14313 | |
| 1/2 | 14285 | | 14301 | | 14316 | |
| 3/4 | 14287 | | 14303 | | 14318 | |
| 1 | 14290 | | 14305 | | 14320 | |
| 1 1/4 | 14291 | | 14308 | | 14322 | |
| 1 1/2 | 14293 | | 14310 | | 14324 | |
| 2 | 14295 | | 14311 | | 14327 | |

| Size | 90° Elbow CXC | | 90° Elbow CXM | | Tee CXCXC | |
|-------|------------------|-------|------------------|-------|--------------|-------|
| | Fig No | Price | Fig No | Price | Fig No | Price |
| 3/8 | 14329 | | 33697 | | 14343 | |
| 1/2 | 14332 | | 33698 | | 14345 | |
| 3/4 | 14334 | | 33699 | | 14349 | |
| 1 | 14335 | | 33700 | | 14352 | |
| 1 1/4 | 14337 | | 33701 | | 14354 | |
| 1 1/2 | 14339 | | 33702 | | 14357 | |
| 2 | 14341 | | 33703 | | 14360 | |

**COPPER FITTINGS
CAST FLANGED FITTINGS FOR COPPER TUBING OR BRASS PIPE**



**COMPANION
FLANGE**

| Size | Fig No | Price |
|-------|--------|-------|
| 1/2 | 14239 | |
| 3/4 | 14241 | |
| 1 | 14244 | |
| 1 1/4 | 14249 | |
| 1 1/2 | 14255 | |
| 2 | 14257 | |
| 2 1/2 | 14259 | |
| 3 | 14261 | |
| 4 | 14264 | |
| 5 | 14266 | |
| 6 | 14267 | |
| 8 | 33679 | |

* Class 125 provided unless class 150 specified.



90° Elbow



45° Elbow



Reducer



Cross



Tee



Threaded Companion
Flange

ALL AVAILABLE FOR QUICK DELIVERY!

CHROME PLATED BRASS FITTINGS

CHROME PLATED BRASS NIPPLES



| SIZE | FIG. NO. | PRICE |
|-------------|----------|-------|
| 3/8 X Close | 2551 | |
| 3/8 x 1 1/2 | 2552 | |
| 3/8 x 2 | 34737 | |
| 3/8 x 2 1/2 | 2554 | |
| 3/8 x 3 | 2555 | |
| 3/8 x 3 1/2 | 2556 | |
| 3/8 x 4 | 2557 | |
| 3/8 x 4 1/2 | 2558 | |
| 3/8 x 5 | 2559 | |
| 3/8 x 5 1/2 | 2560 | |
| 3/8 x 6 | 2561 | |
| 3/8 x 12 | 12628 | |
| 3/8 x 18 | 12631 | |
| 3/8 x 24 | 12636 | |
| 1/2 x Close | 2569 | |
| 1/2 x 1 1/2 | 2570 | |
| 1/2 x 2 | 2571 | |
| 1/2 x 2 1/2 | 2572 | |
| 1/2 x 3 | 2573 | |
| 1/2 x 3 1/2 | 2574 | |
| 1/2 x 4 | 2575 | |
| 1/2 x 4 1/2 | 2576 | |
| 1/2 x 5 | 2577 | |
| 1/2 x 5 1/2 | 2578 | |
| 1/2 x 6 | 2579 | |
| 1/2 x 12 | 33961 | |
| 1/2 x 15 | 33962 | |
| 1/2 x 18 | 26396 | |
| 3/4 x Close | 2580 | |
| 3/4 x 2 | 2582 | |
| 3/4 x 4 | 2586 | |
| 3/4 x 5 | 2588 | |
| 3/4 x 6 | 2590 | |

CHROME PLATED BRASS PIPE



| SIZE | FIG. NO. | PRICE |
|------------|----------|-------|
| 3/8 X 6 FT | 12657 | |
| 1/2 X 6 FT | 12659 | |

A complete line of chrome plated valves and fittings are available up to 2"

CHROME PLATED



BRASS 90° ELBOW

| SIZE | FIG. NO. | PRICE |
|------|----------|-------|
| 3/8" | 12704 | |
| 1/2" | 2546 | |
| 3/4" | 2547 | |

CHROME PLATED

BRASS STREET 90° ELBOW



| SIZE | FIG. NO. | PRICE |
|------|----------|-------|
| 1/2" | 2533 | |
| 3/8" | 2532 | |

CHROME PLATED BRASS TEE



| SIZE | FIG. NO. | PRICE |
|------|----------|-------|
| 3/8 | 2534 | |
| 1/2 | 2535 | |

CHROME PLATED BRASS BUSHING



| SIZE | FIG. NO. | PRICE |
|-----------|----------|-------|
| 1/2 X 3/8 | 12645 | |
| 3/4 X 1/2 | 12647 | |
| 3/8 X 1/4 | 40030 | |

CHROME PLATED BRASS CAP



| SIZE | FIG. NO. | PRICE |
|------|----------|-------|
| 1/2 | 2539 | |

CHROME PLATED BRASS 45° ELBOW



| SIZE | FIG. NO. | PRICE |
|------|----------|-------|
| 3/8 | 2548 | |
| 1/2 | 2549 | |
| 3/4 | 2550 | |

CHROME PLATED BRASS STREET 45° ELBOW



| SIZE | FIG. NO. | PRICE |
|------|----------|-------|
| 3/8 | 2530 | |
| 1/2 | 2531 | |

CHROME PLATED BRASS UNION

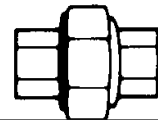

| SIZE | FIG. NO. | PRICE |
|------|----------|-------|
| 3/8 | 2540 | |
| 1/2 | 2541 | |

CHROME PLATED BRASS COUPLING



| SIZE | FIG. NO. | PRICE |
|-----------|----------|-------|
| 3/8 | 2542 | |
| 1/2 | 2543 | |
| 3/4 | 2544 | |
| 1/2 X 3/8 | 5901 | |
| 3/4 X 1/2 | 5902 | |

CHROME PLATED BRASS PLUG



| SIZE | FIG. NO. | PRICE |
|------|----------|-------|
| 1/2 | 2537 | |

HOSE FITTINGS

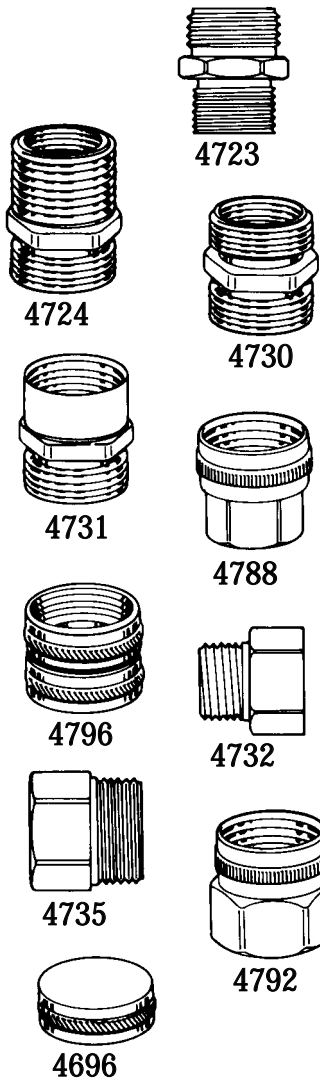

| SIZE | NYLON | | BRASS | |
|--|---------|-------|----------|-------|
| | FIG. NO | PRICE | FIG. NO. | PRICE |
| 3/4" Male Hose X 1/2" MIP | 31617 | | 4723 | |
| 3/4" Male Hose X 3/4" MIP X 1/2" FIP | | | 4724 | |
| 3/4" Male Hose X 3/4" Male Hose | 31618 | | 4739 | |
| 3/4" Male Hose X 3/4" FIP | 31623 | | 4731 | |
| Swivel Type 3/4" Fem Hose X 1/2" FIP | | | 4788 | |
| Swivel Type 3/4" Fem Hose X 3/4" Fem Hose | | | 4796 | |
| 3/4" Fem Hose X 1/2" MIP | | | 4732 | |
| 3/4" Fem Hose X 3/4" MIP X 1/2" FIP | 31627 | | 4735 | |
| Swivel Type 3/4" Fem Hose X 3/4" FIP | | | 4792 | |
| Brass Hose Cap. Fits standard 3/4" hose fittings | | | 4696 | |
| 3/4" Male hose x 1/2" FIP | | | 4730 | |
| 3/4" Male hose x 1/2" Copper Adapter | | | 73498 | |

**Brass Siamese
Hose
Connection**

| FIG. NO. | PRICE |
|----------|-------|
| 4818 | |

**Brass Adjustable Hose
Nozzle**

| FIG. NO. | PRICE |
|----------|-------|
| 4742 | |

**Plastic Siamese
Hose Connection
with Shut-offs**

| FIG. NO. | PRICE |
|----------|-------|
| 49358 | |

**Pistol Grip
Hose Nozzle**

| FIG. NO. | PRICE |
|----------|-------|
| 4760 | |

**Brass Plain Hose Coupling
Rod Stock Brass**

| DESC | SIZE | FIG. NO. | PRICE |
|--------|------|----------|-------|
| MALE | 1/2" | 4811 | |
| MALE | 5/8" | 4814 | |
| MALE | 3/4" | 4820 | |
| FEMALE | 1/2" | 4798 | |
| FEMALE | 5/8" | 4802 | |
| FEMALE | 3/4" | 4805 | |

GARDEN HOSE

**All
Purpose
Garden Hose**

| SIZE | FIG. NO. | PRICE |
|-----------|----------|-------|
| 5/8 x 25' | 38045 | |
| 5/8 x 50' | 11429 | |

**Rubber Hose
Washer**

| FIG. NO. | PRICE |
|----------|-------|
| 14757 | |

**Filter Hose
Washer**

| FIG. NO. | PRICE |
|----------|-------|
| 14759 | |

**Hose Coupler -
Clinch type,
Wrought Brass**

| SIZE | FIG. NO. | PRICE |
|------|----------|-------|
| 5/8" | 4865 | |
| 3/4" | 4868 | |

CONTRACTOR HOSE

**Contractors Rubber Water
Hose. Heavy duty black
EPDM rubber. Heavy brass
octagon coupling. 150 LB
working pressure.**

| SIZE | FIG. NO. | PRICE |
|------------------|----------|-------|
| 3/4 x 25FT Coil | 11432 | |
| 3/4 x 50FT Coil | 11434 | |
| 3/4 x 100FT Coil | 40204 | |

GAS PIPE AND FITTINGS

POLYETHYLENE GAS PIPE

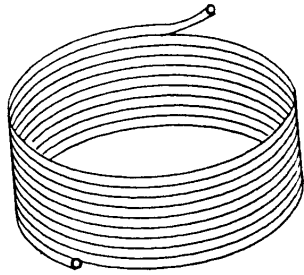

Design pressure may not exceed 100 psig for plastic pipe used in distribution systems. May not be used where operating temperatures of the pipe will be below minus 20°

F or above 140°F.

Plastic Polyethylene pipe has a mirror smooth interior. Excellent flow properties is maintained throughout its service life due to its excellent chemical and abrasion resistance.

| SIZE | NOMINAL OD | SDR | MIN WALL | WT PER 100' | LENGTH | FIG. NO. | PRICE |
|-------|------------|------|----------|-------------|--------|----------|-------|
| 3/4 | 1.050 | 11.0 | .095 | 11.6 | 150FT | 15446 | |
| 1 | 1.315 | 11.0 | .119 | 18.3 | 150FT | 15448 | |
| 1 | 1.315 | 11.0 | .119 | 18.3 | 500FT | 15450 | |
| 1 1/4 | 1.660 | 11.0 | .151 | 27.9 | 150FT | 15451 | |
| 1 1/2 | 1.660 | 11.0 | .173 | 38.3 | 150FT | 15454 | |
| 1 1/2 | 1.660 | 11.0 | .173 | 38.3 | 500FT | 15455 | |
| 2 | 2.375 | 11.0 | .216 | 59.7 | 100FT | 15456 | |
| 2 | 2.375 | 11.0 | .216 | 59.7 | 200FT | 15457 | |
| 2 | 2.375 | 11.0 | .216 | 59.7 | 500FT | 15458 | |

LOCATOR TAPE

Bury locator tape 6" below grade directly above polyethylene pipe. The metallic tape allows easy location of plastic pipe with detector. 1000' rolls.

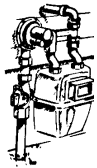

| Descr | Fig. No. | Price |
|--------------------|----------|-------|
| Blue Metallic | 63671 | |
| Purple Non-Metalic | 63672 | |

GAS COUPLING

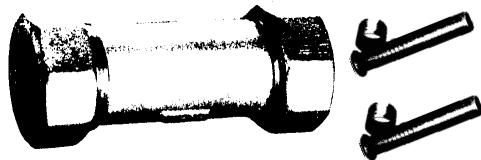

| SIZE | FIG. NO. | PRICE |
|-------|----------|-------|
| 3/4 | 38824 | |
| 1 | 38825 | |
| 1 1/4 | 38826 | |
| 1 1/2 | 38827 | |
| 2 | 38828 | |

WRAPPING TAPE FOR GAS LINES

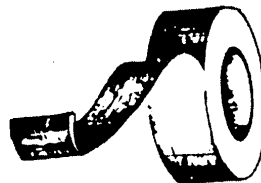

To wrap pipe & fittings

| FIG. NO. | PRICE |
|----------|-------|
| 45480 | |

GAS ADAPTER

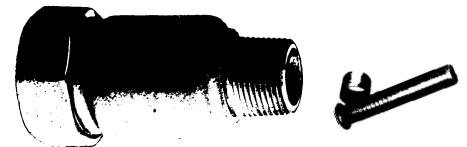

| SIZE | FIG. NO. | PRICE |
|-------|----------|-------|
| 3/4 | 48431 | |
| 1 | 44582 | |
| 1 1/4 | 41009 | |
| 1 1/2 | 41009 | |
| 2 | 44548 | |

GAS VALVES

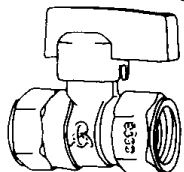

1/2" - 3/4"

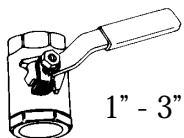

1" - 3"

| SIZE | FIG. NO. | PRICE |
|-------|----------|-------|
| 1/2 | 50802 | |
| 3/4 | 50803 | |
| 1 | 47873 | |
| 1 1/4 | 6349 | |
| 1 1/2 | 6352 | |
| 2 | 49737 | |
| 2 1/2 | 50788 | |
| 3 | 50789 | |

GAS TAPE PRIMER

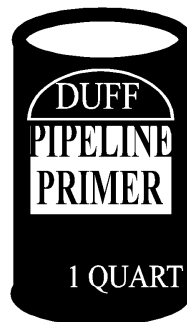

1 QUART

| FIG. NO. | PRICE |
|----------|-------|
| 45481 | |

YELLOW GAS LINE TEFLON THREAD SEAL TAPE

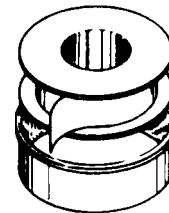

| FIG. NO. | PRICE |
|----------|-------|
| 61358 | |

Designed for gas lines of all types...natural gas, propane and butane lines. Meets gas company standards world wide. Full density (1.6) and also 4 mils thick, makes this the heaviest tape available. Seals threads easily and quickly with confidence. Has a temperature range of -450F to +550F. Exceeds Mil Spec, T-27730A. UL listed.





Gastite is an American Gas Association design-certified fuel gas piping system. It utilizes corrugated, semi-rigid stainless steel tubing (CSST) and fully-integrated, all metal components, including fittings, multiport manifolds, pressure regulators, shut-off valves, termination outlets and protection devices. Convenient tools to facilitate fabrication and installation are also available. Gastite is a reliable, cost-effective, and flexible gas piping material that can be installed in all modes of new construction, as well as rehabilitation and retrofit.

Gastite piping material offers important advantages: improved safety, enhanced installation flexibility, and substantial labor savings.

ELIMINATES BLACK IRON HASSELS:

- NO THREADING OF PIPE
- NO HEAVY EQUIPMENT
- FAR FEWER FITTINGS
- FAR FEWER POTENTIAL LEAKS
- LIGHTWEIGHT
- EASY TO CARRY

| | SIZE | FIG. NO. | PRICE |
|--|------------|----------|-------|
| CONVOLUTED STAINLESS STEEL TUBING (plastic covered) | | | |
|  | 1/2 X 250' | 71486 | |
| | 3/4 X 250' | 71487 | |
| | 1 X 150' | 71488 | |

| | SIZE | FIG. NO. | PRICE |
|---|------|----------|-------|
| BRASS MECHANICAL JOINT FITTING (MALE ADAPTER) | | | |
|  | 1/2 | 71489 | |
| | 3/4 | 71490 | |
| | 1 | 71491 | |
| (SPLIT RINGS) | | | |
| | 1/2 | 71500 | |
| | 3/4 | 71501 | |
| | 1 | 71502 | |

| | SIZE | FIG. NO. | PRICE |
|---|------|----------|-------|
| BRASS TERMINATION OUTLET | | | |
|  | 1/2 | 71492 | |
| | 3/4 | 71493 | |
| | 1 | 71494 | |

| | SIZE | FIG. NO. | PRICE |
|--|------|----------|-------|
| 90 DEGREE TERMINATION OUTLETS | | | |
|  | 3/8 | 73767 | |
| | 1/2 | 73768 | |

| | SIZE | FIG. NO. | PRICE |
|---|---------------|----------|-------|
| TERMINATION OUTLET MOUNTING BRACKET KIT | | | |
|  | 3/8, 1/2, 3/4 | 71495 | |

| | SIZE | FIG. NO. | PRICE |
|---|---------------|----------|-------|
| STEP DOWN "T" FITTINGS | | | |
|  | 3/4 - 1/2 NPT | 71503 | |
| | 1 - 3/4 NPT | 71504 | |

| | SIZE | FIG. NO. | PRICE |
|---|--------------|----------|-------|
| STRIKER PLATES | | | |
|  | 3 X 12" FULL | 71498 | |
| | 3 X 7" HALF | 71499 | |

| | SIZE | FIG. NO. | PRICE |
|--|-------------|----------|-------|
| STARTER TOOL KIT (Sm. cutter, 3 sockets, lg. rolls) | | | |
| | 1/2, 3/4, 1 | 72650 | |

| | SIZE | FIG. NO. | PRICE |
|---|-----------------|----------|-------|
| TUBING CUTTERS | | | |
|  | Cutter | 13588 | |
| | Cutter Wheels | 13654 | |
| | Rollers 3/8-1/2 | 71505 | |
| | Rollers 3/4-1 | 71506 | |

| | SIZE | FIG. NO. | PRICE |
|---|------|----------|-------|
| SOCKET FLARING TOOL | | | |
|  | 1/2 | 71507 | |
| | 3/4 | 71508 | |
| | 1 | 71509 | |

| | SIZE | FIG. NO. | PRICE |
|---|------|----------|-------|
| SHUT-OFF VALVES | | | |
|  | 1/2 | 50802 | |
| | 3/4 | 50803 | |
| | 1 | 47873 | |

| | DESCRIPTION | FIG. NO. | PRICE |
|---|-------------|----------|-------|
| REGULATORS | | | |
|  | NATURAL | 71496 | |
| | PROPANE | 71497 | |



FLEXIBLE COUPLINGS

FOR SEWER OR DRAIN WASTE AND VENT PIPE

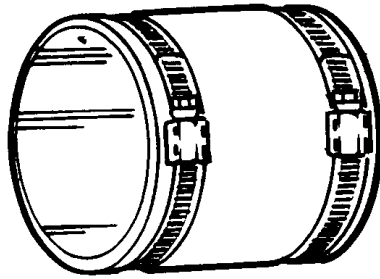

Used to connect all type of in-house and sewer connections, drain waste vent, house to main, roof drains, repairs and increaser or reducer connection. Made of tough elastomeric polyvinyl chorlide (PVC). Strong resilient and unaffected by soil conditions. Resistant to chemicals, ultra violet rays, fungus growth and normal sewer gas. Leak proof, rust proof.

Couplings are made to connect plastic, cast iron, service, extra heavy, no-hub, asbestos cement, clay, concrete, steel, fibre and ductile iron or tubular pipe. Only takes minutes to make connection!
SBC, BOCA, UPC AND CSA CODES

FOR CORRUGATED PIPE

| OEM # | SIZE | FIG. NO. | PRICE |
|---------|------|----------|-------|
| 1070-33 | 3X3 | 73495 | |
| 1070-44 | 4X4 | 44555 | |
| 1070-66 | 6X6 | 44556 | |
| 1070-88 | 8X8 | 73496 | |

1056 SERIES - C.I., Plastic to C.I., Plastic

| OEM # | SIZE | FIG. NO. | PRICE |
|-----------|---------------|----------|-------|
| 1056-125 | 1 1/4 x 1 1/4 | 7795 | |
| 1056-150 | 1 1/2 x 1 1/4 | 7800 | |
| 1056-150 | 1 1/2 x 1 1/2 | 7802 | |
| 1056-215 | 2 x 1 1/2 | 7804 | |
| 1056-22 | 2 x 2 | 7805 | |
| 1056-315 | 3 x 1 1/2 | 21324 | |
| 1056-32 | 3 x 2 | 7807 | |
| 1056-33 | 3 x 3 | 7809 | |
| 1056-415 | 4 x 1/12 | 36041 | |
| 1056-42 | 4 x 2 | 19821 | |
| 1056-43 | 4 x 3 | 7811 | |
| 1056-44 | 4 x 4 | 7813 | |
| 1056-53 | 5 x 3 | 36040 | |
| 1056-54 | 5 x 4 | 36042 | |
| 1056-55 | 5 x 5 | 7816 | |
| 1056-63 | 6 x 3 | 36043 | |
| 1056-64 | 6 x 4 | 7820 | |
| 1056-65 | 6 x 5 | 36044 | |
| 1056-66 | 6 x 6 | 7832 | |
| 1056-84 | 8 x 4 | 36045 | |
| 1056-86 | 8 x 6 | 7836 | |
| 1056-88 | 8 x 8 | 18039 | |
| 1056-10-8 | 10 x 8 | 36046 | |
| 1056-1010 | 10 x 10 | 7838 | |
| 1056-1210 | 12 x 10 | 36047 | |
| 1056-1212 | 12 x 12 | 7841 | |
| 1056-1512 | 15 x 12 | 36048 | |
| 1056-1515 | 15 x 15 | 36049 | |
| 1056-1815 | 18 x 15 | | |
| 1056-1818 | 18 x 18 | | |
| 1056-2121 | 21 x 21 | | |
| 1056-2424 | 24 x 24 | | |
| 1056-2727 | 27 x 27 | | |

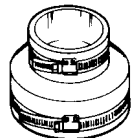

1002 SERIES - Clay to C.I. or Plastic

| OEM # | SIZE | FIG. NO. | PRICE |
|-----------|-------|----------|-------|
| 1002-43 | 4x3 | 36026 | |
| 1002-44 | 4x4 | 7770 | |
| 1002-54 | 5x4 | 36027 | |
| 1002-55 | 5x5 | 36028 | |
| 1002-64 | 6x4 | 7787 | |
| 1002-65 | 6x5 | 36029 | |
| 1002-66 | 6x6 | 7790 | |
| 1002-86 | 8x6 | 7792 | |
| 1002-88 | 8x8 | 36030 | |
| 1002-10-8 | 10x8 | 36031 | |
| 1002-1010 | 10x10 | 36032 | |
| 1002-1212 | 12x12 | 36034 | |

FERNCO EXPANSION JOINTS

For trouble-free vertical installations

| SIZE | PART NO. |
|--------|----------|
| 1-1/2" | XJ150 |
| 2" | XJ2 |
| 3" | XJ3 |
| 4" | XJ4 |

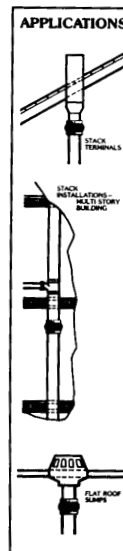

- Unique one-piece construction.
- No sliding parts to malfunction.
- No packing to jam, freeze or leak.
- Maintenance-free.

Thermal Expansion Table for P.V.C. Pipe

| Temperature Change Degrees F | Column 1 Expansion Per Ft. (Inches) | Column 2 Limit Per Expansion Joint (Ft.) |
|------------------------------|-------------------------------------|--|
| 50° | .0174 | 86 |
| 60° | .0209 | 71 |
| 70° | .0244 | 61 |
| 80° | .0278 | 54 |
| 100° | .0348 | 43 |

Fernco Expansion Joints will accommodate a maximum of 1-1/2" expansion and 1/2" contraction from a normal position. For A.B.S. pipe use 2 x value of Column 1 and 1/2 x value of Column 2.

SPECIAL FLEX FITTINGS

DRAIN CONNECTION

- Trap to drain

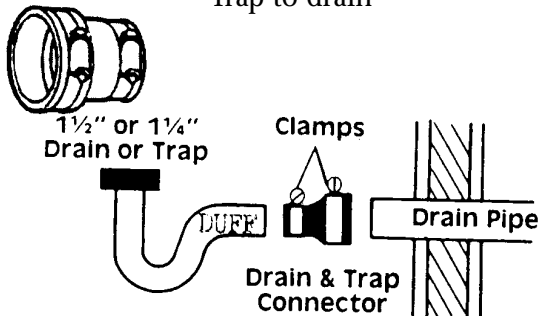

| DESCR | FIG. NO. | PRICE |
|--|----------|-------|
| Connects 1 1/4 or 1 1/2 trap to 2" IPS or PVC pipe | 25205 | - |
| Connects 1 1/4" or 1 1/2" IPS or PVC or 2" Copper tube | 36051 | |

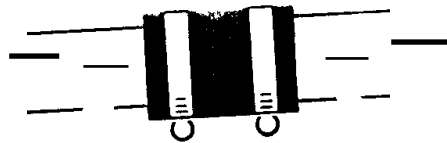

CAST IRON PIPE TO COPPER TUBE CONNECTION

| CAST IRON | COPPER | FIG. NO. | PRICE |
|-----------|--------|----------|-------|
| 2" | 1 1/2" | 51186 | |
| 1 1/2" | 1 1/2" | 51187 | |
| 2" | 2" | 51188 | |

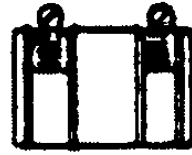

DRAIN CONNECTION TRAP TO TUBE DRAIN

1 1/4 or 1 1/2 trap to 1 1/4 or 1 1/2 tube or pipe

| FIG. NO. | PRICE |
|----------|-------|
| 49598 | |



FLEXIBLE RUBBER J BEND 1 1/4 or 1 1/2 drain pipe to 1 1/2 drain pipe or tubular trap

| FIG. NO. | PRICE |
|----------|-------|
| 51185 | |



FLEX TEE

| SIZE | FIG. NO. | PRICE |
|--------|----------|-------|
| 1 1/2" | 47731 | |
| 2" | 47732 | |
| 3" | 47733 | |
| 4" | 47734 | |

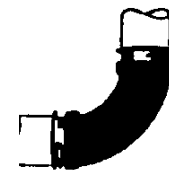

FLEX 90

| SIZE | FIG. NO. | PRICE |
|--------|----------|-------|
| 1 1/2" | 47735 | |
| 2" | 47736 | |
| 3" | 47737 | |
| 4" | 47738 | |

BUSHINGS FOR FLEX

| SIZE | FIG. NO. | PRICE |
|---------|----------|-------|
| 2X1 1/2 | 61340 | |
| 3X2 | 61341 | |
| 4X3 | 61342 | |

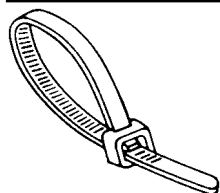

STANDARD SELF-LOCKING WIRE TIES

Self-locking wire ties secure bundles, cable and harnesses fast! The bent tip features quick self-locking head. One piece molded design of opaque nylon

and can be used in temperatures ranging from -40°F to 185°F.

| SIZE | FIG. NO. | PRICE |
|------|----------|-------|
| 4" | 18152 | |
| 6" | 38926 | |
| 11" | 38927 | |
| 14" | 38925 | |

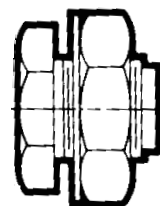

BRASS BULKHEAD FITTING

| SIZE | FIG. NO. | PRICE |
|------|----------|-------|
| 1/8 | 66824 | |
| 1/4 | 37851 | |
| 3/8 | 66825 | |
| 1/2 | 37852 | |

CAST IRON SPECIALTIES
CLOSET BENDS (IDEAL BENDS)

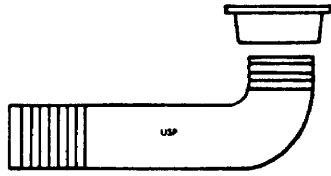

PLAIN

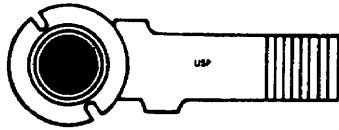

TAPPED

| SIZE - 4" X 6" X 16" | | |
|----------------------|--------|-------|
| Size | Fig No | Price |
| NONE | 7133 | |
| SINGLE | 7135 | |
| DOUBLE | 7136 | |

*Please specify number of tappings and side for tapping.

TO DETERMINE RIGHT OR LEFT HAND:

TRAPS and CLOSET BENDS:
 Place in regular position with hub or inlet end nearest you.

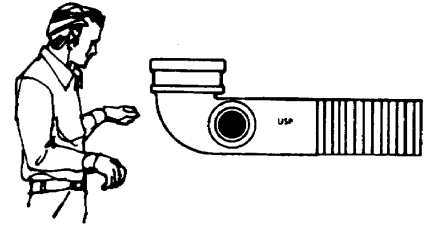

USP-366

Right Hand Shown

CLOSET FLANGES



CAST IRON STRAIGHT FLANGE

| Size | Fig No | Price |
|-----------|--------|-------|
| Shallow | 7362 | |
| 4 x 2 | 7355 | |
| 4 x 2 1/2 | 7357 | |
| 4 x 4 | 7358 | |
| 4 x 6 | 7360 | |



CAST IRON OFFSET FLANGE

| Size | Fig No | Price |
|------|--------|-------|
| 4 | 7364 | |



No Caulk Closet Flange

| Size | Fig No | Price |
|-------|--------|-------|
| 4 x 2 | 7443 | |
| 4 x 4 | 7445 | |

INSTALLS IN SECONDS
TWO SIMPLE STEPS:

1. Place instant set ring over closet bend.
2. Position ring & tighten bolts securely.



Before you're flooded with problems call

610-275-4453



When ordering the No Caulk Closet Flange, don't forget to order grease!

CAST IRON SPECIALTIES

DUFF SCREWED HUB INSERTABLE FITTINGS

KAFER FITTINGS

Eliminate the need for extra fittings. Easily installed. The ideal fittings for installations in an existing stack or line.

SAMPLE INSTALLATION:

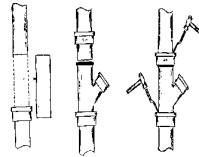

Sisson Joint



| Size | Fig No | Price |
|------|--------|-------|
| 4" | 7386 | |

Kafer Wye



| Size | Fig No | Price |
|-------|--------|-------|
| 4 x 3 | 7373 | |
| 4 | 7377 | |

Kafer Tee



| Size | Fig No | Price |
|------|--------|-------|
| 4" | 7382 | |

Straight Kafer

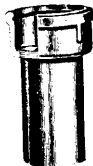

| Size | Fig No | Price |
|------|--------|-------|
| 2" | 7365 | |
| 3" | 7367 | |
| 4" | 7368 | |

REPAIR PLATE

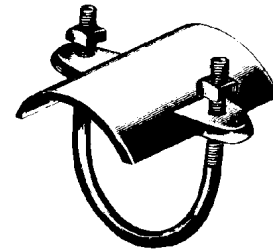

To repair holes, cracks, etc. in soil pipe. Complete with "U"

| Size | Fig No | Price |
|------|--------|-------|
| 2 | 7392 | |
| 3 | 7393 | |
| 4 | 7394 | |
| 5 | 7395 | |
| 6 | 7396 | |

GASKET FOR SADDLES & PLATES



| Size | Fig No | Price |
|--------------|--------|-------|
| Single Sheet | 44323 | |
| Box | 14672 | |

SADDLE FITTINGS

To make corrections to existing lines without cutting off the pipe. Complete with "U" bolt.

HUB SADDLE TEE



| Size | Fig No | Price |
|-------|--------|-------|
| 4 X 2 | - | |
| 4 X 3 | - | |
| 4 X 4 | - | |

HUB SADDLE WYE



| Size | Fig No | Price |
|-------|--------|-------|
| 4 X 4 | 7413 | |
| 6x4 | 7414 | |
| 8x4 | 51668 | |

TAPPED SADDLE TEE



| Size | Fig No | Price |
|-----------|--------|-------|
| 2 x 1 1/2 | 7415 | |
| 3 x 1 1/2 | 38848 | |
| 3 x 2 | 7416 | |
| 4 x 1 1/2 | 20882 | |
| 4 x 2 | 7417 | |
| 5 x 2 | - | |
| 6 x 2 | 41844 | |

CAST IRON SPECIALTIES

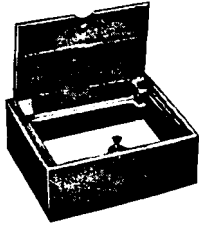

6X6 WATER BOX

| Fig No | Price |
|--------|-------|
| 7313 | |

6X6 WATER BOX LID

| Fig No | Price |
|--------|-------|
| 7314 | |

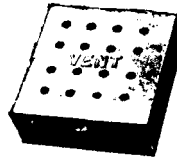

6X6 CAST IRON VENT BOX

| Fig No | Price |
|--------|-------|
| 7315 | |



CI MUSHROOM VENT CAP

| Size | Fig No | Price |
|------|--------|-------|
| 4" | 7323 | |
| 6" | 7324 | |

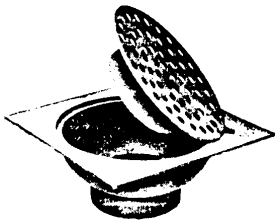

CI BELL TRAP

| Size | Fig No | Price |
|-------|--------|-------|
| 6X6 | 7325 | |
| 9X9 | 7326 | |
| 12X12 | 7327 | |

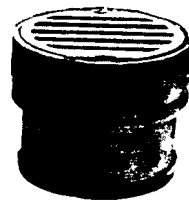

PHILADELPHIA VENT BOX
INSIDE CAULK

| Size | Fig No | Price |
|------|--------|-------|
| 4 | 7316 | |
| 6 | 7320 | |

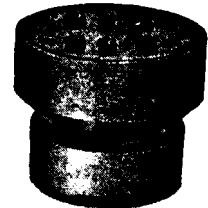

PHILADELPHIA VENT BOX
OUTSIDE CAULK

| Fig No | Price |
|--------|-------|
| 7318 | |

4" VENT BOX LID ONLY

| Fig No | Price |
|--------|-------|
| 7319 | |

PHILA VENT BOX LID SCREW (EA)

| Fig No | Price |
|--------|-------|
| 49250 | |



2" GALVANIZED
CATCH BASIN

| Fig No | Price |
|--------|-------|
| 7419 | |



When ordering vent boxes or catch basins, don't forget to order lead, oakum and/or T/S gaskets!

CAST IRON SPECIALTIES

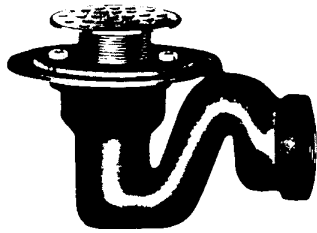

2" SHOWER TRAP WITH STRAINER

| Fig No | Price |
|--------|-------|
| 7450 | |

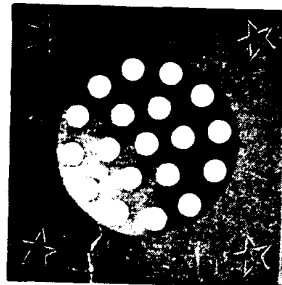

CI SQUARE CESSPOOL PLATE

| Size | Fig No | Price |
|-------|--------|-------|
| 6X6 | 7329 | |
| 8X8 | 7332 | |
| 10X10 | 7333 | |
| 12X12 | 7336 | |

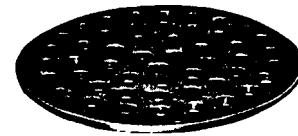

CI ROUND CESSPOOL PLATE

| Size | Fig No | Price |
|------|--------|-------|
| 5 | 7337 | |
| 6 | 7339 | |
| 7 | 7343 | |
| 8 | 7344 | |
| 10 | 7345 | |

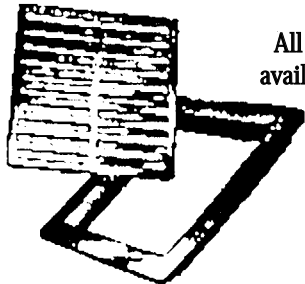

All sizes available!

Frame and Grate

| SIZE | FIG. NO. | PRICE |
|------|----------|-------|
| 12 | 60564 | |
| 18 | 60565 | |
| 24 | 60566 | |
| 58 | 60567 | |
| 160 | 60568 | |
| 185 | 60569 | |



Bar Grates for Soil Pipe

| SIZE | FIG. NO. | PRICE |
|------|----------|-------|
| 3" | 7527 | |
| 4" | 7530 | |
| 5" | 7532 | |
| 6" | 7533 | |
| 8" | 7537 | |

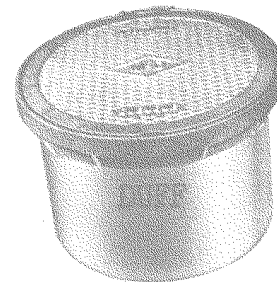

MANHOLE - no skid cover tread

| SIZE | FIG. NO. | PRICE |
|------|----------|-------|
| 8" | 17589 | |
| 12" | 17591 | |

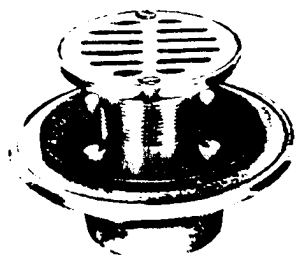

2" Floor & Shower Drain

| FIG. NO. | PRICE |
|----------|-------|
| 7449 | |

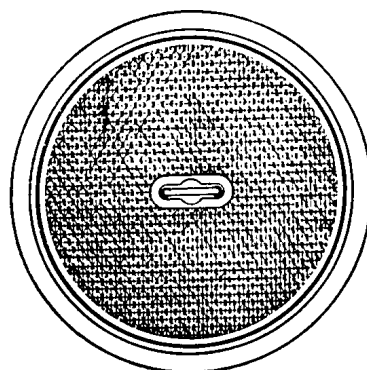

Round Manhole Cover

| SIZE | FIG. NO. | PRICE |
|------|----------|-------|
| 18 | 60562 | |
| 24 | 60563 | |



Chrome Plated Snap-in Drain - fits soil pipe!

| SIZE | FIG. NO. | PRICE |
|--------|----------|-------|
| 1 1/2" | 40940 | |
| 2" | 40941 | |
| 3" | 40942 | |
| 4" | 40943 | |

CAST IRON SPECIALTIES

BRASS CLEANOUT PLUGS

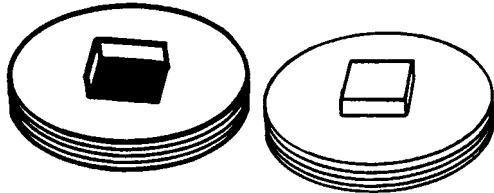

| | COUNTERSUNK | | RAISED HEAD | |
|-------|-------------|-------|-------------|-------|
| Size | Fig No | Price | Fig No | Price |
| 1 1/4 | 7461 | | 7458 | |
| 1 1/2 | 7466 | | 7465 | |
| 2 | 7468 | | 7467 | |
| 2 1/2 | 7471 | | 7469 | |
| 3 | 7473 | | 7472 | |
| 3 1/2 | 7475 | | 7474 | |
| 4 | 7477 | | 7476 | |
| 4 1/2 | 7479 | | 7478 | |
| 5 | 7481 | | 7480 | |
| 5 1/2 | 7483 | | 7482 | |
| 6 | 7485 | | 7484 | |

CLEANOUT

IBTS or Iron Body Tap Screw

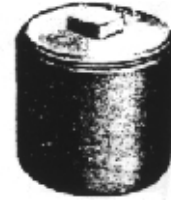

| Size | Fig No | Price |
|------|--------|-------|
| 2 | 7348 | |
| 3 | 7349 | |
| 4 | 7351 | |
| 5 | 7353 | |
| 6 | 7354 | |

LEAD FIT ALL PLUG

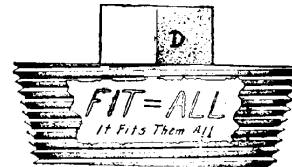

BRASS CLEANOUT PLUGS

All Duff brass plugs are machined to close tolerances to assure a perfect fit. Plugs are listed according to standard pipe sizes. To determine the proper size plug for a "cleanout", check the tapping size indicated on our catalog page for cleanouts, and order the corresponding size plug. Note: A 4" standard cleanout is tapped 3". A 4" extra heavy or full opening cleanout is tapped 3 1/2". Be sure to distinguish types when ordering.

| Size | Fig No | Price |
|-------|--------|-------|
| 1 1/2 | 17592 | |
| 2 | 17593 | |
| 2 1/2 | 17594 | |
| 3 | 17595 | |
| 3 1/2 | 17596 | |
| 4 | 17597 | |
| 4 1/2 | 17598 | |
| 5 | 17599 | |
| 5 1/2 | 17600 | |
| 6 | 38907 | |

SCALE TO DETERMINE PIPE SIZE OF CLEANOUT PLUGS



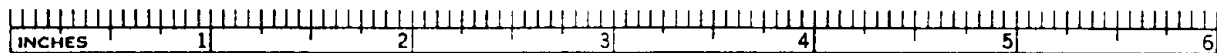





Upper scale is in inches
Lower scale is for diameter in pipe size

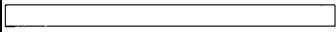

For additional information call: 610-275-4453 or Fax: 610-279-6299
Please call for current prices.

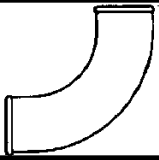
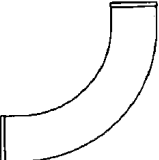
NO HUB CAST IRON SOIL PIPE AND FITTINGS

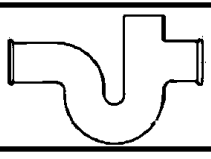
SERVICE WEIGHT NO-HUB PIPE AND FITTINGS

| | | 1 1/2" | 2" | 3" | 4" | | | |
|---|-----------------------|--------|-------|--------|-------|--------|-------|-------|
| | | Fig No | Price | Fig No | Price | Fig No | Price | |
|  | No Hub x 10' Length | 31235 | | 31236 | | 31237 | | 31704 |
|  | 1/4 Bend | 31239 | | 31240 | | 31241 | | 31242 |
|  | 1/6 Bend | - | | 30973 | | 30974 | | 30975 |
|  | 1/8 Bend | 31245 | | 31246 | | 31247 | | 31249 |
|  | 1/16 Bend | - | | 30976 | | 31243 | | 31244 |
|  | Short Sweep | - | | 30977 | | 31250 | | 30978 |
|  | Long Sweep | 30979 | | 30980 | | 31251 | | 30981 |
|  | P-Trap | 31018 | | 31272 | | 31273 | | 31019 |
|  | Single Vent Curb Trap | - | | - | | - | | 31020 |
|  | Plug | 31016 | | 31270 | | 31017 | | 31271 |

CAST IRON SOIL PIPE AND FITTINGS

SERVICE WEIGHT NO-HUB AND FITTINGS

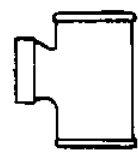
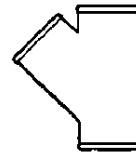
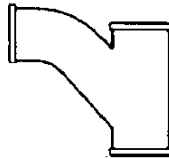
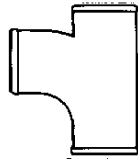

| SANITARY TEE | | COMBINATION WYE & 1/8 BEND | | WYE | | SINGLE TAPPED TEE | |
|--------------|--|----------------------------|--|-----|--|-------------------|--|
|--------------|--|----------------------------|--|-----|--|-------------------|--|

| SIZE | Fig No | Price | Fig No | Price | Fig No | Price | Fig No | Price |
|-----------|--------|-------|--------|-------|--------|-------|--------|-------|
| 1 1/2 | 30982 | | 30999 | | 30997 | | 31255 | |
| 2 | 30984 | | 31001 | | 31256 | | - | |
| 3 | 30987 | | 31264 | | 31258 | | - | |
| 4 | 30989 | | 31004 | | 27192 | | - | |
| 2 X 1 1/2 | 30983 | | 31000 | | - | | 30990 | |
| 3 X 1 1/2 | 30985 | | - | | - | | - | |
| 3 X 2 | 30986 | | 31002 | | 31257 | | 30969 | |
| 4 X 1 1/2 | - | | - | | - | | 30991 | |
| 4 X 2 | 30988 | | 31003 | | 31259 | | 30992 | |
| 4 X 3 | 31253 | | 31265 | | 31260 | | - | |

HUB & SPIGOT JOINING TOOLS

NO HUB TORQUE WRENCH

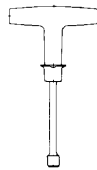

| Fig No | Price |
|--------|-------|
| 13134 | |

MODEL 234 JOINING TOOL

for 2", 3" and 4" joints.

With this tool you can make pipe joints either horizontally or vertically, join straight run fittings, join bends and sweeps and branch fittings with short laying lengths. It also can be used to separate any joints.

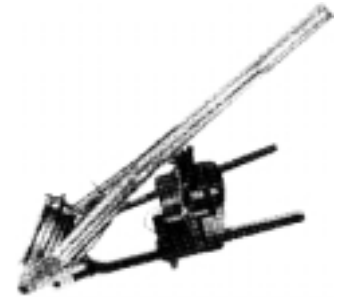

NO HUB COUPLING

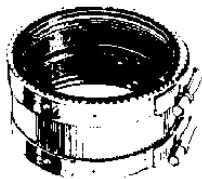

| Size | Fig No | Price |
|-----------|--------|-------|
| 1 1/2 | 28318 | |
| 2 | 7498 | |
| 3 | 7499 | |
| 4 | 7501 | |
| 5 | 7503 | |
| 6 | 7506 | |
| 8 | 7508 | |
| 10 | 28322 | |
| 2 X 1 1/2 | 28319 | |
| 3 X 2 | 28320 | |
| 4 X 3 | 28321 | |

MODEL 568 JOINING TOOL

for 5", 6" and 8" joints.

This tool is made for joining large diameter cast iron soil pipe with Tite Seal Gaskets.

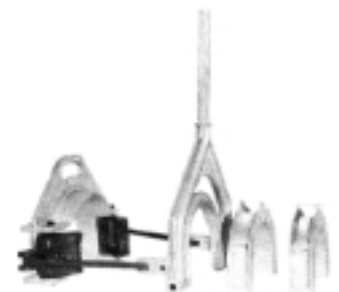



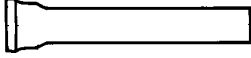
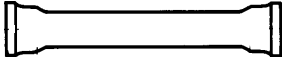

CAST IRON SOIL PIPE AND FITTINGS SERVICE WEIGHT HUB & SPIGOT

PIPE

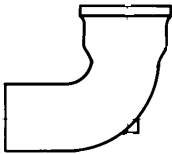
| | | 2" | | 3" | | 4" | | 6" | |
|--|------------|--------|-------|--------|-------|--------|-------|--------|-------|
| | | Fig No | Price | Fig No | Price | Fig No | Price | Fig No | Price |
| SINGLE HUB PIPE  | 42" LENGTH | 7011 | | 7012 | | 7013 | | 7014 | |
| | 10' LENGTH | 7007 | | 7008 | | 7009 | | 7010 | |
| | 5' LENGTH | 6999 | | 7000 | | 7001 | | 7002 | |
| DOUBLE HUB PIPE  | 5' LENGTH | 7003 | | 7004 | | 7005 | | 7006 | - |

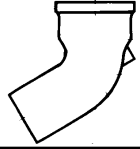
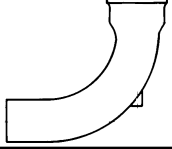
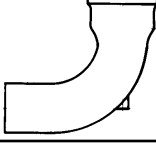
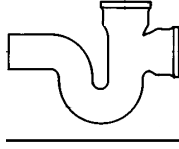
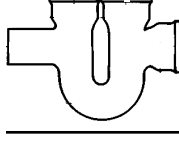
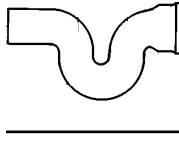
FITTINGS

| | | 2" | | 3" | | 4" | | 6" | | 8" | |
|---|-----------------------|--------|-------|--------|-------|--------|-------|--------|-------|--------|-------|
| | | Fig No | Price | Fig No | Price | Fig No | Price | Fig No | Price | Fig No | Price |
|  | 1/4 BEND | 7015 | | 7016 | | 7017 | | - | | - | |
|  | 1/8 BEND | 7019 | | 7020 | | 7021 | | 7022 | | 7023 | |
|  | 1/16 BEND | 7024 | | 7026 | | 7028 | | - | | 7033 | |
|  | LONG SWEEP | - | | 7125 | | 7126 | | 7127 | | - | |
|  | SHORT SWEEP | - | | 7129 | | 7130 | | 7131 | | - | |
|  | SINGLE VENT CURB TRAP | - | | - | | 7132 | | - | | - | |
|  | DOUBLE VENT CURB TRAP | - | | - | | 4911 | | - | | - | |
|  | RUNNING TRAP | - | | - | | 7107 | | - | | - | |
|  | P-TRAP | 7110 | | 7111 | | 7112 | | - | | - | |

CAST IRON SOIL PIPE & FITTINGS
SERVICE WEIGHT HUB & SPIGOT PIPE AND FITTINGS

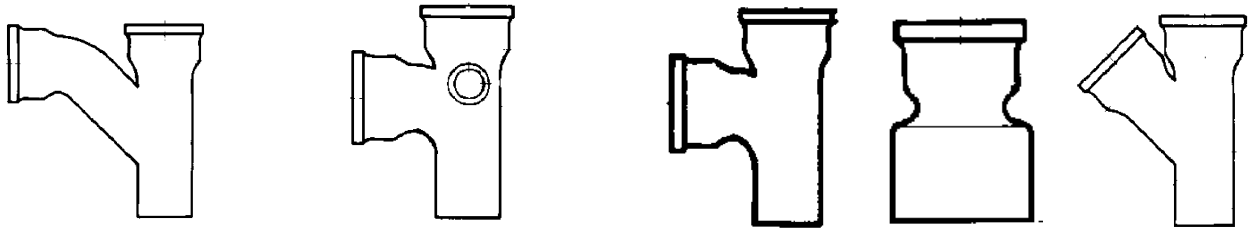

| SIZE | Combination Y & Eighth Bend | | Single Tapped Tee | | Double Tapped Tee | | Sanitary Tee | | Reducer | | Wye | |
|-------|-----------------------------|-------|-------------------|-------|-------------------|-------|--------------|-------|----------|-------|----------|-------|
| | FIG. NO. | PRICE | FIG. NO. | PRICE | FIG. NO. | PRICE | FIG. NO. | PRICE | FIG. NO. | PRICE | FIG. NO. | PRICE |
| 2 | 7036 | - | - | - | - | - | 31021 | - | - | - | 7113 | - |
| 3 | 7041 | - | - | - | - | - | 31022 | - | - | - | 7116 | - |
| 4 | 7043 | - | - | - | - | - | 31026 | - | - | - | 7117 | - |
| 6 | 7050 | - | - | - | - | - | 31034 | - | - | - | 7118 | - |
| 3 x 2 | 7042 | - | - | - | - | - | 7077 | - | 7085 | - | 7119 | - |
| 4 x 2 | 7048 | - | 7074 | - | 7076 | - | 7078 | - | 7087 | - | 7120 | - |
| 4 x 3 | 7046 | - | - | - | - | - | 7079 | - | 7090 | - | 7121 | - |
| 6 x 2 | - | - | - | - | - | - | 31031 | - | 7093 | - | - | - |
| 6 x 3 | 7054 | - | - | - | - | - | 31032 | - | 7097 | - | 7122 | - |
| 6 x 4 | 7059 | - | - | - | - | - | 7080 | - | 7100 | - | 7123 | - |

TITE SEAL GASKETS

(For use with Hub & Spigot Pipe)

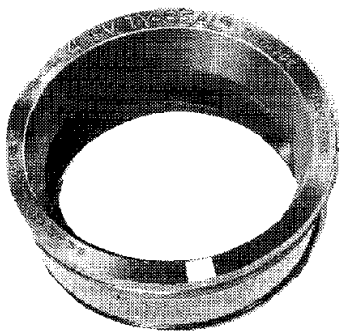

| Size | Fig No | Price |
|------|--------|-------|
| 2 | 7486 | |
| 3 | 7488 | |
| 4 | 7489 | |
| 5 | 7490 | |
| 6 | 7491 | |
| 8 | 7492 | |

TITE SEAL LUBRICANT

(QUART SIZE)



| Fig No | Price |
|--------|-------|
| 7496 | |

OAKUM

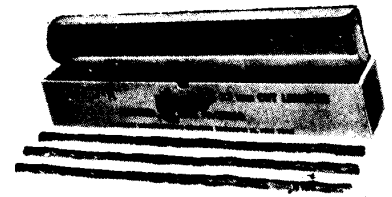

5 LB. BROWN OAKUM

| Fig No | Price |
|--------|-------|
| 7511 | |

10 LB. WHITE OAKUM

| | |
|------|--|
| 7514 | |
|------|--|

STRAINERS

SPECIAL BASKETS SCREENS AND MESH ALWAYS AVAILABLE

Perforated Metal and Mesh

AVAILABLE IN ALL MATERIALS

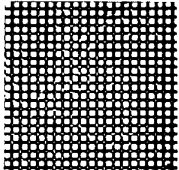
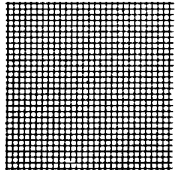
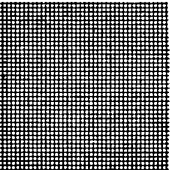
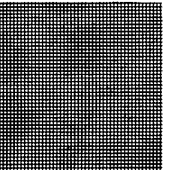
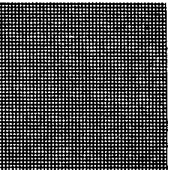
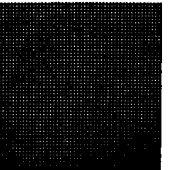
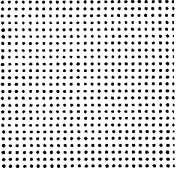
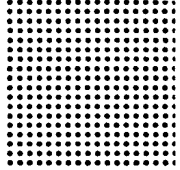
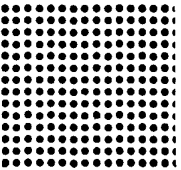
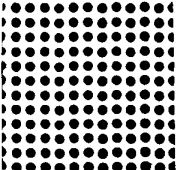
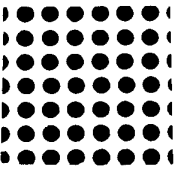
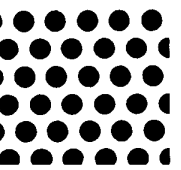
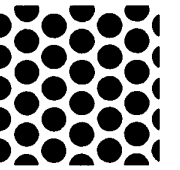
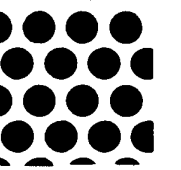
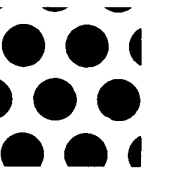
| | | | | | |
|---|---|---|---|---|--|
| <p>1/32" Openings</p>  <p>20 MESH (52% Open Area)</p> | <p>1/50" Openings</p>  <p>30 MESH (41% Open Area)</p> | <p>1/64" Openings</p>  <p>40 MESH (36% Open Area)</p> | <p>.009 Openings</p>  <p>60 MESH (31% Open Area)</p> | <p>.007 Openings</p>  <p>80 MESH (31% Open Area)</p> | <p>.005 Openings</p>  <p>100 MESH (30% Open Area)</p> |
| <p>MESH SIZES OTHER THAN SHOWN—AVAILABLE ON APPLICATION</p> | | | | | |
| <p>.027 Dia.</p>  <p>400 HOLES/SQ. IN. (23% Open Area)</p> | <p>.033 Dia. (1/32")</p>  <p>324 HOLES/SQ. IN. (28% Open Area)</p> | <p>.045 Dia. (3/64")</p>  <p>225 HOLES/SQ. IN. (36% Open Area)</p> | <p>.057 Dia. (1/16")</p>  <p>144 HOLES/SQ. IN. (37% Open Area)</p> | | |
| <p>1/10" Dia.</p>  <p>49 HOLES/SQ. IN. (39% Open Area)</p> | <p>1/8" Dia.</p>  <p>32 HOLES/SQ. IN. (40% Open Area)</p> | <p>5/32" Dia.</p>  <p>33 HOLES/SQ. IN. (62% Open Area)</p> | <p>3/16" Dia.</p>  <p>18 HOLES/SQ. IN. (50% Open Area)</p> | <p>1/4" Dia.</p>  <p>8 HOLES/SQ. IN. (40% Open Area)</p> | |
| <p>PERFORATIONS OTHER THAN THOSE SHOWN AVAILABLE—ALL OPEN AREAS APPROX.</p> | | | | | |

Replacement Screens & Baskets
For all Makes of "Y" & Basket Type Strainers

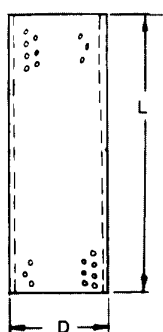

Style "D"

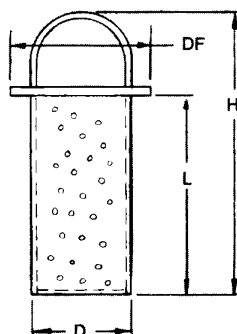

Style "E"

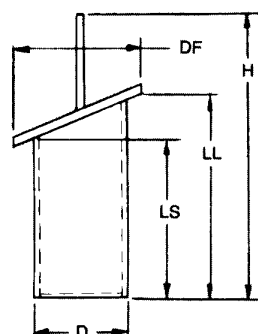

Style "F"

SPECIFY

1. Style
2. Material
3. Perforation & Mesh If Liner Is Required
4. All Lettered Dimensions Shown

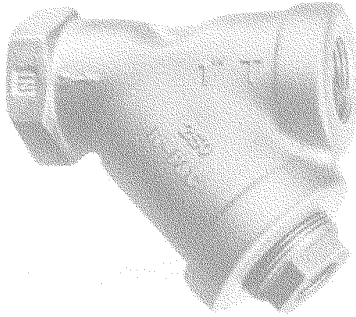

STRAINERS

CAST IRON OR BRONZE Y STRAINER - Offer complete protection to pumps, meters, traps, valves and similar expensive automatic equipment. Installation of a strainer before any automatic equipment will ensure trouble free service and avoid costly repairs of replacement so often caused by the introduction of foreign matter in pipe lines.

CAST IRON

BRONZE

| SIZE | FIG. NO. | PRICE | FIG. NO. | PRICE |
|-------|----------|-------|----------|-------|
| 1/4 | 17731 | | 5734 | |
| 3/8 | 17732 | | 5736 | |
| 1/2 | 17733 | | 17632 | |
| 3/4 | 17734 | | 17633 | |
| 1 | 17735 | | 17634 | |
| 1 1/4 | 17736 | | 17635 | |
| 1 1/2 | 17737 | | 17636 | |
| 2 | 17738 | | 17637 | |
| 2 1/2 | 17739 | | 5749 | |
| 3 | 17740 | | 5751 | |

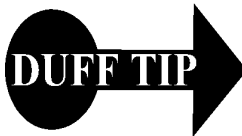

FOR MAXIMUM EFFICIENCY, ALWAYS USE BLOW DOWN VALVES TO CLEAN STRAINERS.

CAST IRON FLANGED Y STRAINERS - Offer complete protection to pumps, meters, traps, valves and similar expensive automatic equipment. Installation of a strainer before any automatic equipment will ensure trouble free service and avoid the costly repairs of replacement so often caused by the introduction of foreign matter in pipe lines.

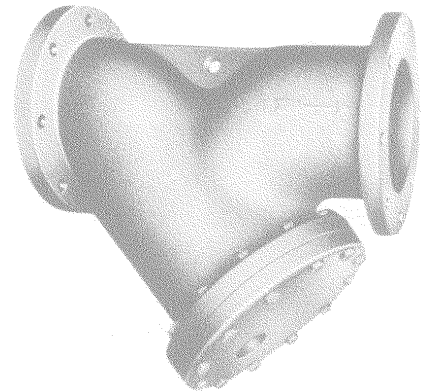

| SIZE | FIG. NO. | PRICE |
|-------|----------|-------|
| 2 | 44921 | |
| 2 1/2 | 17741 | |
| 3 | 17742 | |
| 4 | 17743 | |
| 6 | 17744 | |
| 8 | 50622 | |
| 10 | 50623 | |
| 12 | 50624 | |



ALL STRAINERS AVAILABLE IN STAINLESS STEEL, CAST STEEL OR PLASTIC!

TEMPORARY STRAINERS - are installed between companion flanges at startup time and later removed. Usually constructed in Stainless Steel, they are available in a large variety of perforations or mesh lining.

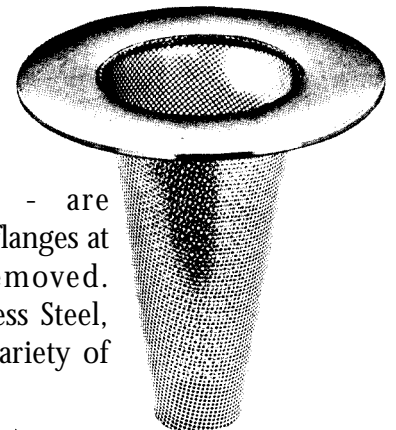

STRAINERS

DUPLEX AND SIMPLEX STRAINERS

DUPLEX BASKET STRAINERS

DUPLEX STRAINER (PLUG TYPE) - For sizes up to 8". It is the simplest, most economical and trouble-free design for a Duplex Strainer in smaller sizes. High quality, pressure rated plug valve with integral straining baskets. Switching flow from one basket to another is accomplished by moving the handle through a 90 degree arc. Because of the unique port design in the diverter plug, it is impossible for this operation to stop the flow. The entire switch operation takes less than 30 seconds. No tools required. Available in Iron, Bronze, Stainless Steel and Carbon Steel.

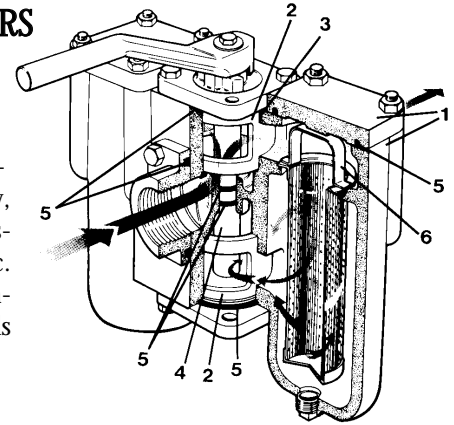

ALWAYS SPECIFY SERVICE, PRESSURE AND TEMPERATURE

SIMPLEX BASKET STRAINERS

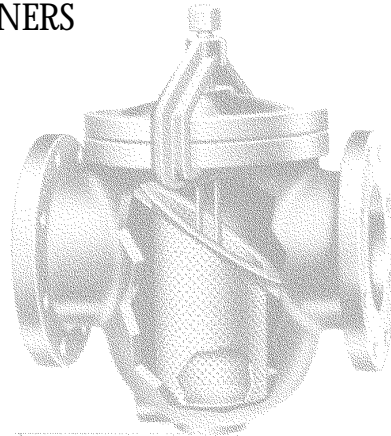

CLAMP TOP

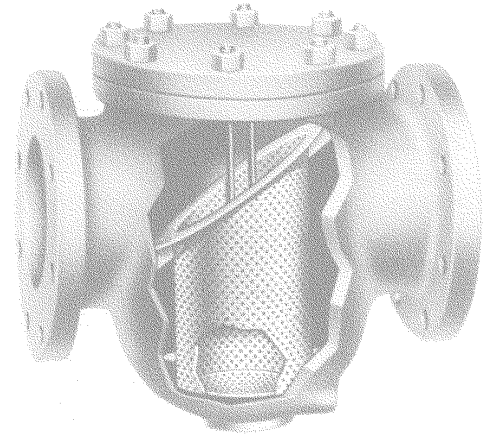

BOLT TOP

SIMPLEX STRAINER - For industrial use where temporary shutdown for cleaning is possible. Large basket capacity. The free straining area is at least 6 times the cross-sectional pipe area (even more in some sizes). No tools require to open cover. The quick opening, swinging yoke can be disassembled and the basket removed in seconds. This can be used as a backwash connection, if desired. Many styles available, including bolt top and clamp top



**ALL STRAINERS
AVAILABLE IN
STAINLESS STEEL, CAST
STEEL
OR PLASTIC!**



HAYWARD



BRASS FLARE FITTINGS

| SIZE | FIG. NO. | PRICE | SIZE | FIG. NO. | PRICE |
|------|----------|-------|------|----------|-------|
|------|----------|-------|------|----------|-------|

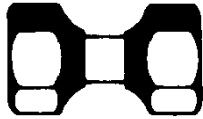

**No. 39
Swivel Nut**

O.D. TUBE

| | |
|------|-------|
| 3/16 | 37561 |
| 1/4 | 37580 |
| 5/16 | 37562 |

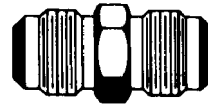

**No. 42
Full Flare Union**

O.D. TUBE

| | |
|----------|-------|
| 1/8 | 3807 |
| 3/16 | 4158 |
| 1/4 | 3814 |
| 5/16 | 3818 |
| 3/8 | 3821 |
| 1/2 | 17584 |
| 5/8 | 3832 |
| 3/4 | 3841 |
| 7/8 | 3845 |
| 5/16x1/4 | 4160 |
| 5/16x3/8 | 36093 |
| 3/8x1/4 | 3951 |

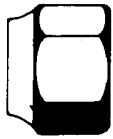

**No. 40
Forged Flare Nut**

O.D. TUBE

| | |
|------|------|
| 3/16 | 4153 |
| 1/4 | 3701 |
| 5/16 | 3706 |
| 3/8 | 4155 |
| 1/2 | 3722 |

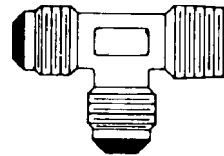

**No. 43
Flare X Male X Flare Tee**

O.D. TUBE X IPS

| | |
|----------|-------|
| 3/16x1/8 | 36094 |
| 1/4x1/8 | 4073 |
| 1/4x1/4 | 4077 |
| 5/16x1/8 | 36095 |
| 5/16x1/4 | 36096 |
| 3/8x1/4 | 4164 |
| 3/8x3/8 | 4084 |
| 1/2x3/8 | 4086 |
| 1/2x1/2 | 4098 |

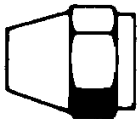

**No. 41
Flare Nut**

O.D. TUBE

| | |
|------|-------|
| 1/8 | 3745 |
| 3/16 | 3750 |
| 1/4 | 3755 |
| 5/16 | 3758 |
| 3/8 | 3759 |
| 7/16 | 36090 |
| 1/2 | 3762 |
| 5/8 | 3766 |

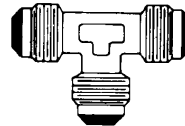

**No. 44
Full Flare Tee**

O.D. TUBE

| | |
|------|------|
| 1/8 | 4165 |
| 3/16 | 4166 |
| 1/4 | 4107 |
| 5/16 | 4108 |
| 3/8 | 4190 |
| 1/2 | 4191 |
| 5/8 | 4192 |

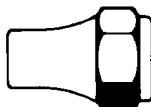

**No. 41-L
Long Flare Nut**

O.D. TUBE

| | |
|------|-------|
| 1/8 | 3778 |
| 3/16 | 3781 |
| 1/4 | 3783 |
| 5/16 | 17583 |
| 3/8 | 3790 |
| 1/2 | 3794 |

BRASS FLARE FITTINGS

| SIZE | FIG. NO. | PRICE | SIZE | FIG. NO. | PRICE |
|------|----------|-------|------|----------|-------|
|------|----------|-------|------|----------|-------|

No. 44
Full Flare Tee

O.D. TUBE

| | |
|-----------------|-------|
| 3/8 x 3/8 x 1/4 | 36101 |
| 3/8 x 3/8 x 1/2 | 36102 |
| 1/2 x 1/2 x 1/4 | 36107 |
| 1/2 x 1/2 x 3/8 | 36109 |
| 1/2 x 1/2 5/8 | 36108 |

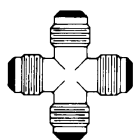

No. 44-A
Full Flare Cross

O.D. TUBE

| | |
|------|-------|
| 1/4 | 36120 |
| 5/16 | 36121 |
| 3/8 | 36122 |

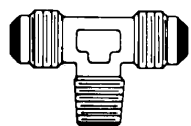

No. 45
Flare X Male IPT
on Branch Tee

O.D. TUBE X IPS

| | |
|------------|-------|
| 1/8 x 1/8 | 36125 |
| 3/16 x 1/8 | 36126 |
| 1/4 x 1/8 | 4201 |
| 1/4 x 1/4 | 4203 |
| 5/16 x 1/8 | 36127 |
| 5/16 x 1/4 | 36128 |
| 3/8 x 1/4 | 4207 |
| 3/8 x 3/8 | 4210 |
| 3/8 x 1/2 | 4213 |
| 1/2 x 3/8 | 4216 |



No. 37
Flare Cap

O.D. TUBE

| | |
|------|-------|
| 3/16 | 36087 |
| 1/4 | 3672 |
| 3/8 | 3680 |
| 1/2 | 3687 |

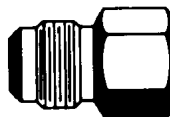

No. 46
Flare X Female IPT

O.D. TUBE X IPS

| | |
|------------|-------|
| 1/8 x 1/8 | 4235 |
| 3/16 x 1/8 | 36140 |
| 1/4 x 1/8 | 4236 |
| 1/4 x 1/4 | 4237 |
| 5/16 x 1/8 | 36143 |
| 5/16 x 1/4 | 36145 |
| 3/8 x 1/8 | 36146 |
| 3/8 x 1/4 | 4238 |
| 3/8 x 3/8 | 4239 |
| 3/8 x 1/2 | 4240 |
| 3/8 x 3/4 | 36147 |
| 1/2 x 1/4 | 4241 |
| 1/2 x 3/8 | 4242 |
| 1/2 x 1/2 | 4243 |
| 1/2 x 3/4 | 4244 |



No. 48
Flare X Male IPT Adapter

O.D. TUBE X IPS

| | |
|------------|-------|
| 1/8 x 1/8 | 4251 |
| 3/16 x 1/8 | 4252 |
| 1/4 x 1/8 | 4253 |
| 1/4 x 1/4 | 4254 |
| 1/4 x 3/8 | 4255 |
| 1/4 x 1/2 | 4256 |
| 5/16 x 1/8 | 36150 |
| 5/16 x 1/4 | 4257 |
| 5/16 x 3/8 | 4258 |
| 3/8 x 1/8 | 4259 |
| 3/8 x 1/4 | 4263 |
| 3/8 x 3/8 | 4266 |
| 3/8 x 1/2 | 4270 |
| 3/8 x 3/4 | 36152 |
| 1/2 x 1/4 | 4273 |
| 1/2 x 3/8 | 4276 |
| 1/2 x 1/2 | 4280 |

BRASS FLARE FITTINGS

| SIZE | FIG. NO. | PRICE | SIZE | FIG. NO. | PRICE |
|------|----------|-------|------|----------|-------|
|------|----------|-------|------|----------|-------|

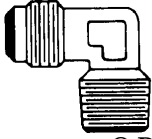

No. 49
Flare X Male

O.D. TUBE X IPS

| | |
|------------|-------|
| 1/8 x 1/8 | 4300 |
| 3/16 x 1/8 | 4301 |
| 3/16 x 1/4 | 36156 |
| 1/4 x 1/8 | 4305 |
| 1/4 x 1/4 | 4306 |
| 1/4 x 3/8 | 4307 |
| 1/4 x 1/2 | 4309 |
| 5/16 x 1/8 | 4311 |
| 5/16 x 1/4 | 4313 |
| 5/16 x 3/8 | 4332 |
| 3/8 x 1/8 | 4335 |
| 3/8 x 1/4 | 4338 |
| 3/8 x 3/8 | 4339 |
| 3/8 x 1/2 | 4341 |
| 3/8 x 3/4 | 4344 |
| 1/2 x 1/4 | 4345 |
| 1/2 x 3/8 | 4347 |
| 1/2 x 1/2 | 4349 |
| 1/2 x 3/4 | 4351 |
| 5/8 x 1/4 | 36157 |

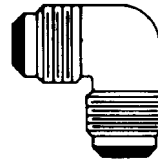

No. 55

O.D. TUBE

| | |
|------------|-------|
| 1/8 | 4380 |
| 3/16 | 4382 |
| 1/4 | 4383 |
| 5/16 | 4384 |
| 3/8 | 4386 |
| 1/2 | 4388 |
| 5/8 | 4389 |
| 3/4 | 4391 |
| 7/8 | 4393 |
| 3/8 X 1/4 | 4397 |
| 3/8 X 5/16 | 36169 |
| 1/2 X 3/8 | 4400 |

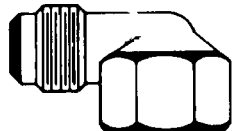

No. 50
Flare X Female

O.D. TUBE X IPS

| | |
|------------|-------|
| 3/16 X 1/8 | 4363 |
| 1/4 X 1/8 | 4364 |
| 1/4 X 1/4 | 4365 |
| 5/16 X 1/8 | 36163 |
| 5/16 X 1/4 | 4366 |
| 3/8 X 1/8 | 36164 |
| 1/8 X 1/4 | 4367 |
| 3/8 X 3/8 | 4368 |
| 3/8 X 1/2 | 4369 |
| 3/8 X 3/4 | 36165 |
| 1/2 X 1/4 | 4370 |
| 1/2 X 3/8 | 4371 |
| 1/2 X 1/2 | 4372 |
| 1/2 X 3/4 | 4373 |

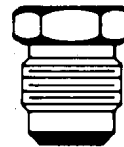

No. 57

O.D. TUBE

| | |
|------|-------|
| 3/16 | 36173 |
| 1/4 | 4404 |
| 5/16 | 36174 |
| 3/8 | 4406 |



DON'T FORGET TO
ORDER FLARE
NUTS FOR EVERY
FLARE FITTING



BRASS COMPRESSION FITTINGS

| SIZE | FIG. NO. | PRICE | SIZE | FIG. NO. | PRICE |
|------|----------|-------|------|----------|-------|
|------|----------|-------|------|----------|-------|



**No. 60
Compression Sleeve**

O.D. TUBE

| | |
|------|------|
| 1/8 | 4414 |
| 3/16 | 4416 |
| 1/4 | 4419 |
| 5/16 | 4421 |
| 3/8 | 4422 |
| 7/16 | 4425 |
| 1/2 | 4427 |



**No. 62
Full Compression Union**



O.D. TUBE

| | |
|------------|-------|
| 1/8 | 4476 |
| 3/16 | 4477 |
| 1/4 | 4481 |
| 5/16 | 4487 |
| 3/8 | 4489 |
| 5/8 | 4495 |
| 3/4 | 4496 |
| 7/8 | 4497 |
| 1/4 x 3/16 | 36177 |
| 3/8 x 1/4 | 4498 |
| 3/8 x 5/16 | 36178 |



**No. 60PT
Delrin Sleeve
For Plastic Tube**

O.D. TUBE

| | |
|------|------|
| 1/4 | 4440 |
| 5/16 | 4441 |
| 3/8 | 4443 |
| 1/2 | 4444 |



**No. 63PT
Brass Insert
For Plastic Tube**

O.D. TUBE

| | |
|------|------|
| 1/8 | 4519 |
| 3/16 | 4522 |
| 1/4 | 4523 |
| 5/16 | 4524 |
| 3/8 | 4525 |
| 1/2 | 4527 |
| 5/8 | 4528 |



**No. 61
Compression Nut**

O.D. TUBE

| | |
|------|------|
| 1/8 | 4457 |
| 3/16 | 4459 |
| 1/4 | 4462 |
| 5/16 | 4464 |
| 3/8 | 4465 |
| 7/16 | 4468 |
| 1/2 | 4470 |

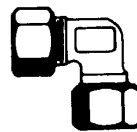

**No. 65
Full Compression Elbow**

O.D. TUBE

| | |
|------|-------|
| 1/8 | 4531 |
| 3/16 | 4532 |
| 1/4 | 4533 |
| 5/16 | 17586 |
| 3/8 | 4536 |
| 1/2 | 4537 |



**No. 62 CBH
Compression Bulkhead**

O.D. TUBE

| | |
|-----|------|
| 1/4 | 4508 |
| 3/8 | 4511 |

BRASS COMPRESSION FITTINGS

| SIZE | FIG. NO. | PRICE | SIZE | FIG. NO. | PRICE |
|------|----------|-------|------|----------|-------|
|------|----------|-------|------|----------|-------|

No. 66

Compression X Female Adapter
O.D. TUBE X IPS



| | |
|------------|-------|
| 1/8 x 1/8 | 4542 |
| 3/16 x 1/8 | 36180 |
| 3/16 x 1/4 | 4543 |
| 1/4 x 1/8 | 4550 |
| 1/4 x 1/2 | 4558 |
| 5/16 x 1/8 | 20851 |
| 5/16 x 1/4 | 4561 |
| 3/8 x 1/8 | 4563 |
| 3/8 x 1/4 | 4567 |
| 3/8 x 3/8 | 4569 |
| 3/8 x 1/2 | 4571 |
| 1/2 x 1/4 | 4573 |
| 1/2 x 3/8 | 4576 |
| 1/2 x 1/2 | 4578 |
| 5/8 x 3/8 | 4581 |
| 5/8 x 1/2 | 4583 |

No.68TF

Compression X Male IPT Adapter Tank Fitting (Tapped Straight Through)



O.D. TUBE X IPS

| | |
|-----------|------|
| 3/8 x 3/8 | 4705 |
| 3/8 x 1/2 | 4706 |
| 1/2 x 3/8 | 4708 |

No. 68

Compression X Male IPT Adapter



O.D. TUBE

| | |
|------------|------|
| 1/8 x 1/8 | 4615 |
| 3/16 x 1/8 | 4619 |
| 3/16 x 1/4 | 4620 |
| 1/4 x 1/8 | 4623 |
| 1/4 x 1/4 | 4625 |
| 1/4 x 3/8 | 4626 |
| 1/4 x 1/2 | 4628 |
| 5/16 x 1/8 | 4631 |
| 5/16 x 1/4 | 4633 |
| 5/16 x 3/8 | 4634 |
| 3/8 x 1/8 | 4635 |
| 3/8 x 1/4 | 4638 |
| 3/8 x 3/8 | 4639 |
| 3/8 x 1/2 | 4641 |
| 3/8 x 3/4 | 4642 |
| 7/16 x 1/4 | 4644 |
| 1/2 x 1/4 | 4647 |
| 1/2 x 3/8 | 4648 |
| 1/2 x 1/2 | 4650 |
| 1/2 x 3/4 | 4651 |

No. 69

Compression X Male IPT Elbow

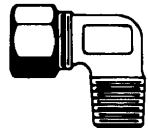

O.D. TUBE

| | |
|------------|-------|
| 1/8 x 1/8 | 4741 |
| 3/16 x 1/8 | 22582 |
| 3/16 x 1/4 | 23681 |
| 1/4 x 1/8 | 4743 |
| 1/4 x 1/4 | 4745 |
| 1/4 x 3/8 | 4746 |
| 5/16 x 1/8 | 20261 |
| 5/16 x 1/4 | 4748 |
| 5/16 x 3/8 | 23682 |
| 3/8 x 1/8 | 4750 |
| 3/8 x 1/4 | 4751 |
| 3/8 x 3/8 | 4752 |
| 3/8 x 1/2 | 4754 |
| 3/8 x 3/4 | 36184 |
| 7/16 x 1/4 | 36185 |
| 7/16 x 3/8 | 36186 |
| 1/2 x 1/4 | 4755 |
| 1/2 x 3/8 | 4757 |
| 1/2 x 1/2 | 4759 |
| 5/8 x 3/8 | 4761 |



BRASS COMPRESSION FITTINGS

| SIZE | FIG. NO. | PRICE | SIZE | FIG. NO. | PRICE |
|------|----------|-------|------|----------|-------|
|------|----------|-------|------|----------|-------|

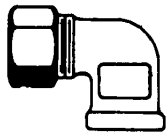

No. 70
Compression X Female

O.D. TUBE X IPS

| | |
|------------|-------|
| 1/8 X 1/8 | 4787 |
| 3/16 X 1/8 | 36187 |
| 1/4 X 1/8 | 4789 |
| 1/4 X 1/4 | 4791 |
| 5/16 X 1/8 | 36188 |
| 5/16 X 1/4 | 36189 |
| 3/8 X 1/8 | 36190 |
| 3/8 X 1/4 | 4794 |
| 3/8 X 3/8 | 4797 |
| 3/8 X 1/2 | 4801 |
| 1/2 X 3/8 | 4803 |
| 1/2 X 1/2 | 4806 |

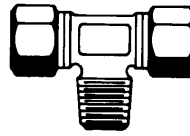

No. 72
Compression X Male Tee

O.D. TUBE

| | |
|------------|-------|
| 1/8 X 1/8 | 4850 |
| 3/16 X 1/8 | 36200 |
| 1/4 X 1/8 | 4853 |
| 1/4 X 1/4 | 4854 |
| 5/16 X 1/8 | 36201 |
| 5/16 X 1/4 | 36202 |
| 3/8 X 1/8 | 4856 |
| 3/8 X 1/4 | 4857 |
| 3/8 X 3/8 | 4862 |
| 1/2 X 3/8 | 4863 |
| 1/2 X 1/2 | 4866 |

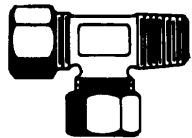

No. 71
Compression X Male X
Compression Tee

O.D. TUBE

| | |
|------------|-------|
| 1/8 x 1/8 | 4815 |
| 3/16 x 1/8 | 36193 |
| 1/4 x 1/8 | 4825 |
| 1/4 x 1/4 | 4827 |
| 5/16 x 1/8 | 36194 |
| 5/16 x 1/4 | 36195 |
| 3/8 x 1/4 | 4833 |
| 3/8 x 3/8 | 4838 |
| 1/2 x 3/8 | 4841 |
| 1/2 x 1/2 | 4844 |
| 5/8 x 1/2 | 4848 |

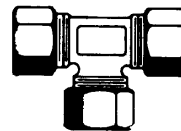

No. 74
Full Compression Tee

O.D. TUBE

| | |
|------|------|
| 1/8 | 4871 |
| 3/16 | 4872 |
| 1/4 | 4873 |
| 5/16 | 4875 |
| 3/8 | 4877 |
| 1/2 | 4878 |



Compression by Sweat
(DELTA Fitting)

O.D. TUBE

| | |
|-------------|-------|
| 3/8"ODX1/2" | 11022 |
| NOM COPPER | |

ALUMINUM TUBING

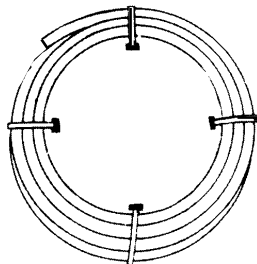

50' COIL

| SIZE | FIG. NO. | PRICE |
|------|----------|-------|
| 1/8 | 16303 | |
| 3/16 | 16306 | |
| 1/4 | 16313 | |
| 5/16 | 16315 | |
| 3/8 | 16317 | |
| 7/16 | 16325 | |
| 1/2 | 16329 | |
| 5/8 | 16332 | |
| 3/4 | 16335 | |



FLEXIBLE CONNECTORS
SWEAT

THREADED

Stainless Steel Hose and Braid

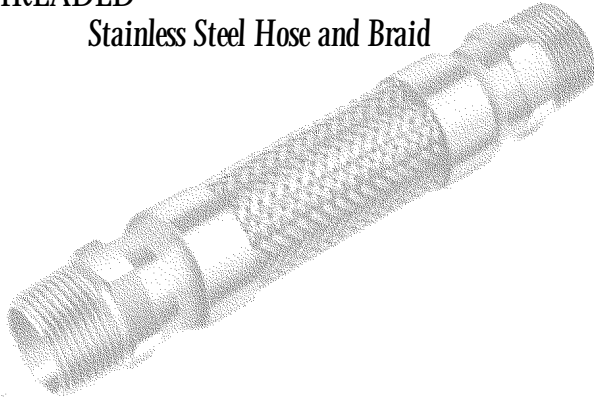

Brass Hose and Braid

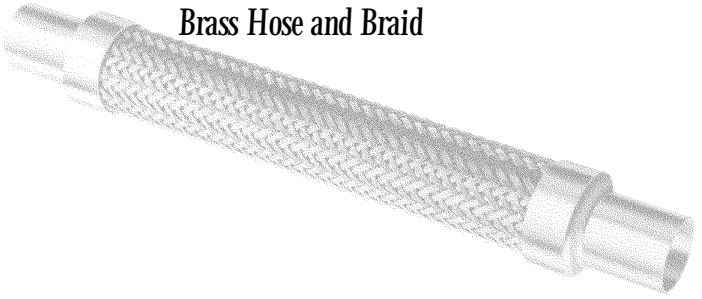

Duff pump connectors are a perfect match of hose type, wall thickness and braid design to minimize forces and stress within piping systems. These connectors are factory engineered, manufactured and tested to effectively minimize the stress of pump and compression housings, and to isolate vibrations transmitted by mechanical equipment. And today, Duff can help you comply with noise level requirements by reducing pipe vibration throughout a structure. Duff protection means longer service life, lower overall operating costs and years of trouble-free service.

Minimize compressor vibration right at the source with Duff's flex connectors - the standard of the industry. Sweat end flex connectors are made in tube sizes 1/4" to 61/18". UL recognized in sizes to 4". Flexible corrugated tube of special grade phosphorous bronze for high strength and stability under continuous flexing and vibration, and for resistance to the corrosive action of freon and methyl chloride. The flexible tube is covered with a balanced bronze braid, engineered for a combination of strength and flexibility. Female solder end fittings and braid sleeves are skillfully attached.

| Size | Fig No | Price |
|------------|--------|-------|
| 1/2 x 10 | 15292 | |
| 3/4 x 10 | 15293 | |
| 1 x 10 | 15294 | |
| 1 1/4 x 10 | 15295 | |
| 1 1/2 x 12 | 15296 | |
| 2 x 14 | 15297 | |
| 2 1/2 x 16 | 17671 | |
| 3 x 16 | 17670 | |

| Size | Fig No | Price |
|----------------|--------|-------|
| 1/8 x 7 1/2 | 49307 | |
| 1/4 x 1 1/4 | 15243 | |
| 3/8 x 9 | 15250 | |
| 1/2 x 9 3/4 | 15262 | |
| 5/8 x 11 1/4 | 17553 | |
| 3/4 x 11 1/2 | 15279 | |
| 1 x 13 | 17554 | |
| 1 1/4 x 14 3/4 | 15285 | |
| 1 1/2 x 17 | 15287 | |
| 2 x 20 | 15289 | |
| 2 1/2 x 24 | 15290 | |
| 3 x 27 | 15291 | |

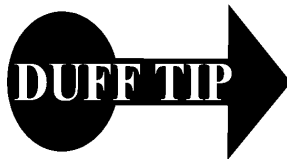

Flexible connectors can be made in any length and any end configuration. For example, we can make a 2 x 23" with a carbon steel male on one end and a Stainless Steel flange on the other!



Duff flanged flex connectors are a perfect match of hose type, wall thickness and braid design to minimize the forces and stress within piping systems. These connectors are factory engineered, manufactured and tested to effectively minimize the stress of pump and compression housings, and to isolate vibrations transmitted by mechanical equipment. And today, Duff can help you comply with noise level requirements by reducing pipe vibration through a structure. Duff protection means longer service life, lower overall operating costs and years of trouble-free service.

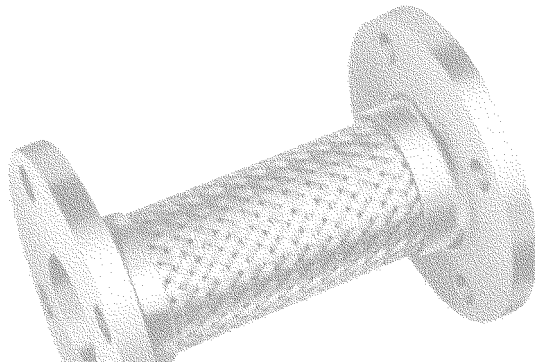

| Size | Fig No | Price |
|-------|--------|-------|
| 3 x 9 | 17672 | |
| 4 x 9 | 17673 | |

MANY OTHER SIZES AND LENGTHS ARE AVAILABLE FROM STOCK OR CAN BE CUSTOM FABRICATED!

EXPANSION COMPENSATORS

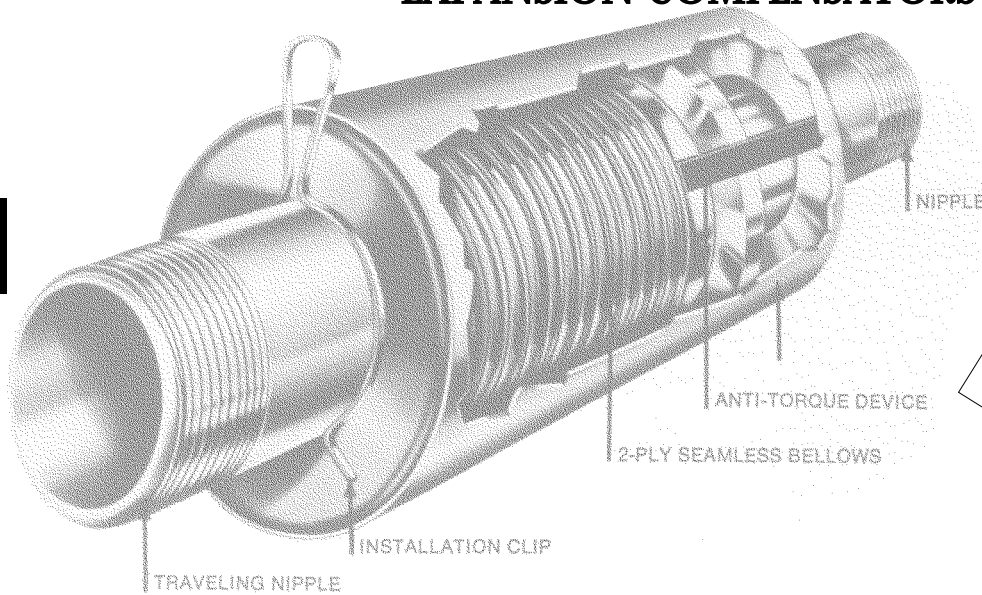

EXPANSION COMPENSATORS - the perfect way to absorb pipe motion in small diameter systems. High pressure types permit 2" pipe motion - 1 3/4" compression and 1/4" in extension. Duff's expansion compensators provide the lowest cost method to take up thermal growth.

AVAILABLE FOR QUICK DELIVERY!

HIGH AND LOW PRESSURE EXPANSION JOINTS



| Available for Immediate Delivery | LOW PRESSURE | | HIGH PRESSURE | |
|---|--|---|--|---|
| | SINGLE | DUAL | SINGLE | DUAL |
| SIZE RANGE | 3" TO 4" NPS | 3" TO 48" NPS | 3" TO 24" NPS | 3" TO 24" NPS |
| ALLOWABLE PRESSURE (Stainless Steel Pressure Carrier) | Vacuum to 50 PSI | Vacuum to 50 PSI | Vacuum To 300 PSI | Vacuum to 300 PSI |
| TEMPERATURE LIMITS (Stainless Steel Pressure Carrier) | -20 to 850 Deg F | -20 to 850 Deg F | Flanges- -20 F to 800 Deg F Welding Ends- -20 F to 85 Deg F | -20 F to 800 Deg F -20 Deg F to 850 Deg F |
| AXIAL TRAVERSE | To 6 1/4" (depending on size) | To 12 1/2" | To 7 1/2" (Depending on size) | To 15" (Depending on size) |
| LATERAL MOTION | Variable amount depending of size and certain conditions | Virtually unlimited, depending on length of intermediate nipple | Limited amount under certain conditions | Virtually unlimited, depending on length of intermediate nipple |



RUBBER EXPANSION JOINTS

APPLICATIONS

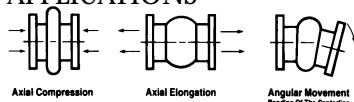

TYPES

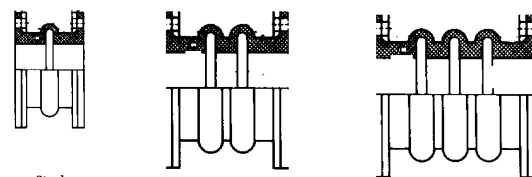

Designed for tough demanding industrial applications, as found in: Air-conditioning-heating and ventilating systems, chemical petrochemical and industrial process piping systems, power generating plants, steel mills, marines services. Pulp/paper systems, water-wastewater-sewage and pollution control systems. Installed net to mechanical equipment or between the anchor points of a piping system. Absorb pipe movement/stress; reduce system noise; isolate mechanical vibration; compensate alignment/offset; eliminate electrolysis; protect against start-up forces.



BASE SLIDE EXPANSION COUPLERS Triples the expansion movement of most bellow-type joints in baseboard radiation and supply piping and main. Trouble-free, piston-slide design provides smooth operation and elimination of expansion and pipe traveling noises. Copper piston tube. Simplified installation. No maintenance when properly installed. Available in 3 sizes to fit any diameter pipe or tube from 3/4" to 1 1/4"

| Size | SWEAT | IPS |
|-------|--------|-------|
| | Fig No | Price |
| 3/4 | 8480 | 8495 |
| 1 | 8487 | 8499 |
| 1 1/4 | 8490 | 8504 |

HANGERS AND FASTENERS

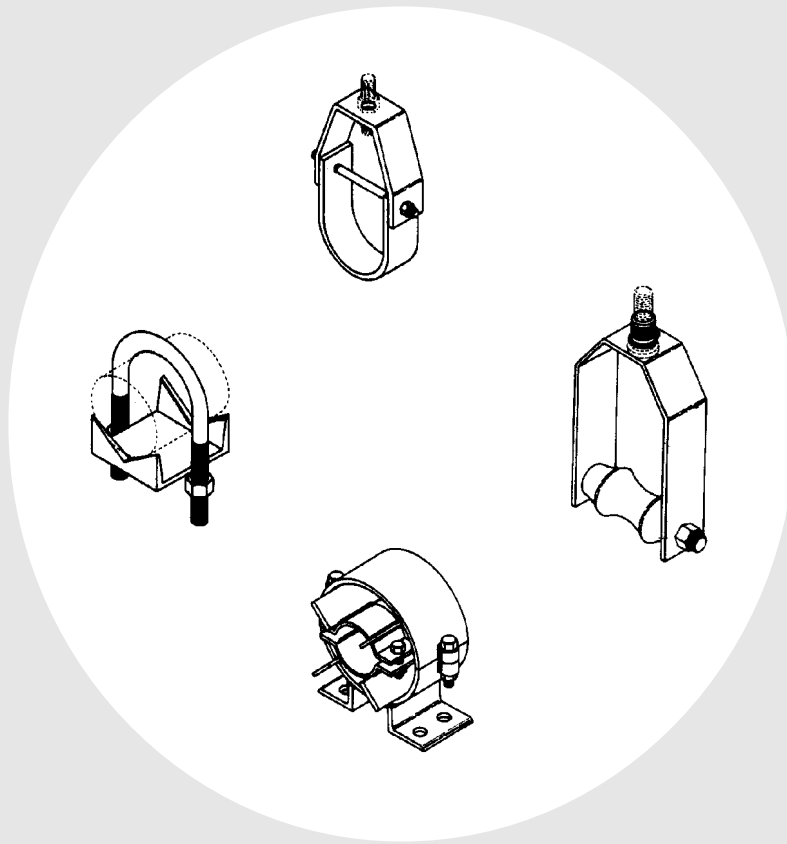

HANGERS AND FASTENERS

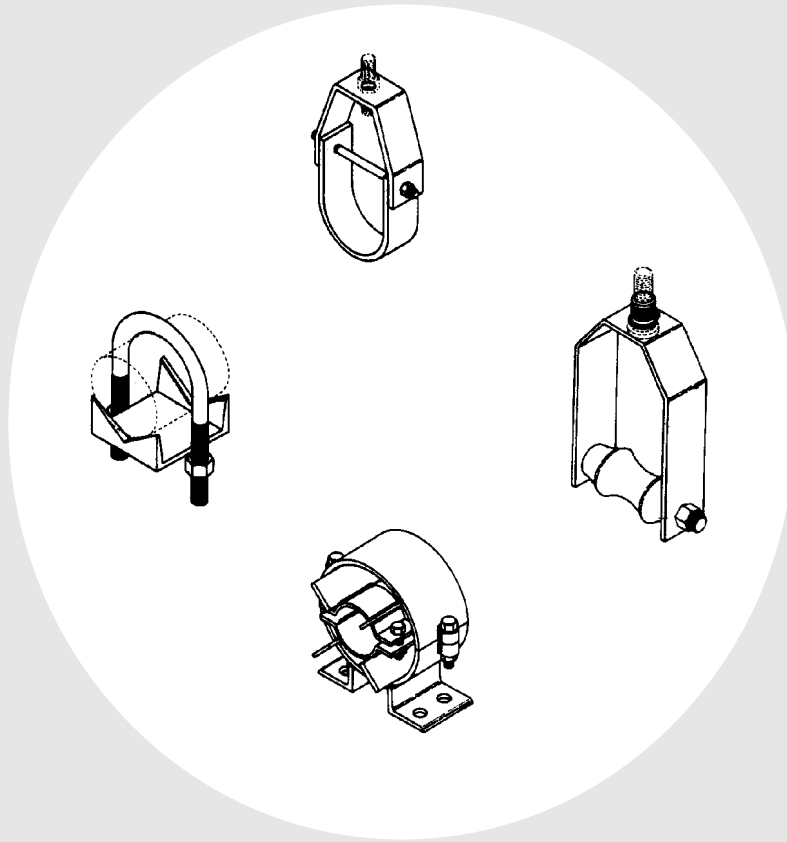

Whether it is:

Hung

Sprung

Clamped

Supported

Guided

Rolled

Bolted

**or
Hooked**

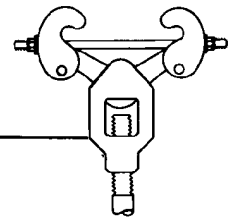
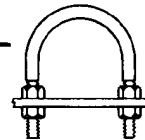
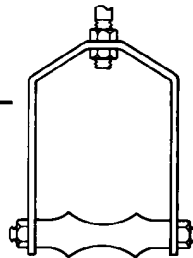
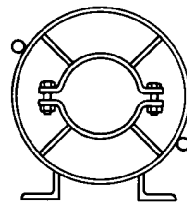
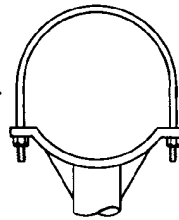
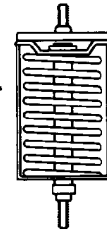
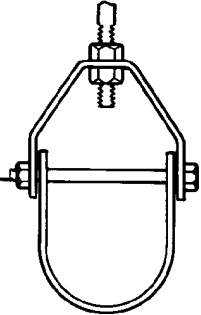

We've got the material in stock and we can get it out to you TODAY!

DUFF CO.

HANGERS AND FASTENERS

REZNROR HOOKS

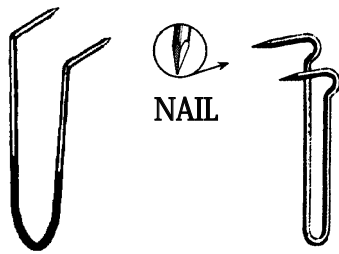

OTHER SIZES AVAILABLE!

| SIZE | PIPE SIZE | | TUBING SIZE | | | |
|-----------|-----------|-------|-------------|-------|----------------|-------|
| | STEEL | | COPPER CLAD | | PLASTIC COATED | |
| | FIG. NO. | PRICE | FIG. NO. | PRICE | FIG. NO. | PRICE |
| 1/2 x 8 | 7139 | | 25136 | | 7145 | |
| 3/4 x 8 | 40637 | | 25137 | | 7146 | |
| 1 x 8 | 23015 | | 14399 | | | |
| 1 1/4 x 8 | 7142 | | 14402 | | | |
| 1 1/2 x 8 | 7143 | | 14405 | | | |
| 2 x 8 | 7144 | | 14407 | | | |

*Eliminates Electrolysis
*Reduces "Shimmy"

HANGER STRAPPING

*STEEL *COPPER

*PLASTIC

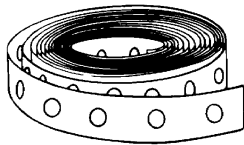

| SIZE | MATERIAL | FIG. NO. | PRICE |
|------------|-------------------|----------|-------|
| 3/4 X 10' | Cold Rolled Steel | 14201 | |
| 3/4 X 100' | Cold Rolled Steel | 14202 | |
| 3/4 X 100' | Galvanized | 43185 | |
| 3/4 X 10' | Copper Clad | 14410 | |
| 3/4 X 100' | Copper Clad | 14414 | |
| 3/4 X 100' | Plastic | 15991 | |
| 3/4 X 25' | Solid Copper | 14419 | |

ALSO AVAILABLE IN PURE COPPER,
ALUMINUM & STAINLESS STEEL

PIPE AND TUBING STRAPS



| SIZE | TWO EAR STRAP | | ONE EAR STRAP | |
|-------|----------------------|-------|-------------------------|-------|
| | PIPE SIZE GALVANIZED | | TUBING SIZE COPPER CLAD | |
| | FIG. NO. | PRICE | FIG. NO. | PRICE |
| 1/8 | - | | 36554 | - |
| 1/4 | 17607 | | 14420 | 14186 |
| 3/8 | 14168 | | 14422 | 14191 |
| 1/2 | 14170 | | 14423 | 14192 |
| 3/4 | 14171 | | 14425 | 14194 |
| 1 | 14173 | | 14426 | 14196 |
| 1 1/4 | 14174 | | 14428 | 14197 |
| 1 1/2 | 14176 | | 14429 | 14198 |
| 2 | 14178 | | 14430 | 14200 |
| 2 1/2 | 14179 | | | |
| 3 | 14181 | | | |
| 4 | 14183 | | | |

ALL SIZES AVAILABLE IN PURE COPPER

ALL HANGERS AND FASTENERS
AVAILABLE IN STAINLESS STEEL

INSULATION SHIELDS

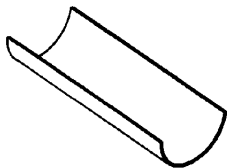

18 GAUGE X 12.

Used when the clevis hanger is used on the outside of insulation. Prevent crushing of insulation or breaking the vapor barrier by the hanger or support. Various thicknesses available, please call for dimensional data and current pricing!
STANDARD

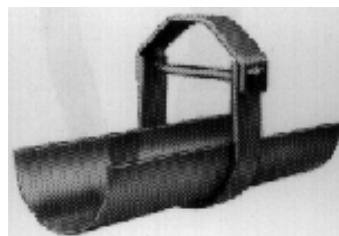

ALSO AVAILABLE IN COPPER CLAD!

| Fig. No. | Size (inches) | Clevis Hanger Size | Approx Wt per 100 | Price |
|----------|---------------|--------------------|-------------------|-------|
| 64543 | 2.375 | 2 | 65 | |
| 64544 | 2.875 | 2 1/2 | 77 | |
| 64545 | 3.500 | 3 | 94 | |
| 64546 | 4.000 | 3 1/2 | 107 | |
| 64547 | 4.500 | 4 | 121 | |
| 64548 | 5.625 | 5 | 158 | |
| 64549 | 6.625 | 6 | 179 | |
| 64550 | 7.625 | 7 | 202 | |
| 64551 | 8.625 | 8 | 228 | |
| 64553 | 10.750 | 10 | 284 | |



Choose by size of hanger you are using, NOT by the size of pipe!!

RISER CLAMPS

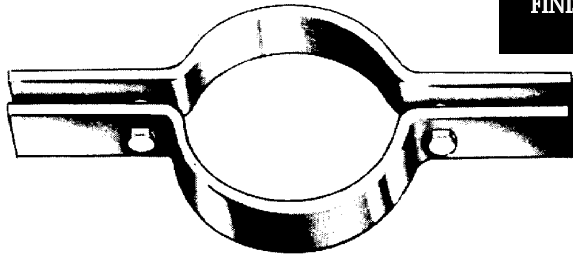

**MOST
HANGERS AVAILABLE IN
GALVANIZED
FINISH OR STAINLESS
STEEL**

| SIZE | PIPE SIZE | | TUBING SIZE | |
|-------|-----------|-------|-------------|-------|
| | BLACK | | COPPER CLAD | |
| | FIG. NO. | PRICE | FIG. NO. | PRICE |
| 1/2 | 14230 | | 14479 | |
| 3/4 | 14232 | | 14480 | |
| 1 | 14234 | | 14481 | |
| 1 1/4 | 14236 | | 14482 | |
| 1 1/2 | 14238 | | 14483 | |
| 2 | 14240 | | 14484 | |
| 2 1/2 | 14242 | | 14485 | |
| 3 | 14243 | | 14487 | |
| 3 1/2 | 14245 | | 14488 | |
| 4 | 14247 | | 14489 | |
| 5 | 14248 | | 14490 | |
| 6 | 14250 | | 14491 | |
| 8 | 14252 | | - | |
| 10 | 14253 | | - | |

SERVICE: FOR SUPPORT AND STEADYING OF ST PIPE RISERS - EITHER INSULATED OR BARE, CAST IRON PIPE OR CONDUIT.

CLEVIS HANGERS

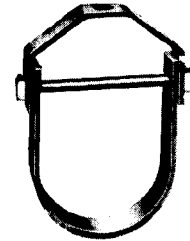

| SIZE | PIPE SIZE | | TUBING SIZE | |
|-------|-----------|-------|-------------|-------|
| | BLACK | | COPPER CLAD | |
| | FIG. NO. | PRICE | FIG. NO. | PRICE |
| 1/2 | 14204 | | 14434 | |
| 3/4 | 14205 | | 14435 | |
| 1 | 14206 | | 14436 | |
| 1 1/4 | 14208 | | 14437 | |
| 1 1/2 | 14210 | | 14438 | |
| 2 | 14211 | | 14439 | |
| 2 1/2 | 14213 | | 14440 | |
| 3 | 14215 | | 14442 | |
| 3 1/2 | 14216 | | 14444 | |
| 4 | 14219 | | 14472 | |
| 5 | 14220 | | 14474 | |
| 6 | 14223 | | 14478 | |
| 8 | 14225 | | - | |
| 10 | 14227 | | - | |
| 12 | 47162 | | - | |

SERVICE: RECOMMENDED FOR THE SUSPENSION OF NON-INSULATED, STATIONARY PIPE LINES.

SPLIT RING HANGERS

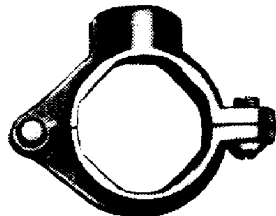

| SIZE | PIPE SIZE | | | | TUBING SIZE | |
|-------|-----------|-------|------------|-------|-------------|-------|
| | STEEL | | GALVANIZED | | COPPER CLAD | |
| | FIG. NO. | PRICE | FIG. NO. | PRICE | FIG. NO. | PRICE |
| 3/8 | 39288 | | 24573 | | | |
| 1/2 | 39289 | | 14256 | | 14504 | |
| 3/4 | 39290 | | 14258 | | 14505 | |
| 1 | 39291 | | 14260 | | 14506 | |
| 1 1/4 | 39292 | | 14262 | | 14507 | |
| 1 1/2 | 39293 | | 14263 | | 14508 | |
| 2 | 39294 | | 14265 | | 14509 | |
| 2 1/2 | 44485 | | 14268 | | 22004 | |
| 3 | 44486 | | 14270 | | 19987 | |
| 4 | 44487 | | 14272 | | 25698 | |

DUFF CO.

C-CLAMP

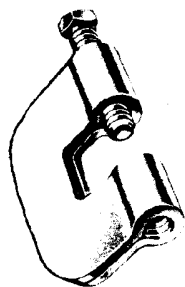

| SIZE | BLACK | | GALVANIZED | | MALLEABLE IRON | |
|------|----------|-------|------------|-------|----------------|-------|
| | FIG. NO. | PRICE | FIG. NO. | PRICE | FIG. NO. | PRICE |
| 3/8 | 14297 | | 53608 | | 14304 | |
| 1/2 | 14299 | | | | 14306 | |
| 5/8 | 14300 | | | | | |
| 3/4 | 14302 | | | | | |

HANGERS AND FASTENERS

JUNIOR BEAM CLAMP

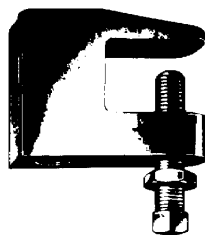

| SIZE | FIG NO | PRICE |
|------|--------|-------|
| 3/8 | 14307 | |
| 1/2 | 14309 | |

GALVANIZED

| SIZE | FIG NO | PRICE |
|------|--------|-------|
| 3/8 | 49126 | |
| 1/2 | 56919 | |

SERVICE: Recommended for use under roof installations with bar joist type construction, or for attachment to the top or bottom flange of structural shapes where the vertical hanger rod is required to be offset from the edge of the flange and where the thickness of joist or flange does not exceed 3/4 inch.

U-BOLT

Furnished with hex nuts

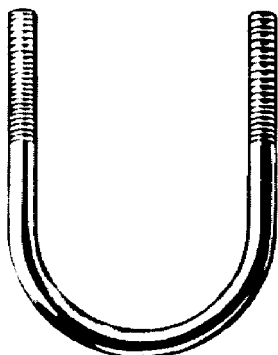

| PIPE SIZE | FIG NO | PRICE |
|-----------|--------|-------|
| 1/2 | 14340 | |
| 3/4 | 14342 | |
| 1 | 14344 | |
| 1 1/4 | 14346 | |
| 1 1/2 | 14347 | |
| 2 | 14348 | |
| 2 1/2 | 14350 | |
| 3 | 14351 | |
| 3 1/2 | 14353 | |
| 4 | 14355 | |
| 5 | 14356 | |
| 6 | 14358 | |





U-BOLTS PROVIDED IN LIGHT WEIGHT PATTERN THROUGH 4 INCH, AND STANDARD PATTERN 5 INCHES AND ABOVE, UNLESS OTHERWISE SPECIFIED.

ADJUSTABLE SWIVEL RING

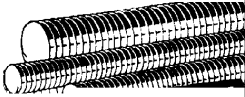
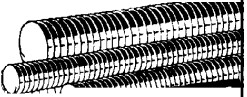

| SIZE | PIPE SIZE | | COPPER TUBING SIZE | |
|-------|-----------|-------|--------------------|-------|
| | FIG. NO. | PRICE | FIG. NO. | PRICE |
| 1/2 | 14274 | | 14492 | |
| 3/4 | 14277 | | 14493 | |
| 1 | 14278 | | 14494 | |
| 1 1/4 | 14281 | | 14495 | |
| 1 1/2 | 14282 | | 14496 | |
| 2 | 14284 | | 14497 | |
| 2 1/2 | 14286 | | 14498 | |
| 3 | 14288 | | 14499 | |
| 4 | 14289 | | 14501 | |

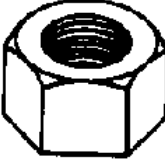
SERVICE: RECOMMENDED FOR SUSPENSION OF NON-INSULATED, STATIONARY PIPE LINE.

| <u>ALL THREAD ROD</u> SIX FEET LONG | | | <u>GALVANIZED</u> <u>ALL THREAD ROD</u> SIX FEET LONG | | | <u>ROD COUPLING</u> | | <u>NUTS</u> | | <u>WASHERS</u> | |
|---|--------|-------|---|-------|--------|--|--------|---|--------|---|--|
|  | | |  | | |  | |  | |  | |
| SIZE | FIG NO | PRICE | FIG NO | PRICE | FIG NO | PRICE | FIG NO | PRICE | FIG NO | PRICE | |
| 1/4 | 14510 | | 49180 | | 14319 | | 14374 | | 50643 | | |
| 5/16 | 14511 | | - | | 14321 | | 14379 | | 50641 | | |
| 3/8 | 14512 | | 48889 | | 14323 | | 50595 | | 50642 | | |
| 1/2 | 14513 | | 50539 | | 14325 | | 14542 | | 50640 | | |
| 5/8 | 14515 | | 50647 | | 14326 | | 14546 | | 55291 | | |
| 3/4 | 14517 | | - | | 14328 | | 14547 | | 55486 | | |
| 7/8 | 14518 | | - | | 14331 | | 14549 | | 14370 | | |
| 1 | 14521 | | - | | 14333 | | 44350 | | 14372 | | |
| 3/8X1/4 | - | | - | | 14336 | | - | | - | | |
| 1/2X3/8 | - | | - | | 14338 | | - | | - | | |



STEEL ANGLE BEAM BRACKET

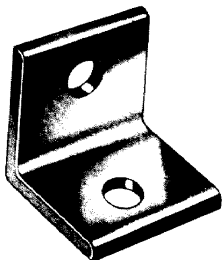

| SIZE | FIG NO | PRICE |
|------|--------|-------|
| 3/8 | 14312 | |
| 1/2 | 14314 | |

LAG SCREW



| SIZE | FIG NO | PRICE |
|-------------|--------|-------|
| 3/8 X 3 1/2 | 14315 | |
| 1/2 X 3 1/2 | 14317 | |

PLEASE GIVE FIGURE NUMBERS WHEN ORDERING



HANGER PLATE

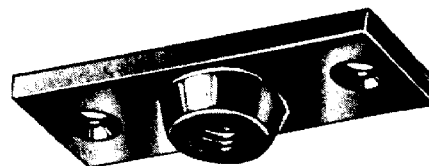

| SIZE | BLACK | | GALVANIZED | | COPPER | |
|------|----------|-------|------------|-------|----------|-------|
| | FIG. NO. | PRICE | FIG. NO. | PRICE | FIG. NO. | PRICE |
| 3/8 | 14431 | | 40114 | | 14433 | |
| 1/2 | 14432 | | 40115 | | 14434 | |

STRUT AND CHANNEL

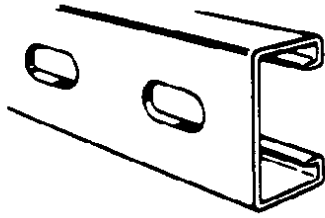

1 5/8 X 10 FOOT CHANNEL WITH ELONGATED HOLES

*Channel provided in green finish unless otherwise specified - available in plain or galvanized finish, in different sizes with different hole configurations.

| FIG NO | PRICE |
|--------|-------|
| 38558 | |

STRUT CLAMPS

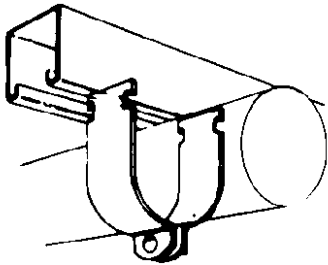

| SIZE | STEEL PIPE | | TUBING SIZE | |
|------|------------|-------|-------------|-------|
| | FIG. NO. | PRICE | FIG. NO. | PRICE |
| 1/2 | 41122 | | 41131 | |
| 3/4 | 41123 | | 41132 | |
| 1 | 41124 | | 41133 | |
| 1 | 41125 | | 41134 | |
| 1/4 | 41126 | | 41135 | |
| 1 | 41127 | | 41136 | |
| 1/2 | 41128 | | - | |
| 2 | 41129 | | 44860 | |
| 2 | 41130 | | - | |



X-RAY EQUIPMENT SUPPORT



MERCURY VAPOR LIGHT SUPPORT



GARMENT RACK

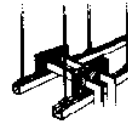

MAPLE BUS BAR SUPPORT

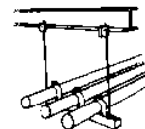

CONDUIT ON TRAPEZE

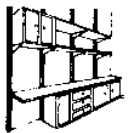

WALL MOUNTED SHELVING

**DUFF POWER STRUT LINE
HAS MORE THAN 8,000 QUALITY PRODUCTS**

The Power strut metal framing system can be regarded as a basic building material. Our metal framing system is an erector set concept, using channel and fittings to solve many applications. You can conceal metal framing in the basic structure of a building or run it along the surface of walls, ceilings and floors. An endless array of fittings provide freedom to work at virtually any angle along any surface to shape a support system that fits your exact needs. For further information, please call Duff at 610-275-4453, or fax us at 610-279-6299.

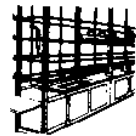

LABORATORY FRAMING



FLUORESCENT SUPPORT



EQUIPMENT RAILINGS, RACKS



GENERAL STORAGE RACKS



POWER TOOL SUPPORT

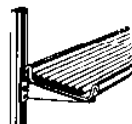

CABLE TRAY S SUPPORTS



RAILINGS, RACKS, AND MEZZANINE



EXHIBITION OR DISPLAY STANDS



REEL RACKS

PLASTIC "J-HOOKS"

Heavy duty construction for hanging tubing or pipe

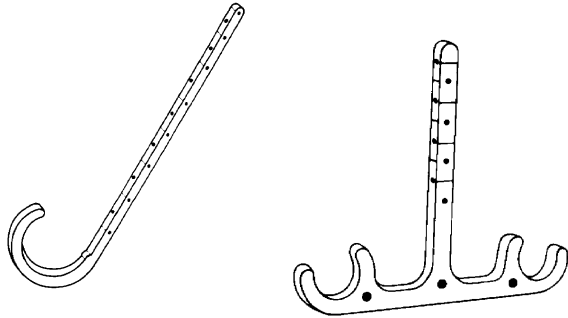

| SIZE | SINGLE | | DOUBLE | |
|---------|----------|-------|----------|-------|
| | FIG. NO. | PRICE | FIG. NO. | PRICE |
| 1/2 | 15974 | | 15986 | |
| 1/2X3/4 | - | | 15988 | |
| 3/4 | 15976 | | 15989 | |
| 1 | 15977 | | - | |
| 1 1/4 | 15978 | | - | |
| 2 | 15981 | | - | |
| 3 | 15983 | | - | |
| 4 | 15985 | | - | |

PLASTIC COATED HANGER

Ideal for plastic pipe

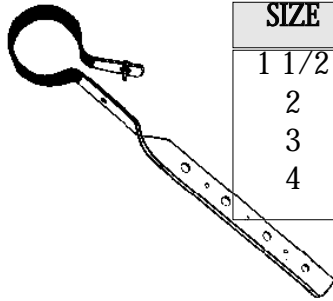

| SIZE | FIG NO | PRICE |
|-------|--------|-------|
| 1 1/2 | 36454 | |
| 2 | 36455 | |
| 3 | 36456 | |
| 4 | 36457 | |

VAN HANGERS



| SIZE | FIG NO | PRICE |
|------|--------|-------|
| 1/2 | 14532 | |
| 3/4 | 14533 | |
| 1 | 14534 | |

AMERICAN TUBE HANGER

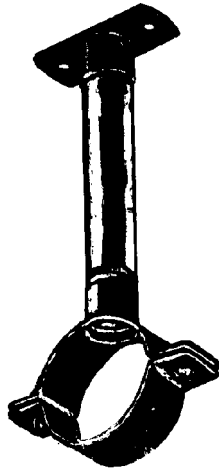

| SIZE | FIG NO | PRICE |
|-------|--------|-------|
| 1/2 | 14522 | |
| 3/4 | 14524 | |
| 1 | 14527 | |
| 1 1/4 | 14528 | |
| 1 1/2 | 14530 | |
| 2 | 14531 | |



Whenever ordering any type of hanger, always remember to order insulation shields!

INDUSTRIAL ANCHORS SOLD ONLY IN BOX QUANTITIES

ROD HANGER WEDGE ANCHOR



| SIZE | DRILL DIA | NO PER BOX | FIG NO | PRICE |
|------|-----------|------------|--------|-------|
| 3/8 | 1/2 | 25 | 44351 | |
| 1/2 | 5/8 | 25 | 44352 | |
| 5/8 | 7/8 | 10 | 44353 | |

Rawl

**IN STOCK AND
READY TO
SHIP!**

DOUBLE EXPANSION SHIELD



HEAVY DUTY BOLT ANCHOR

| SIZE | NO. PER BOX | FIG. NO. | PRICE |
|------|-------------|----------|-------|
| 1/4 | 50 | 27842 | |
| 5/16 | 50 | 27843 | |
| 3/8 | 50 | 27844 | |
| 1/2 | 25 | 27845 | |
| 5/8 | 25 | 27846 | |
| 3/4 | 10 | 27847 | |

A NON-CAULKING BOLT ANCHOR WHICH IS EASY TO INSTALL. TIGHTENING THE BOLT SETS THE ANCHOR. FOR USE IN CONCRETE, BRICK OR STONE WITH A MACHINE SCREW OR BOLT.

LOCK/BOLT ROD HANGER

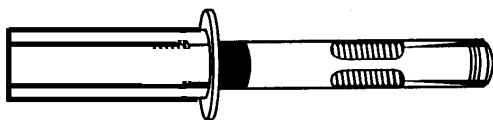

| FIG. NO. | SIZE | DRILL DIA. | MIN. DEPTH | BOX QTY | PRICE |
|----------|--------|------------|------------|---------|-------|
| 62694 | 3/8"X1 | 3/8" | 1 5/8" | 50 | |
| 63847 | 7/8" | 1/2" | 2 1/4" | 25 | |

STEEL DROP-IN (Internal Plug)



USE IN: Concrete, stone

USE WITH: Machine screw, bolt, or threaded rod

SIZE RANGE: 1/4" through 3/4"

| FIG. NO. | SIZE | DRILL DIA. | MIN. DEPTH | THREAD DEPTH | BOX QTY | PRICE |
|----------|------|------------|------------|--------------|---------|-------|
| 50508 | 3/8" | 1/2" | 1 7/8" | 5/8" | 50 | |
| 50509 | 1/2" | 5/8" | 2 3/8" | 13/16" | 50 | |

SETTING TOOLS



| FIG. NO. | SIZE | PRICE |
|----------|------|-------|
| 52366 | 3/8" | |
| 63848 | 1/2" | |

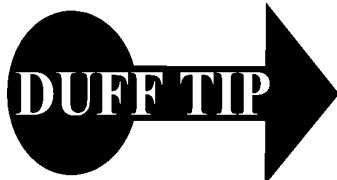

By using LOCK/BOLT ROD HANGERS and STEEL DROP-INS, you use smaller, less expensive drill bits than old fashioned lag shields and caulk-ins!

TOGGLE BOLT
SPRING WING TYPE

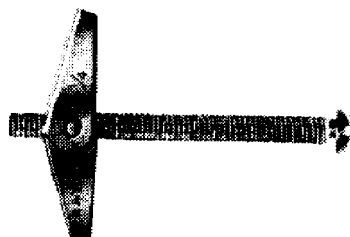

| SIZE | NO PER BOX | FIG NO | PRICE |
|----------|------------|--------|-------|
| 3/16 X 4 | 50 | 13682 | |
| 1/4 X 4 | 50 | 13683 | |
| 5/16 X 4 | 25 | 13685 | |
| 3/8 X 3 | 25 | 27735 | |



THIS ITEM IS EXCELLENT FOR USE WITH HOLLOW WALLS!

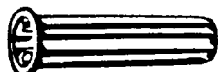

VINYL ANCHOR KITS



"Keep-Safe" collar prevents anchor from falling into over-size holes or hollow walls

*Raised ribs prevent turning in holes

*Flexible vinyl makes it an excellent anchor in concrete and block walls.

*Complete with anchors, screws & bit!

| ANCHOR SIZE | SCREW SIZE | NO PER BOX | DRILL INCL | FIG NO | PRICE |
|-------------|------------|------------|------------|--------|-------|
| 1/4 x 1 | #10 x 1 | 100 | YES | 37665 | |
| 5/16 x 1 | #14 x 1 | 50 | YES | 37664 | |

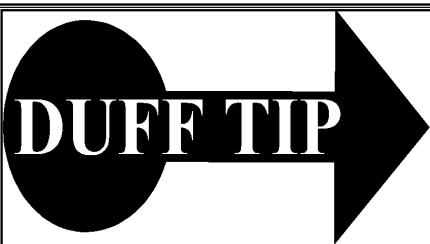

SEE TOOL SECTION FOR A SELECTION OF MILWAUKEE HAMMER DRILLS!

PLEASE CALL
US
FOR YOUR
NET PRICE!
610-275-4453

PERFORATED AND SLOTTED STEEL ANGLE

For permanent and temporary structural installations in your plant, warehouse or shop. Standard length is 10 foot.

| FIG NO | PRICE |
|--------|-------|
| 15349 | |

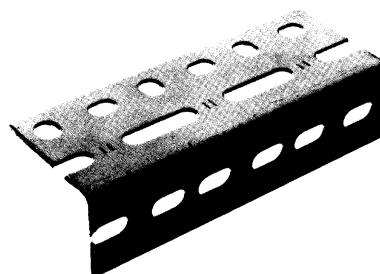

Stock size is 2 1/4"x1 1/2 x 10', double punched sides with single punched front. This angle allows double bolting for rigid, light weight construction. A pair of 3 foot horizontal beam will support an evenly distributed load of 550 lbs.

We've got an

ANGLE for you

SPACING OF HANGERS FOR STEEL PIPE

| Nominal Pipe Size, Inches | ½ | ¾ | 1 | 1¼ | 1½ | 2 | 2½ | 3 | 3½ | 4 | 5 | 6 | 8 | 10 | 12 | 14 | 16 | 18 | 20 | 24 |
|------------------------------|---|---|---|----|----|----|----|----|----|----|----|----|----|----|----|----|----|----|----|----|
| Maximum Span. Feet | 7 | 7 | 7 | 7 | 9 | 10 | 11 | 12 | 13 | 14 | 16 | 17 | 19 | 22 | 23 | 25 | 27 | 28 | 30 | 32 |
| Recommended Hanger Rod Sizes | ⅜ | ⅜ | ⅜ | ⅜ | ⅜ | ⅜ | ⅜ | ½ | ½ | ⅝ | ⅝ | ¾ | ⅞ | ⅞ | ⅞ | 1 | 1 | 1 | 1¼ | 1½ |
| OR TRAPEZE | | | | | | | | | | | | | | | | | | | | |

Note: Spacing and capacities are based on pipe filled with water. Additional valves and fittings increase the load and therefore closer hanger spacing is required.

*Many Codes and specifications require pipe hangers to be spaced every 10 feet regardless of size. Check local codes.

SPACING OF HANGERS FOR COPPER TUBING

| Tubing Size | ½ | ¾ | 1 | 1¼ | 1½ | 2 | 2½ | 3 | 3½ | 4 | 5 | 6 | 8 | 10 | 12 |
|-------------|---|---|---|----|----|----|----|----|----|----|----|----|----|----|----|
| Span in Ft. | 6 | 8 | 8 | 10 | 10 | 10 | 12 | 12 | 12 | 12 | 12 | 14 | 14 | 18 | 19 |

Note: Spacing and capacities are based on pipe filled with water. Additional valves and fittings increase the load and therefore closer hanger spacing is required.

SPACING OF HANGERS FOR PVC PLASTIC PIPE

| Schedule 40 Pipe Size | Support Spacings (In Feet) | | | | | | | | | |
|-----------------------|----------------------------|------|------|------|-------|-------|-------|-------|-------|-------|
| | Temperature | | | | | | | | | |
| | 20°F | 40°F | 60°F | 80°F | 100°F | 110°F | 120°F | 130°F | 140°F | 150°F |
| ½ to ¾ | 5.00 | 4.75 | 4.50 | 4.25 | 4.00 | 3.75 | 3.33 | 3.00 | 2.66 | 2.00 |
| 1 to 1¼ | 5.50 | 5.25 | 5.00 | 4.66 | 4.33 | 4.00 | 3.75 | 3.33 | 2.80 | 2.25 |
| 1½ to 2 | 5.80 | 5.50 | 5.25 | 5.00 | 4.66 | 4.33 | 3.80 | 3.50 | 3.00 | 2.50 |
| 2½ | 6.66 | 6.33 | 6.00 | 5.50 | 5.25 | 4.80 | 4.50 | 4.00 | 3.50 | 2.80 |
| 3 | 6.80 | 6.50 | 6.25 | 5.80 | 5.50 | 5.25 | 4.75 | 4.25 | 3.66 | 3.00 |
| 4 | 7.33 | 7.00 | 6.50 | 6.25 | 5.80 | 5.50 | 5.00 | 4.50 | 3.80 | 3.25 |
| 6 | 7.80 | 7.50 | 7.00 | 6.80 | 6.33 | 5.80 | 5.33 | 4.80 | 4.25 | 3.50 |

| Schedule 80 Pipe Size | Support Spacings (In Feet) | | | | | | | | | |
|-----------------------|----------------------------|------|------|------|-------|-------|-------|-------|-------|-------|
| | Temperature | | | | | | | | | |
| | 20°F | 40°F | 60°F | 80°F | 100°F | 110°F | 120°F | 130°F | 140°F | 150°F |
| ½ to ¾ | 5.75 | 5.50 | 5.25 | 4.80 | 4.50 | 4.33 | 3.80 | 3.50 | 3.00 | 2.50 |
| 1 | 6.33 | 6.00 | 5.75 | 5.33 | 5.00 | 4.60 | 4.33 | 3.80 | 3.33 | 2.75 |
| 1¼ to 1½ | 6.66 | 6.33 | 6.00 | 5.66 | 5.25 | 4.80 | 4.50 | 4.00 | 3.50 | 3.00 |
| 2 | 7.00 | 6.50 | 6.25 | 6.00 | 5.50 | 5.12 | 4.75 | 4.33 | 3.66 | 3.12 |
| 2½ | 7.80 | 7.50 | 7.00 | 6.66 | 6.33 | 5.80 | 5.33 | 4.75 | 4.25 | 3.33 |
| 3 | 8.20 | 7.75 | 7.33 | 7.00 | 6.50 | 6.00 | 5.50 | 5.00 | 4.33 | 3.50 |
| 4 | 8.66 | 8.25 | 7.80 | 7.33 | 6.80 | 6.33 | 5.80 | 5.25 | 4.66 | 3.75 |
| 6 | 9.80 | 9.33 | 8.80 | 8.33 | 7.80 | 7.33 | 6.50 | 6.00 | 5.12 | 4.25 |



"Call Duff!
We'll give you all the support you need!"
610-275-4453

OTHER HANGERS AVAILABLE FROM FACTORY STOCK



CONDUIT CLAMP
3/8 TO 2" PIPE



CARBON STEEL
TURNBUCKLE
1 1/4 TO 5" ROD



SPLIT RING



DOUBLE BOLT PIPE
CLAMP
3/4 TO 36"



OFFSET PIPE CLAMP



ADJUSTABLE
CLEVIS



EXTENDED CLAMP



ADJUSTABLE RING
1/2 TO 4" PIPE



ALLOY PIPE CLAMP

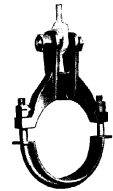

HEAVY DUTY ALLOY
PIPE CLAMP

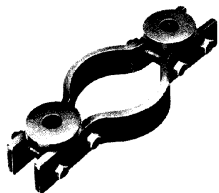

SOCKET CLAMP
4 TO 24" PIPE

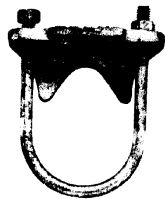

RIGHT ANGLE PIPE OR
CONDUIT CLAMP 1/2
TO 3" PIPE

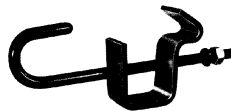

ADJUSTABLE BEAM
CLAMP 3/8 TO 5/8"
ROD

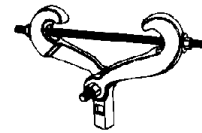

MALLEABLE BEAM
CLAMP

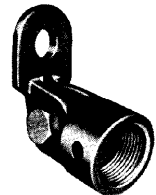

BRACE FITTING
1 & 1 1/4" IPS

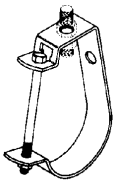

PIPE OR CONDUIT
HANGER 1/2 TO 6"
HANGER



FORGED STEEL
TURNBUCKLE 3/8
TO 2 1/2" ROD



SOCKET
1/4 TO 7/8" ROD



UNIVERSAL TRAPEZE
ASSEMBLY

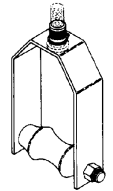

ADJUSTABLE STEEL
YOLK PIPE ROLL 2 1/2
TO 20" PIPE

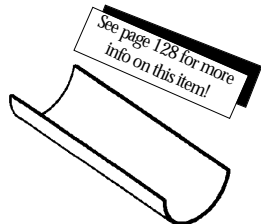

INSULATION
PROTECTION SHIELD

See page 128 for more info on this item!

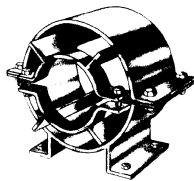

PIPE ALIGNMENT
GUIDE
3 TO 24" PIPE

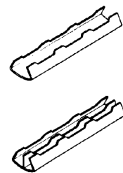

PIPE COVERING PRO-
TECTION
SADDLES

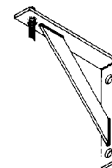

HEAVY WELDED
STEEL BRACKETS
MAX LOAD:3000LBS

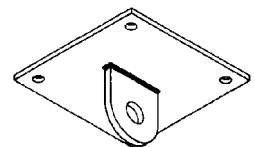

STRUCTURAL WELD-
ING LUG
1/2 TO 3 3/4" ROD



PIPE HANGER FLANGE
FOR 3/8 TO 2/4" ROD



CAST IRON CEILING
PLATE
1/2 TO 8" PIPE



ROD WITH EYE END
2 3/4 TO 5"



WELDLESS EYE NUT
3/8 TO 4" ROD

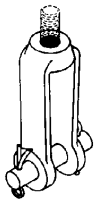

FORGED STEEL
CLEVIS
3/8 TO 4" ROD



TURNBUCKLE ADJUSTER
1/4 TO 3/4 ROD



EXTENSION PIECE
3/8 TO 78" ROD

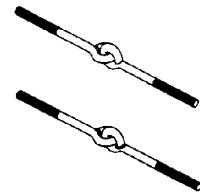

EYE RODS: WELDED
3/8 TO 2 1/2"

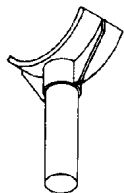

PIPE SADDLE SUPPORT
4 TO 12" PIPE

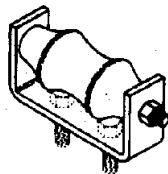

ROLLER CHAR
2 TO 20" PIPE

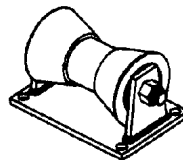

PIPE ROLL STAND COM-
PLETE
2 RO 42"

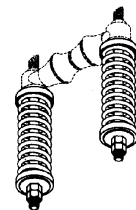

SPRING CUSHION FOR
ROLLS



**CALL DUFF FOR YOUR
SPECIAL ORDERS OF
NUTS, BOLTS AND
FASTENERS IN ALL
MATERIAL INCLUDING
STAINLESS!**

CUSTOM FABRICATION AND MACHINING OF ALL THERMOPLASTIC MATERIALS:

PVC

POLYETHYLENE

CPVC

PVDF

POLYPROPYLENE

TEFLON



IF YOU CAN DRAW IT, OR DESCRIBE IT,

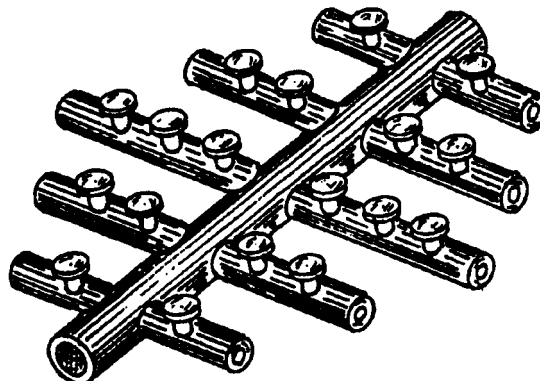

WE CAN MAKE IT!!!

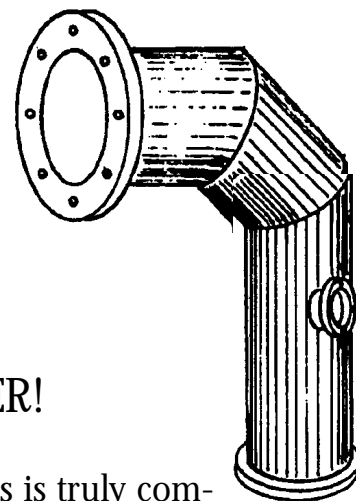
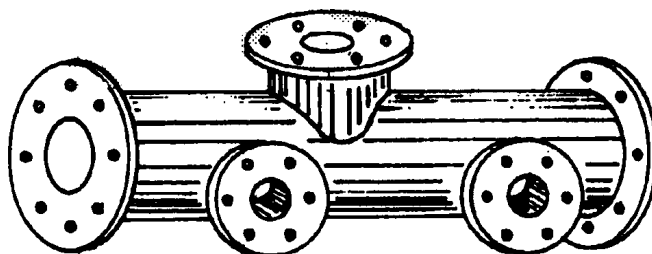

OUR GOAL...

TO ADDRESS THE TOTAL NEEDS OF OUR CUSTOMER!

We manufacture complete systems to your specifications! Plastinetics is truly committed to satisfying all your standard and non-standard needs with the highest quality product and courteous, efficient service!

Specialties include:

- Prefabricated Pipe Header Systems
- * Trough
- * Laundlers
- * Sinks
- * Table Tops
- * Underdrains
- * Pans
- * Transitions and much more!

WE ARE LIMITED ONLY BY YOUR IMAGINATION!

LOAD RATING THREADED ROD/MAX SPACING

| Nominal Rod Dia. (in inches) | Root Area Thread (in inches) ² | Max. Rec. Load/lbs. | |
|------------------------------|---|---------------------|-------|
| | | 650°F | 750°F |
| 1/4 | .027 | 240 | 210 |
| 3/8 | .068 | 610 | 540 |
| 1/2 | .126 | 1130 | 1010 |
| 5/8 | .202 | 1810 | 1610 |
| 3/4 | .302 | 2710 | 2420 |
| 7/8 | .419 | 3770 | 3360 |
| 1 | .552 | 4960 | 4420 |
| 1 1/8 | .693 | 6230 | 5560 |
| 1 1/4 | .889 | 8000 | 7140 |
| 1 1/2 | 1.293 | 11630 | 10370 |
| 1 3/4 | 1.744 | 15700 | 14000 |
| 2 | 2.300 | 20700 | 18460 |
| 2 1/4 | 3.023 | 27200 | 24260 |
| 2 1/2 | 3.719 | 33500 | 29880 |

WEIGHT PER LINEAR FOOT FOR PIPE AND WATER

| NOM. PIPE SIZE | WEIGHT OF: | | WEIGHT OF: | |
|----------------|------------|---------|------------|---------|
| | STD. PIPE | WATER | XS PIPE | WATER |
| 1/2 | .851 | .132 | 1.088 | .101 |
| 3/4 | 1.131 | .231 | 1.474 | .187 |
| 1 | 1.679 | .374 | 2.172 | .311 |
| 1 1/4 | 2.273 | .648 | 2.997 | .555 |
| 1 1/2 | 2.718 | .882 | 3.632 | .765 |
| 2 | 3.653 | 1.453 | 5.022 | 1.278 |
| 2 1/2 | 5.794 | 2.073 | 7.662 | 1.835 |
| 3 | 7.580 | 3.200 | 10.250 | 2.860 |
| 3 1/2 | 9.110 | 4.280 | 12.510 | 3.850 |
| 4 | 10.790 | 5.510 | 14.990 | 4.980 |
| 5 | 14.620 | 8.660 | 20.780 | 7.880 |
| 6 | 18.980 | 12.510 | 28.580 | 11.290 |
| 8 | 28.560 | 21.680 | 43.400 | 19.800 |
| 10 | 40.500 | 34.100 | 54.700 | 32.300 |
| 12 | 49.600 | 49.000 | 65.400 | 47.000 |
| 14 | 54.600 | 59.700 | 72.100 | 57.500 |
| 16 | 62.600 | 79.100 | 82.800 | 76.500 |
| 18 | 70.600 | 101.200 | 93.500 | 98.300 |
| 20 | 78.600 | 126.000 | 104.100 | 122.800 |
| 24 | 94.600 | 183.800 | 125.500 | 179.900 |
| 30 | 118.700 | 291.000 | 157.600 | 286.000 |

DRILL SIZES FOR PIPE TAPS

| SIZE OF TAP | NUMBER OF THREADS PER INCH | DIAM. OF DRILL | SIZE OF TAP | NUMBER OF THREADS PER INCH | DIAM. OF DRILL |
|-------------|----------------------------|----------------|-------------|----------------------------|----------------|
| 1/8 | 27 | 1/32 | 2 | 11 1/2 | 2 3/16 |
| 1/4 | 18 | 7/64 | 2 1/2 | 8 | 2 1/16 |
| 3/8 | 18 | 3/64 | 3 | 8 | 3 3/16 |
| 1/2 | 14 | 2 3/32 | 3 1/2 | 8 | 3 11/16 |
| 3/4 | 14 | 5/64 | 4 | 8 | 4 3/16 |
| 1 | 11 1/2 | 1 3/32 | 4 1/2 | 8 | 4 3/4 |
| 1 1/4 | 11 1/2 | 1 1/2 | 5 | 8 | 5 3/16 |
| 1 1/2 | 11 1/2 | 1 3/4 | 6 | 8 | 6 3/16 |

TAP AND DRILL SIZES (American Standard Coarse)

| SIZE OF DRILL | SIZE OF TAP | THREADS PER INCH | SIZE OF DRILL | SIZE OF TAP | THREADS PER INCH |
|---------------|-------------|------------------|---------------|-------------|------------------|
| 7 | 1/4 | 20 | 4 9/64 | 7/8 | 9 |
| F | 5/16 | 18 | 5 3/64 | 1 1/16 | 9 |
| 3/16 | 3/8 | 16 | 7/8 | 1 | 8 |
| U | 7/16 | 14 | 6 3/64 | 1 1/8 | 7 |
| 7/64 | 1/2 | 13 | 1 3/64 | 1 1/4 | 7 |
| 3 1/64 | 5/8 | 12 | 1 13/64 | 1 3/8 | 6 |
| 1 1/32 | 5/8 | 11 | 1 11/32 | 1 1/2 | 6 |
| 1 1/32 | 1 1/16 | 11 | 1 29/64 | 1 5/8 | 5 1/2 |
| 2 1/32 | 3/4 | 10 | 1 1/16 | 1 3/4 | 5 |
| 2 3/32 | 1 1/16 | 10 | 1 11/16 | 1 7/8 | 5 |
| | | | 1 25/32 | 2 | 4 1/2 |

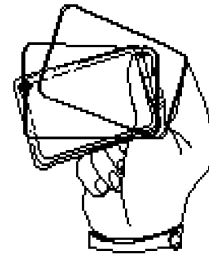

**DUFF
GLADLY
ACCEPTS
VISA AND
MASTERCARD**

FIRE PROTECTION

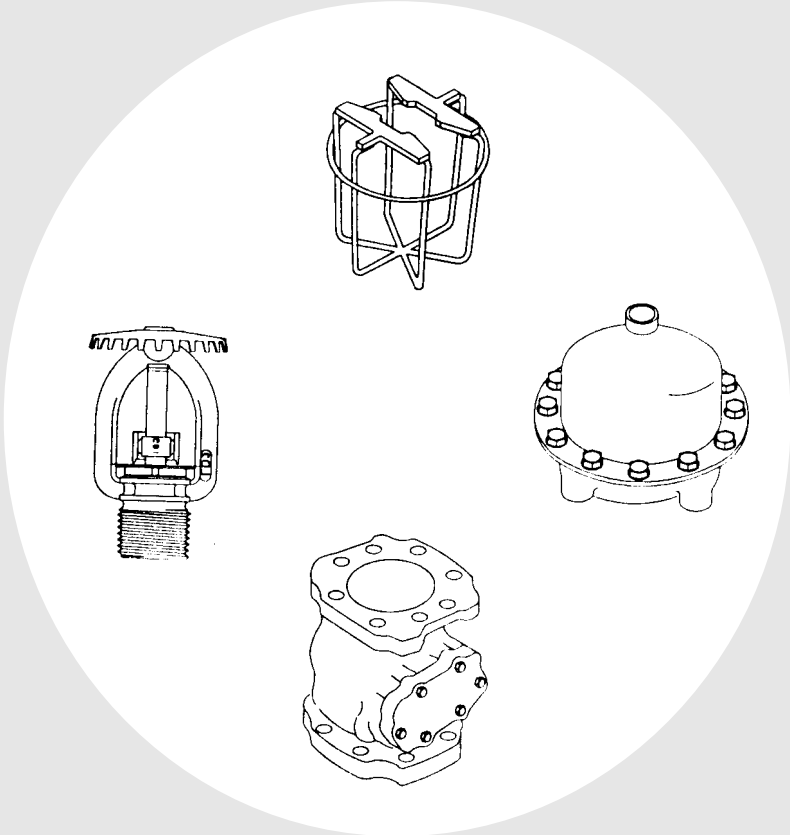

FIRE PROTECTION

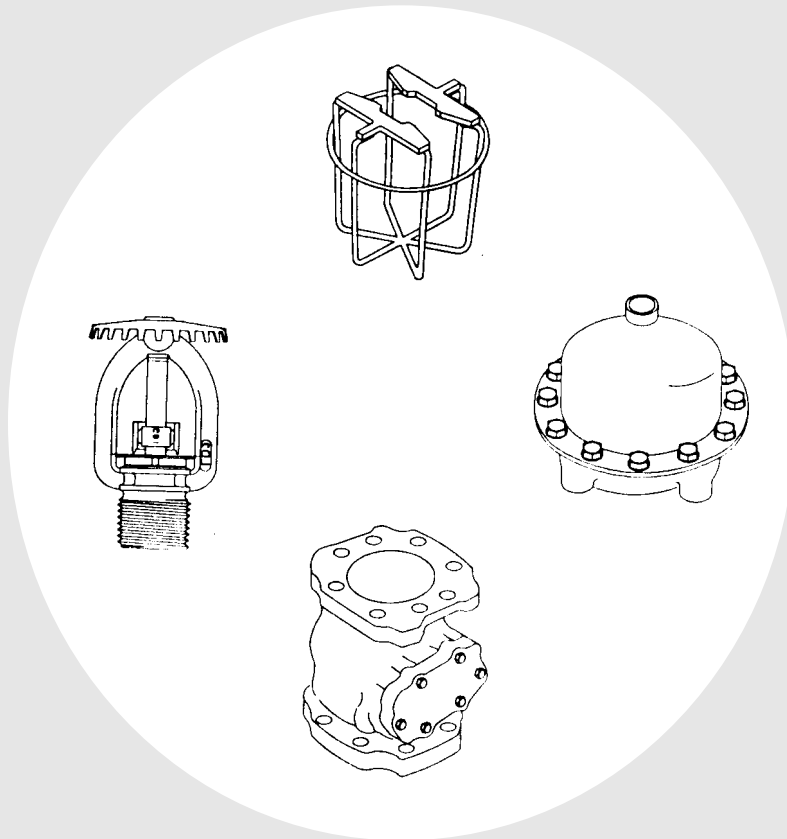

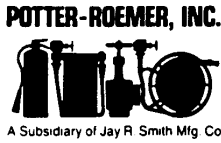

EXPOSED FIRE DEPT. INLET CONNECTIONS — CLAPPER TYPE

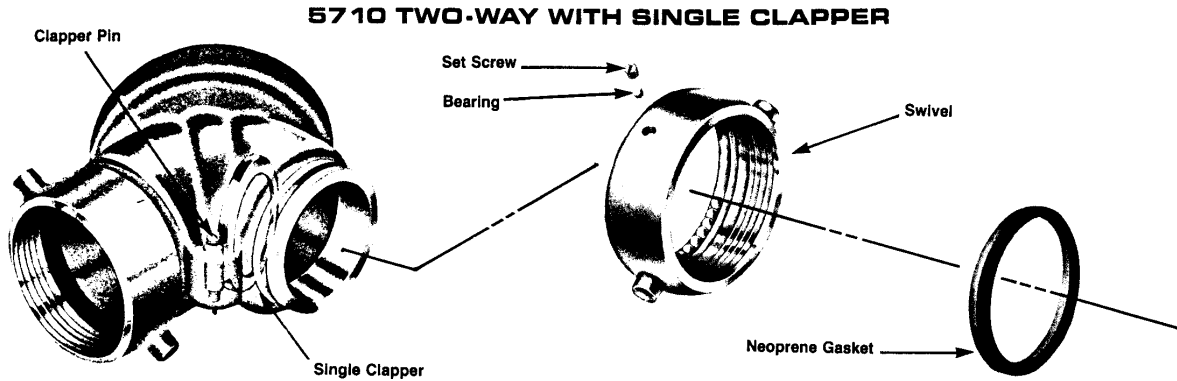

6710 TWO-WAY WITH SINGLE CLAPPER

TWO-WAY WITH SINGLE CLAPPER

FUNCTION: Used as an auxiliary inlet connection providing 500 G.P.M. minimum (Ref. NFPA No. 14) to supplement the fire protection water supply. Swing clapper provides unobstructed waterway. Exposed design is an economical method of satisfying fire dept. inlet requirements.

REGULARLY FURNISHED: Cast brass two-way inlet body, swing clapper and pin lug swivel. Back or angle outlet as selected by figure number. Lettering as selected. Size 4" x 2 1/2" x 2 1/2".

OPTIONAL FINISHES:

- B Polished Brass
- C Rough Chrome Plated
- D Polished Chrome Plated

LETTERING AVAILABLE:

AUTO. SPKR.
STANDPIPE

SPECIFY thread and lettering

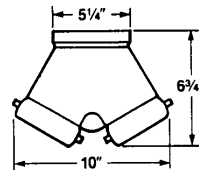
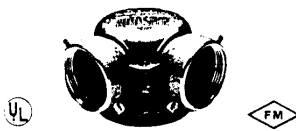

FIG. NO. 88221 BACK OUTLET
4 X 2 1/2

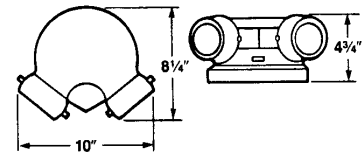

FIG. NO. 88222 ANGLE OUTLET
4 X 2X2 1/2

TWO-WAY WITH DOUBLE CLAPPERS

FUNCTION: Used as an auxiliary inlet connection providing 500 G.P.M. minimum (Ref. NFPA No. 14) to supplement the fire protection water supply. Drop clappers provide unobstructed waterway. Exposed design is an economical method of satisfying fire dept. inlet requirements.

REGULARLY FURNISHED: Cast brass two-way inlet body, drop clappers and pin lug swivels. Size and outlet as selected by figure number. Lettering as selected.

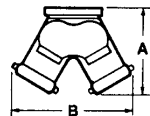

FIG. NO. 87876-87879
Back Outlet

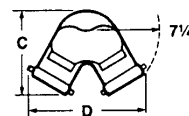

FIG. NO. 87881-87884
90° Angle Outlet

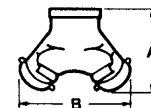

FIG. NO. 87880
45° Angle Outlet

| Outlet Locations | Angle | Size | A | B | C | D |
|------------------|-----------|-----------------------|-------|--------|--------|--------|
| Back | | | | | | |
| Fig. No. | Fig. No. | | | | | |
| 87876 | 87881 | 4 1/2 x 2 1/2 x 2 1/2 | 7 1/2 | 11 1/2 | 8 1/2 | 11 1/4 |
| 87877 | 87882 | 6 x 2 1/2 x 2 1/2 | 9 1/2 | 10 1/2 | 9 | 10 3/4 |
| 87878 | 87883 | 4 x 3 x 3 | 9 1/2 | 11 1/2 | 9 1/2 | 11 |
| 87879 | 87884 | 6 x 3 x 3 | 10 | 11 | 10 1/2 | 11 |
| 87880 | 45° Angle | 4 x 2 1/2 x 2 1/2 | 8 | 11 | — | — |

ALL DIMENSIONS IN INCHES

OPTIONAL FINISHES:

- B Polished Brass
- C Rough Chrome Plated
- D Polished Chrome Plated

LETTERING AVAILABLE:

AUTO. SPKR.
STANDPIPE

SPECIFY thread and lettering

NON-ADJUSTABLE REG-U-MATIC PRESSURE REGULATING VALVES

TYPICAL NON-ADJUSTABLE PRESSURE REGULATING VALVE (4050 SHOWN)

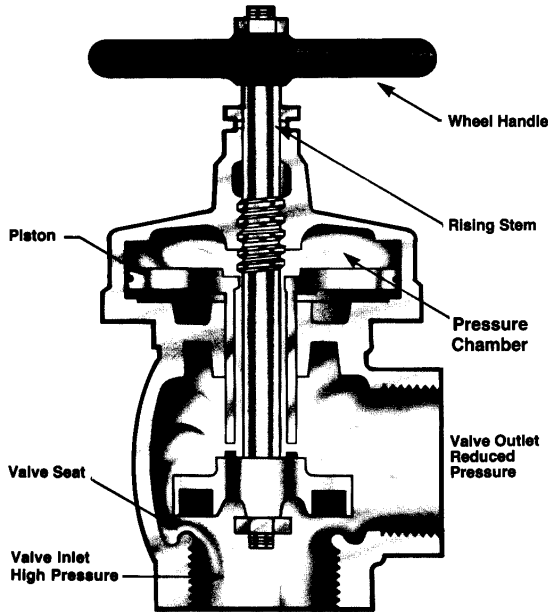

FEATURES AND DATA

- Selected pressure control under residual and static conditions.
- Selected pressure control for 20 to 400 P.S.I.
- Listed by Underwriters Laboratories at 400 P.S.I. pressure.
- Listed by Underwriters Laboratories as a checking device.
- Hydraulic piston design.
- Under low residual supply pressure valve fully opens.
- Complete piping system can be hydrostatically tested to 400 P.S.I. without damage to valve.
- Maximum back pressure does not damage valve components.
- Tamper Proof Pressures.
- Monitor Switch Adapter to provide valve supervision.
- Designed for high pressure sprinkler, standpipe and combined fire protection systems.

ORDERING INFORMATION

- Select type and size by figure number.
- Select required pressure range. (See Appendix page VI)
- Select hose thread for male outlets.
- Optional Finish: -C Rough Chrome Plated.
- For factory selection of proper application advise
 1. Valve inlet P.S.I. Residual.
 2. G.P.M. Flow requirement.
 3. Valve outlet P.S.I. requirement.

VALVE SELECTION CHARTS AVAILABLE SEE APPENDIX PAGE IV
1 1/2" VALVE LISTED AT 300 P.S.I. PRESSURE

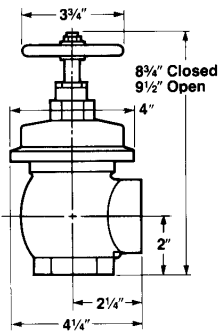

1 1/2" FEMALE x FEMALE

FUNCTION: Used as a hose station control to regulate inlet pressure to 300 P.S.I. Also may be used as a zone control valve to regulate high pressure sprinkler, standpipe and combined systems with flow up to 250 G.P.M.

REGULARLY FURNISHED: Cast brass valve with rising stem, internal parts of brass and stainless steel, aluminum handwheel. Female NPT inlet and outlet.

OPTION: - MSA Monitor Switch Adapter with Visual Indicator.

| FIG NO | PRICE |
|--------|-------|
| 83684 | |

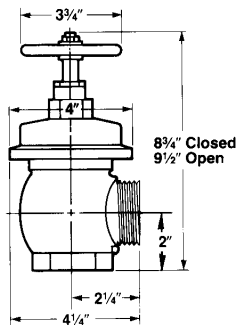

1 1/2" FEMALE x MALE

FUNCTION: Used as a hose station to regulate inlet pressure to 300 P.S.I.

REGULARLY FURNISHED: Cast brass valve with rising stem, internal parts of brass and stainless steel, aluminum handwheel. Female NPT inlet x male hose thread outlet.

OPTION: - MSA Monitor Switch Adapter with Visual Indicator.

| FIG NO | PRICE |
|--------|-------|
| 83685 | |

NOTE: ALWAYS INDICATE HOSE THREAD REQUIREMENTS.

**NON-ADJUSTABLE REG-U-MATIC
PRESSURE REGULATING VALVES
PRESSURE RELIEF VALVE**

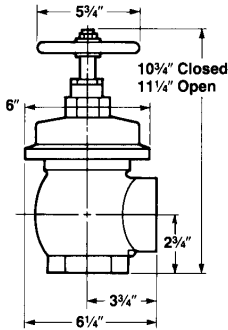

2 1/2" FEMALE x FEMALE

FUNCTION: Used as a zone control valve for in-line application to regulate high pressure sprinkler, standpipe and combined systems. The valve is used to regulate inlet pressure to 400 P.S.I.

REGULARLY FURNISHED: Cast brass valve with rising stem. Internal parts of brass and stainless steel, aluminum handwheel. Female NPT inlet and outlet.

OPTION: - MSA Monitor Switch Adapter with Visual Indicator.

| FIG NO | PRICE |
|--------|-------|
| 83686 | |

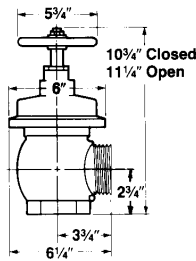

2 1/2" FEMALE x MALE

FUNCTION: Used as a control and regulating valve for fire service end of line application on high pressure sprinkler, standpipe and combined systems. The valve is used to regulate inlet pressure to 400 P.S.I.

REGULARLY FURNISHED: Cast brass valve with rising stem, internal parts of brass and stainless steel, aluminum handwheel. Female NPT inlet x male hose thread outlet.

OPTION: - MSA Monitor Switch Adapter with visual indicator.

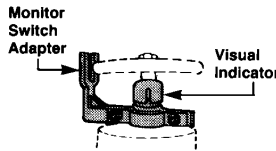

| FIG NO | PRICE |
|--------|-------|
| 83687 | |

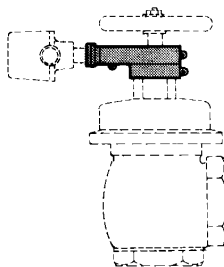

**TAMPER PROOF MONITOR
SWITCH ADAPTER**

FUNCTION: Used with 4050 and 4053 valves to provide totally enclosed valve supervision.

REGULARLY FURNISHED: Cast aluminum bracket with mounting bolts and instructions.

| FIG NO | PRICE |
|--------|-------|
| 83688 | |

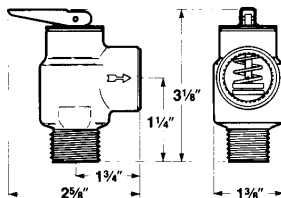

**AUTOMATIC
FIRE SPRINKLER SYSTEM
PRESSURE RELIEF VALVE**

FUNCTION: Used downstream from a pressure regulating valve to protect system components from high pressure surges.

REGULARLY FURNISHED: Cast brass valve with 3/4" N.P.T. male inlet x 3/4" N.P.T. female outlet.

PRESSURE SETTING AVAILABLE: 15 through 175 P.S.I.

SPECIFY: Setting

OPTIONAL: -C Rough Chrome Plated.

| FIG NO | PRICE |
|--------|-------|
| 83689 | |

NOTE: ALWAYS INDICATE HOSE THREAD REQUIREMENTS.

HOSE VALVES

ANGLE

FEMALE X MALE

FUNCTION: Used with a fire hose rack assembly or as a fire dept. outlet connection.

REGULARLY FURNISHED: Cast brass valve with red hand wheel. Female N.P.T. inlet X male hose thread outlet. 300 lb.

| SIZE | FIG NO | PRICE |
|-------|--------|-------|
| 1 1/2 | 76302 | |
| 2 1/2 | 59115 | |

SPECIFY thread

OPTIONAL FINISHES:

- B Polished Brass
- C Rough Chrome Plated
- D Polished Chrome Plated

VARIATIONS:

Extended stem up to 24", **SPECIFY** length
 1/8" petcock **SPECIFY** location

| Size | Closed | | Open | | D | E |
|-------|--------|-------|-------|--------|-------|-------|
| | A | B | C | C | | |
| 1 1/2 | 2 1/4 | 3 1/2 | 6 1/2 | 7 1/2 | 2 1/2 | 2 |
| 2 1/2 | 3 1/2 | 5 | 9 1/2 | 11 1/2 | 3 1/2 | 2 3/4 |

ALL DIMENSIONS IN INCHES

DOUBLE FEMALE

FUNCTION: Used with a fire hose rack assembly.

REGULARLY FURNISHED: Cast brass valve with red hand wheel. Female N.P.T. inlet and outlet. 300 lb. rated

| SIZE | FIG NO | PRICE |
|-------|--------|-------|
| 1 1/2 | 83690 | |
| 2 1/2 | 83692 | |

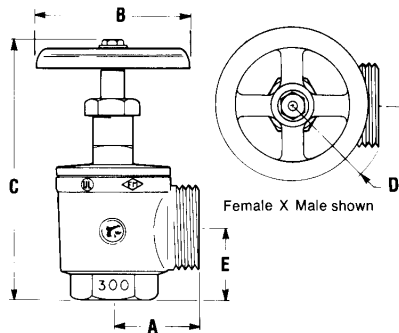

ADJUSTABLE PRESSURE RESTRICTING ANGLE VALVE

FEMALE X MALE

FUNCTION: Used with a fire hose rack assembly or as a fire dept. outlet connection. Water pressure is controlled by adjustable flow restriction. If full flow is required the restriction may be overridden.

REGULARLY FURNISHED: Cast brass valve with red hand wheel with pressure restricting feature. Female N.P.T. inlet X male hose thread outlet. 300 lb. rated. Furnished with field setting chart.

| SIZE | FIG NO | PRICE |
|-------|--------|-------|
| 1 1/2 | 83693 | |
| 2 1/2 | 83694 | |

DOUBLE FEMALE

FUNCTION: Used with a fire hose rack assembly. Water pressure is controlled by adjustable flow restriction. If full flow is required the restriction may be overridden.

REGULARLY FURNISHED: Cast brass valve with red hand wheel with pressure restricting feature. Female N.P.T. inlet and outlet. 300 lb. rated. Furnished with field setting chart.

| SIZE | FIG NO | PRICE |
|-------|--------|-------|
| 1 1/2 | 83695 | |
| 2 1/2 | 83696 | |

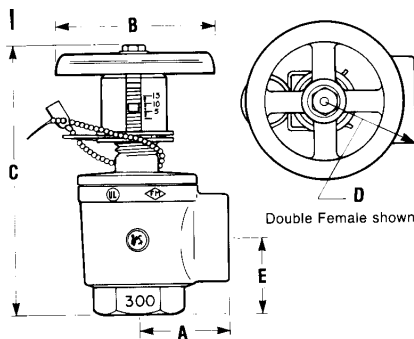

HOSE VALVES

STRAIGHT GLOBE

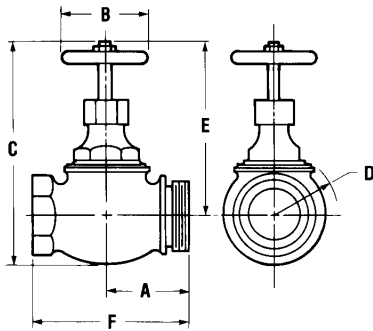

FEMALE X MALE

FUNCTION: Used with a fire hose assembly or as a fire dept. outlet connection.

REGULARLY FURNISHED:

Cast brass valve with red hand wheel. Female N.P.T. inlet X male hose thread outlet. 300 P.S.I.

VARIATION:

Extended stem up to 24", SPECIFY length

| Size | Closed | | Open | | D | E | F |
|-------|--------|-------|--------|--------|-------|-------|-------|
| | A | B | C | C | | | |
| 1/2 | 1/8 | 2 | 4 | 4 1/4 | 1 | 3 3/8 | 2 1/4 |
| 1 1/2 | 2 1/2 | 3 1/2 | 7 1/4 | 8 1/4 | 3 | 5 3/4 | 4 3/4 |
| 2 1/2 | 3 1/2 | 5 | 10 1/4 | 11 1/4 | 3 1/2 | 8 1/4 | 7 |

ALL DIMENSIONS IN INCHES

DOUBLE FEMALE

FUNCTION: Used with a fire hose rack assembly or as a drain valve.

REGULARLY FURNISHED:

Cast brass valve with red hand wheel. Female N.P.T. inlet and outlet. 300 P.S.I.

| SIZE | FIG NO | PRICE |
|-------|--------|-------|
| 1/2 | 83700 | |
| 1 1/2 | 83701 | |
| 2 1/2 | 83702 | |

OPTIONAL FINISHES:

- B Polished Brass
- C Rough Chrome Plated
- D Polished Chrome Plated

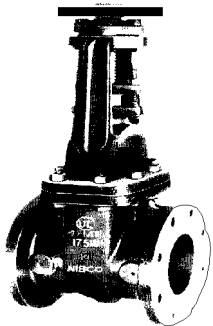

FIG. NO. DCF607OTS

- * 175 LB WWP Iron Body Gate
- * Flanged
- * UL8/ULC listed
- * FM approved
- * Bolted bonnet
- * Outside screw and yoke
- * Solid wedge
- * Pre-grooved stem for tamper switch mounting.
- * 175 psi non-shock cold water
- * Approved by the New York City board of Standards and Appeals

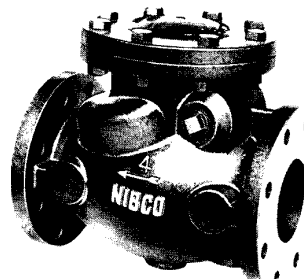

FIG. NO. DCF908W

- * 175 LB WWP iron body check
- * Flanged
- * UL/ULC listed
- * FM approved
- * Bolted bonnet
- * Horizontal Swing
- * Renewable seat and disc
- * 175 PSI non-shock cold water
- * Approved by the New York City board of Standards and Appeals

HOSE RACKS
HOSE ADAPTERS
FIRE DEPT INLET CONNECTIONS
PORTABLE FIRE EXTINGUISHERS
ALL AVAILABLE
CALL DUFF NOW!
610-275-4453

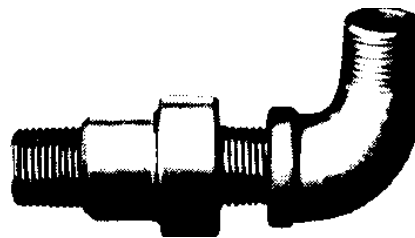

FIG. NO. DCBALLDRIP

- * 1/2" Automatic Ball Drip
- * For installation on DCF908W
- * Closes against pressure
- * Opens when pressure is off, allowing water to drain from the fire department connection

HOSE GATE VALVES

WITH RISING STEM

FUNCTION: Used as a fire dept. outlet connection, designed for dry systems only. Unrestricted water way allows full flow. Suitable for use as a pump test valve.

REGULARLY FURNISHED: Cast brass valve with rising stem, red hand wheel. Female N.P.T. inlet x male hose thread outlet. Brass solid wedge disc and tapered set.

- OPTIONAL FINISHES:**
 -B Polished Brass
 -C Rough Chrome Plated
 -D Polished Chrome Plated

SPECIFY thread

| Size | Pressure | Closed Open | | | | | | |
|---------|----------|-------------|--------|--------|--------|-------|-------|-------|
| | | A | B | C | C | D | E | F |
| 2 1/2 | 200 lb. | 5 3/4 | 12 1/2 | 15 | 17 1/2 | 2 1/2 | 4 1/2 | 5 3/4 |
| 3x2 1/2 | 300 lb. | 6 1/4 | 12 1/2 | 15 | 18 | 2 1/2 | 4 1/2 | 5 3/4 |
| 3 | 300 lb. | 7 1/2 | 14 1/2 | 17 1/2 | 21 | 3 | 5 1/2 | 7 |

ALL DIMENSIONS IN INCHES

| SIZE | FIG NO | PRICE |
|---------|--------|-------|
| 2 1/2 | 83703 | |
| 3X2-1/2 | 83704 | |
| 3 | 83705 | |

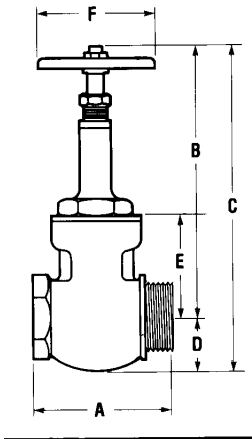

WITH NON-RISING STEM

FUNCTION: Used as a fire dept. outlet connection, designed for dry systems only. Unrestricted water way allows full flow. Suitable for use as a pump test valve. Non-rising stem feature requires less installation space.

REGULARLY FURNISHED: Cast brass valve with non-rising stem, red hand wheel. Female N.P.T. inlet x male hose thread outlet. Brass solid wedge disc and tapered seat.

- OPTIONAL FINISHES:**
 -B Polished Brass
 -C Rough Chrome Plated
 -D Polished Chrome Plated

SPECIFY thread

| Size | Pressure | Closed Open | | | | | |
|---------|----------|-------------|-------|-------|-------|-------|-------|
| | | A | B | C | D | E | F |
| 1 1/2* | 200 lb. | 5 | 6 | 7 1/2 | 1 1/2 | 2 1/2 | 3 1/4 |
| 2 1/2 | 300 lb. | 5 1/4 | 7 3/4 | 9 3/4 | 2 | 3 1/2 | 5 1/4 |
| 3x2 1/2 | 300 lb. | 5 1/4 | 7 3/4 | 9 3/4 | 2 | 3 1/2 | 5 1/4 |

ALL DIMENSIONS IN INCHES

| SIZE | FIG NO | PRICE |
|---------|--------|-------|
| 1 1/2 | 83706 | |
| 2 1/2 | 83707 | |
| 3X2 1/2 | 83708 | |

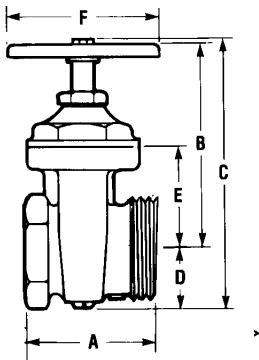

*NOT U/L LISTED

CAPS AND CHAINS

FUNCTION: Use to cover and protect male threads on valves and hydrants. Discourages entry of foreign matter.

REGULARLY FURNISHED: Cast brass cap with female hose thread, pin lugs and chain.

| SIZE | FIG NO | PRICE |
|--------|--------|-------|
| 3/4" | 83709 | |
| 1" | 83710 | |
| 1 1/2" | 88224 | |
| 2 1/2" | 83711 | |
| 3" | 83712 | |
| 4" | 83713 | |

- OPTIONAL FINISHES:**
 -B Polished Brass
 -C Rough Chrome Plated
 -D Polished Chrome Plated

VARIATIONS: with rocker lugs (suffix -RL)
 2 1/2" and 3" size available in plastic (suffix -P)

SPECIFY: Thread.

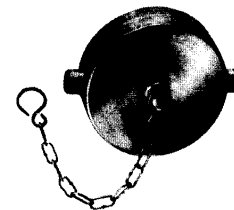

FIRE SPRINKLERS

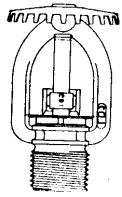

UPRIGHT SPRINKLER HEAD

| DESC | FIG. NO. | PRICE |
|---------|----------|-------|
| 165° BR | 10535 | |
| 165° CP | 10542 | |
| 212° BR | 37465 | |
| 286° BR | 37445 | |

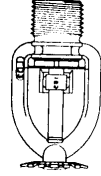

PENDANT SPRINKLER HEAD

| DESC | FIG. NO. | PRICE |
|---------|----------|-------|
| 165° BR | 10540 | |
| 165° CP | 10547 | |
| 212° BR | 36543 | |
| 212° CP | 36544 | |
| 286° BR | 37440 | |



SIDEWALL SPRINKLER

| DESC | FIG. NO. | PRICE |
|---------|----------|-------|
| 165° CP | 10560 | |

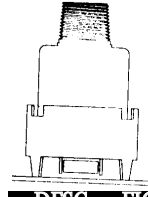

PHANTOM SPRINKLER

| DESC | FIG. NO. | PRICE |
|------------|----------|-------|
| 165° | 28178 | |
| Cover Only | 25436 | |

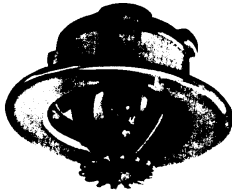

RECESSED SPRINKLER HEAD

| DESC | FIG. NO. | PRICE |
|-----------|----------|-------|
| W/ Trim | 17625 | |
| Less Trim | 55982 | |

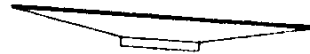

FLAT ESCUTCHEON

| FIG. NO. | PRICE |
|----------|-------|
| 10566 | |

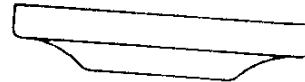

STANDARD SPRINKLER ESCUTCHEON

| FIG. NO. | PRICE |
|----------|-------|
| 10568 | |

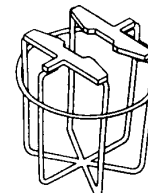

SPRINKLER HEAD GUARD

| DESC | FIG. NO. | PRICE |
|---------------|----------|-------|
| Red | 10570 | |
| Chrome Plated | 10572 | |

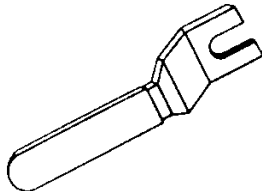

SPRINKLER HEAD WRENCH

| FIG. NO. | PRICE |
|----------|-------|
| 10558 | |



1/4" PRESSURE GAUGE VALVE

| FIG. NO. | PRICE |
|----------|-------|
| 62355 | |



WATERFLOW DETECTORS

| SIZE | FIG. NO. | PRICE |
|--------|----------|-------|
| 2" | DCVSRF2 | |
| 2 1/2" | DCVSRF21 | |
| 3" | DCVSRF3 | |
| 4" | DCVSRF4 | |
| 5" | DCVSRF5 | |
| 6" | DCVSRF6 | |

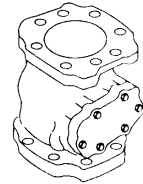

ALARM VALVE, MODEL E, MODEL F

| FIG. NO. | PRICE |
|----------|-------|
| DCALARM1 | |

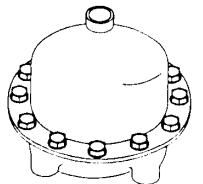

MODEL D RETARD CHAMBER

| FIG. NO. | PRICE |
|----------|-------|
| DCRETARD | |



WATER MOTOR ALARM

| FIG. NO. | PRICE |
|----------|-------|
| DCALARM | |

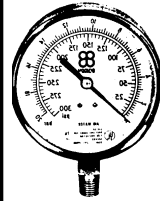

AIR & WATER GAUGE. Designed for use on all Grunau Fire protection systems for convenient pressure readings.

Scaled in both PSI and bars.

| FIG. NO. | PRICE |
|----------|-------|
| 45165 | |

SPRINKLER HEAD COLOR CODES

| | |
|------|--------|
| 135° | BLACK |
| 165° | BRONZE |
| 212° | WHITE |
| 280° | BLUE |
| 360° | RED |

CALL US FOR MORE INFORMATION!









FIRE STOPS

SELECTION

Firestops are comprised of three essential inter-related components: the penetrated barrier, the penetrants, and the seal used to close the opening between the penetrants and the barrier. The firestopping seal is the last of the three components to be installed. Good planning can make firestopping simpler, more cost effective and safer.

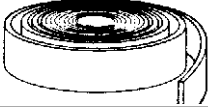
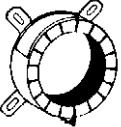
1. Select penetrants that have published firestop systems available.
2. Require a suitable annulus for installation of the appropriate firestop system.
3. Require sufficient spacing of penetrants from each other and other building elements.
4. Consider the environment of the installations and select an appropriate material and method.

SELECTOR GUIDE

| | | | | |
|----------|---|--|--|---|
| 1 | Large openings through concrete floors & walls | Cable trays Bus Duct Multiple Pipes Insulated Pipes Plastic Pipes | FIRE RATED MORTAR Series SSM |  |
| 2 | Medium to small openings in all constructions | Metallic Pipes Cable Trays Multiple Pipes Plastic Pipes Loose Cables Bus Duct Insulated Pipes | INTUMESCENT SEALANT Series SSS |  |
| 3 | Small to medium openings - all constructions | Metallic Pipes Metallic Pipes through sleeves Electrical or telephone cable | LATEX SEALANT Series LC150 |  |
| 4 | Small openings in all constructions (easy retrofit) | Metallic Pipes Loose cables | INTUMESCENT PUTTY Series SSP |  |
| 5 | Combustible penetrants field fabricated | Insulated pipes Plastic Pipes | OMTUMESCENT WRAP STRIPS All wrap strips |  |
| 6 | Combustible penetrants factory manufactured | Plastic pipes | INTUMESCENT COLLARS Series SSC |  |
| 7 | Medium to large openings (easy retrofit) | Cable tray Power, Voice, Data cables Fan Coils | FIRESTOP PILLOWS Series SSB |  |
| 8 | Large openings through concrete floors & walls | Cable trays Bus Duct Multiple pipes Insulated pipes Plastic pipes | SILICONE FOAM Series PEN200 |  |
| 9 | Construction joints, pipe with high temperature or movement | Metallic, steam pipes Safing & construction gaps Seismic joints | SILICONE SEALANT Series PEN300 |  |

SEE FOLLOWING PAGE FOR FIGURE NUMBERS AND PRICING

NOTE: Product shown is primary one to be used for application. Additional product(s) may be required.

FIRE STOPS

| REF | FIG. NO. | DESCRIPTION | SIZE / WGHT | PRICE |
|----------|----------|------------------------------------|----------------|-------|
| 1 | 73588 | SSM106 Firestop Mortar | 6 Gal | |
| | 73589 | SSM22B Firestop Mortar | 22 lb. | |
| 2 | 73571 | SSS100 Red Latex Sealant | 10.5 oz. | |
| | 73573 | SSS102 Red Latex Sealant | 2 Gal. | |
| | 73574 | SSS105 Red Latex Sealant | 5 Gal. | |
| 3 | 73575 | LC150 Green Latex Sealant | 10.5 oz. | |
| | 73576 | LC152 Green Latex Sealant | 2 Gal. | |
| | 73577 | LC155 Green Latex Sealant | 5 Gal. | |
| 4 | 73581 | SSP100 Instrumescent Putty Tube | | |
| 5 | 74932 | SSWRED Intumescent Red Wrap | | |
| 6 | 73582 | SSC151 1 1/2" Instrumescent Collar | | |
| | 73584 | SSC202 2" Instrumescent Collar | | |
| | 73585 | SSC301 3" Instrumescent Collar | | |
| | 73586 | SSC400 4" Instrumescent Collar | | |
| | 73587 | SSC600 6" Instrumescent Collar | | |
| 7 | 73590 | SSB14 Firestop Pillow | 1x4x9 | |
| | 73591 | SSB24 Firestop Pillow | 2x4x9 | |
| | 73592 | SSB26 Firestop Pillow | 2x6x9 | |
| | 75850 | SSB36 Firestop Pillow | 3x6x9 | |
| 8 | 83964 | PEN200 Silicone Foam | 100 lb. | |
| 9 | 73578 | PEN300 Silicone Sealant | 10.3 oz. | |
| | 73579 | PEN302 Silicone Sealant | 2 Gal. | |
| | 73580 | PEN305 Silicone Sealant | 5 Gal. | |

COUPLINGS FOR GROOVED-END PIPE

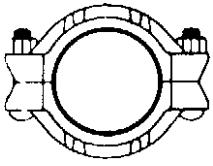

Standard coupling

| FIG. NO. | PRICE |
|----------|-------|
| D7001 | |

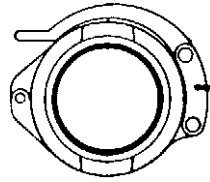

Hingelok Coupling

| FIG. NO. | PRICE |
|----------|-------|
| D7003 | |

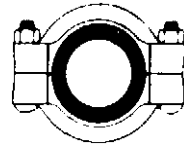

Reducing Coupling

| FIG. NO. | PRICE |
|----------|-------|
| D7010 | |

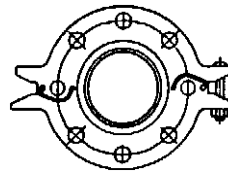

Gruvlok 300# flange

| FIG. NO. | PRICE |
|----------|-------|
| D7013 | |

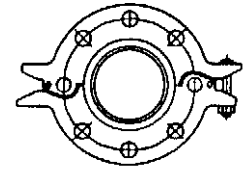

2" — 12"

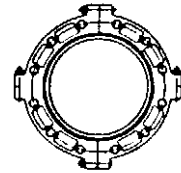

14" — 24"

Gruvlok Flange

| FIG. NO. | PRICE |
|----------|-------|
| D7012 | |

GROOVED END FITTINGS

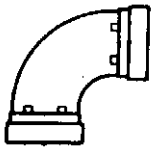

90 Deg. Bend

| FIG. NO. | PRICE |
|----------|-------|
| D7050 | |



45 Deg. Bend

| FIG. NO. | PRICE |
|----------|-------|
| D7051 | |



22 1/2 Deg. Bend

| FIG. NO. | PRICE |
|----------|-------|
| D7052 | |



11 1/4 Deg. Bend

| FIG. NO. | PRICE |
|----------|-------|
| D7053 | |

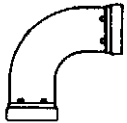

Long radius
90 deg. elbow

| FIG. NO. | PRICE |
|----------|-------|
| D7050LR | |



Long radius
45 deg. elbow

| FIG. NO. | PRICE |
|----------|-------|
| D7051 | |



Groove X M
90 deg. elbow

| FIG. NO. | PRICE |
|----------|-------|
| D7055 | |



Groove X M
45 deg. elbow

| FIG. NO. | PRICE |
|----------|-------|
| D7056 | |

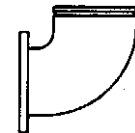

Reducing base support
elbow

| FIG. NO. | PRICE |
|----------|-------|
| D7050RF | |

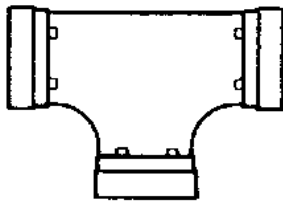

Groove Tee

| FIG. NO. | PRICE |
|----------|-------|
| D7060 | |

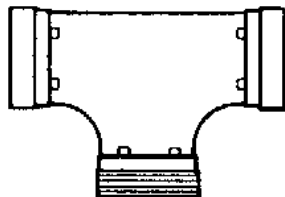

Groove tee with threaded
branch

| FIG. NO. | PRICE |
|----------|-------|
| D7063 | |

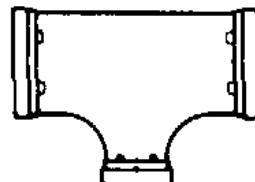

Reducing Tee

| FIG. NO. | PRICE |
|----------|-------|
| D7061 | |

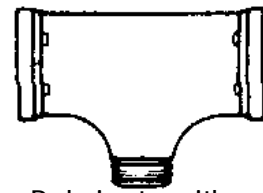

Reducing tee with
threaded branch

| FIG. NO. | PRICE |
|----------|-------|
| D7064 | |



Concentric reducer

| FIG. NO. | PRICE |
|----------|-------|
| D7072 | |



Reducer, threaded,
small end

| FIG. NO. | PRICE |
|----------|-------|
| D7076 | |



Eccentric reducer

| FIG. NO. | PRICE |
|----------|-------|
| D7073 | |

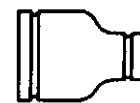

Steel swaged nipple

| FIG. NO. | PRICE |
|----------|-------|
| D7077 | |

GROOVED END FITTINGS

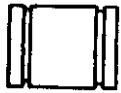

Adapter Nipple
GrxGr

| FIG. NO. | PRICE |
|----------|-------|
| D7080 | |

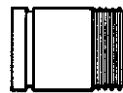

Adapter Nipple
GrxMPT

| FIG. NO. | PRICE |
|----------|-------|
| D7081 | |

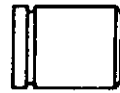

Adapter Nipple
GrxBEV

| FIG. NO. | PRICE |
|----------|-------|
| D7082 | |

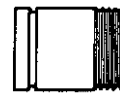

Di-Electric Nipple
(GrxMPT)

| FIG. NO. | PRICE |
|----------|-------|
| D7088 | |

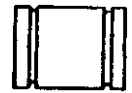

Di-Electric Nipple
(GRXGR)

| FIG. NO. | PRICE |
|----------|-------|
| D7089 | |



Hose Nipple

| FIG. NO. | PRICE |
|----------|-------|
| D7086 | |



Bullhead Tee

| FIG. NO. | PRICE |
|----------|-------|
| D7062 | |



Bull Plug

| FIG. NO. | PRICE |
|----------|-------|
| D7075 | |

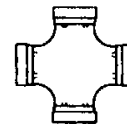

Cross

| FIG. NO. | PRICE |
|----------|-------|
| D7068 | |

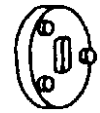

Cap

| FIG. NO. | PRICE |
|----------|-------|
| D7074 | |

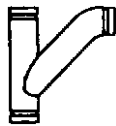

Tee Wye

| FIG. NO. | PRICE |
|----------|-------|
| D7066 | |

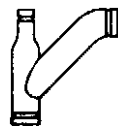

Reducing Tee

| FIG. NO. | PRICE |
|----------|-------|
| D7067 | |



Lateral

| FIG. NO. | PRICE |
|----------|-------|
| D7069 | |

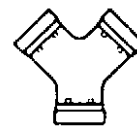

True Wye

| FIG. NO. | PRICE |
|----------|-------|
| D7071 | |

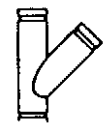

Reducing Lateral

| FIG. NO. | PRICE |
|----------|-------|
| D7070 | |



Standpipe Tee

| FIG. NO. | PRICE |
|----------|-------|
| D7065 | |



Grooved end check
valve

| FIG. NO. | PRICE |
|----------|-------|
| D7800 | |

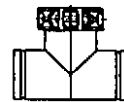

Grooved end strainer

| FIG. NO. | PRICE |
|----------|-------|
| D7260 | |

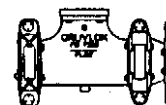

Gruvlok suction
diffuser

| FIG. NO. | PRICE |
|----------|-------|
| D7250 | |

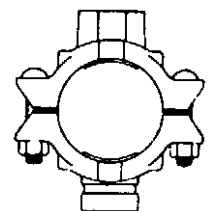

Clamp-T Cross

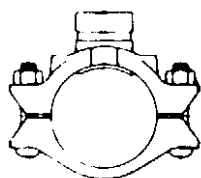

Grooved outlet mid
pipe outlet

| FIG. NO. | PRICE |
|----------|-------|
| D7046 | |

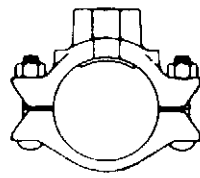

FPT outlet mid pipe
outlet

| FIG. NO. | PRICE |
|----------|-------|
| D7045 | |

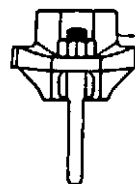

Clamp-T with U-bolt

| FIG. NO. | PRICE |
|----------|-------|
| D7044 | |

Thread X Thread

| FIG. NO. | PRICE |
|----------|-------|
| D7047 | |

Groove X Groove

| FIG. NO. | PRICE |
|----------|-------|
| D7048 | |

Groove X Thread

| FIG. NO. | PRICE |
|----------|-------|
| D7049 | |

FIRE HOSE, FITTINGS AND ACCESSORIES

300# SINGLE JACKET ALL POLYESTER FIRE HOSE

300 PSI PROOF PRESSURE
 150 PSI SERVICE TEST PRESSURE
 135 PSI WORKING PRESSURE



UNCOUPLED - per foot

| SIZE | FIG. NO. | PRICE |
|--------|----------|-------|
| 1 1/2" | 11344 | |
| 2" | 11348 | |
| 3" | 11352 | |
| 4" | 11353 | |



COUPLED - per 50' length

| SIZE | FIG. NO. | PRICE |
|--------|----------|-------|
| 1 1/2" | 11354 | |
| 2" | 11355 | |
| 3" | 11356 | |
| 4" | 11357 | |

FIRE HOSE NOZZLE

Brass
 Female with washers



| SIZE | FIG. NO. | PRICE |
|----------|----------|-------|
| 3/4X6 | 4781 | |
| 1X8 | 4793 | |
| 1 1/2X10 | 55282 | |

FOG NOZZLE

With rubber bumpers



| SIZE | FIG. NO. | PRICE |
|-----------|----------|-------|
| 1 1/2 IPT | 63888 | |
| 1 1/2 NST | 63889 | |

BUCKLEY STYLE FIRE HYDRANT ADAPTER/REDUCER

Cast brass with washer
 Pin lug

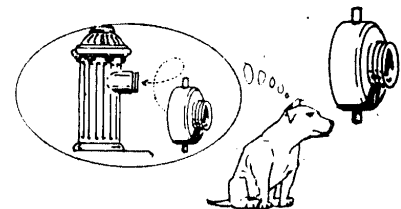

| SIZE | FIG. NO. | PRICE |
|-----------------|----------|-------|
| 2 1/2 Fem NST | 63892 | |
| 3/4 Garden Hose | 63893 | |
| 1 1/2 IPT | 63894 | |
| 1 1/2 NST | 63895 | |
| 2 IPT | 63896 | |

HYDRANT WRENCH

5 hole
 Cast Iron



| FIG. NO. | PRICE |
|----------|-------|
| 47909 | |

SPANNER WRENCH

For pin lug couplings
 Cast Iron



| SIZE | FIG. NO. | PRICE |
|-------|----------|-------|
| 1 1/2 | 4589 | |
| 2 | 4593 | |
| 3 | 4596 | |
| 4 | 4598 | |

**NOTE: MUST SPECIFY
 HYDRANT THREAD SIZE WHEN
 ORDERING SIZES
 FROM 1 1/2 TO 4"
 NST AVAILABLE FOR HYDRANT
 ADAPTER**



PLUMBING



PLUMBING



T&S BRASS FAUCETS AND FITTINGS

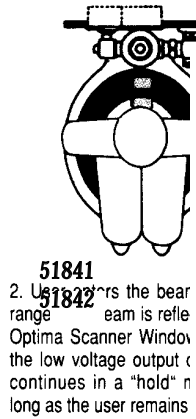
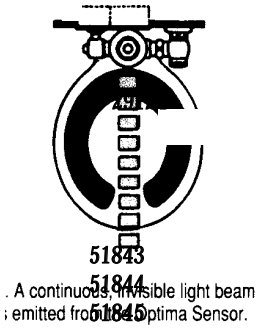

28922

51848
15629
51849

51850
51851
51852

51853

51854

51855
51856
51857

51858
51859

29112
29113
29114

| FIG. NO. | MODEL NO. | DESCRIPTION | PRICE |
|----------|-----------|---|-------|
| 29124 | B-252 | Double pantry faucet with 12" double joint swing nozzle | |
| 51841 | B-305 | Single pantry faucet with 13 1/4" high rigid gooseneck spout | |
| 51842 | B-306 | Single pantry faucet with 12 1/4" high swivel gooseneck spout | |
| 51843 | B-205 | Single pantry faucet with 18" swing nozzle | |
| 51844 | B-206 | Single pantry faucet with 12" swing nozzle | |
| 51845 | B-207 | Single pantry faucet with 6" swing nozzle | |
| 29125 | B-255 | Single pantry faucet with 18" double joint swing nozzle | |
| 29126 | B-256 | single pantry faucet with 15" double joint swing nozzle | |
| 29127 | B-257 | Single pantry faucet with 12" double joint swing nozzle | |
| 28922 | B-208 | Single pantry faucet with 6" cast nozzle | |
| 51846 | B-320 | Deck-mount faucet with 12 3/4" high rigid gooseneck spout | |
| 15627 | B-321 | Deck-mount faucet with 12 3/4" high swivel gooseneck spout | |
| 51847 | B-245 | Deck mixing faucet with 18" double-joint swing nozzle | |
| 29120 | B-246 | Deck mixing faucet with 15" double joint swing nozzle | |
| 29121 | B-247 | Deck mixing faucet with 12" double joint swing nozzle | |
| 51848 | B-220 | Deck mixing faucet with 18" swing nozzle | |
| 15629 | B-221 | Deck mixing faucet with 12" swing nozzle | |
| 51849 | B-222 | Deck mixing faucet with 6" swing nozzle | |
| 51850 | B-230 | Sink mixing faucet with 18" swing nozzle | |
| 51851 | B-231 | Sink mixing faucet with 12" swing nozzle | |
| 51852 | B-232 | Sink mixing faucet with 6" swing nozzle | |
| 51853 | B-233-1 | Sink mixing faucet with 6" swing nozzle and soap dish | |
| 51854 | B-234EE | Sink mixing faucet with 6" cast nozzle | |
| 51855 | B-265 | Combo sink faucet with 18" double joint swing nozzle | |
| 51856 | B-266 | Combo sink faucet with 15" double-joint swing nozzle | |
| 51857 | B-267 | Combo sink faucet with 12" double-joint swing nozzle | |
| 51858 | B-330 | Combo sink faucet with 10 1/4" high rigid gooseneck spout | |
| 51859 | B-331 | Combo sink faucet with 9 1/4" high swivel gooseneck spout | |
| 29112 | B-235 | Combo sink faucet with 18" swing nozzle | |
| 29113 | B-236 | Combo sink faucet with 12" swing nozzle | |
| 29114 | B-237 | Combo sink faucet with 6" swing nozzle | |

T&S BRASS FAUCETS AND FITTINGS

**WE CAN MIX & MATCH
ALL FAUCETS WITH ALL
SPOUTS!**

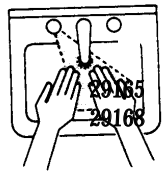
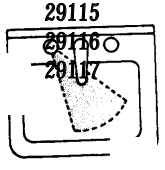

1. A continuous, invisible light beam is emitted from the Optima Sensor.

29167
29166

2. The faucet is activated by placing hands within the range of the sensor. Immediately, tempered water flow for as long as the user's hand remain within range.

60573
29161

29128
29129
29130

51860
51861
51862

28928

51863
51864
51865
51866

DON'T FORGET SUPPLY NIPPLES!

15639

29164

29365

29375

29376

29378

29399

32105



29331

29087

| FIG. NO. | MODEL NO. | DESCRIPTION | PRICE |
|----------|-----------|--|-------|
| 29115 | B-240 | Combo sink faucet 18" swing nozzle with integral stops | |
| 29116 | B-241 | Combo sink faucet 12" swing nozzle with integral stops | |
| 29117 | B-242 | Combo sink faucet 6" swing nozzle with integral stops | |
| 29165 | B-340 | Combo sink faucet with 10 1/4" high rigid gooseneck spout | |
| 29166 | B-341 | Combo sink faucet with 9 1/4" high swivel goose neck spout with integral stops | |
| 29167 | B-342 | Combo sink faucet with 10 1/4" high rigid gooseneck spout with integral stops | |
| 29168 | B-343 | Combo sink faucet with 9 1/4" high swivel gooseneck spout | |
| 60573 | B-310 | Single sink faucet with 10 3/4" high rigid goose-neck spout | |
| 29161 | B-312 | Single sink faucet with 9 3/4" high swivel goose-neck spout | |
| 29128 | B-260 | Single sink faucet with 18" long double-joint swing nozzle | |
| 29129 | B-261 | Single sink faucet with 15" long double-joint swing nozzle | |
| 29130 | B-262 | Single sink faucet with 12" long double-joint swing nozzle | |
| 28928 | B-216 | Single sink faucet with 6" cast nozzle | |
| 51860 | B-210 | Single sink faucet with 18" swing nozzle | |
| 51861 | B-211 | Single sink faucet 12" swing nozzle | |
| 51862 | B-212 | Single sink faucet 6" swing nozzle | |
| 51863 | B-225 | Deck mixing faucet with 12" swing nozzle | |
| 51864 | B-226 | Deck mixing faucet with 10" swing nozzle | |
| 51865 | B-227 | Deck mixing faucet with 8" swing nozzle | |
| 51866 | B-228 | Deck mixing faucet with 6" swing nozzle | |
| 15639 | B-325 | Deck mixing faucet with 11 3/4" swivel goose-neck spout | |
| 29164 | B-326 | Deck mixing faucet with 12" rigid gooseneck spout | |
| 29365 | B-702 | Single sink faucet with 1/2" IPS female inlets | |
| 29375 | B-710 | Single basin faucet | |
| 29376 | B-711 | Single basin faucet with self-closing valve | |
| 29378 | B-712 | Single basin faucet with self-closing valve, push button. | |
| 29399 | B-807 | Slow self-closing mixing faucet | |
| 29087 | B665BSTR | Service sink faucet with Vacuum breaker and brace | |
| 32105 | B-669RC | Service sink faucet with vacuum breaker | |
| 29331 | B-667RC | Service sink faucet with vacuum breaker and brace | |

T&S BRASS FAUCETS AND FITTINGS

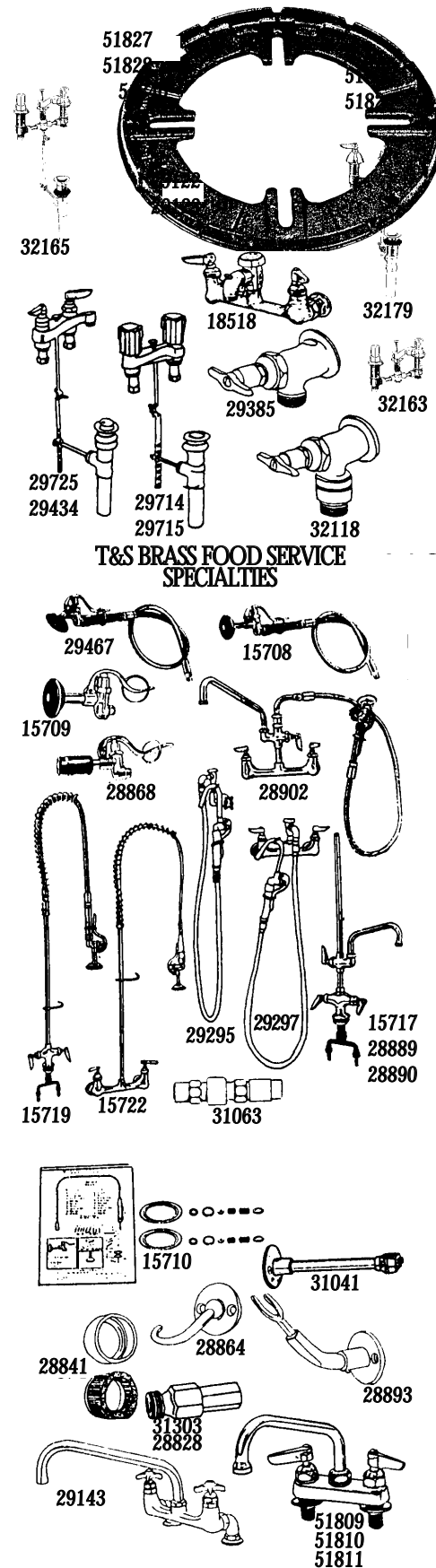

| FIG. NO. | MODEL NO. | DESCRIPTION | PRICE |
|----------|-----------|--|-------|
| 51825 | B-300 | Dble pantry faucet w/ 13" high rigid gooseneck spout | |
| 51826 | B-301 | Dble pantry faucet w/ 12" high swivel nozzle | |
| 51827 | B-200 | Double pantry faucet with 18" swing nozzle | |
| 51828 | B-201 | Double pantry faucet with 12" swing nozzle | |
| 51840 | B-202 | Double pantry faucet with 6" swing nozzle | |
| 29122 | B-250 | Double pantry faucet with 18" double-joint swing nozzle | |
| 29123 | B-251 | Double pantry faucet with 15" double-joint swing nozzle | |
| 32165 | B-2825 | Lav faucet slow self-close w/ pop-up 8" center | |
| 32163 | B-2823 | Lav faucet slow self-close L/ pop-up 8" center | |
| 32179 | B-2882 | Lav faucet with pop-up, 8" center | |
| 18518 | B674RC | Service sink faucet with vacuum breaker | |
| 29385 | B-730 | Sill faucet with 1/2" female inlet; 3/4" hose outlet and loose key | |
| 32118 | B-736 | Sill faucet with 1/2" female inlet; 3/4" hose outlet, vacuum breaker and loose key | |
| 29434 | B-870 | Centerset lav faucet with pop-up drain | |
| 29725 | B-871 | Centerset lav faucet less pop-up drain | |
| 29714 | B-1870 | Centerset lav faucet with pop-up drain | |
| 29715 | B-1871 | Centerset lav faucet less pop-up drain | |
| 15708 | B-100 | Pre-rinse spray with flex stainless steel hose | |
| 29467 | B-950 | Flex stainless steel hose w/ self closing spray valve | |
| 15709 | B-107 | Pre-rinse spray | |
| 28868 | B-107C | Pre-rinse spray w/ fan jet knife action spray vlv | |
| 15719 | B-113 | Pre-rinse unit with deck mount valve | |
| 15722 | B-133 | Pre-rinse unit with wall mount valve | |
| 28902 | B-175 | Pre-rinse unit with wall mount valve & nozzle | |
| 29295 | B-605 | Pot and kettle filler, wall mount w/ single temp control | |
| 29297 | B-610 | Pot & Kettle Filler, wall mount, 8" centers | |
| 15717 | B155ADF | Add-on faucet for use w/ pre-rinse units (6" nozzle) | |
| 28889 | B156ADF | Add-on faucet for use w/ pre-rinse units (12" nozzle) | |
| 28890 | B157ADF | Add-on faucet for use w/ pre-rinse units (18" nozzle) | |
| 15710 | B-10K | Repair kit for B-07 spray valve (FIG NO 15710) | |
| 31041 | B-109-1 | Wall bracket | |
| 28841 | BR-10 | Brush Attachment | |
| 28864 | B-104D | Dummy wall hook | |
| 28893 | B-166 | Dummy wall hook | |
| 31303 | 53-A | 3/8" IPS adapter for pre-rinse units | |
| 28828 | 55-A | 1/2" IPS adapter for pre-rinse units | |
| 29143 | B-290 | Deck faucet with 12" swing nozzle | |
| 51809 | B-1110 | Workboard faucet, 4" CC w/ 6" swing nozzle | |
| 51810 | B-1111 | Workboard faucet, 4" CC w/ 8" swing nozzle | |
| 51811 | B-1112 | Workboard faucet, 4" CC w/ 10" swing nozzle | |
| 31063 | B0044V9 | 44" Hose w/ vacuum breaker | |

For additional information call: 610-275-4453 or Fax: 610-279-6299
 Prices are a guide only. Please call for current prices.

T&S BRASS FOOD SERVICE SPECIALTIES

**DUFF HAS THE LARGEST
T&S BRASS STOCK IN
THE REGION!**

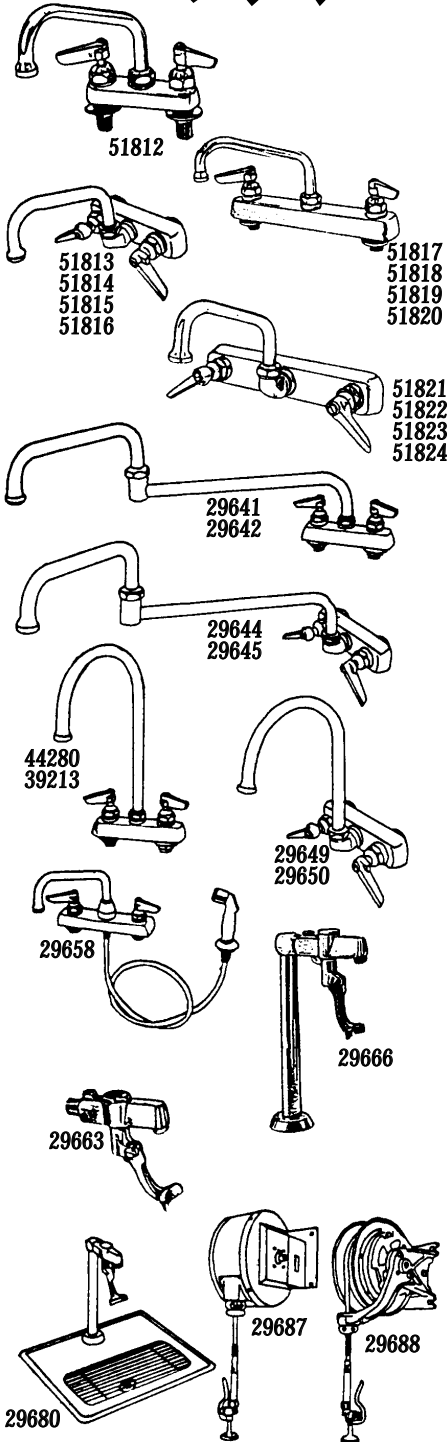

| FIG. NO. | MODEL NO. | DESCRIPTION | PRICE |
|----------|-----------|--|-------|
| 51812 | B-1113 | Workboard faucet, 4" CC with 12" swing nozzle | |
| 51817 | B-1120 | Workboard faucet, 8" CC w/ 6" swing nozzle | |
| 51818 | B-1121 | Workboard faucet, 8" CC w/ 8" swing nozzle | |
| 51819 | B-1122 | Workboard faucet, 8" CC with 10" swing nozzle | |
| 51820 | B-1123 | Workboard faucet, 8" CC with 12" swing nozzle | |
| 51813 | B-1115 | Workboard wall mount faucet, 4" CC with 6" swing nozzle | |
| 51814 | B-1116 | Workboard wall mount faucet, 4" CC with 8" swing nozzle | |
| 51815 | B-1117 | Workboard wall mount faucet, 4" CC with 10" swing nozzle | |
| 51816 | B-1118 | Workboard wall mount faucet, 4" CC with 12" swing nozzle | |
| 51821 | B-1125 | Workboard wall mount faucet, 8" CC with 6" swing nozzle | |
| 51822 | B-1126 | Workboard wall mount faucet, 8" CC with 8" swing nozzle | |
| 51823 | B-1127 | Workboard wall mount faucet, 8" CC with 10" swing nozzle | |
| 51824 | B-1128 | Workboard wall mount faucet, 8" CC with 12" swing nozzle | |
| 29641 | B-1131 | Workboard deck mount faucet, 4" CC with 18" Double-joint swing nozzle | |
| 29642 | B-1132 | Workboard deck mount faucet, 8" CC with 18" Double-joint swing nozzle | |
| 29644 | B-1136 | Workboard wall mount faucet, 4" CC with 18" Double-joint swing nozzle | |
| 29645 | B-1137 | Workboard wall mount faucet, 8" CC with 18" double-joint swing nozzle | |
| 44280 | B-1141 | Workboard deck mount faucet, 4" CC with 9 1/4" high swivel gooseneck spout | |
| 39213 | B-1142 | Workboard deck mount faucet, 8" CC with 9 1/4" high swivel gooseneck spout | |
| 29649 | B-1146 | Workboard wall mount faucet, 4" CC with 9" high swivel gooseneck spout | |
| 29650 | B-1147 | Workboard wall mount faucet, 8" CC with 9" high swivel gooseneck spout | |
| 29658 | B-1172 | sink faucet with auto diverter vinyl hose, 8" CC and 8" swing nozzle | |
| 29666 | B-1210 | Pedestal type push back glass filler | |
| 29663 | B-1205 | Push back glass filler, wall mount | |
| 29680 | B-1230 | Water station system complete | |
| 29687 | B-1400 | Reel clean enclosed model with 35" hose | |
| 29688 | B-1403 | Reel clean open model with 35" hose | |

**REMEMBER, WE CAN SUPPLY ALL TYPES OF
HANDLES AND SPOUTS ON ALL TYPES OF FAUCETS!**

T&S BRASS HOSPITAL AND MEDICAL FITTINGS

**DON'T FORGET
SUPPLY
NIPPLES!**

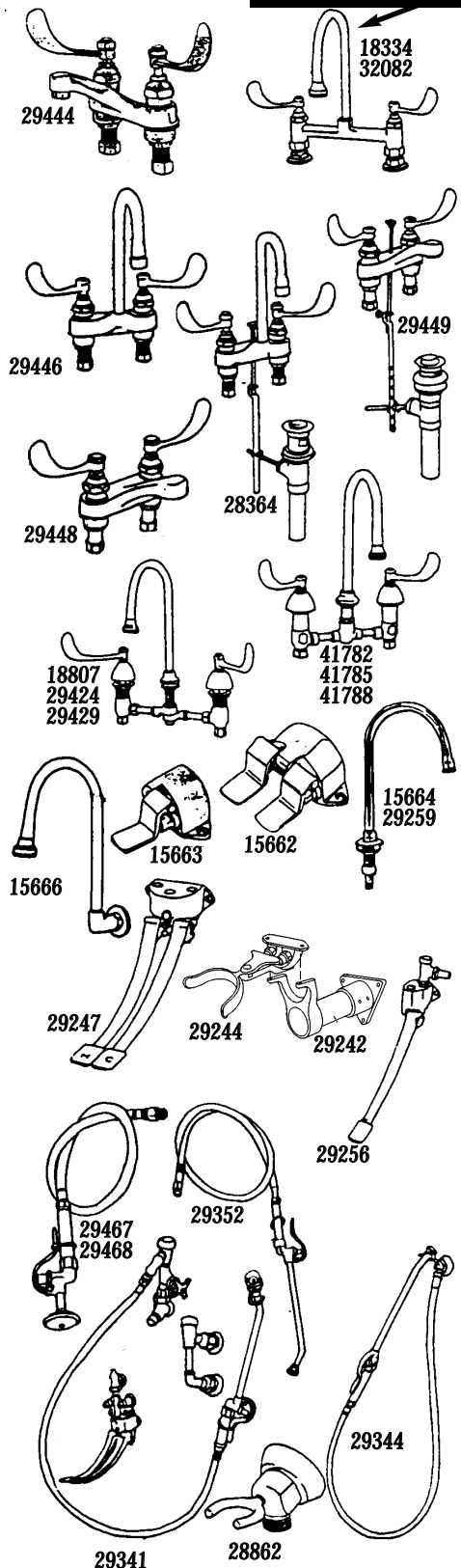

| FIG. NO. | MODEL NO. | DESCRIPTION | PRICE |
|----------|-----------|--|-------|
| 18334 | B-322-4 | Surgical sink faucet, 8" CC w/ 9" rigid goose-neck spout w/ rosespray | |
| 32082 | B-323-4 | Surgical sink faucet, 8" CC with 9" rigid goose-neck spout with stream regulator | |
| 29444 | B-890 | Medical lavatory faucet, 4" CC with 4" wrist blade handles | |
| 29446 | B-892 | Medical lavatory faucet, 4" CC with 8 3/4" gooseneck spout & wrist blade handles | |
| 28364 | B-893 | Medical lavatory faucet, 4" CC with 4" wrist blade handles and pop-up drain | |
| 29449 | B-895 | Medical lavatory faucet, 4" CC with 4" wrist blade handles and pop-up drain | |
| 29448 | B-894 | Medical lavatory faucet, 4" CC with 4" wrist blade handles less pop-up drain | |
| 41782 | B-2865-4 | Medical lavatory faucet 8" CC with 9 3/4" high rigid gooseneck spout | |
| 41785 | B-2866-4 | Medical lavatory faucet 8" CC with 9 3/4" high swivel gooseneck spout | |
| 41788 | B-2867-4 | Medical lavatory faucet 8" CC with 9 3/4" high swivel gooseneck spout with aerator | |
| 18807 | B-865-4 | Medical lavatory faucet 8" CC with 9 3/4" high rigid gooseneck spout | |
| 29424 | B-866-4 | Medical lavatory faucet 8" CC with 9 3/4" high swivel gooseneck spout | |
| 29429 | B-867-4 | Medical lavatory faucet 8" CC with 9 3/4" high swivel gooseneck spout with aerator | |
| 15662 | B-502 | Double pedal valve, floor mounted | |
| 15663 | B-507 | Single pedal valve, floor mounted | |
| 15664 | B-520 | Rigid 10" high gooseneck spout, deck mount | |
| 29259 | B-521 | Rigid 10" high gooseneck spout, deck mount with aerator | |
| 15666 | B-535 | Rigid 9 3/4" high gooseneck spout, wall mounted | |
| 29247 | B-504 | Double pedal valve, wall mount | |
| 29244 | B-475 | Knee action valve | |
| 29242 | B-473 | Wall support for knee action valve | |
| 29256 | B-508LKS | Single pedal valve, wall mount with straight stops | |
| 29352 | B-690 | Bedpan washer with self-closing spray valve and rubber hose | |
| 29467 | B-950 | Bedpan washer with self-closing spray valve and stainless steel hose | |
| 29468 | B-955 | Bedpan washer with self-closing valve and rubber hose | |
| 28862 | B-104 | Wall hook and flanged water supply elbow | |
| 29341 | B-675 | Bedpan washer system with pedal valves and vacuum breaker | |
| 29344 | B-678 | Bedpan washer | |

For additional information call: 610-275-4453 or Fax: 610-279-6299
 Prices are a guide only. Please call for current prices.

T&S BRASS LABORATORY AND SERVICE FITTINGS

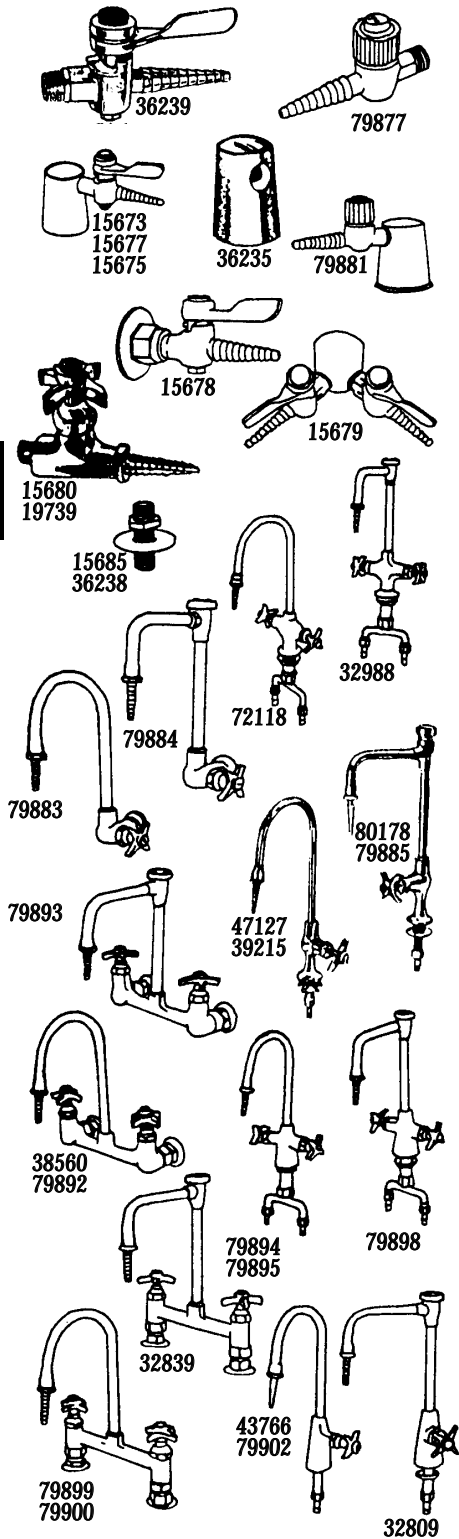

**ALL SPOUTS AVAILABLE
RIGID OR SWIVEL**

| FIG. NO. | MODEL NO. | DESCRIPTION | PRICE |
|----------|-----------|---|-------|
| 36239 | BL4000-1 | Ground key hose cock with 3/8" IPS male inlet | |
| 79877 | BL4010-1 | Needle valve w/serrated tip w/3/8" IPS male inlet | |
| 36235 | BL4100-1 | Lab turret 3/8" IPS female inlet and 3/8" side outlet | |
| 15673 | BL4200-1 | Turret with hose cock, 3/8" IPS Female inlet | |
| 15675 | BL4200-2 | Turret w/ hose cock, 3/8" IPS Female inlet & two 180 degree outlets | |
| 15677 | BL4200-4 | Turret w/ hose cock, 3/8" IPS Female inlet & four outlets | |
| 79881 | BL4210-1 | Turret with needle valve, 3/8" IPS Female inlet | |
| 15678 | BL4250-1 | Panel flange w/ hose cock, 3/8"IPS Female inlets | |
| 15679 | BL4250-2 | Double panel flange with two hose cocks, 3/8" IPS Female inlets | |
| 15680 | BL4500-1 | Straight stop with 3/8" Male IPS inlet | |
| 19739 | BL4500-2 | Straight stop with 3/8" Male IPS inlet with Eterna construction for water | |
| 15685 | BL5500-7 | Supply nipple & lockout for panel mountings, 3/8" IPS | |
| 36238 | BL550010 | Supply nipple & lockout for deck mountings, 3/8" IPS | |
| 72118 | BL5700-1 | Double ledge faucet w/ 13" high gooseneck spout | |
| 32988 | BL5700-8 | Double ledge faucet with 13" vacuum breaker, high gooseneck spout | |
| 79883 | BL2710-1 | Single sink fct w/ 10 3/4" rigid gooseneck spout | |
| 79884 | BL5710-3 | Single sink fct w/ 11 1/2" swivel gooseneck spout | |
| 79885 | BL5710-7 | Single sink faucet w/ 10 1/4" vacuum breaker gooseneck spout | |
| 47127 | BL5705-1 | Single ledge faucet with 13 1/4" rigid gooseneck spout | |
| 39215 | BL5705-2 | Single ledge faucet w/ 13 3/4" swivel gooseneck spout | |
| 80178 | BL5705-8 | Single ledge faucet with 12 3/4" vacuum breaker gooseneck spout | |
| 79892 | BL5725-1 | Sink mixing faucet w/ 11" rigid gooseneck spout | |
| 38560 | BL5725-2 | Sink mixing faucet w/ 11" swivel gooseneck spout | |
| 79893 | BL5725-8 | Sink mixing faucet with 11" vacuum breaker high gooseneck spout | |
| 79894 | BL5704-1 | Double ledge faucet w/ 13" rigid gooseneck faucet | |
| 79895 | BL5704-2 | Double ledge faucet w/ 13" swivel gooseneck faucet | |
| 79898 | BL5704-8 | Double ledge faucet with 13" vacuum breaker gooseneck faucet | |
| 79899 | BL5715-1 | Ledge mixing faucet w/ 13" rigid gooseneck spout | |
| 79900 | BL5715-2 | Ledge mixing faucet w/ 13" swivel gooseneck spout | |
| 32839 | BL5715-8 | Ledge mixing faucet with 13" vacuum breaker gooseneck spout | |
| 43766 | BL5709-1 | Single sledge faucet w/ 13 1/4" rigid gooseneck spout | |
| 79902 | BL5709-2 | Single ledge faucet w/ 13 3/4" swivel gooseneck spout | |
| 32809 | BL5709-8 | Single ledge faucet with 12 3/4" vacuum breaker gooseneck spout | |

T&S BRASS SPOUTS

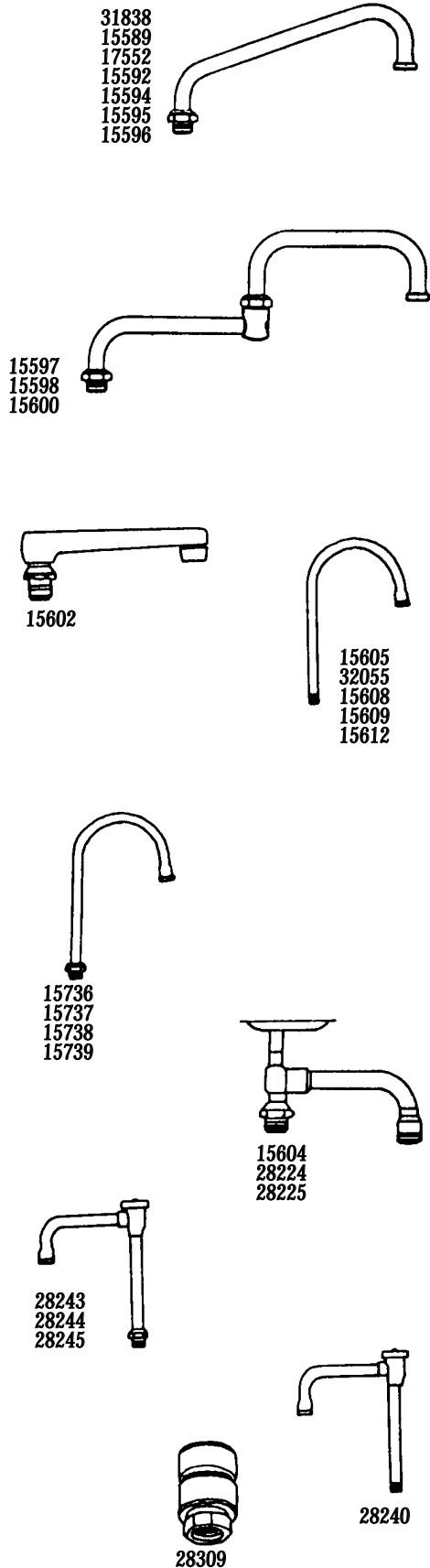

| FIG. NO. | MODEL NO. | DESCRIPTION | PRICE |
|----------|-----------|---|-------|
| 31838 | 59X | 6" swing nozzle | |
| 15589 | 60X | 8" swing nozzle | |
| 17552 | 61X | 10" swing nozzle | |
| 15592 | 62X | 12" swing nozzle | |
| 15594 | 63X | 14" swing nozzle | |
| 15595 | 64X | 16" swing nozzle | |
| 15596 | 65X | 18" swing nozzle | |
| 15597 | 66X | 6" double joint swing spout | |
| 15598 | 67X | 9" double joint swing spout | |
| 15600 | 68X | 18" double joint swing nozzle | |
| 15602 | CS-6 | 6" cast swing nozzle | |
| 15605 | 119X | 2 3/4" center to center by 8" high rigid goose-neck spout | |
| 32055 | 120X | 5 3/4" center to center by 9 1/2" high rigid gooseneck spout | |
| 15608 | 122X | 5 3/4" center to center by 11 1/2" high rigid gooseneck spout | |
| 15609 | 123X | 5 3/4" center to center by 12 1/2" high rigid gooseneck spout | |
| 15612 | 129X | 5 3/4" center to center by 10 3/4" high rigid gooseneck spout | |
| 15736 | 131X | 2 3/4" center to center by 8" high rigid goose-neck spout | |
| 15737 | 132X | 2 3/4" center to center by 8 3/4" high rigid gooseneck spout | |
| 15738 | 133X | 5 3/4" center to center by 8 3/4" high rigid gooseneck spout | |
| 15739 | 135X | 8 3/4" center to center by 11 3/4" high rigid gooseneck spout | |
| 15604 | 160X | 6" soap dish swing nozzle | |
| 28224 | 161X | 8" soap dish swing nozzle | |
| 28225 | 162X | 12" soap dish swing nozzle | |
| 28243 | B-406-2 | Swivel vacuum breaker gooseneck spout 5 3/4" reach x 9 1/2" high | |
| 28244 | B-406-3 | Swivel vacuum breaker gooseneck spout 8 3/4" reach x 9 1/2" high | |
| 28245 | B-406-4 | Swivel vacuum breaker gooseneck spout 11 3/4" reach x 9 1/2" high | |
| 28240 | B-405-2 | Vacuum breaker gooseneck 5 3/4" reach X 9 1/4" high | |
| 28309 | B-970FE | Atmospheric back flow preventer 3/8" IPS Female inlet | |



**ALL SPOUTS ARE
AVAILABLE ON ALL
FAUCETS!
PLEASE CALL FOR
ASSISTANCE!**

T&S BRASS CONVERSION ADAPTERS

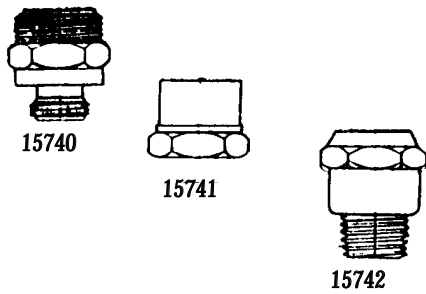

| FIG. NO. | MODEL NO. | DESCRIPTION | PRICE |
|----------|-----------|-------------------------|-------|
| 15740 | B-412 | Rigid to swivel adapter | |
| 15741 | B-413 | Swivel to rigid adapter | |
| 15742 | B-414 | Gooseneck coupling | |

T&S BRASS HANDLES (SOLD EACH)

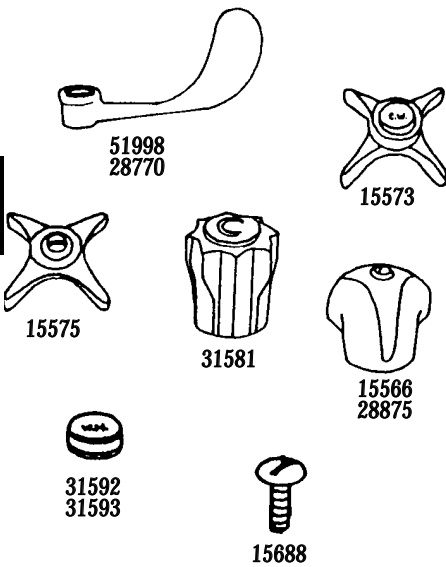

| | | |
|-------|---------|-------------------------|
| 51998 | B-WH-4 | Wrist action handle 4" |
| 28770 | B-WH-6 | Wrist action handle 6" |
| 15573 | 175F | 4-arm faucet handle |
| 15575 | 5L | 4-arm lab handle |
| 31581 | 76F | Alpine handle |
| 15566 | 180F | Lavatory handle, cold |
| 28775 | 181F | Lavatory handle, hot |
| 31592 | 209L-CW | Cold water index button |
| 31593 | 209L-H | Hot water index button |
| 15688 | 25F | Handle screw |

HANDLES CAN BE INTERCHANGED! PLEASE CALL FOR ASSISTANCE.

T&S BRASS AERATORS

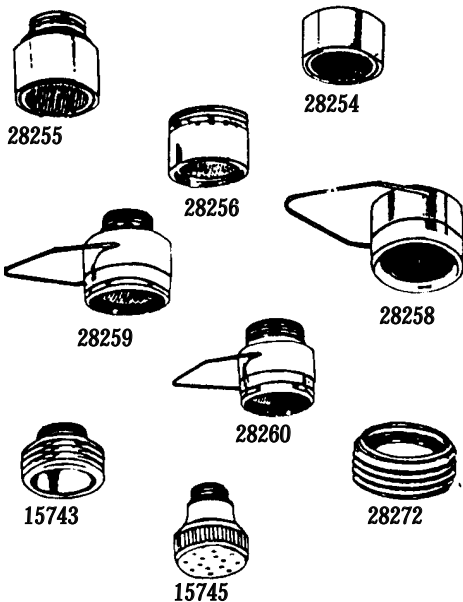

| | | |
|-------|---------|--|
| 28255 | B-199-2 | Non-splash aerator, 55/64" Female aerator threads |
| 28256 | B-199-3 | Non-splash aerator, 3/8" IPS Male threads for goosenecks |
| 28258 | B-199-6 | Non-splash aerator, 13/16" Male threads for lav spouts |
| 28259 | B-199-7 | Vandal proof non-splash aerator, 55/64" Female aerator threads |
| 28260 | B-199-8 | Vandal proof non-splash aerator, 3/8" Male threads |
| 28272 | B-GFE | Vandal proof non-splash aerator 13/16" male threads |
| 15743 | B-GH | Garden hose outlet, 55/64 Female aerator threads |
| 15745 | B-103 | Garden hose outlet 3/8" IPS Male threads |
| | | Rosespray |

T&S BRASS MISCELLANEOUS PARTS

**CAN BE CUSTOM MADE
TO ANY LENGTH!**

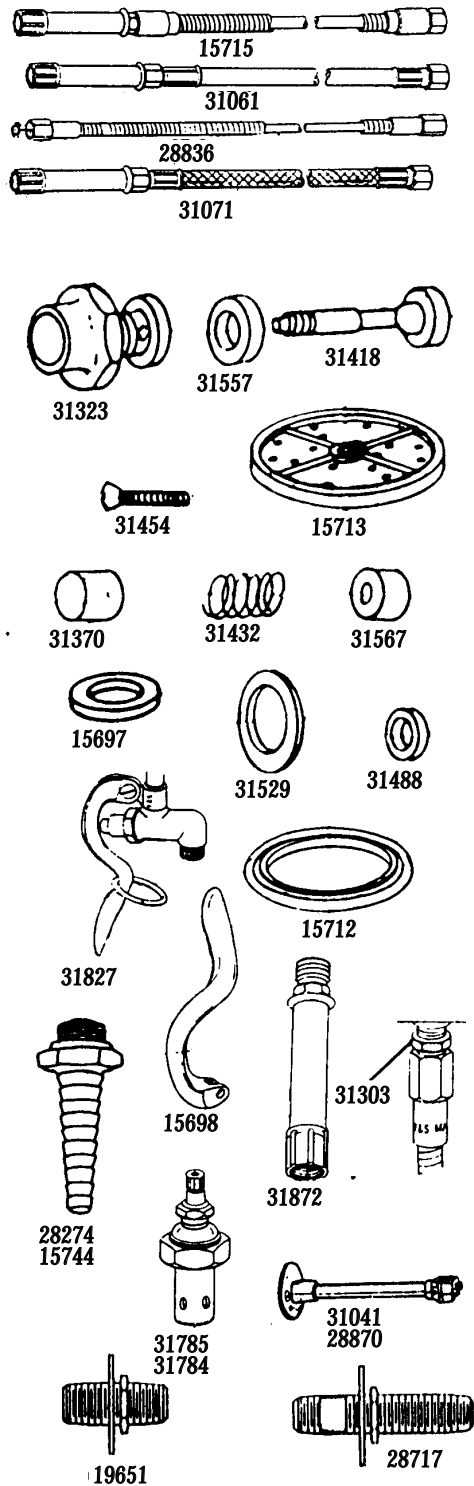

| FIG. NO. | MODEL NO. | DESCRIPTION | PRICE |
|----------|-----------|--|-------|
| 15715 | B-44H | Flexible stainless steel hose | |
| 31061 | B-44R | Reinforced rubber hose | |
| 28836 | B-68H | Stainless steel hose for bedpan washer | |
| 31071 | B-68R | Reinforced rubber hose | |
| 31323 | 608-25 | Bonnet for spray valve | |
| 31557 | 1084-45 | Seat washer for spray valve | |
| 31418 | 842-20 | Stem for pre-rinse unit | |
| 15713 | 1121-45 | Spray face for pre-rinse unit | |
| 31454 | 913-45 | Screw for spray face on b-107 pre-rinse unit | |
| 31370 | 753-25 | Push button for spray valve | |
| 31432 | 885-45 | Bonnet spring | |
| 31567 | 1097-45 | Packing for spray valve | |
| 15697 | 1015-45 | Washers for bedpan washer | |
| 31529 | 1040-45 | Binding washer for spray valve | |
| 31488 | 974-45 | Washer for pre-rinse unit | |
| 31827 | 2865-40 | Spray valve for pre-rinse unit | |
| 15712 | 7861-45 | Rubber ring for B107 | |
| 15698 | 1120-45 | Squeeze down handle for pre-rinse unit | |
| 31872 | 2987-40 | Plastic handle for pre-rinse unit | |
| 31303 | 545-25 | Hose adapter for work board faucets | |
| 28274 | B-198F | Low splash serrated tip | |
| 15744 | B-198 | Serrated tip | |
| 31785 | 2714-40 | Hot cartridges | |
| 31784 | 2713-40 | Cold cartridges | |
| 31041 | B-109-1 | Wall bracket 6" | |
| 28870 | B-109-2 | Wall bracket 9" | |
| 19651 | B-425 | Supply nipple 1/2" x 2" | |
| 28717 | B-426 | Supply nipple 1/2" x 3 3/8" | |

T&S BRASS MISCELLANEOUS PARTS PARTS

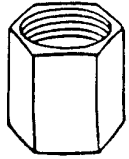

Spray hose adapter - Permits T&S spray hoses to be adapted to Fisher spray hoses.

| FIG. NO. | PRICE |
|----------|-------|
| 61267 | |

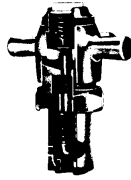

T&S self-closing stem assemblies. Fits all "ETERNA" models.

| FIG. NO. | PRICE |
|------------|-------|
| Cold 31841 | |
| Hot 31840 | |



Replacement glass filler arms.

| FIG. NO. | PRICE |
|----------|-------|
| 31584 | |

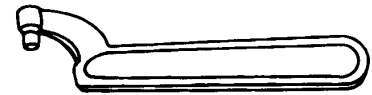

T&S Spanner Wrench.

| FIG. NO. | PRICE |
|----------|-------|
| 45033 | |

 T&S Index Button, Cold Water. Blue button marked C.W. for wrist action and cross handles. Button snaps in and is vandal resistant.

| FIG. NO. | PRICE |
|------------|-------|
| cold 28783 | |
| hot 28784 | |

 T&S Index Button, Cold Water for wrist action and cross handles. Red button marked H.W. (hot water). Green button Marked C.W. (cold water) for use in laboratories. Button snaps in and is vandal resistant. Specify service required.

| FIG. NO. | PRICE |
|------------------|-------|
| Hot Water 31593 | |
| Cold Water 31592 | |

 T&S Service Index. Blue service index for cold water. Fits T&S lever and Lavatory handles.

| FIG. NO. | PRICE |
|----------|-------|
| 28781 | |

 T&S Service Index. Same as 28781 but red for hot water service.

| FIG. NO. | PRICE |
|----------|-------|
| 28782 | |

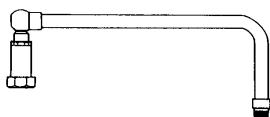

T&S swivel arm assembly. 12" length. For use on Fig No's 15720, 28875, 28879, 28880, 28882, 28883, 28885, 28886, 28898 and 28899

| FIG. NO. | PRICE |
|----------|-------|
| 31845 | |

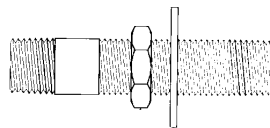

T&S faucet inlet nipple and locknut. converts faucets from female to male inlets. Brass.

| SIZE | FIG. NO. | PRICE |
|-------------|----------|-------|
| 1/2 X 2 | 19651 | |
| 1/2 X 3 3/8 | 28717 | |
| 3/4 X 2 1/2 | 28718 | |
| 2/8 X 2 1/8 | 28719 | |
| 3/8 X 3 3/8 | 28721 | |

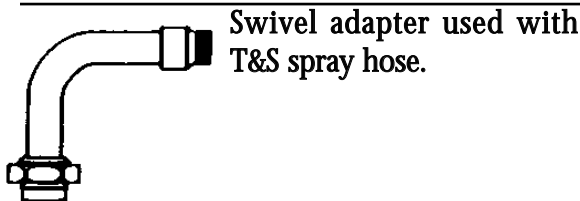

Swivel adapter used with T&S spray hose.

| FIG. NO. | PRICE |
|----------|-------|
| 31824 | |



T&S 238A Cartridge. Specify Hot, Cold or blank.

HANDLES

| FIG. NO. | PRICE |
|----------------|-------|
| #15 COLD 31841 | |
| #15 HOT 31840 | |
| BLANK 31835 | |

T&S FOOT AND KNEE VALVE PARTS.

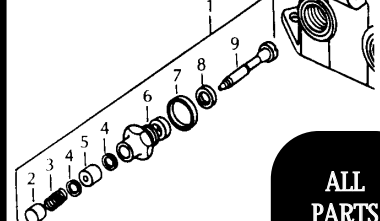

- 1 Bonnet Assembly
- 2 Push Button
- 3 Spring
- 4 bonnet washer
- 5 Packing
- 6 Bonnet Body
- 7 Binding washer
- 8 Seat washer
- 9 Stem

ALL PARTS AVAILABLE IN BULK!

COMPLETE UNIT

| DESCRIPTION | FIG. NO. | PRICE |
|------------------------------|----------|-------|
| (1) Complete Bonnet Assembly | | |
| | 15699 | |

T & S BRASS

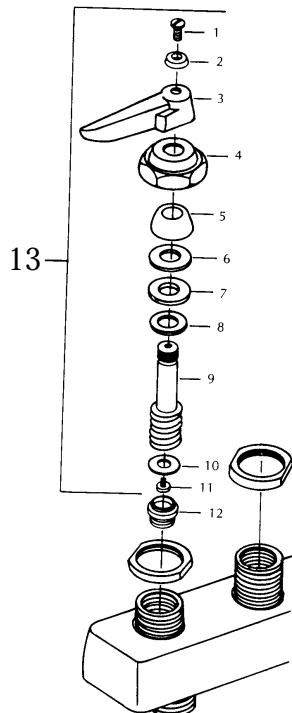

ALL PARTS AVAILABLE IN BULK!

T&S Faucet Parts for 1100 series faucet stem parts.

- 1 Screw
- 2 Cold index button
- 2 Hot index button
- 3 Cold handle
- 3 Hot handle
- 4 Bonnet
- 5 Packing
- 6 Stainless steel washer
- 7 Rubber washer
- 8 Brass washer
- 9 cold stem
- 9 Hot stem
- 10 Seat washer
- 11 Seat washer screw
- 12 Removable seat

C O M P L E T E U N I T

| DESCRIPTION | FIG. NO. | PRICE |
|-------------------------|----------|-------|
| (13) Cold stem assembly | 31780 | |
| (13) Hot stem assembly | 31781 | |

ETERNA STEM PARTS

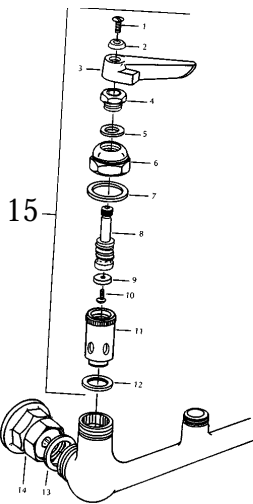

- 1 Screw
- 2 cold index button
- 2 Hot index button
- 3 cold handle
- 3 Hot handle
- 4 packing nut
- 5 Packing
- 6 Bonnet
- 7 Bonnet gasket
- 8 Cold stem
- 8 Hot stem
- 9 Seat washer
- 10 Seat washer screw
- 11 Cold insert
- 11 Hot insert
- 12 Seat gasket
- 13 Washer
- 14 Coupling flange

ALL PARTS AVAILABLE IN BULK!

| DESCRIPTION | FIG. NO. | PRICE |
|---------------------------|----------|-------|
| (15) Eterna Cold stem ass | 31784 | |
| (15) Eterna Hot stem ass | 31785 | |

For additional information call: 610-275-4453 or Fax: 610-279-6299
Please call for current prices.

PRE-RINSE PARTS AND ACCESSORIES

- 1 Spring
- 2 Spring Body
- 3 18" Riser tube
- 3 24" Riser tube
- 3 32" Riser tube
- 4 Finger hook and screw
- 5 Deck mount base faucet
- 6 Washer
- 7 Spreader assembly
- 8 Wall mount base faucet
- 9 Tailpiece
- 10 Tailpiece nut

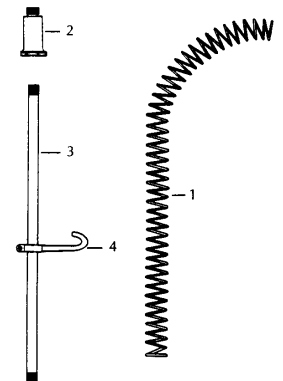

ASK YOUR DUFF SALESPERSON FOR PRICING AND AVAILABILITY!

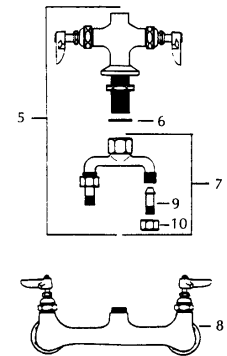

PRE-RINSE PARTS AND ACCESSORIES

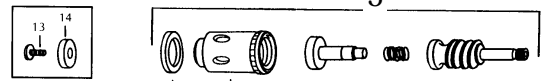

SOLD AS PAIR!

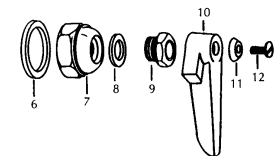

- 4 Seat gasket
- 5 Removable insert - cold
- 5 Removable insert - hot
- 6 Bonnet gasket
- 7 Bonnet
- 8 Packing
- 9 Packing nut
- 10 cold handle
- 10 Hot handle
- 11 Hot index button
- 12 Handle screw
- 13 Seat screw for older stems
- 14 seat washer for older stems

ALL PARTS AVAILABLE IN BULK!

| DESCRIPTION | FIG. NO. | PRICE |
|-------------------------|----------|-------|
| (3) Cold & Hot stem ass | 41767 | |

T&S BRASS REPAIR KITS

B-12K Spindle Kit



Right handle spindle, left handle spindle, 2 screws, 2 seat washers

FIG. NO.

PRICE

41737

B-13K Spindle Kit



Right handle spindle insert and left spindle insert

FIG. NO.

PRICE

41739

B-16K B-0101 Push Button Valve Kit



1 Spring, 2 Bonnet Washers, 2 Hose Washers, 2 Cap Washers, 2 Seat Washers, 2 Packing Stems.

FIG. NO.

PRICE

28810

B-17K Old Style B-0230 Spindle Kit



Right hand spindle, Left hand spindle, 2 seat screws, 2 seat washers.

FIG. NO.

PRICE

41760

B-18K Four Arm Handle Kit - Lab



2 ea 4-arm handles, 2 Handle screws, 1 snap-in index - green-cold, 1 snap-in index - red-hot.

FIG. NO.

PRICE

41761

B-19K Four Arm Handle Kit - Kitchen



2 Four Arm Handles, 2 Handle Screws, 1 Index button-red, 1 Index Button - Blue.

FIG. NO.

PRICE

41765

B-21K Eterna Cartridge Replacement



1 Right hand removable insert assembly, 1 Left hand removable insert assembly

FIG. NO.

PRICE

44995

B-10K Repair Kit for B-0107



2 each of the following: rubber rings, seat washers, binding washers, bonnet washers, packings, springs, and hose washers.

FIG. NO.

PRICE

15710

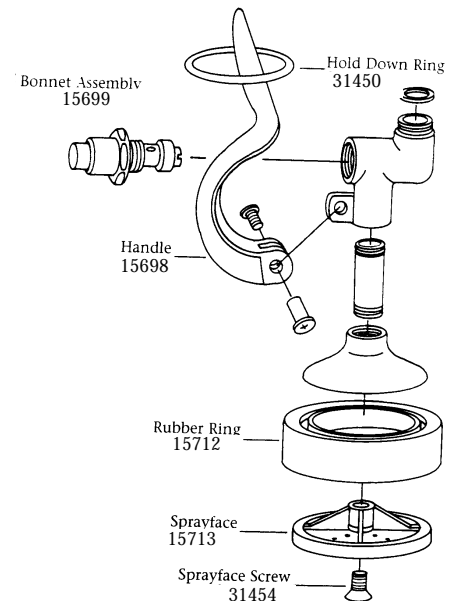

T&S BRASS REPAIR KITS

B-23K
Spring Check Spindle Ass Replacements



1 ea Left hand Eterna spindle with spring check
1 ea Right hand Eterna spindle with spring check

| FIG. NO. | PRICE |
|----------|-------|
| 41767 | |

B-1255
Glass Filler Repair Kit



2 springs, 1 handle screw, 1 handle nut, 2 bonnet washers, 2 hex cap washers, 2 seat washers, 2 stem packings, 1 lever arm.

| FIG. NO. | PRICE |
|----------|-------|
| 29678 | |

B-30K
Range Faucet Parts Kit



1 spring, 4 (00625-45) o-rings, 2 (009267-45) o-rings, 2 (009628-45) o-rings, 2 bearings.

| FIG. NO. | PRICE |
|----------|-------|
| 28812 | |

B-50P
Foot Pedal Valve Parts Kit



4 valve stems, 4 springs, 4 (000974-45) bonnet washers, 4 (009633-45) bonnet washers, 4 seat washers, 4 packing stems

| FIG. NO. | PRICE |
|----------|-------|
| 15702 | |

B-5K
B-230 Faucet Repair Kit



Right hand spindle, Left hand spindle, 6 seats, 6 seat screws, 12 washers, 12 (009635-45) bonnet washers, 12 (00726-45) bonnet washers, 24 o-rings, 12 washers, 12 dome packings.

| FIG. NO. | PRICE |
|----------|-------|
| 28805 | |

B-6K
Eterna Spindle Parts Kit



Right hand Eterna insert, Left hand Eterna insert, Right handle spindle insert, Left hand spindle insert, Seat washer screw, bottom gasket, Top basket, Seat washer, Packing, Washer, D-ring.

| FIG. NO. | PRICE |
|----------|-------|
| 28806 | |

B-7K
Master Parts Kit



12 Right hand Eterna inserts, 6 Left hand Eterna inserts, 12 right hand spindle inserts, 6 Left handle spindle inserts, 6 packing nuts, 50 lever handle screws, 25 Seat washer screws, 25 top gaskets, 25 swing nozzle o-rings, 50 seat washers, 50 packings.

| FIG. NO. | PRICE |
|----------|-------|
| 28807 | |

B-9K
Lever Handle Kit



Lever handle hot, Lever handle cold, index button - red - hot, index button - blue - cold, 2 Lever handle screws.

| FIG. NO. | PRICE |
|----------|-------|
| 41830 | |

B-11K
Externa Cartridge Spindle Kit



Right handle spindle insert, Left hand spindle insert, 2 screws, 2 seat washers.

| FIG. NO. | PRICE |
|----------|-------|
| 43163 | |

ALL US MADE!

ALL US MADE!

KITCHEN FAUCETS

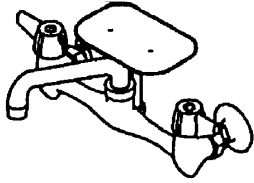

CENTRAL BRASS wall mount combination faucet with 6" standard spout

| DESCRIPTION | FIG NO. | PRICE |
|-------------------|---------|-------|
| Female | 7970 | |
| Fem w/ 12" spout | 7998 | |
| Male | 7936 | |
| Male w/ 8" spout | 7942 | |
| Male w/ 12" spout | 7958 | |

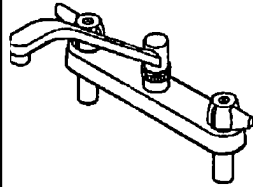

CENTRAL BRASS two handle kitchen faucet 8" center.

| FIG. NO. | PRICE |
|----------|-------|
| 7859 | |

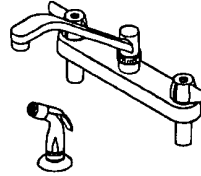

CENTRAL BRASS 2 handle kitchen faucet with spray, 8" center.

| FIG. NO. | PRICE |
|----------|-------|
| 7895 | |

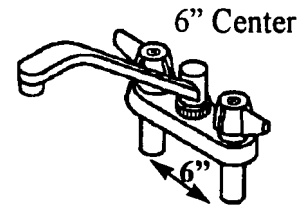

CENTRAL BRASS Deck faucet. Replaces Sears, Rundle.

| FIG. NO. | PRICE |
|----------|-------|
| 7931 | |

WITH SPRAY

| FIG. NO. | PRICE |
|----------|-------|
| 7932 | |

FAX YOUR ORDER FOR FASTEST DELIVERY!
610-279-6299

LAVATORY FAUCETS

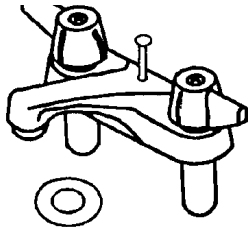

CENTRAL BRASS 2 handle 4" centerset faucet

LESS POP-UP

| FIG. NO. | PRICE |
|----------|-------|
| 7749 | |

WITH POP-UP

| | |
|------|--|
| 7751 | |
|------|--|

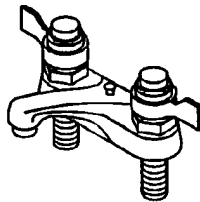

CENTRAL BRASS self-closing, 4" centerset lav faucet

LESS POP-UP

| FIG. NO. | PRICE |
|----------|-------|
| 7758 | |

WITH POP-UP

| | |
|------|--|
| 7760 | |
|------|--|

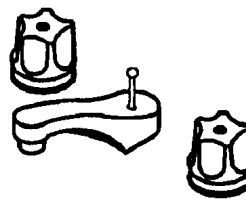

CENTRAL BRASS widespread lav faucet on 6" - 24" centers

LESS POP-UP

| FIG. NO. | PRICE |
|----------|-------|
| 7779 | |

WITH POP-UP

| | |
|------|--|
| 7782 | |
|------|--|

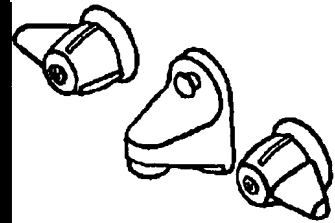

CENTRAL BRASS shelf-back faucet with pop-up 4"-6" adjustable.

| FIG. NO. | PRICE |
|----------|-------|
| 7812 | |

BASIN COCKS

CENTRAL BRASS heavy duty basin cock.

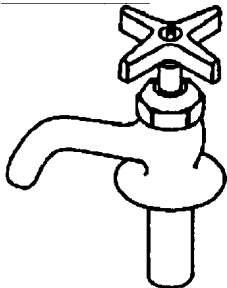

| | FIG. NO. | PRICE |
|------|----------|-------|
| HOT | 44596 | |
| COLD | 7761 | |

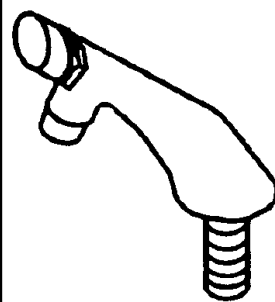

CENTRAL BRASS slow-close basin cock

| FIG. NO. | PRICE |
|----------|-------|
| 7769 | |

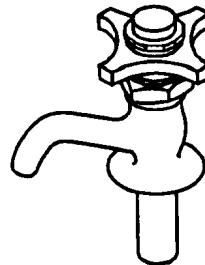

CENTRAL BRASS self-close basin cock

| FIG. NO. | PRICE |
|----------|-------|
| 7763 | |

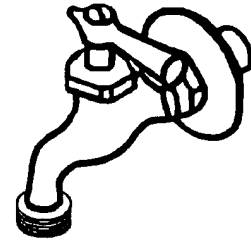

CENTRAL BRASS sink wall bibb.

| | FIG. NO. | PRICE |
|------|----------|-------|
| HOT | 37971 | |
| COLD | 37970 | |

FAUCETS BY CENTRAL BRASS

TUB AND SHOWER FAUCETS

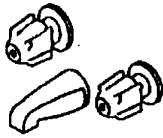

CENTRAL BRASS 2 handle tub filler.

| FIG. NO. | PRICE |
|----------|-------|
| 8207 | |

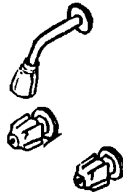

CENTRAL BRASS 2 valve shower only.

| FIG. NO. | PRICE |
|----------|-------|
| 8211 | |

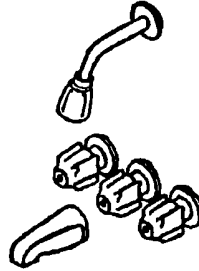

CENTRAL BRASS 8" tub and shower diverter.

| FIG. NO. | PRICE |
|----------|-------|
| 8" | 8222 |
| 11" | 20642 |

ALL U.S. MADE!

ADJUSTABLE ARM BATH COCK

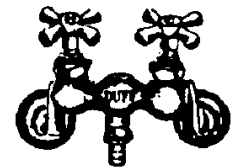

Bath faucet with cast brass body. Arms adjust from 2 1/2" to 8 1/2". Top handle. Chrome plated.

| FIG. NO. | PRICE |
|----------|-------|
| 24409 | |

MISCELLANEOUS FAUCETS

BAR FAUCET

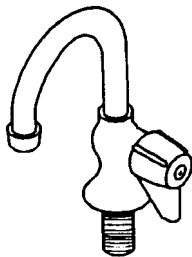

CENTRAL BRASS bar faucet.

| FIG. NO. | PRICE |
|----------|-------|
| 8560 | |

COMBINATION BAR FAUCET

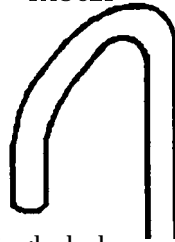

For single hole mounting.

| FIG. NO. | PRICE |
|----------|-------|
| 46860 | |

SERVICE SINK FAUCET

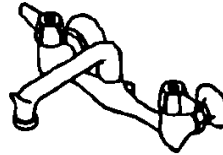

CENTRAL BRASS back mount service sink faucet. Rough Chrome.

| FIG. NO. | PRICE |
|----------|-------|
| 8017 | |

TRIP WASTES

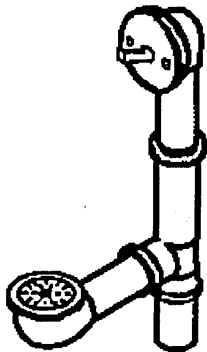

TRIP LEVER TUB DRAIN

| FIG. NO. | PRICE |
|----------|-------|
| 8312 | |

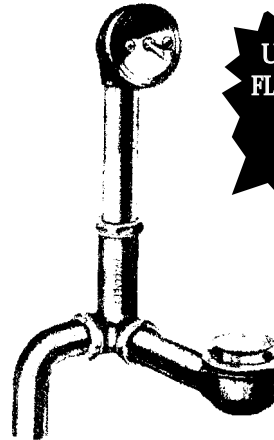

USE WHEN FLOOR JOIST BLOCKS PATH!

SIDE OUTLET DRAIN
pop-up drain with side outlet drain. Chrome plated trim.

| FIG. NO. | PRICE |
|----------|-------|
| 20710 | |

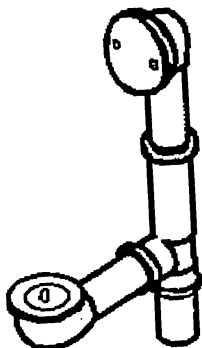

CENTER LIFT TUB DRAIN

| FIG. NO. | PRICE |
|----------|-------|
| 19008 | |



ALSO AVAILABLE IN 1-3/8!

CHAIN & STOPPER BATH DRAIN.
1 1/2" Multi-Tub
Brass face plate
Chrome plated trim

| FIG. NO. | PRICE |
|----------|-------|
| 44319 | |

CENTRAL BRASS PARTS

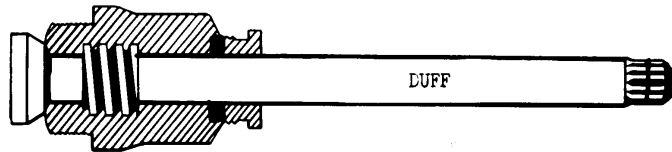

Central Shower Stem Assembly

| FIG. NO. | PRICE |
|----------|-------|
| 8582 | |

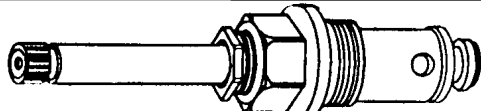

Central diverter Stem Assembly

| FIG. NO. | PRICE |
|----------|-------|
| 8583 | |

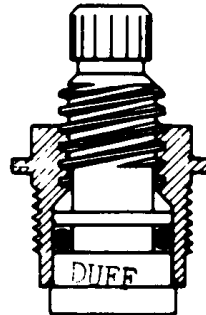

Central Lav Stem

| FIG. NO. | PRICE |
|------------|-------|
| HOT 8604 | |
| COLD 37889 | |

CENTRAL BRASS WASHERLESS STEM



| FIG. NO. | PRICE |
|----------|-------|
| 8605 | |

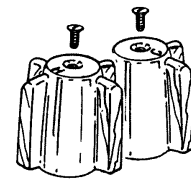

Central brass tub handles. Chrome plated canopy, screws included.

| FIG. NO. | PRICE |
|----------|-------|
| 8616 | |

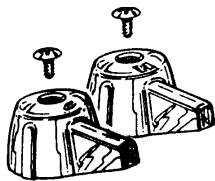

Central brass lav or sink handles. Chrome plated canopy lever, screws included.

| FIG. NO. | PRICE |
|------------|-------|
| HOT 8618 | |
| COLD 44648 | |

CENTRAL BRASS 3127 LAV FAUCET PARTS BREAK DOWN

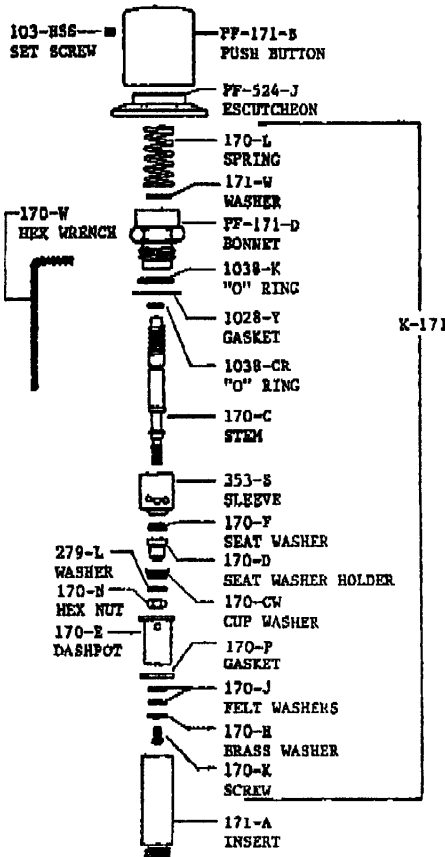

CENTRAL BRASS REPLACEABLE HANDLES

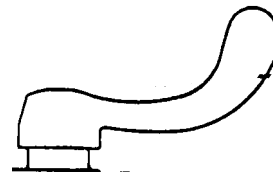

| FIG. NO. | PRICE |
|-----------------|-------|
| 6" Elbow Handle | 8633 |
| 4" Wrist Handle | 8632 |

PLEASE SPECIFY HOT OR COLD INDEX WHEN ORDERING!

CENTRAL BRASS REPLACEABLE SEAT 1/2 x 24



| FIG. NO. | PRICE |
|----------|-------|
| 8599 | |



CENTRAL BRASS SPOUTS

8" SWIVEL TUBE SPOUT WITH AERATOR



| SIZE | FIG. NO. | PRICE |
|------|----------|-------|
| 8" | 8610 | |
| 10" | 8607 | |
| 12" | 8608 | |
| 14" | 8609 | |

5" CAST BRASS SWIVEL SPOUT WITH AERATOR

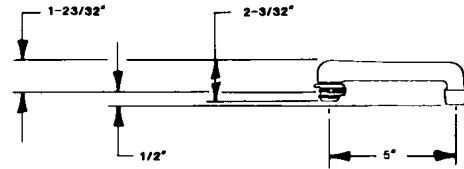

| FIG. NO. | PRICE |
|----------|-------|
| 8628 | |

7" CAST BRASS SPOUT EXTENSION POLISHED CHROME

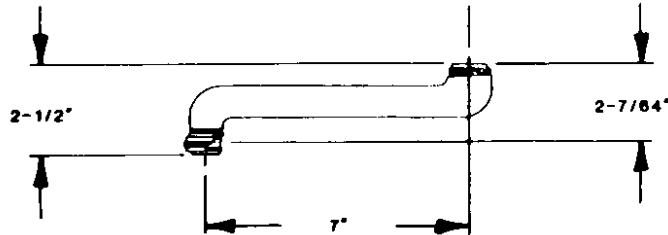

| FIG. NO. | PRICE |
|----------|-------|
| 8624 | |

SWIVEL GOOSENECK SPOUT WITH AERATOR



| SIZE | FIG. NO. | PRICE |
|---------|----------|-------|
| 4-3/32" | 8595 | |
| 6-1/2" | 35785 | |

BRASS SWIVEL "D" SPOUT WITH AERATOR

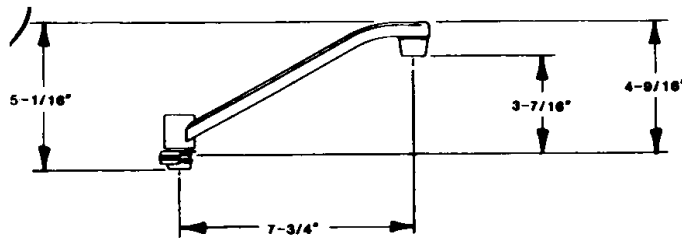

| FIG. NO. | PRICE |
|----------|-------|
| 8611 | |

7-1/4" SWIVEL HIGH RISE SPOUT WITH AERATOR

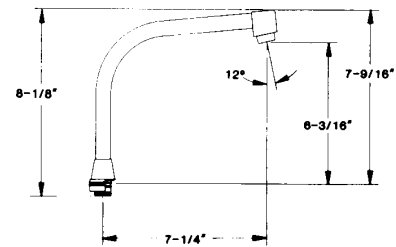

| FIG. NO. | PRICE |
|----------|-------|
| 48540 | |



POWERS MIXING VALVES



Series 420 Thermostatic Valves. Scalds or thermal shock (hot or cold) can result from pressure and/or temperature changes in the supply water inlet lines. The ultimate in safety, the Powers Process Controls' **Series 420 HYDROGUARD** thermosttic valves for

single unit shower systems maintain the temperature dialed in by the user, despite variations in inlet supply pressure or temperature.

A liquid filled thermosttic motor reacts immediately to temperature changes to ensure rapid and positive control of output temperature. The Series 420 is available in a wide variety of configurations including low temperature modesls designed for hot water supplies less than 125° F.

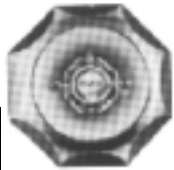

Series 2000



Series 410

Series 2000/410 Pressure Equalizing Valves.

Sudden shower temperature changes due to supply water inlet pressure changes are eliminated with the Power Process Controls' Series 2000 and 410 HYDROGUARD pressure equalizing valves. A diaphragm operated poppet immediately responds to any pressure change to maintain consistent pressures between the cold water and hot water supply lines. These large capacity (6 GPM) valves come with a wide variety of options including lever handles and integral volume control. These valves are also available as 4 port models to facilitate tub/shower installations.

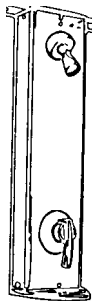

Series 450 Hydropanel. The Series 450 HYDROPANEL provides the same safety and comfort of the HYDROGUARD shower vavles in a surface-mounted, prefabricated shower panel. These units are excellent for renovations where existing valves and piping can be by-passed without major wall reconstruction.

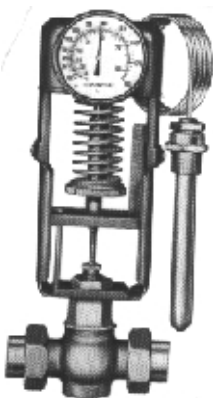

Central Mixer - #11A Regulator. Self contained regulator provides protection for the entire hot water system. The No. 11 can be located at the central water heater to permit storing water at higher temperatures and then reducing the water temperatures for safe hot water supply temperatures to buidling fixtures. The No. 11 is self actuated and thus, requires no external power source. In addition tot he three-way water mising configuration, the No. 11 is available with a wide variety of seat styles and materials for use with two-way No. 11 regulators to control wth supply of a heating medium such as steam.

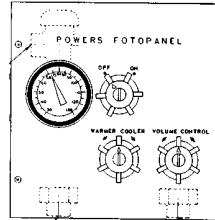

Fotoguard/Fotopanel. Processing photographic and X-Ray film requires precise temperature control to prevent clouded or spoiled film. The sereis 440 FOTO-GUARDS and FOTOPANELS permit the user to select precise temperatures and volumes over a wide range by employing the principles of the HYDROGUARD thermostatic mixing valves.

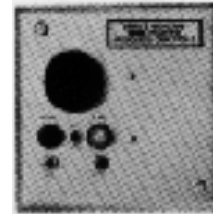

460 Alarm. The Series 460 Alarm provides an extra margin of safety by monitoring critical water temperatures. In the event of excessive hot water temperatures the Series 460 Alarm not only acts as an annunciator, but also serves as a safety shutdown device to prevent flow until the alarm condition is corrected.

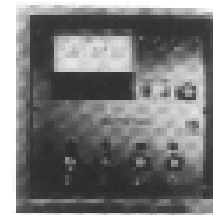

Series 460 Showertrol. The Series 460 SHOWERTROL system provides complete monitoring and supervision over water supplied to shower room from a remote location. The Series 460 SHOWERTROL can perform the following for select shower banks:

- *On/off control
- *Timer Control of shower duration
- *Temperature monitoring/adjustment of master mixing valve

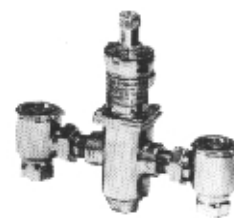

Dedicated Mixer Series 430 Thermostatic

The Series 430 high capacity mixing valve provides thermostatic protection and supervision over groups of individual fixtures or a single large demand fixture.

Providing an accuracy of $\pm 3^{\circ}\text{F}$ even with up to 50% drop in inlet pressures or 25° F fluctuation in hot water supply temperature or 85% restriction of outlet flow rte, the Series 430 is available in four sizes to handle flows up to 125 GPM at a 45 PSI pressure drop.

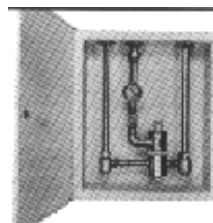

Thermostatic Supply Fixtures. For maximum safety, reliability and security, the Powers Process Controls' thermostatic valves can be pre-engineered as supply fixtures and cabinets for ease of installation and protected access to controls.

PLUMBING
POWERS 900 SERIES

DUFF CO.

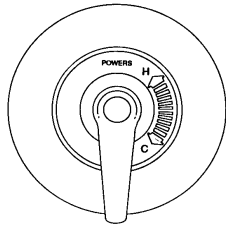

Concealed, 4 port, pressure balancing mixing valve for use in shower and tub/shower applications. Uses diaphragm type pressure balancing mechanism. All internal parts made of lime resistant Celcon polymer for extended trouble free service. Integral adjustable limit stop reduces possible over adjustment of handle to restrict hot water mix. Cast brass body, chrome plated ABS face plate with color graphic insert, ergonomically designed chrome plated ABS lever type handle, and corrosion resistant material throughout ensure years of trouble free service. Cast-in integral checkstops reduce installation time. Unique construction allows for shallow wall installation - in as little as 2" (51mm). Back -to-back installation possible in only 4" without costly cross-piping.

| FIG. NO. | PRICE |
|----------|-------|
| 59514 | |

INCLUDES: Valve, arm & flange, showerhead & threaded diverter spout!

POWERS 420 SERIES

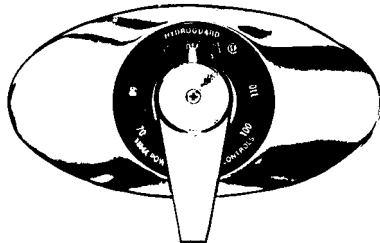

Concealed thermostatic water mixing valve for use on shower and tub/shower installations. Powerful liquid-filled motor compensates for both temperature and pressure fluctuations. A built-in adjustable temperature limit stop reduces changes of accidental scalding due to overadjustment of handle.

Features:

Heavy cast brass body, durable stainless steel faceplate, die-cast, lever-type handle and corrosion-resistant material throughout ensures years of trouble-free service.

T425 Thermostatic valve 1/2 NPT 3 port

T426 Thermostatic valve 1/2 NPT 4 port

| FIG. NO. | PRICE |
|----------|-------|
| 47995 | |

| FIG. NO. | PRICE |
|----------|-------|
| 47997 | |

POWERS 430 SERIES

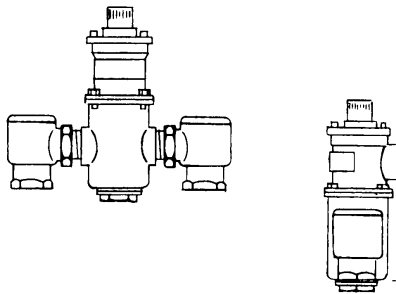

The 430 Hydroguard thermostatically blends hot & cold water to deliver blended water at the desired temperature, compensates for both temperature and pressure changes in the supply lines and reduces flow upon water supply pressure failure.

Features:

The dirt and lime resistant poppet and seat design ensure minimal maintenance while the union outlets allow a variety of piping schemes. Heavy duty combination strainer checkstops included with each valve, prevents crossover and allows easy shutdown.

| FIG. NO. | TEMP. RANGE | FIG. NO. | PRICE |
|---|--|-------------------------|-------|
| 431 Inlets/Outlets 3/4" / 3/4" Weight: 11.5 lbs | 40° to 90°F / 4° to 32°C 65° to 115°F / 18° to 46°C 85° to 160°F / 29° to 71°C | 79059 79060 54758 | |
| 432 Inlets/Outlets 3/4" / 1" Weight: 14.0 lbs | 40° to 90°F / 4° to 32°C 65° to 115°F / 18° to 46°C 85° to 160°F / 29° to 71°C | 67863 59385 79061 | |
| 433 Inlets/Outlets 1 1/4" / 1 1/4" Weight: 26.0 lbs | 40° to 90°F / 4° to 32°C 65° to 115°F / 18° to 46°C 85° to 160°F / 29° to 71°C | 79062 59518 79063 | |
| 434 Inlets/Outlets 1 1/4" / 1 1/2" Weight: 30.0 lbs | 40° to 90°F / 4° to 32°C 65° to 115°F / 18° to 46°C 85° to 160°F / 29° to 71°C | 79064 58666 59523 | |

For additional information call: 610-275-4453 or Fax: 610-279-6299
Please call for current prices.

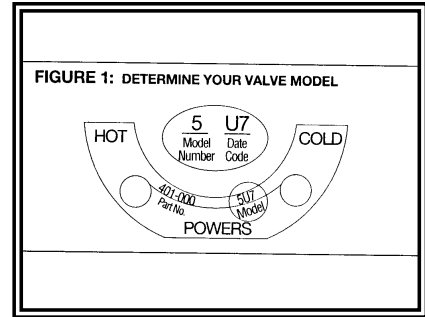
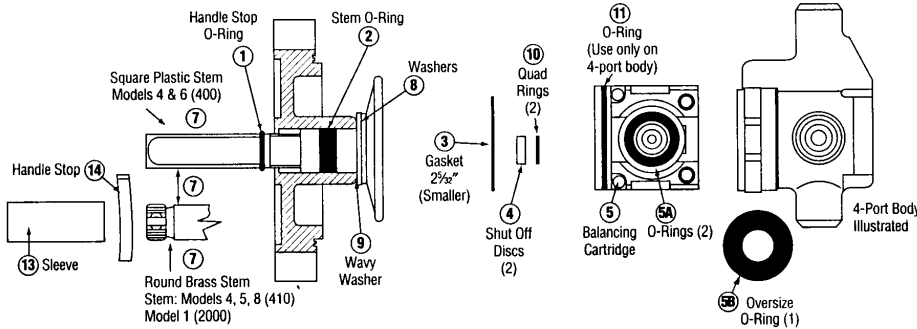

| TROUBLESHOOTING | | USED WHERE | FIG. NO. | REPAIR KIT INCLUDES | |
|--|---|-----------------------------|---|---|--|
| Cartridge slips while seated in body. Flow continues after mixer is turned off, and all other seals have been replaced. | Oversize 410 Inlet Seal Kit | 400,410 and 2000 all models | 78903 | 1-4,5a,5b*,10,11 Use item 11 only in models 4-6, 4-port body (see note1 below) | |
| | 1. Water leak at stem and/or bonnet. 2. Flow continues after mixer is turned off. | Gasket and Disc Replacement | 400, 410 and 2000 all models | 45098 | 1-4, 5a, 10, 11 Use in item 11 only in models 4-6 4-port body (see note1 below) |
| | 1. Variable or untempered discharge temperature. 2. Leakage after mixer is turned off. | Balance Chamber | 400: models 4-6 410: models 4,5 2000: model 1 410: model 8 | 45095 45099 | 3-5, 5a, 10, 11 Use item 11 only in models 4-6 4-port body (see note1 below) 3-5,5A,13,15,16 |
| | 1. Flow continues after mixer is turned off. 2. Handle splines on stem damaged. | Stem and plate replacement | 400: models 4-6 410: all models 2000: all models | 45096 45100 | 1-4,7-9 Item 7 has square plastic stem and plate (see note2 below) 1-4,7-9 Item 7 has round brass stem and plastic plate |

NOTE1: O-ring, item 11 is used only in 4-port mixers

NOTE2: "C" on stem must face cold water inlet. For model 4-400, you must also order new handle for new brass stem. Order either lucite handle kit #410-383 or lever handle kit #41-0384

HYDROGUARD 400 - MODELS 4 & 6 HYDROGUARD 410 - MODELS 4, 5, 8 HYDROGUARD 2000 - MODEL 1

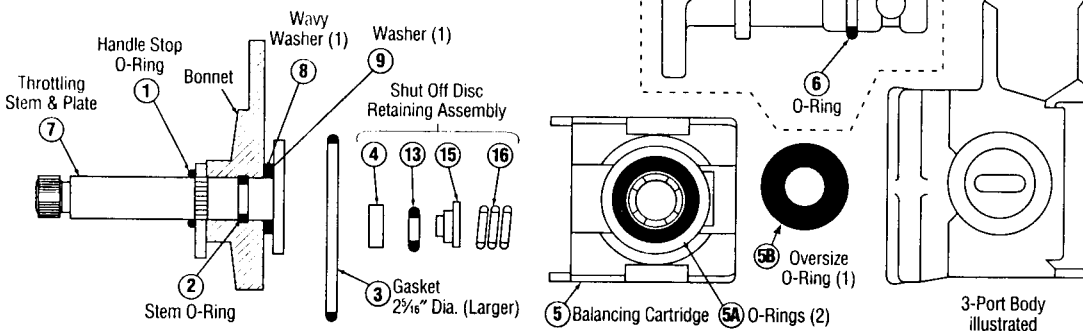

ALL PARTS AVAILABLE IN BULK!

| TROUBLESHOOTING | | USED WHERE | FIG. NO. | REPAIR KIT INCLUDES | |
|--|---|-----------------------------|---|---------------------|--|
| 1. Cartridge slips while seated in body. 2. Flow continues after mixer is turned off, and all other seals have been replaced. | Oversize 410 Inlet Seal Kit | 400/410 All models | 78903 | 1-4,5A,5B*,6 | |
| | 1. Water leak at stem and/or bonnet. 2. Flow continues after mixer is turned off. | Gasket and Disc Replacement | 400/410 All models | 45098 | 1-4, 5A, 6 |
| | 1. Variable or untempered discharge temperature. 2. Leakage after mixer is turned off. | Balance Chamber | 400: models 1-3 410: models 1-3, 7 Metal and Plastic Bonnet | 45099 | 3-5, 5A, 13, 15, 16 |
| | 1. Flow continues after mixer is turned off. 2. Handle splines on stem damaged. | Stem and plate replacement | 400: models 1-3 410: all models 419's Only | 45100 78902 | 1-4,7-9 1-4,7-9 1-4,7-9 (shorter stem) |

*Use O-ring only on Hydroguard 412/414. Others use gasket. **Item 7 has brass stem and Celcon Plastic Mixing Plate

***When using oversize O-ring (item 5B), discard one of the two regular sized O-rings (5A) normally used and use item 5B in its place.

POWERS REPAIR KITS

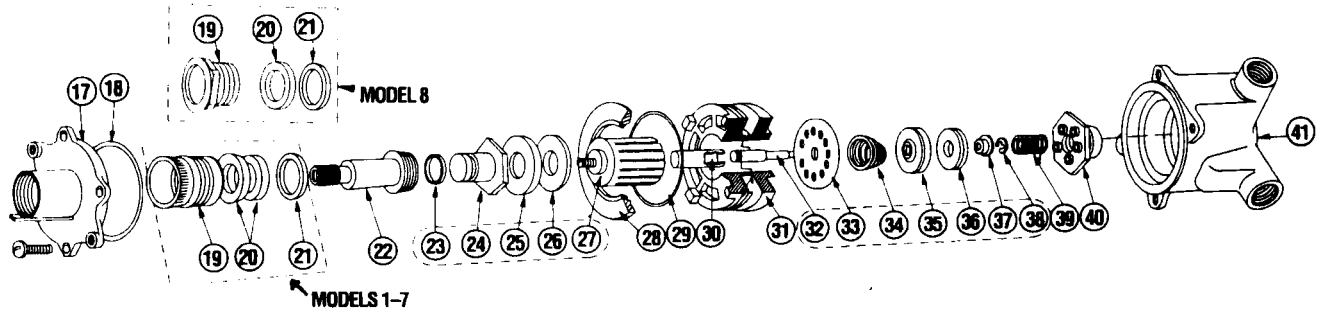

ALL POWERS PARTS AVAILABLE IN BULK!

| PROBLEM | TYPE OF KIT | FIG. NO./ITEM NUMBERS | PRICE |
|---|--|--|-------|
| Water leaks at valve stem and/or bonnet Water leaks at valve shut-off | Gasket and Disc Replacement | 45084 18,18A.,20,23,26,29 | |
| Variable or untempered discharge temperature Water leaks at valve shut-off due to worn hot water seat | Motor Replacement | 78989 (40-90°F) 45085 (65-115°F) 64494 (120-175°F) 18,18A,23-27,30 | |
| Variable or untempered discharge temperature continues after motor replacement | Valve and hot water Seat replacement | 47196 (model 1,2,3,4) 45086 (model 5,6,7,8) 18,18A,29,32,33,34 | |
| Water leaks at valve shut-off, shut-off disc and/or hot water seat have been replaced | Combination seat Replacement (6GMP mixer) | 45087 18,18A,28,29,31 | |
| For use when hot water supply temperature is below 120°F allows discharge temperature to be within 2°F of hot water supply | Low temperature conversion kit (110°F) | 48503 18,18A,28-31 | |
| Complete Bonnet Assembly Includes items 13,14, 16-22, 28 | Model 1-3, convert to model 8 - FIG. NO. 48414 Model 1-4 FIG. NO. 78982 Models 7-8 FIG NO. 48414 | | |
| COMPLETE BONNET ASSEMBLY, TO CONVERT MODE 1-3 to MODEL 8 (use model 8 bonnet, oval dial and lever handle (discard old stem)) | Bonnet Assembly - FIG. NO. 48414 Oval Dial Assembly - FIG. NO. 78985 Lever Handle - FIG. NO. 47199 | | |

REPAIR/INSTALLATION INSTRUCTIONS - HYDROGUARD ACCESSORIES

REPAIR PARTS

| ITEM | 141-176 | 141-177 | 141-187 | 141-326 | DESCR |
|------|---------|---------|---------|---------|----------|
| 1 | 230-295 | - | 230-296 | 230-296 | Vlv Body |
| 2 | 445-134 | 445-135 | 445-134 | 445-134 | Adj Stem |
| 4 | 445-136 | 115-137 | 445-136 | 445-136 | Bonnet |

To replace internal parts, use repair kit 48501 (includes items 3,5,6,7,8 and 9)

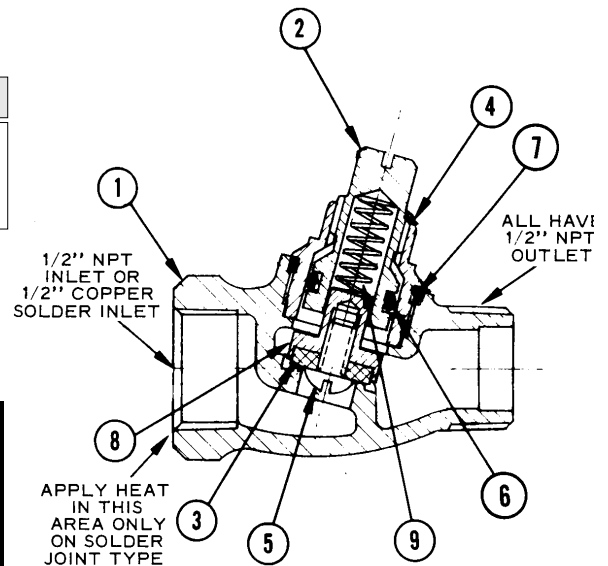

**IF YOU DON'T SEE IT,
CONTACT YOUR DUFF
REPRESENTATIVE**

For additional information call: 610-275-4453 or Fax: 610-279-6299
Please call for current prices.

POWERS TROUBLESHOOTING

| PROBLEM | DIAGNOSIS | RECOMMEDED SOLUTION |
|---|---|---|
| MOTOR REPLACEMENT | The water flowing from the showerhead varies in temperature or is untempered hot or cold. | a. Lime deposits may have accumulated in the hot water pipes, restricting water flow. |
| | | b. The thermostatic motor may have failed. |
| | | c. The inlet water supplies may be connected to the wrong ports. |
| | | d. There may be extreme pressure variations in the water supply lines. |
| GASKET AND DISC REPLACEMENT | Water is still untempered after motor replacement | The shut-off disc may be worn. |
| | Water leaks from the valve or showerhead after shutoff | The shut-off disc may be worn. |
| COMBINATION SEAT REPLACEMENT | Water leaks from the valve or showerhead after shutoff. | Combination seat O-ring may be worn. |
| VALVE AND HOT WATER SEAT REPLACEMENT | Water leaks at valve shut-off due to worn hot water seat. | Worn hot water seal should be replaced. |
| | Variable or discharge temperature continues after motor replacement. | Worn hot water seal should be replaced. |
| BONNET GASKET, HUVA CUP, OR MOTOR QUAD RING REPLACEMENT | Valve leaks only at the stem and/or bonnets. | Bonnet gaskt, huva cup, or motor quad ring may be worn. |

| DESIRED CONVERSIONS | ITEMS NEEDED | ITEMS TO ORDER |
|---------------------|--|---|
| UPGRADE KITS | To convert Models 1-3 to Model 8 To convert Models 1-6 to Model 8 | Updated bonnet, dial and lever handle needed. |
| UNIVERSAL HANDLE | For Models 406 to accept the universal lever handle | Adjustment stem and temperature stop needed. |
| BONNET REPLACEMENT | Bonnet for Models 1-3 | Updated bonnet, dial and lever handle needed. |
| | Bonnet for Models 4-6 | Bonnet replacement only needed |
| | Bonnet for Models 7-8 | Bonnet replacement only needed. |
| HIGH CAPACITY KIT | To convert Modesl 5-9 in high capacity | Conversion kit needed. |
| LOW CAPACITY KIT | To convert Models 5-9 in low capacity | Coinversion kit needed. |

POWERS TROUBLESHOOTING, (CONT'D)

WHAT TO LOOK FOR IF:

If the maximum temperature cannot be obtained...

- a. Lime deposits may have accumulated in the hot water pipes, restricting the hot water supply.
- b. The hot water supply temperature may be too low.
- c. The handle rotation setting may be too low. Remove valve handle, and readjust the handle rotation stop (see Setting the Handle Rotation Stop).
- d. If the valve is more than 10 years old (refer to date code or call your powers application engineer), erosion may have affected parts of the valve body, Model 9 use kit #420-557. Models 1-8 use Low Temperature Hot Water Conversion Kit #420-203

If the valve opens with hot water flow rather than cold water flow...

The inlet water supplies are connected to the wrong parts. Remove the valve and reinstall.

If the tempered water is too cold, although motor has been replaced, OR the hot water temperature is below 120°F...

- a. Raise the temperature of the hot water supply.
- b. The hot water temperature is too low for the valve to control properly.
 Model 9: use low temperature hot water conversion kit #420-557
 Models 1-8: use low temperature hot water conversion kit #420-203

If the flow of water is less than desired...

- a. The upstream supply valve may not be fully open.
- bc. the inlet supply pressure(s) may be low.
- c. Lime deposits may have accumulated in the he hot water pipes, restricting water flow.
- d. The showerhead may be clogged. Remove and clean.
- e. The checkstops may be clogged. Refer to preventive maintenance section and form #129-028.

If the flow of water is completely shut off...

- a. The upstream supply valves may be completely closed.
- b. The hot or cold water supply pressure may have failed. The Hydroguard 420 valve is designed to close down upon cold water failure.
- c. The checkstops may be closed. Access the checkstops and open by turning the adjustment screw fully counter clockwise.

**DUFF KNOWS...
 TIME IS MONEY!
 CALL OR FAX
 YOUR ORDER
 FOR FAST SERVICE**

CHECK STOPS

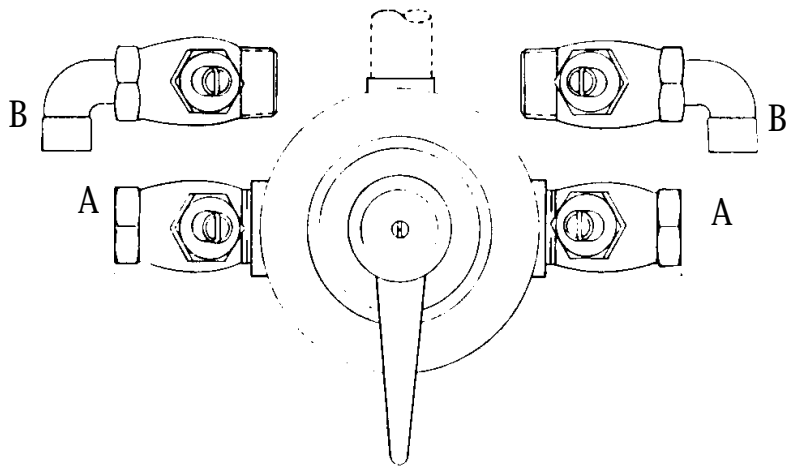

| DESCRIPTION | DIA | FIG. NO. | PRICE |
|--|-----|----------|-------|
| 1/2" NPTS threaded inlet straight rough bronze | A | 141-176 | |
| 1/2" copper solder inlet straight rough bronze | A | 141-187 | |
| 1/2" copper solder inlet angle rough bronze | B | 141-326 | |

POWERS 430 SERIES REPAIR KITS

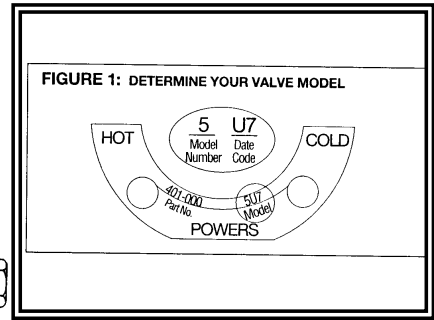
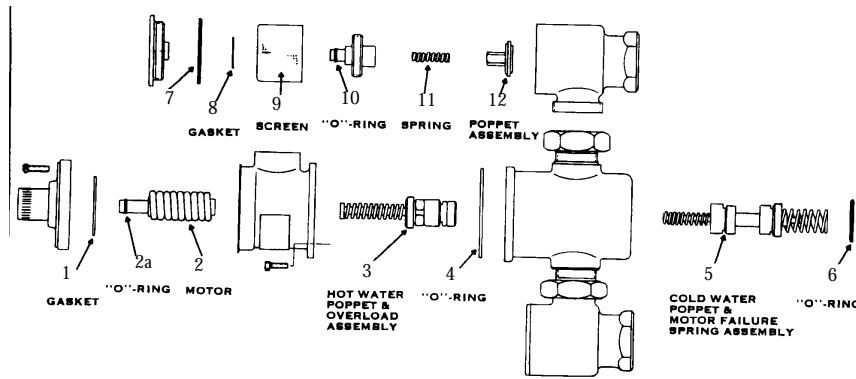

| | | 431 | 432 | 433 | 434 |
|---------------------------|------------------------------|--|---|--|---|
| Motor Replacement | 1, 2, and 2A | 40°-90°F/78998 65°-115°F/45091 85°-160°F/67285 | 40°-90°F/78999 65°-115°F/45092 85°-160°F/ | 40°-90°F/79000 65°-115°F/45093 85°-160°F/59520 | 40°-90°F/7900 65°-115°F/45094 85°-160°F/86328 |
| Strainer Replacement | 7, 8, 9 and 10 | 75963 | 75963 | 79002 | 79002 |
| Checkstop Replacement | 7, 8, 10, 11 and 12 | 45089 | 45089 | 45090 | 45090 |
| Gasket & disc Replacement | 1, 2A, 4, 6, 7, 8, 10 and 12 | 79003 | 75965 | 79004 | 79005 |
| Mixing Valve Replacement | 1, 3, 4, 5, and 6 | 79006 | 75964 | 48502 | 64933 |

POWERS 900 SERIES REPAIR KITS

CALL FOR PRICES ON PARTS NOT LISTED IN KIT FORM!

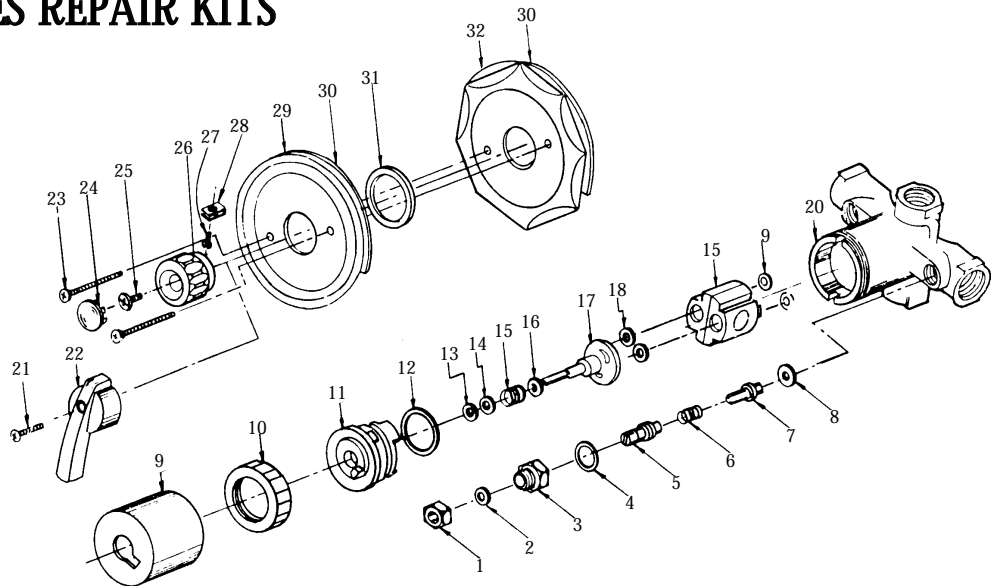

| | TROUBLESHOOTING | DESCR | FIG. NO. | PRICE |
|--|---|---|----------------|-------|
| Gasket and disc replacement (mixer and checkstops) | Water leaks at valve stem and/or bonnet Water leaks at valve shut-off Water leaks at checkstop. | 2(2), 4(2), 8(2), 12, 13, 16, 18(4) | 78904 | |
| Internals Replacements | With mixer handle in MID position hot water flows with cold water check stop closed or cold water flow with hot water checkstop closed. | (Model 1) (Model 2) 11, 12, 13, 14, 15, 16, 17, 18(4), 19 | 45104 45103 | |
| Checkstop Replacement | Checkstop will not completely shut-off. | (2 ea) 1, 2, 3, 4, 5, 6, 7, 8 *Moel 1-use white TFE gasket | 45105 | |

SYMMONS PARTS

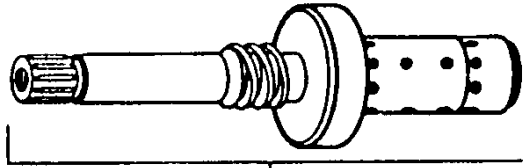

4-1/2" **TEMPROL**

| | |
|--------------------------------|-------|
| Temprol spindle assembly TA-10 | |
| FIG. NO. | PRICE |
| 58521 | |

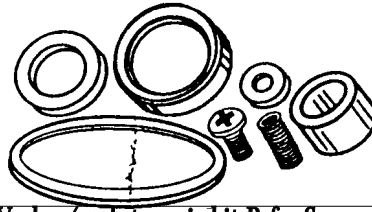

Washer/gasket repair kit B for Symmons Safety Mix spindle

| | |
|----------|-------|
| FIG. NO. | PRICE |
| 58522 | |

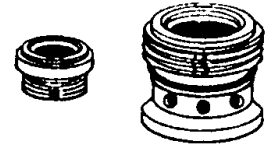

Hot and cold seat repair kit TA-4 for Symmons Temprol spindle

| | |
|----------|-------|
| FIG. NO. | PRICE |
| 53968 | |

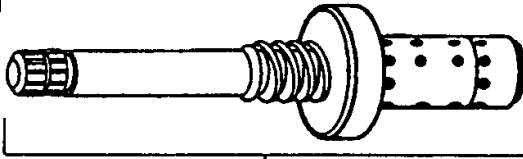

5-1/4" **SAFETY MIX**

| | |
|--|-------|
| Symmons Safety Mix spindle assembly C5 | |
| FIG. NO. | PRICE |
| 47675 | |

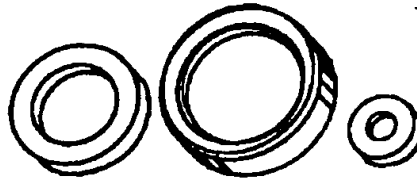

Symmon BT9 repair kit for TA-10 and C-5

| | |
|----------|-------|
| FIG. NO. | PRICE |
| 60454 | |

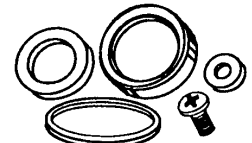

Washer repair kit TA-9 for Symmons Temprol spindle

| | |
|----------|-------|
| FIG. NO. | PRICE |
| 58524 | |

ALL SYMMONS PARTS AVAILABLE IN BULK!

Symmon Tempering Valves
Adjusts Temperature

To supply tempered water to a single faucet. 3/8 compression connection. Adjustable temperature, chrome finish.

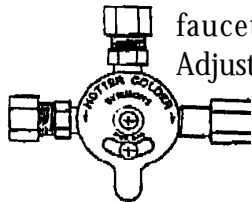

| | |
|----------|-------|
| FIG. NO. | PRICE |
| 60452 | |

Symmons Metering Faucet Typical

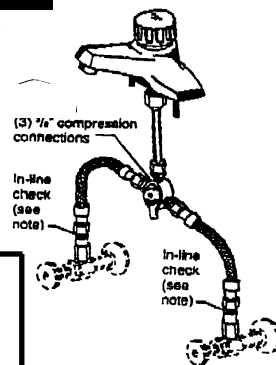

DUFF TIP

Don't forget to order your supply stops and faucet connectors!

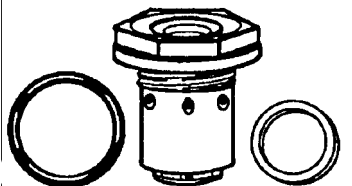

Symmons 3 piece repair kit to renew seat.

| | |
|----------|-------|
| FIG. NO. | PRICE |
| 43358 | |

To supply tempered water to the hot inlet of a two supply faucet.

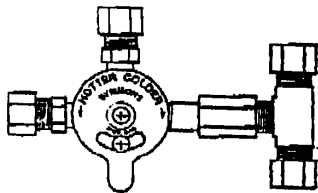

| | |
|----------|-------|
| FIG. NO. | PRICE |
| 60453 | |

Symmons Single Lever Faucet Typical

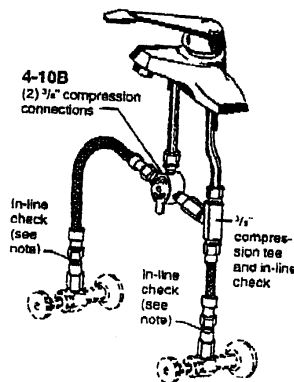

DUFF TIP

Don't forget to order your supply stops and faucet connectors!

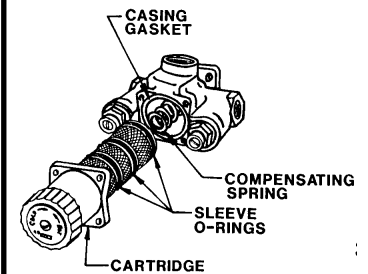

CARTRIDGE UNITS AVAILABLE

FOR

5-200C, 5-400C, 5-500C,
5-700C, 5-900C, 5-1000C

MOEN KITCHEN FAUCETS

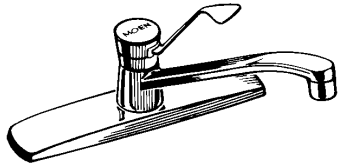

MOEN 7300 Legend single handle kitchen faucet. 2.2GPM. Chrome.

| FIG. NO. | PRICE |
|----------|-------|
| 41867 | |

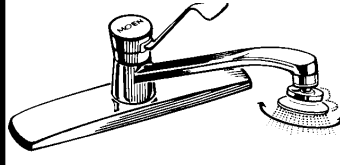

MOEN 7305 Legend single handle kitchen faucet with triple action aerator.

| FIG. NO. | PRICE |
|----------|-------|
| 44712 | |

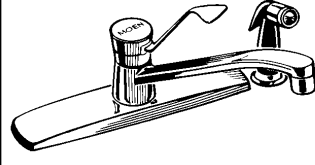

MOEN 7310 Legend single handle kitchen faucet with spray.

| FIG. NO. | PRICE |
|----------|-------|
| 41868 | |



MOEN 7551 Chateau single handle kitchen faucet. Chrome.

| FIG. NO. | PRICE |
|----------|-------|
| 42433 | |



MOEN 7430 Chateau single handle kitchen faucet with spray.

| FIG. NO. | PRICE |
|----------|-------|
| 82122 | |



MOEN 7425 Chateau single handle kitchen faucet.

| FIG. NO. | PRICE |
|----------|-------|
| 82123 | |



MOEN 4901 Chateau Bar Faucet 3 1/2" spout reach, 10" spout height with metal lever handle and 4" centerset. For stainless steel sinks only.

| FIG. NO. | PRICE |
|----------|-------|
| 47120 | |

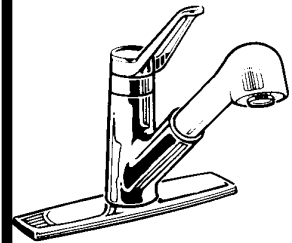

MOEN 7385W One Touch single handle kitchen faucet.

- *Pull out spray
- *Pivot-action handle
- *Washerless cartridge
- *8" deck plate install
- *One or three hole install
- *Lifetime warranty
- * Glacier White

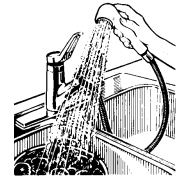

| FIG. NO. | PRICE |
|----------|-------|
| 47603 | |

MOEN LAVATORY FAUCETS

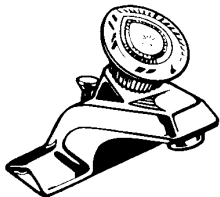

MOEN 4621 Chateau single handle lavatory faucet with waste ass. Chrome.

| FIG. NO. | PRICE |
|----------|-------|
| 41863 | |

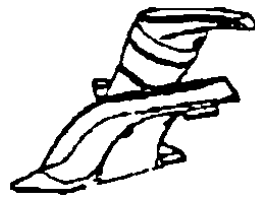

MOEN L4621 Chateau Single handle lavatory faucet with waste ass. Chrome.

| FIG. NO. | PRICE |
|----------|-------|
| 54317 | |

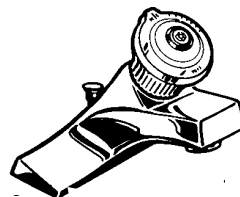

MOEN 4220 Legend single handle lavatory faucet with waste assembly. Chrome.

| FIG. NO. | PRICE |
|----------|-------|
| 41861 | |

MOEN Chateau tub/shower acrylic handle.

| FIG. NO. | PRICE |
|----------|-------|
| 41910 | |

MOEN round lav single handle fits Legend & Moentrol. Acrylic canopy. Includes button & screw.

| FIG. NO. | PRICE |
|----------|-------|
| 41895 | |

MOEN cap and cover assembly fits Chateau. Acrylic canopy. Includes button & screw. Showers - Legend and Moentrol

| FIG. NO. | PRICE |
|----------|-------|
| 41896 | |

MOEN teardrop lav single handle fits Boutique, Chateau and Moentrol. Acrylic canopy. Includes button & screw.

| FIG. NO. | PRICE |
|----------|-------|
| 41909 | |

MOEN SHOWER VALVES

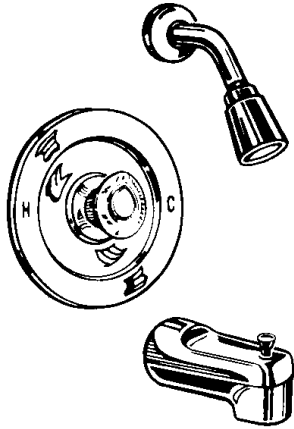

MOEN 2739 Chateau single handle tub and shower set. Chrome.

| FIG. NO. | PRICE |
|----------|-------|
| 41857 | |

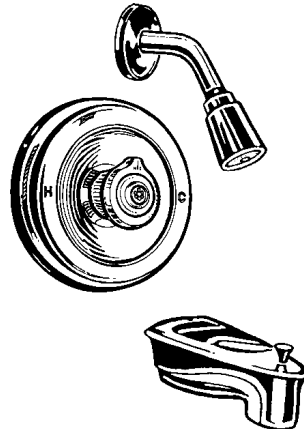

MOEN 2235 Legend single handle tub/shower set. Chrome.

| FIG. NO. | PRICE |
|----------|-------|
| 41855 | |

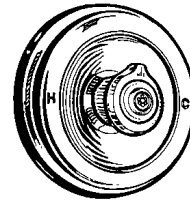

MOEN Legend Valve Only.

| FIG. NO. | PRICE |
|----------|-------|
| 41854 | |

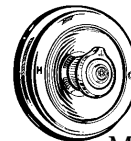

STOPS SHOWER SHOCK!

MOENTROL shower valve only. Volume control, pressure balanced. Chrome.

| FIG. NO. | PRICE |
|----------|-------|
| 44120 | |

MOEN SHOWER VALVES

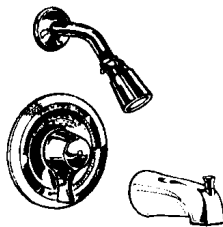

MOEN 2352 PosiTemp single handle pressure balance with 1/4 turn stops, metal handle. Showerhead, arm & flange. Chrome

| FIG. NO. | PRICE |
|----------|-------|
| 71338 | |

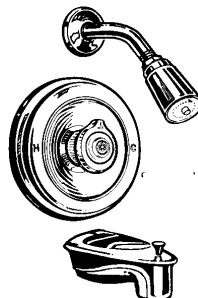

MOEN 3189 Moentrol valve, volume control, pressure balanced tub/shower set. Chrome.

| FIG. NO. | PRICE |
|----------|-------|
| 41860 | |

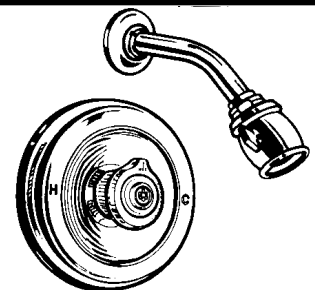

MOEN 3175 Moentrol - volume control, pressure balanced shower valve. Chrome.

| FIG. NO. | PRICE |
|----------|-------|
| 48447 | |

STOP
WASTING TIME
CALL DUFF FIRST!



ALL PARTS AVAILABLE IN BULK!

MOEN PARTS

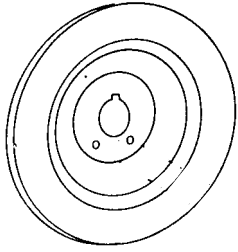

MOEN Chateau
Eschutcheon

| FIG. NO. | PRICE |
|----------|-------|
| 41901 | |

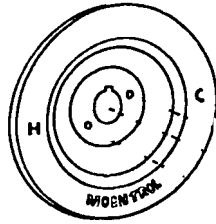

MOENTrol Single
Handle Knob Tub
and Shower Valve

| FIG. NO. | PRICE |
|----------|-------|
| 76773 | |

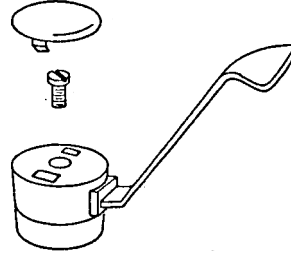

MOEN Legend Lever
Handle Kit

| FIG. NO. | PRICE |
|----------|-------|
| 41886 | |

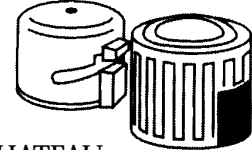

CHATEAU

MOEN cap and cover.

| FIG. NO. | PRICE |
|--------------------|-------|
| 41908 | |
| MOEN Chateau Lever | |
| 41894 | |



Moen Cartridge.

| FIG. NO. | PRICE |
|----------|-------|
| 15117 | |



Moen Magnum Cartridge

| FIG. NO. | PRICE |
|----------|-------|
| 39286 | |



Moen balance spool.

| FIG. NO. | PRICE |
|----------|-------|
| 41882 | |

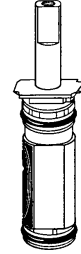

Moen
Posi-
Temp
Cartridge

| FIG. NO. | PRICE |
|----------|-------|
| 47116 | |

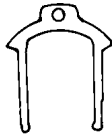

Moen #883 Retainer

| FIG. NO. | PRICE |
|----------|-------|
| 41876 | |

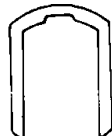

Moen #1883 Retainer

| FIG. NO. | PRICE |
|----------|-------|
| 41884 | |

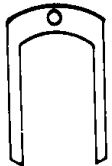

Retainer Clip

| FIG. NO. | PRICE |
|----------|-------|
| 41883 | |

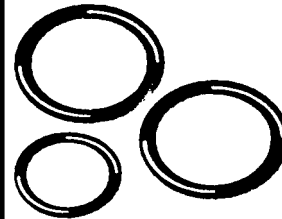

Moen Spout Seals.
3 peice kit

| FIG. NO. | PRICE |
|----------|-------|
| 35627 | |



Moen 8" Spout

| FIG. NO. | PRICE |
|----------|-------|
| 41906 | |

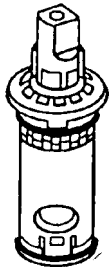

Moen Stem for
2-handle faucet.

| FIG. NO. | PRICE |
|----------|-------|
| 38360 | |

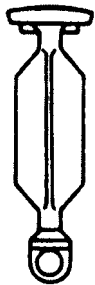

Moen Pop-Up

| FIG. NO. | PRICE |
|----------|-------|
| 41893 | |

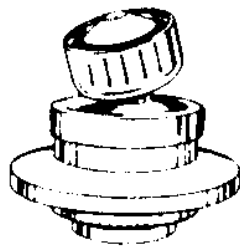

Moen swivel spray.
Chrome.

| FIG. NO. | PRICE |
|----------|-------|
| 41902 | |

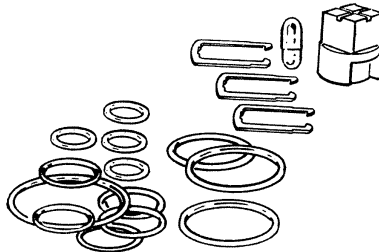

Moen Repair kit for Magnum car-
tridges; contains 2 side seals, 10 O-
rings, 3 clips, installation tool & lubri-
cant capsule.

| FIG. NO. | PRICE |
|----------|-------|
| 55739 | |

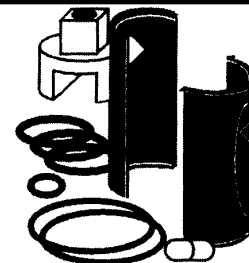

Moen Repair kit for Posi-Tmp
cartridges; contains 2 side
seals, 6 O-rings, installation
tool & lubricant capsule.

| FIG. NO. | PRICE |
|----------|-------|
| 55741 | |

FAUCETS BY DELTA

KITCHEN AND LAV

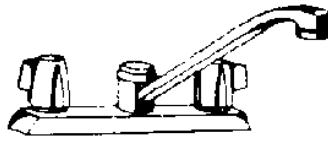

Delta 2 handle kitchen faucet

| FIG. NO. | PRICE |
|----------|-------|
| 38695 | |

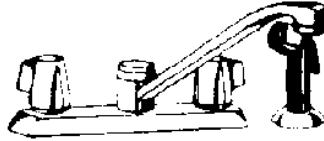

Delta 2 handle kitchen faucet with spray

| FIG. NO. | PRICE |
|----------|-------|
| 39078 | |

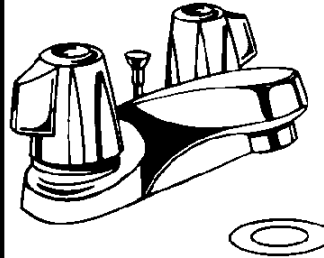

Delta 2 handle lav faucet, 4" centerset with pop-up

| FIG. NO. | PRICE |
|----------|-------|
| 40938 | |

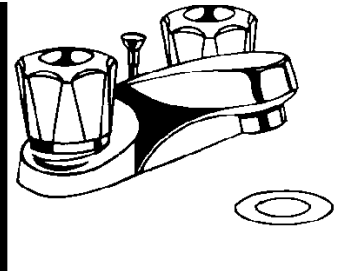

Delta 2 Acrylic handle lav faucet, 4" centerset with pop-up

| FIG. NO. | PRICE |
|----------|-------|
| 30098 | |

LAV

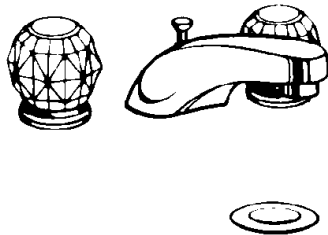

Delta 2 handle widespread lav faucet

| FIG. NO. | PRICE |
|----------|-------|
| 37960 | |

TWO HANDLE DECORATIVE LAV FAUCETS WITH HANDLE OPTIONS BY DELTA

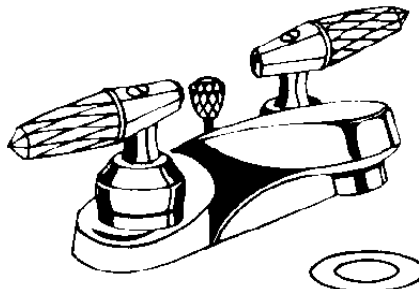

Faucet **LESS HANDLES**. Three hole installation. 4" centerset. **Handles sold separately. See chart below for handle options.**

| FIG. NO. | PRICE |
|----------|-------|
| 41492 | |

HANDLE OPTIONS

| DESCRIPTION | FIG. NO. | PRICE |
|--------------------------|----------|-------|
| Crystal (as shown above) | 41493 | |
| Oakwood | 41494 | |
| Rosewood | 41495 | |
| Porcelain | 41496 | |

BATH AND SHOWER

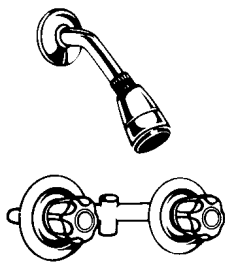

Delta 2 handle shower only

| FIG. NO. | PRICE |
|----------|-------|
| 39074 | |

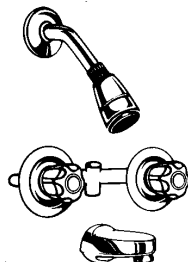

Delta 2 handle tub and shower

| FIG. NO. | PRICE |
|----------|-------|
| 39075 | |

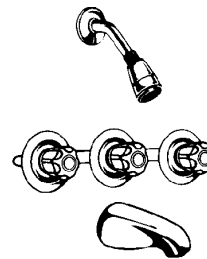

Delta 3 handle tub and shower

| FIG. NO. | PRICE |
|----------|-------|
| 33255 | |

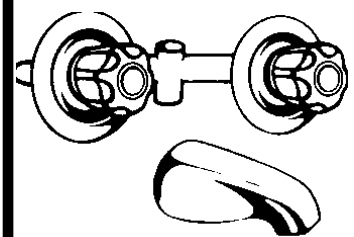

Delta 2 handle tub only

| FIG. NO. | PRICE |
|----------|-------|
| 79952 | |

FAUCETS BY DELTA

KITCHEN

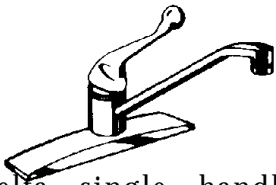

Delta single handle kitchen faucet. 8" center, 8" long spout swings 360°

| FIG. NO. | PRICE |
|----------|-------|
| 17745 | |

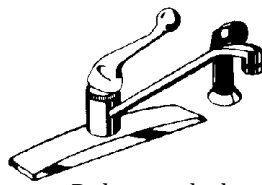

Delta single handle kitchen faucet. 4 hole installation, 8" center, 8" long spout swings 360°

| FIG. NO. | PRICE |
|----------|-------|
| 17746 | |

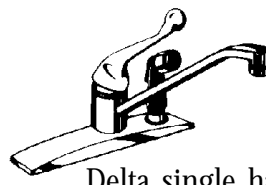

Delta single handle kitchen faucet. 3 hole installation, 8" center, 8" long spout swings 360°

| FIG. NO. | PRICE |
|----------|-------|
| 37982 | |

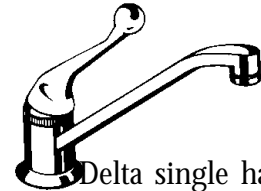

Delta single handle kitchen faucet. Single hole installation, 8" long spout swings 360° - lever handle

| FIG. NO. | PRICE |
|----------|-------|
| 51419 | |

LAVATORY

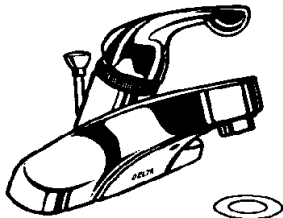

Delta single handle lav faucet. 3 hole installation, 4" center-set, lever handle with pop-up.

| FIG. NO. | PRICE |
|----------|-------|
| 30097 | |

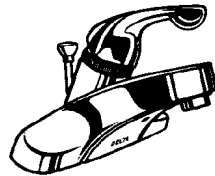

Delta single handle lav faucet. 2/3 hole installation, 4" center-set, lever hand with red blue indicators. Less pop-up.

| FIG. NO. | PRICE |
|----------|-------|
| 38082 | |

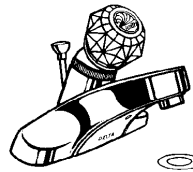

Delta single handle lav faucet. 3 hole installation, 4" center, clear knob handle with pop-up.

| FIG. NO. | PRICE |
|----------|-------|
| 17748 | |

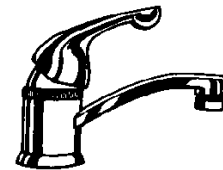

Delta single handle kitchen faucet. Single hole installation, 4" long spout swings 360° - lever handle

| FIG. NO. | PRICE |
|----------|-------|
| 30109 | |

TUB/SHOWER

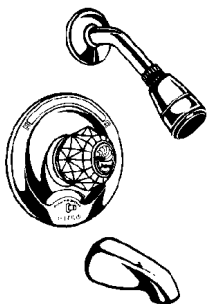

Delta single handle tub and shower, push button diverter, clear acrylic knob handle.

| FIG. NO. | PRICE |
|----------|-------|
| 30111 | |



Delta single handle tub and shower, lever handle with lift diverter spout.

| FIG. NO. | PRICE |
|----------|-------|
| 44708 | |



Delta single handle tub and shower, clear acrylic knob handle. Diverter spout.

| FIG. NO. | PRICE |
|----------|-------|
| 36304 | |



Delta single handle shower only.

| FIG. NO. | PRICE |
|----------|-------|
| 30112 | |

DELTA PARTS

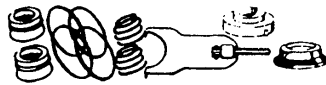

DELTA KIT - To repair all single lever faucets; lav, kitchen, tub & shower.

| FIG. NO. | PRICE |
|----------|-------|
| 15102 | |



DELTA O-RING - For single handle kitchen deck faucets manufactured since 1969 except pull-out spray models (blue dot O Ring only).

| FIG. NO. | PRICE |
|----------|-------|
| 44702 | |

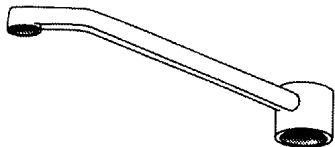

DELTA REPLACEMENT SPOUT - For Delta kitchen faucets, 8" length.

| FIG. NO. | PRICE |
|----------|-------|
| 33196 | |

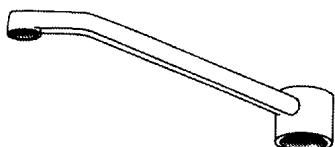

DELEX REPLACEMENT SPOUT - For Delta/Delex, 8" length.

| FIG. NO. | PRICE |
|----------|-------|
| 48469 | |

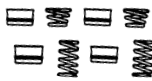

DELTA/DELEX SEATS & SPRING KIT - Contains 2 old style, 2 new style seats and springs, 8 pieces total.

| FIG. NO. | PRICE |
|----------|-------|
| 15103 | |

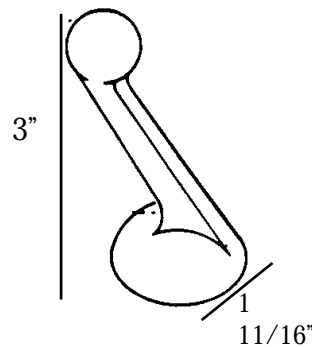

DELTA REPLACEMENT LEVER HANDLE
Lavatory, Bath

| FIG. NO. | PRICE |
|----------|-------|
| 47113 | |

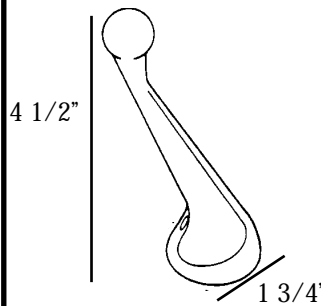

DELTA kitchen REPLACEMENT LEVER HANDLE

| FIG. NO. | PRICE |
|----------|-------|
| 33192 | |

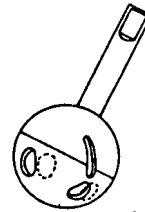

DELTA REPLACEMENT BALLS

| FIG. NO. | PRICE |
|-----------------|-------|
| Stainless 43671 | |
| Plastic 15105 | |
| Brass 58476 | |

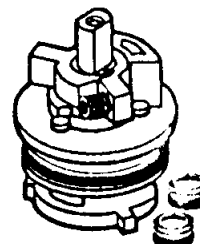

DELTA CARTRIDGE - For Delta Scaldguard tub & shower.

| FIG. NO. | PRICE |
|----------|-------|
| 48888 | |

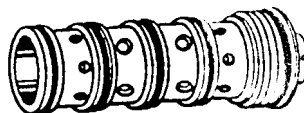

DELTA BALANCING SPOOL

| FIG. NO. | PRICE |
|----------|-------|
| 42517 | |

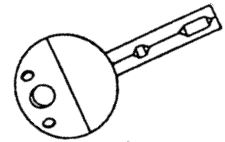

DELTA #212 "Diamond Ball"

| FIG. NO. | PRICE |
|----------|-------|
| 44700 | |

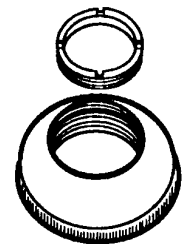

DELTA CAP AND RING KIT - CP Brass cap and adjusting ring to repair all single lever and knob faucets.

| FIG. NO. | PRICE |
|----------|-------|
| 33191 | |



ALL DELTA PARTS AVAILABLE IN BULK!

DELTA PARTS

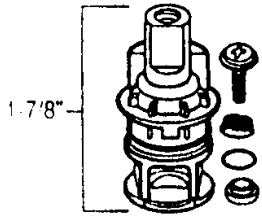

**DELTA DELEX
CARTRIDGE.**

| FIG. NO. | PRICE |
|----------|-------|
| 45432 | |

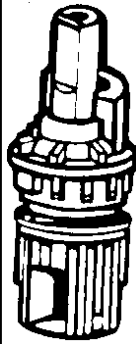

**DELTA STEM
UNIT - for two
handle and basin
faucets (except
slow close)**

| FIG. NO. | PRICE |
|----------|-------|
| 41838 | |



DELTA ADJUSTABLE RING:
For single handle faucets
(except 1300, 1400, 1500,
tub/shower series).

| FIG. NO. | PRICE |
|----------|-------|
| 37621 | |

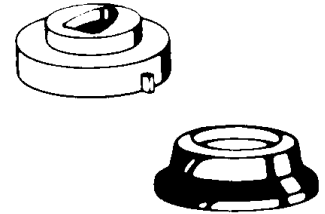

**DELTA CAM & PACKING -
for single lever handle faucets.**

| FIG. NO. | PRICE |
|----------|-------|
| 47114 | |

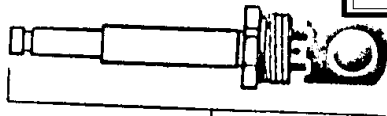

3-3/4"
**DELTA PUSH
BUTTON DIVERTER**

| FIG. NO. | PRICE |
|--------------|-------|
| 2-handle | 48471 |
| single lever | 33195 |



**ALSO REPLACES OLD
STYLE THAT LOOKS LIKE
THIS!**

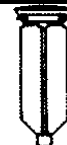

DELTA POP-UP PLUG

| FIG. NO. | PRICE |
|----------|-------|
| 39071 | |

**DELTA
DIVERTER
ASSEMBLY:**

For single handle kitchen
deck faucets.



| FIG. NO. | PRICE |
|----------|-------|
| 47992 | |



**DELTA
Soap/Lotion dispenser**

| FIG. NO. | PRICE |
|----------|-------|
| 42151 | |

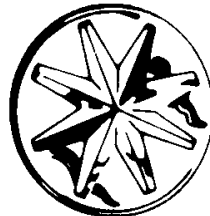

**DELTA
Chrome 3" cover**

| FIG. NO. | PRICE |
|----------|-------|
| 42699 | |

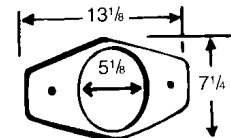

**DELTA SHOWER COVER-UP PLATE -
Covers up to 8" center holes**

| FIG. NO. | PRICE |
|----------|-------|
| 7856 | |

**DUFF IS ALWAYS
OPEN**

**365 DAYS A YEAR
24 HR EMERGENCY SERVICE!**

**DELTA SPRAY
'ROUND SWIVEL
AERATOR -
15/16" 27 male
thread or 55/64"
27 female thread.**



| FIG. NO. | PRICE |
|----------|-------|
| 37623 | |

ECONOMY FAUCETS



Rough Brass Laundry Tray
Faucet

| FIG. NO. | PRICE |
|----------|-------|
| 8147 | |

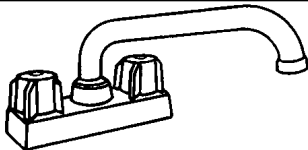

Chrome Plated Laundry Tray
Faucet

| FIG. NO. | PRICE |
|----------|-------|
| 14582 | |



8" Combination Wall
Faucet

| FIG. NO. | PRICE |
|----------|-------|
| 66137 | |

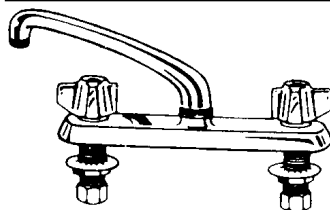

8" Deck Faucet

| FIG. NO. | PRICE |
|----------|-------|
| 14575 | |

Economy 4" Centerset with
Pop-Up

| FIG. NO. | PRICE |
|----------|-------|
| 14576 | |

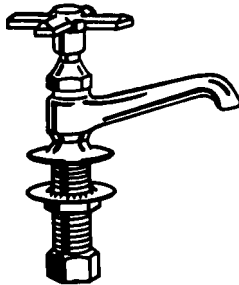

Economy Basin Cock

| FIG. NO. | PRICE |
|----------|-------|
| 19423 | |

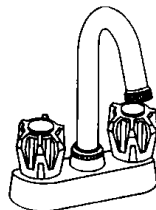

Economy 4" Bar Faucet

| FIG. NO. | PRICE |
|----------|-------|
| 14581 | |

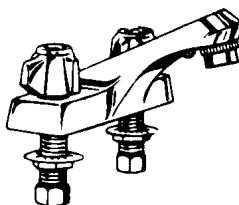

Economy 4" Centerset Less
Pop-Up

| FIG. NO. | PRICE |
|----------|-------|
| 14578 | |

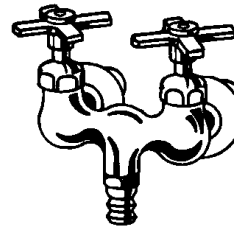
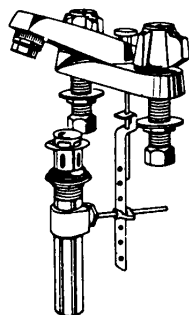

#3" Bath Cock

| FIG. NO. | PRICE |
|----------|-------|
| 8272 | |



Bath Offset Couplings
(PR) For #3 Bath Cock

| FIG. NO. | PRICE |
|----------|-------|
| 19787 | |

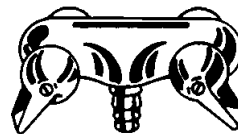

#0 Bath Cock

| FIG. NO. | PRICE |
|----------|-------|
| 8265 | |



Bath Faucet Coupling
Elbow (PR) For #0
Bath Cock

| FIG. NO. | PRICE |
|----------|-------|
| 19611 | |

Don't see what
you're looking
for?

Just Ask Us!!

WASHERLESS FAUCETS

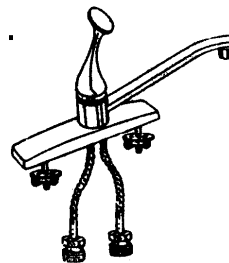

Economy Washerless
brass single lever
faucet. Chrome plated.
Energy efficient water
saver serator, brass ball.
Uses Delta Repair Kit!

| FIG. NO. | PRICE |
|----------|-------|
| 14575 | |

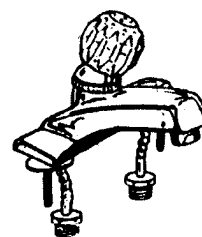

Economy Washerless
brass single lever 4"
center set basin/lav faucet.
Complete with corrugat-
ed riser with 1/2" IPS
adapters. Uses Delta
Repair Kit!

| FIG. NO. | PRICE |
|----------|-------|
| 14578 | |

COMMERCIAL SINK DRAINS

Lever Waste Installation Tool

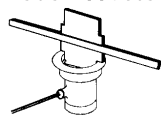

For removal or installation of any Franklin 1100 or 1200 series wastes with 3" or 3 1/2" openings.
Heavy Duty stainless steel construction

| FIG. NO. | PRICE |
|----------|-------|
| 38843 | |



DIPPER WELL FAUCET

2" Spout
1/2" NPS Shank
Chrome Plated Finish

| FIG. NO. | PRICE |
|----------|-------|
| 17623 | |



URN FAUCET

Chrome Plated Brass

| FIG. NO. | PRICE |
|----------|-------|
| 17630 | |

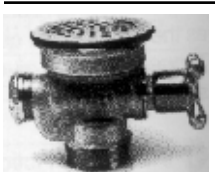

Fisher Rotary Waste Valve. Vandal resistant flat strainer, end cap, slip joint; chrome. Additional lever handle included.

| FIG. NO. | PRICE |
|----------|-------|
| 72441 | |

KITS ALSO AVAILABLE FOR FISHER, STANDARD-KEIL, KLEIN AND ELKAY

Waste Repair Kit

Contains common replacement parts for all Franklin Machine Products lever and twist wastes, component hardware group wastes and standard Keil wastes.

Contains 1 of each: 3" and 3 1/2" flange washers, body bushing, packing nut bushing, plunger o-ring, coupling nut washer, handle o-ring, twist handle snap rings, washer.

| FIG. NO. | PRICE |
|----------|-------|
| 18941 | |



Waste Repair Kit

Contains common replacement parts for all Franklin Machine Products OLD STYLE 3976 and 3979 series lever wastes. Contains 1 of each: flange washer, coupling nut washer, body bushing, packing nut bushing, o-ring.

| FIG. NO. | PRICE |
|----------|-------|
| 33950 | |



LEVER HANDLE WASTE with flat "snap-in" Stainless Steel strainer flange and handle.

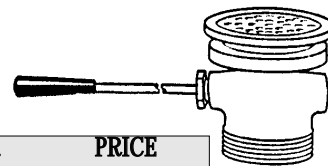

| DRAIN OUT-LET | SINK OPEN-ING | FIG. NO. | PRICE |
|---------------|---------------|----------|-------|
| 1 1/2" | 3" | 17624 | |
| 1 1/2" | 3 1/2" | 17626 | |
| 2" | 3" | 17627 | |
| 2" | 3 1/2" | 17628 | |

LEVER HANDLE WASTE FOR OVERFLOW with overflow outlets, "snap-in" Stainless Steel strainer flange and handle.

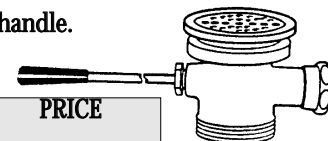

| DRAIN OUTLET | SINK OPENING | FIG. NO. | PRICE |
|--------------|--------------|----------|-------|
| 1 1/2" | 3" | 50873 | |
| 1 1/2" | 3 1/2" | 48513 | |
| 2" | 3" | 35844 | |
| 2" | 3 1/2" | 19016 | |

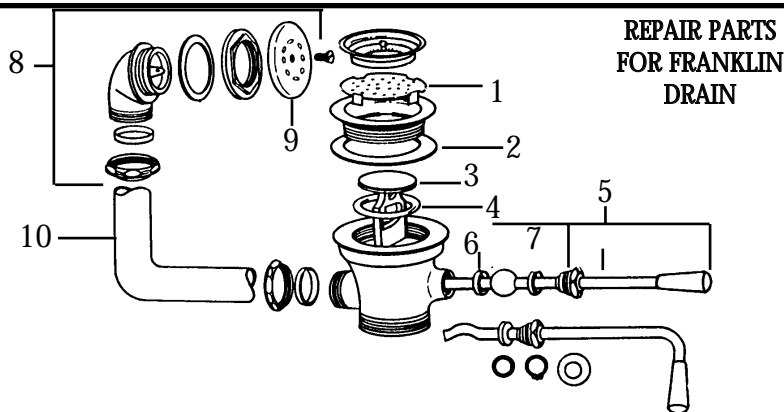

REPAIR PARTS FOR FRANKLIN DRAIN

| | DESCRIPTION | FIG. NO. | PRICE |
|----|--|----------|-------|
| 1 | Strainer - 3" Opening 3 1/8" Diameter | 18933 | |
| | Strainer - 3" Opening 3 7/16" Diameter | 18934 | |
| 2 | Washer - 3" sink opening | 18936 | |
| | Washer - 3 1/2" sink opening | 18937 | |
| 3 | Plunger with O-ring | 18932 | |
| 4 | O-Ring | 18931 | |
| 5 | Lever Rod | 18940 | |
| 6 | Body Bushing | 18939 | |
| 7 | Packing Nut Bushing | 48602 | |
| 8 | O overflow head assembly | 38795 | |
| 9 | Overflow strainer | 18927 | |
| 10 | Overflow elbow-1 1/4" OD x 14" X18" | 38796 | |

SLOAN FLUSH VALVES

CLOSET

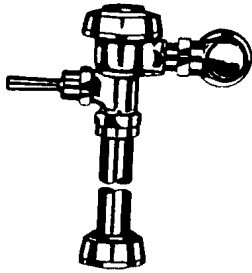

| MOD | GAL | FIG. NO. | PRICE |
|-----|-----|----------|-------|
| 110 | 1.5 | 47353 | |
| 110 | 3.5 | 7191 | |

URINAL

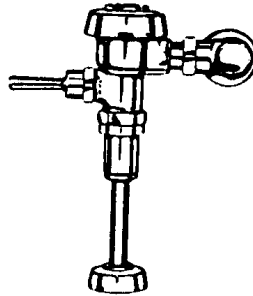

| MOD | GAL | FIG. NO. | PRICE |
|-----|-----|----------|-------|
| 180 | 1.5 | 7194 | |
| 186 | 3.0 | 7198 | |

BEDPAN WASHER

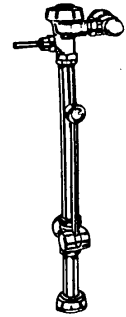

| FIG. NO. | PRICE |
|----------|-------|
| 20652 | |

CROWN/NAVAL

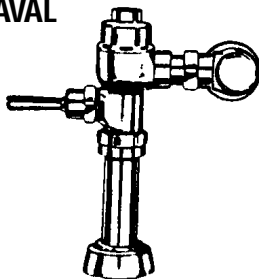

FACTORY ORDER

CROWN/DOLPHIN

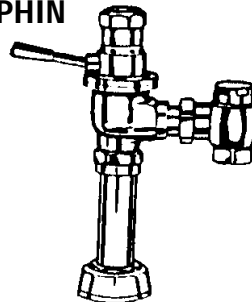

FACTORY ORDER

CONCEALED FLUSHVALVES

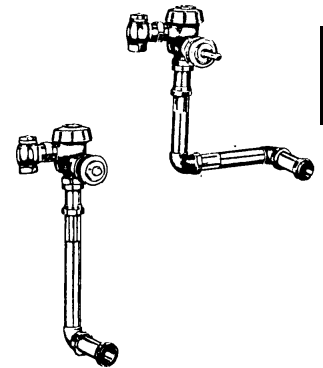

FACTORY ORDER

SERVICE SINK FLUSH VALVES

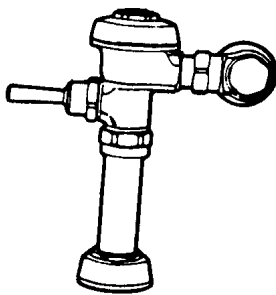

FACTORY ORDER

PENAL FLUSH VALVES

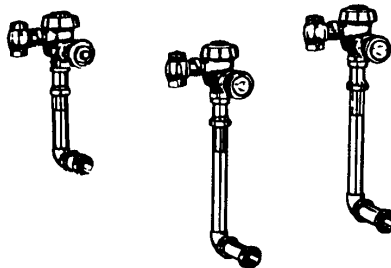

FACTORY ORDER

SLOAN HANDS FREE HAND DRYER

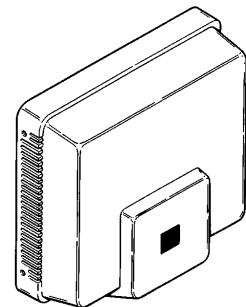

SENSOR OPERATED, 120V, HARD WIRE, 60 SECOND CUT-OFF SWITCH.

READY FOR IMMEDIATE SHIP-MENT!

OPTIMA

FLUSHVALVE

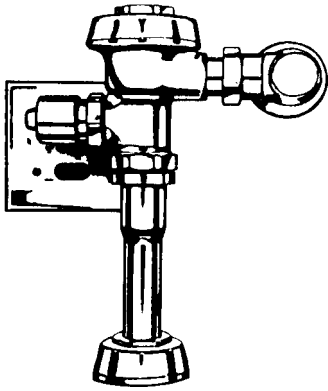

Complete with solenoid, sensor cover plate.

| SIZE | GAL | FIG. NO. | PRICE |
|-------|-----|----------|-------|
| 3/4 | 1.5 | 43205 | |
| 3/4 | 1.0 | | |
| 1 1/4 | 3.0 | 43204 | |
| 1 1/4 | 1.5 | | |
| 1 1/2 | 3.5 | 43200 | |
| 1 1/2 | 1.6 | | |

PLASTIC OPTIMA HEADS

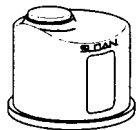
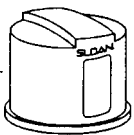

METAL OPTIMA HEAD

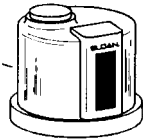
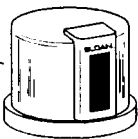

CALL FOR PRICING AND AVAILABILITY

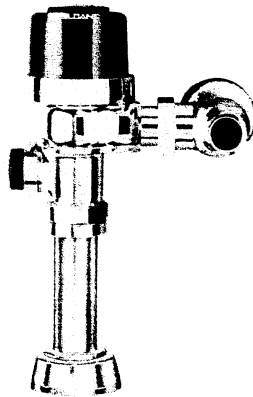

Complete left hand or right hand with optima battery powered infra red sensor. Battery life = 3 years. Sentinel flush 24 hours.

OPTIMA PLUS ELECTRICAL SPECIFICATIONS

Control Circuit: Solid state, 6V DC input, 8 sec. arming time, 3 sec flush delay.

Sensor Type: Active infra-red.

Sensor Range: 15" to 30" (adjustable +/- 8")

Battery Type: (4) AA Duracell Alkaline Model MN-1500

Battery Life: 3 years @ 4000 flush/month

Diagnostic Indicator Lights: Range adjustment/low batter.

Sentinel Flush: Once every 24 hours after last flush

| SIZE | GAL | FIG. NO. | PRICE |
|-------|-----------|----------|-------|
| 3/4 | 1.5urinal | 49404 | |
| 3/4 | 1.0urinal | | |
| 1 1/2 | 3.5closet | 49331 | |
| 1 1/2 | 1.6closet | | |

BATTERY OPERATED RETROFIT SENSOR

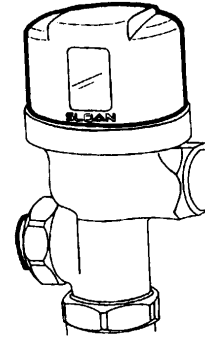

Transform your existing manually operated flushometer into a totally automatic flushing system in minutes. No hard wire electrical hookups or wall alterations are required because it is battery operated.

Battery life = 3 years

Sentinel flush = 24 hours

OPTIMA PLUS ELECTRICAL SPECIFICATIONS

Control Circuit: Solid state, 6V DC input, 8 sec. arming time, 3 sec flush delay.

Sensor Range: 15" to 30" (adjustable +/- 8")

Battery Type: (4) AA Duracell Alkaline Model MN-1500

Battery Life: 3 years @ 4000 flush/month

Diagnostic Indicator Lights: Range adjustment/low batter.

Sentinel Flush: Once every 24 hours after last flush

| FIG. NO. | PRICE |
|----------------|-------|
| 4.5 gal closet | 48541 |
| 3.5 gal closet | 47958 |
| 1.6 gal closet | 49648 |
| 3.0 gal urinal | 50605 |
| 1.5 gal urinal | 47959 |
| 1.0 urinal | |

SLOAN FLUSHOMETERS

ROYAL maintenance guide

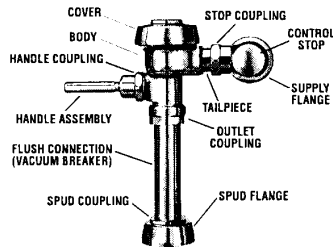

see chart on next page

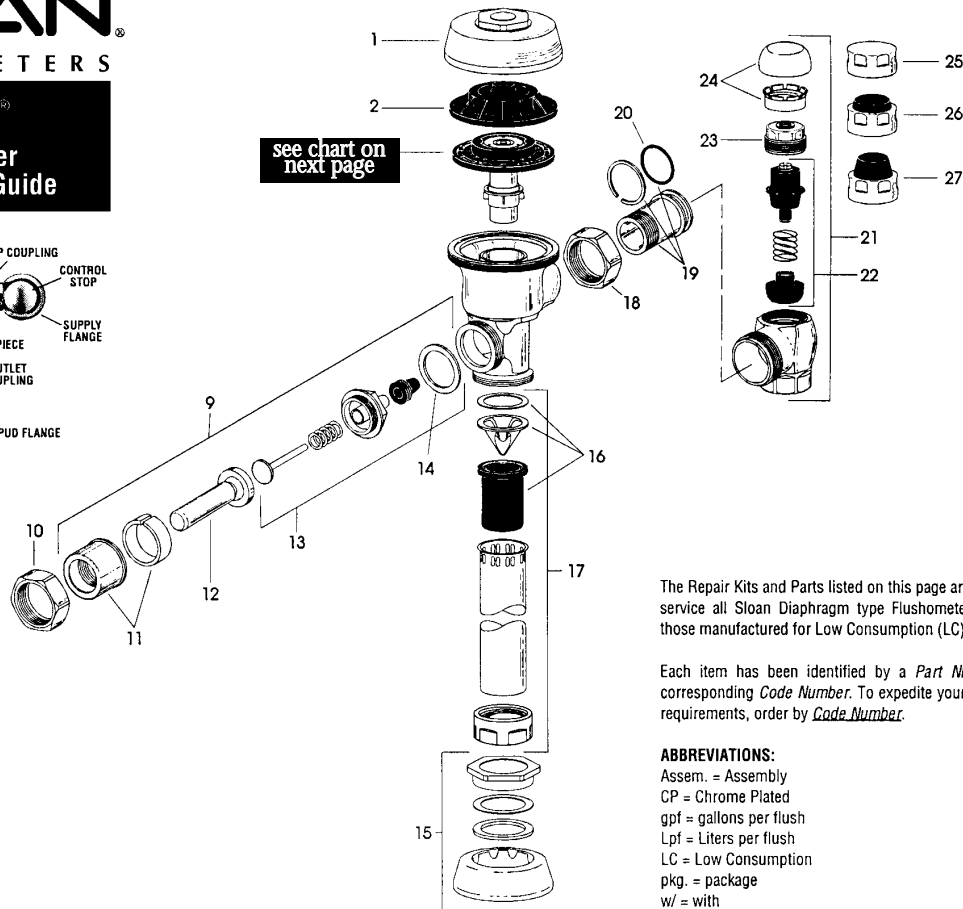

The Repair Kits and Parts listed on this page are designed to service all Sloan Diaphragm type Flushometers, including those manufactured for Low Consumption (LC) usage.

Each item has been identified by a Part Number and a corresponding Code Number. To expedite your replacement requirements, order by Code Number.

ABBREVIATIONS:
 Assem. = Assembly
 CP = Chrome Plated
 gpf = gallons per flush
 Lpf = Liters per flush
 LC = Low Consumption
 pkg. = package
 w/ = with

PARTS LIST

- 1. 0301172 **A-72** CP Cover
- 2. 0301168 **A-71** Inside Cover
- 3A. 5301058 **A-19-AC** Relief Valve, White (Closet) - 12 per pkg.
- 3B. 5301059 **A-19-AU** Relief Valve, Black (Urinal) - 12 per pkg.
- 3C. 5301211 **A-19-ALC** Relief Valve, Green (Closet/Urinal-LC) - 12 per pkg.
- 3D. 5301143 **A-19-AL** Relief Valve, Blue (9 Liter Closet) - 12 per pkg.
- 4. 5301111 **A-15-A** Disc - for all Inside Parts Kits - 12 per pkg.
- 5. 5301188 **A-156-A** Diaphragm - for all Inside Parts Kits - 12 per pkg.
- 6A. 5301236 **A-163-A** Guide Assem. 4.5 gpf/17.0 Lpf Closet & 1.5 gpf/5.7 Lpf Urinal - 12 per pkg.
- 6B. 5301032 **A-152-A** Guide Assem. 3.5 gpf/13.2 Lpf Closet - 12 per pkg.
- 6C. 5301031 **A-151-A** Guide Assem. 1.6 gpf/6.0 Lpf LC Closet - 12 per pkg.
- 6D. 5301155 **A-155-A** Guide Assem. 1.0 gpf/3.8 Lpf LC Urinal - 12 per pkg.
- 6E. 5301157 **A-157-A** Guide Assem. 0.5 gpf/1.9 Lpf Urinal - 12 per pkg.
- 7. **SEE THE INSIDE PARTS KITS CHART ON THE REVERSE SIDE**
- 9. 0302390 **B-73-A** CP Handicap Handle Assem. (A.D.A. Compliant) (shown)
- 5302279 **B-32-A** CP Handle Assem. (not shown) - 6 per pkg.
- 10. 0301082 **A-6** CP Handle Coupling
- 11. 0302109 **B-7-A** CP Socket Assem.
- 12. 0302389 **B-74-A** CP Handicap Handle Grip (A.D.A. Compliant) (shown)
- 5302274 **B-32** CP Handle Grip (not shown) - 12 per pkg.
- 13. 3302306 **B-51-A** Handle Repair Kit
- 14. 5301139 **A-31** Handle Gasket - 48 per pkg.
- 15. 0306125 **F-5-A** 3/4" CP Spud Coupling Assem.
- 0306140 **F-5-A** 1 1/4" CP Spud Coupling Assem.
- 0306146 **F-5-A** 1 1/2" CP Spud Coupling Assem.
- 16. 3323182 **V-651-A** Vacuum Breaker Repair Kit
- 17. 0393004 **V-600-AA** 3/4" x 9" CP Vacuum Breaker
- 0393006 **V-600-AA** 1 1/4" x 9" CP Vacuum Breaker
- 0393007 **V-600-AA** 1 1/2" x 9" CP Vacuum Breaker
- 18. 0308676 **H-550** CP Stop Coupling
- 19. 0308801 **H-551-A** CP Adjustable Tailpiece 2 1/16" long
- 20. 5308696 **H-553** "O" Ring - 24 per pkg.

- 21. 3308386 **H-700-A** 1" Screwdriver Bak-Chek® Stop CP - complete
- 3308384 **H-700-A** 3/4" Screwdriver Bak-Chek® Stop CP - complete
- 22. 3308853 **H-541-A** Control Stop Repair Kit*
- 3308856 **H-543-A** Control Stop Repair Kit**
- 23. 0308612 **H-622** CP Bonnet*
- 0308843 **H-577** CP Bonnet**
- 24. 3308791 **H-1010-A** Vandal Resistant Control Stop Cap Assem.*
- 3308790 **H-1009-A** Vandal Resistant Control Stop Cap Assem.**
- 25. 0308840 **H-573** Control Stop Cap CP*
- 0308848 **H-582** Control Stop Cap CP**
- 26. 3308866 **H-574** Control Stop Cap w/Bumper*
- 27. 3308867 **H-576** Control Stop Cap w/Extended Bumper*

* for use w/H-700-A 1" & 3/4" and H-600-A 1" Screwdriver Bak-Chek® Control Stops
 ** for use w/H-600-A 3/4" Screwdriver Bak-Chek® Control Stops

| MASTER FLUSHOMETER REBUILDING KITS | | |
|------------------------------------|----------|--|
| Includes Items 7-13-16 & 20 | | |
| CODE NO. | KIT NO. | DESCRIPTION |
| 3301048 | A-1001-A | Rebuild Kit (4.5 gpf/17.0 Lpf) Closet/Service Sink |
| 3301049 | A-1002-A | Rebuild Kit (1.5 gpf/5.7 Lpf) Urinal |
| 3301012 | A-1003-A | Rebuild Kit (3.5 gpf/13.2 Lpf) Closet |
| 3301013 | A-1004-A | Rebuild Kit (1.6 gpf/6.0 Lpf) LC Closet |
| 3301014 | A-1005-A | Rebuild Kit (1.0 gpf/3.8 Lpf) LC Urinal |
| 3301050 | A-1011-A | Rebuild Kit (0.5 gpf/1.9 Lpf) Urinal |
| 3301051 | A-1012-A | Rebuild Kit (2.4 gpf/9.0 Lpf) Closet |
| WASHER SET | | |
| 3301089 | A-156-AA | Washer Set - includes: 4, 5, 8 & 14 |

The information contained in this document is subject to change without notice.

For additional information call: 610-275-4453 or Fax: 610-279-6299
 Please call for current prices.

SLOAN FLUSHOMETERS

ROYAL maintenance guide

Troubleshooting and Maintaining the Sloan Royal® Flushometer

- 1. PROBLEM: Flushometer does not function.**
CAUSE: (a.) Control Stop or Main Valve is Closed.
 (b.) Handle Assembly is worn.
 (c.) Relief Valve is worn.
SOLUTION: (a.) Open Control Stop or Main Valve.
 (b.) Install Sloan Handle Repair Kit (B-51-A) or replace handle.
 (c.) Replace Inside Parts Kit.
- 2. PROBLEM: Insufficient volume of water to adequately siphon fixture.**
CAUSE: (a.) Control Stop not open enough.
 (b.) Urinal Flushometer Parts inside a Closet Flushometer.
 (c.) Low Consumption Flushometer installed on a non-Low Consumption fixture.
 (d.) Water Saver Kit installed in old, non-Water Saver bowl.
 (e.) Inadequate volume or pressure at supply.
SOLUTION: (a.) Adjust Control Stop for desired delivery of water.
 (b.) Replace Inside Urinal Parts with proper Closet Flushometer Parts.
 (c.) Replace A-41-A Inside Parts Kit with A-38-A Water Saver Kit.
 (d.) Position Refill Head A-170 so that SIDE 1 is in the UP Position.
 (e.) If no gauges are available to properly measure supply pressure or volume of water at the Flushometer, then remove the Relief Valve from the Inside Parts Kit, reassemble the Flushometer and open the Control Stop.
 • If the fixture siphons, more water volume is required. If a 3.5 gpf Inside Parts Kit is installed in the Flushometer, then first flip the Refill Head (under the Diaphragm) to obtain a 4.5 gpf volume. If this volume is still inadequate, remove the Flow Ring from the Guide to obtain a 6.5 gpf Kit. If additional flow is still required, try a Low Pressure Guide Kit A-175-A (#0301104). **IMPORTANT - Laws and Regulations requiring Low Consumption Fixtures (1.6 gpf Water Closets and 1.0 gpf Urinals) prohibit the use of higher flushing volumes.**
 • If fixture does not siphon or if a Low Consumption fixture is installed, or if the above steps do not prove satisfactory, steps must be taken to increase the pressure and/or supply.
- 3. PROBLEM: Flushometer closes off immediately.**
CAUSE: (a.) Ruptured or damaged Diaphragm.
 (b.) Enlarged By-pass orifice from corrosion or damage.
SOLUTION: Install Inside Parts Kit to correct above problems and update Flushometer.
- 4. PROBLEM: Length of flush is too short (Short Flushing).**
CAUSE: (a.) Diaphragm Assembly and Guide Assembly are not hand-tight.
 (b.) Enlarged By-pass orifice from corrosion or damage.
 (c.) A-19-AU (Black) Urinal Relief Valve in Closet Flushometer.
 (d.) A-41-A Low Consumption Kit installed in non-Low Consumption fixture.
 (e.) Handle Assembly is worn.
SOLUTION: (a.) Screw the two assemblies hand-tight.

- (b.) Install NEW Inside Parts Kit to correct problem and update Flushometer.
 (c.) Replace Relief Valve with A-19-AC (White) Closet Relief Valve.
 (d.) Replace with proper Inside Parts Kit.
 (e.) Install Handle Repair Kit B-51-A or replace the Handle.

- 5. PROBLEM: Length of flush is too long (Long Flushing) or fails to close off.**
CAUSE: (a.) Relief Valve (A-19-A) is not seating properly or By-pass orifice is clogged because of foreign material, or By-pass orifice is closed by an invisible gelatinous film from "over-treated" water.
 (b.) Line pressure has dropped and is not sufficient to force Relief Valve to seat.
 (c.) A-19-AC (White) Closet Relief Valve has been used in a 1 or 1 1/2 gpf Urinal.
 (d.) Inside Cover is cracked or damaged.
SOLUTION: (a.) Disassemble the working parts and wash thoroughly. **NOTE: SIZE OF THE ORIFICE IN THE BY-PASS IS OF UTMOST IMPORTANCE FOR THE PROPER METERING OF WATER INTO THE UPPER CHAMBER OF THE FLUSHOMETER. DO NOT ENLARGE OR DAMAGE THIS ORIFICE. REPLACE INSIDE KIT IF CLEANING DOES NOT CORRECT PROBLEM.**
 (b.) Shut off all control stops until pressure has been restored, then open them again.
 (c.) Replace with A-19-AU (Black) Relief Valve.
 (d.) Replace the Inside Cover (A-71).

- 6. PROBLEM: Chattering noise in Flushometer.**
CAUSE: (a.) The A-156-A Segment Diaphragm has been installed upside-down.
 (b.) The Inside Cover has become distorted from wear, freezing or abuse.
SOLUTION: (a.) Replace the Segment Diaphragm to the proper position as instructed by markings on the Diaphragm.
 (b.) Replace Inside Cover.

- 7. PROBLEM: Leaking at Handle Assembly.**
CAUSE: (a.) The B-39 Seal is worn or deteriorated.
 (b.) Handle gasket has been omitted.
 (c.) Valve Handle Bushing is worn.
SOLUTION: (a.) Install new B-39 Seal. **NOTE: The B-39 Seal will easily slide right onto the B-40 Bushing if it is wet.**
 (b.) Install A-31 Handle Gasket or Sloan Handle Repair Kit (B-51-A).
 (c.) Install Sloan Handle Repair Kit (B-51-A).

CARE AND CLEANING INSTRUCTIONS

DO NOT use abrasive or chemical cleaners to clean Flushometers, they may dull the luster and attack the chrome or special decorative finishes. Use ONLY soap and water, then wipe dry with a clean towel or cloth. While cleaning the bathroom tile, the Flushometer should be protected from any splattering of cleaner. Acids and cleaning fluids can discolor or remove chrome plating. If further assistance is required, please contact the Sloan Valve Company Installation Engineering Dept. 847/671-4300.

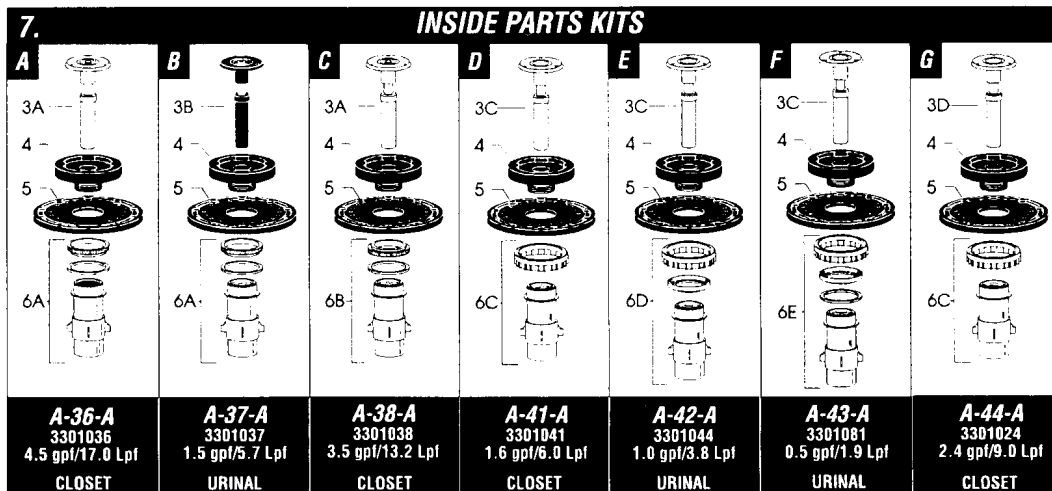

SLOAN FLUSHOMETERS

REGAL maintenance guide

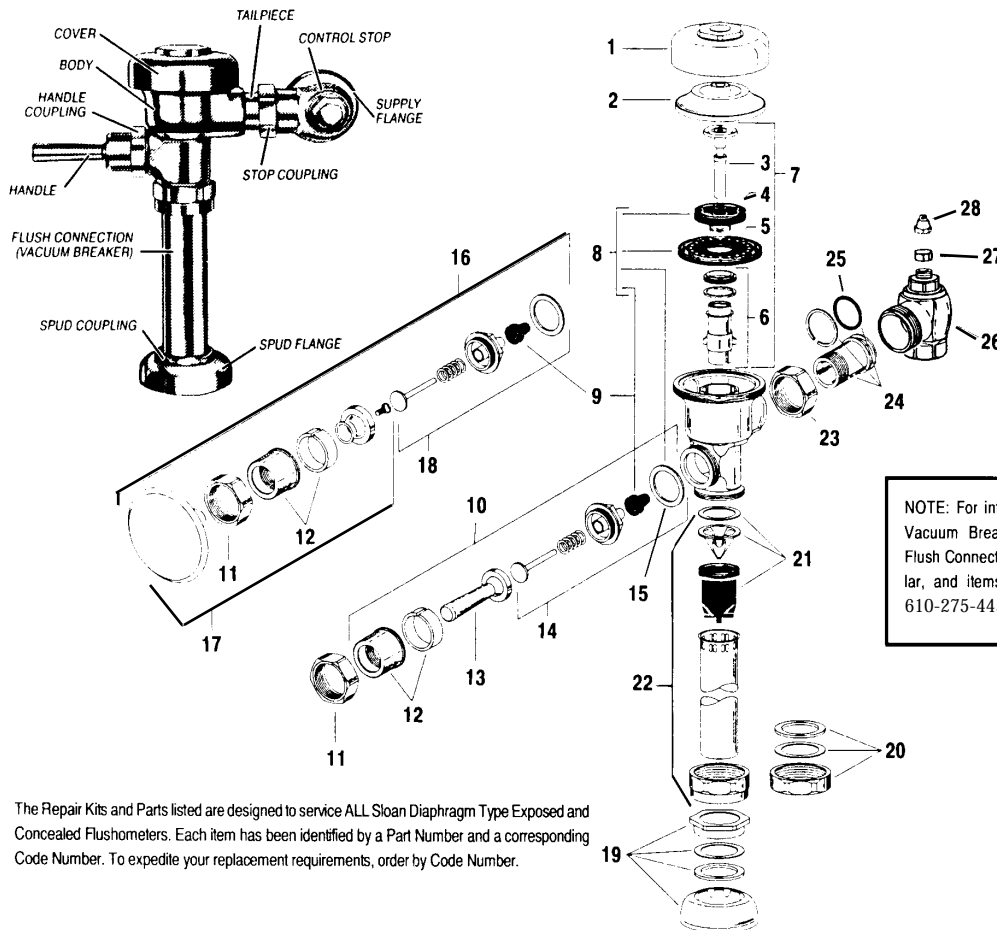

NOTE: For information on V-500-A, V-500-AA Vacuum Breakers, Exposed and Concealed Flush Connections, Tailpieces longer than regular, and items not shown call DUFF CO at 610-275-4453.

The Repair Kits and Parts listed are designed to service ALL Sloan Diaphragm Type Exposed and Concealed Flushometers. Each item has been identified by a Part Number and a corresponding Code Number. To expedite your replacement requirements, order by Code Number.

PARTS LIST

| | | | | | | | |
|-----|---------|----------|---|-----|---------|----------|---|
| 1. | 0317004 | R-10 | CP Cover* | 17. | 3303347 | C-1000-A | 3" CP Push Button Replacement Kit |
| 2. | 0301168 | A-71 | Inside Cover | 18. | 3303396 | C-64-A | 3" Push Button Repair Kit |
| 3. | 5301058 | A-19-AC | Relief Valve, White(Closet) - 12 per pkg. | 19. | 0306145 | F-56-A | 1 1/2" CP Spud Coupling |
| | 5301059 | A-19-AU | Relief Valve, Black (Urinal) - 12 per pkg. | | 0306142 | F-55-A | 1 1/4" CP Spud Coupling |
| 4. | 5301111 | A-15-A | Disc - 12 per pkg. | | 0306102 | F-54-A | 3/4" CP Spud Coupling |
| 5. | 5301188 | A-156-A | Diaphragm - 12 per pkg. | 20. | 0306093 | F-2-A | 1 1/2" CP Outlet Coupling Assembly* |
| 6. | 5301236 | A-163-A | Guide - 12 per pkg. | 21. | 3323192 | V-551-A | Vacuum Breaker Repair Kit |
| | 5301031 | A-151-A | Guide (1.6 GPF) Low Consumption Closets - 12 per pkg. | 22. | 5323005 | V-500-AA | 3/4" x 9" Vacuum Breaker |
| 7. | 3301036 | A-36-A | Inside Parts Kit (4 1/2 GPF) Standard Closets /Service Sinks | | 5323006 | V-500-AA | 1 1/4" x 9" Vacuum Breaker |
| | 3301037 | A-37-A | Inside Parts Kit (1 1/2 GPF) Washdown/Water Saver Urinals | | 5323007 | V-500-AA | 1 1/2" x 9" Vacuum Breaker |
| | 3301038 | A-38-A | Inside Parts Kit (3 1/2 GPF) Water Saver Closets/3 gal. Urinals | 23. | 0308676 | H-550 | CP Stop Coupling* |
| | 3301041 | A-41-A | Inside Parts Kit (1.6 GPF) for Low Consumption Closets | 24. | 0308801 | H-551-A | CP Adjustable Tailpiece 2 1/16" long* |
| | 3301042 | A-42-A | Inside Parts Kit (1 GPF) for Low Consumption Urinals | 25. | 5308696 | H-533 | *O'Ring - 24 per pkg. |
| 8. | 5301189 | A-156-AA | Closet/Urinal Washer Set - 6 per pkg. | 26. | 0308704 | H-540-A | 1" Screwdriver Bak-Chek CP Control Stop |
| 9. | 5302297 | B-39 | Seal-12 per pkg. | | 3308853 | H-541-A | 1" Screwdriver Bak-Chek Repair Kit |
| 10. | 5302279 | B-32-A | CP Handle Assembly - 6 per pkg. | | 0308727 | H-540-A | 3/4" Screwdriver Bak-Chek CP Control Stop |
| | 0302390 | B-73-A | CP Handicapp Handle Assembly | | 3308856 | H-543-A | 3/4" Screwdriver Bak-Chek Repair Kit |
| 11. | 0301082 | A-6 | CP Handle Coupling* | 27. | 5308156 | H-37 | CP Cap - 6 per pkg. |
| 12. | 0302109 | B-7-A | CP Socket | 28. | 5310034 | J-2/J-7 | Bumper Assembly - 12 per pkg. |
| 13. | 5302274 | B-32 | CP Grip - 12 per pkg. | | | | |
| 14. | 5302305 | B-50-A | Handle Repair Kit - 6 per pkg. | | | | |
| 15. | 5301139 | A-31 | Handle Gasket - 48 per pkg. | | | | |
| 16. | 0303351 | C-42-A | 3" CP Push Button Assembly | | | | |

CALL US NOW FOR YOUR SPECIAL PRICING!

For additional information call: 610-275-4453 or Fax: 610-279-6299
Please call for current prices.

SLOAN FLUSHOMETERS (cont'd)

OPTIMA PLUS maintenance guide

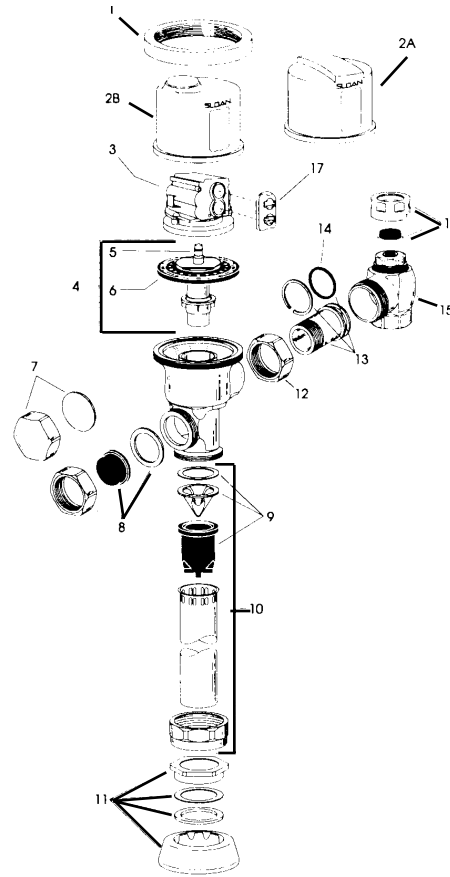
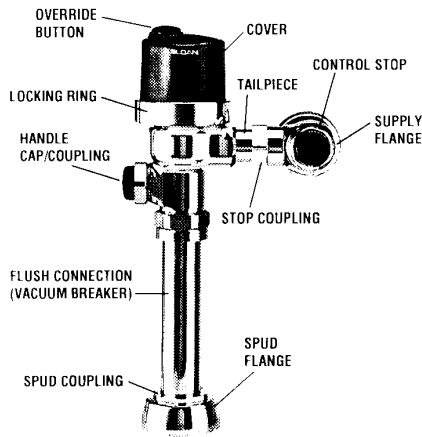

PARTS LIST

| | | | | | | | |
|-----|---------|--------------|---|---------|---------|------------------------|---|
| 1. | 0305804 | EBV-14 | CP Locking Ring | 0306140 | F-5-A | 1 1/4 CP Spud Coupling | |
| | 3305524 | EBV-31-A | CP Locking Ring for ZURN Valve Bodies | 0306146 | F-5-A | 3/4 CP Spud Coupling | |
| 2A. | 0305806 | EBV-11 | Cover | 12. | 0308676 | H-550 | CP Stop Coupling |
| 2B. | 3305538 | EBV-38-A | Cover w/Override Button | 13. | 0308801 | H-551-A | CP Adjustable Tailpiece 2 1/4" long |
| 3. | 3305540 | EBV-26-AU1 | Electronic Module - 1 gpf/3.8 lpf (Urinal) | 14. | 5308696 | H-553 | "O" Ring - 24 per pkg. |
| | 3305541 | EBV-26-AU1.5 | Electronic Module - 1.5 gpf/5.7 lpf (Urinal) | 15. | 0308757 | H-600-A | CP 1" Screwdriver Bak-Chek Control Stop |
| | 3305543 | EBV-26-AU3.0 | Electronic Module - 3 gpf/11.4 lpf (Urinal) | | 0308724 | H-600-A | CP 3/4" Screwdriver Bak-Chek Control Stop |
| | 3305542 | EBV-26-AC1.6 | Electronic Module - 1.6 gpf/6 lpf (Closet) | 16. | 3305816 | EBV-1019-A | 3/4" Decorative Stop Cap |
| | 3305544 | EBV-26-AC3.5 | Electronic Module - 3.5 & 4.5 gpf/13.3 & 17 lpf (Closet) | | 3308866 | H-574 | 1" Decorative Stop Cap |
| 4. | 3305851 | EBV-32-A-1.0 | Inside Parts Assembly - 1 gpf/3.8 lpf (Urinal) | | | | |
| | 3305818 | EBV-32-A-1.5 | Inside Parts Assembly - 1.5 gpf/5.7 lpg (Urinal) | | | | |
| | 3305850 | EBV-10A-1.6 | Inside Parts Assembly - 1.6 gpf/6 lpf (Closet) | | | | |
| | 3305841 | EBV-10A-3.0 | Inside Parts Assembly - 3 gpf/11.4 lpf (Urinal) & 3.5 gpf/13.3 lpf (Closet) | | | | |
| | 3305842 | EBV-10A-4.5 | Inside Parts Assembly - 4.5 gpf/17 lpf (Closet) | | | | |
| 5. | 5305813 | EBV-18 | Quad Ring - 12 per pkg. | | | | |
| 6. | 5301188 | A-156-A | Diaphragm - 12 per pkg. | | | | |
| 7. | 3305814 | EBV-1017-A | Handle Cap - Solid | 17. | 3305537 | EBV-46-A | Beam Deflector |
| 8. | 3305815 | EBV-1018-A | Handle Cap - Decorative | | | | |
| 9. | 3323192 | V-551-A | Vacuum Breaker Repair Kit | | | | |
| 10. | 5323005 | V-500-A | 3/4 x 9 Vacuum Breaker - 6 per pkg. | | | | |
| | 5323006 | V-500-A | 1 1/4 x 9 Vacuum Breaker - 6 per pkg. | | | | |
| | 5323007 | V-500-A | 1 1/2 x 9 Vacuum Breaker - 6 per pkg. | | | | |
| 11. | 0306125 | F-5-A | 1 1/2 CP Spud Coupling | | | | |

Accessories

17. 3305537 EBV-46-A Beam Deflector

Stop Repair Kits

3308853 H-541-A 1" Screwdriver Stop Repair Kit
3308856 H-543-A 3/4" Screwdriver Stop Repair Kit

Batteries: When required, replace batteries with four (4) Duracell Alkaline AA (Model MN-1500) batteries. Replacement batteries *NOT* available from Sloan.

CALL US NOW FOR YOUR SPECIAL PRICING!

SLOAN BEDPAN REPAIR KIT

SLOAN
FLUSHOMETERS

slimline®
Bedpan Washer
Maintenance Guide

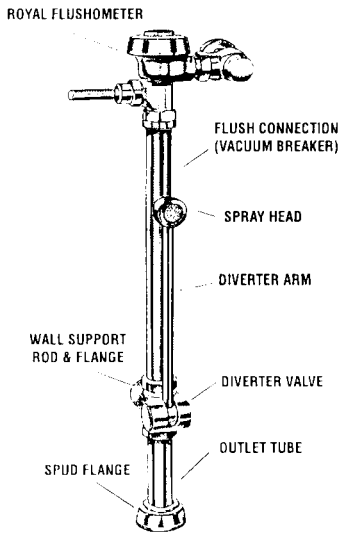

See Royal Flushometer Troubleshooting and Maintenance Guide for ALL Valve Kits and Components.

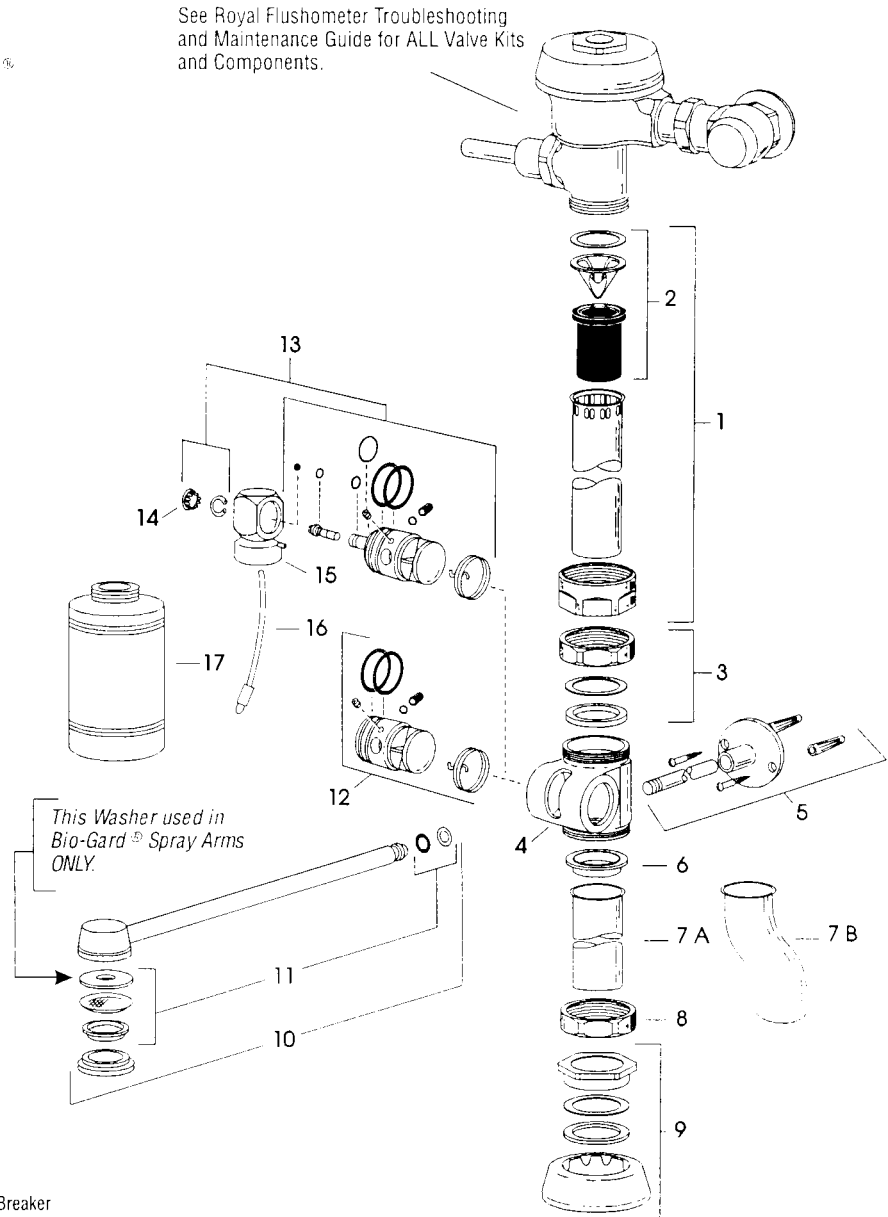

PARTS LIST

- 1. 0393009 V-600-AA 1 1/2" X 21 1/2" Vacuum Breaker
- 0393008 V-600-AA 1 1/2" x 13 1/2" Vacuum Breaker (ADA height)
- 0393029 V-600-AA 1 1/2" x 21 1/2" Vacuum Breaker w/2" Offset
- 2. 3323182 V-651-A Vacuum Breaker Repair Kit
- 3. 0306093 F-2-A 1 1/2" Slip Joint Coupling
- 4. 0309001 DV-1 Diverter Valve Body
- 5. 3309035 DV-1001-A Wall Support Kit
- 6. 0309027 F-1003 Outlet Tube Gasket
- 7A. 0309029 F-1005 Outlet Tube
- 7B. 0396525 F-182 Outlet Tube w/1 1/2" Offset
- 8. 0306045 F-2 1 1/2" Coupling Nut
- 9. 0306146 F-5-A 1 1/2" Spud Coupling Assembly
- 10. 3309044 DV-32-AA Spray Arm Replacement Kit
- 3309016 DV-1013-A Bio-Gard Spray Arm Replacement Kit
- 3309077 DV-1014-A Short Spray Arm Replacement Kit (for use w/F-182 Offset Outlet Tube)
- 11. 3309032 DV-1007-A Spray Arm Repair Kit
- 12. 3309037 DV-1003-A Pivot Replacement Kit
- 13. 3309036 DV-1002-A Deoseptic Pivot Replacement Kit
- 14. 0309024 DV-21 Plug Button
- 15. 0309033 DV-33-A Swivel & Ball Check Assembly
- 16. 0309036 DV-36-A Aspirator Tube Assembly
- 17. 0309018 DV-29 Deoseptic Solution Bottle

BEDPAN WASHER REBUILD KITS

| CODE # | KIT # | DESCRIPTION |
|---------|-----------|---|
| 5309031 | DV-50-A | DIVERTER REBUILD KIT Includes outlet tube gasket (item 6), spray arm repair kit (item 11), and all items in pivot replacement kit (item 12) except pivot. |
| 3309040 | DV-1004-A | DEOSEPTIC DIVERTER REBUILD KIT Includes outlet tube gasket (item 6), spray arm repair kit (item 11), and all items in pivot replacement kit (item 13) except pivot. |

To convert a standard diverter assembly to a deoseptic diverter assembly use:
3309048 DV-1005-A DEOSEPTIC CONVERSION KIT

SLOAN REPAIR

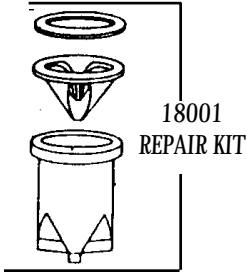

**SLOAN
VACUUM
BREAKER**

| DESCR | FIG. NO. | PRICE |
|--|----------|-------|
| V500A complete vacuum breaker repair kit | 7263 | |
| V551A repair kit | 18001 | |

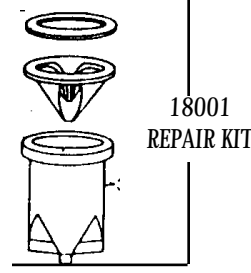

**SLOAN
VACUUM
BREAKER**

| DESCR | FIG. NO. | PRICE |
|--------------------------|----------|-------|
| 3/4x9 CP Vac Brkr | 38130 | |
| 1x9 CP Vac Brkr | 7256 | |
| 1-1/4x9 CP Vac Brkr | 7259 | |
| 1-1/4x21-1/2 CP Vac Brkr | 44763 | |
| 1-1/2x9 CP Vac Brkr | 7261 | |
| 1-1/2x13-1/2 CP Vac Brkr | 44627 | |
| 1-1/2x24-1/2 CP Vac Brkr | 38133 | |
| V553A CP Cplg | 38134 | |
| V551A repair kit | 18001 | |

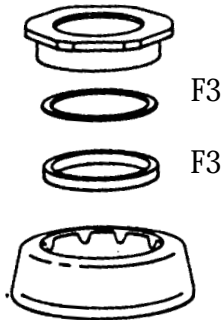

**SPUD COUPLING
ASSEMBLY**

| SIZE | FIG. NO. | PRICE |
|--------|----------|-------|
| 3/4" | 7224 | |
| 1" | 7225 | |
| 1 1/4" | 7226 | |
| 1 1/2" | 7228 | |

FRICTION RING ONLY

| SIZE | FIG. NO. | PRICE |
|--------|----------|-------|
| 3/4" | 28176 | |
| 1 1/4" | 38114 | |
| 1 1/2" | 38115 | |

SLIP JOINT GASKET ONLY

| SIZE | FIG. NO. | PRICE |
|--------|----------|-------|
| 3/4" | 24620 | |
| 1 1/4" | 38128 | |
| 1 1/2" | 38127 | |

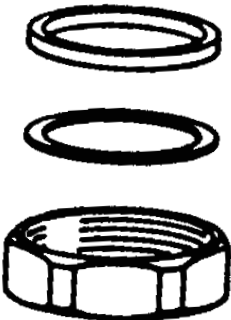

**F2A COUPLING
ASSEMBLY**

| SIZE | FIG. NO. | PRICE |
|--------|----------|-------|
| 3/4" | 7216 | |
| 1 1/2" | 7222 | |

SWEAT KIT

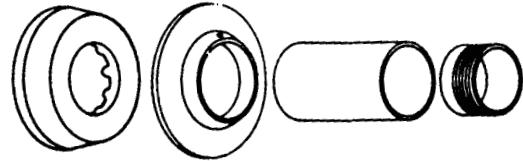

| DESCR | FIG. NO. | PRICE |
|-------|----------|-------|
| 1" | 7204 | |
| 3/4" | 7206 | |

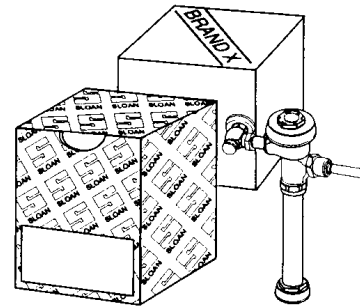

**GENUINE SLOAN PARTS
VS. NO NAME PARTS.
IT'S NO CONTEST.**

**ALL GENUINE SLOAN
PARTS AVAILABLE IN BULK!**

SLOAN REPAIRS

INTERNAL REPAIR KIT

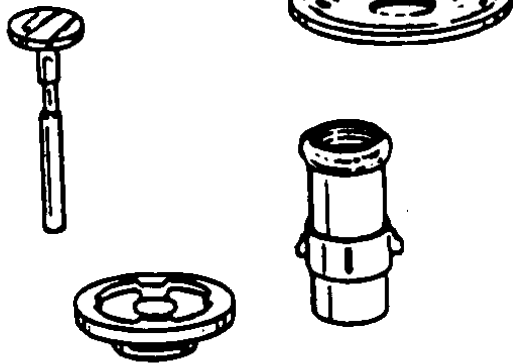

| OEM | DESCR | FIG. NO. | PRICE |
|--------|---------------------|----------|-------|
| A36A | Closet Kit 4.5 Gal | 7273 | |
| A37A | Urinal Kit 1.5 Gal | 7274 | |
| A38A | Closet Kit 3.5 Gal | 7275 | |
| A41A | Closet Kit 1.6 Gal | 50131 | |
| A42A | Urinal Kit 1.0 Gal | | |
| A15A | Disc | 7210 | |
| A156A | Diaphragm | 7277 | |
| A156AA | Diaphragm Kit | 38660 | |
| A163A | Guide | 38661 | |
| A19AC | Closet Relief Valve | 7207 | |
| A19AU | Urinal Relief Valve | 38655 | |

HANDLE REPAIR KIT

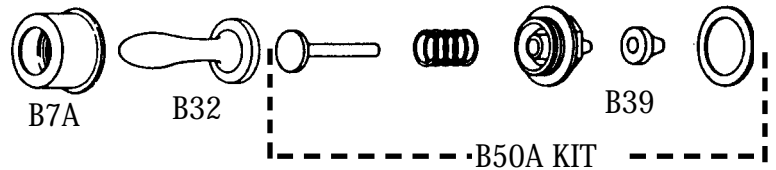

| OEM | DESCR | FIG. NO. | PRICE |
|------|--------|----------|-------|
| B32A | Kit | 32820 | |
| B50A | Kit | 7282 | |
| B32 | Handle | 38662 | |
| B39 | Seal | 7280 | |
| B7A | Socket | 7214 | |

PEDAL PUSH BUTTON FOR EXPOSED ROYAL & CROWN HANDLE REPAIR KIT

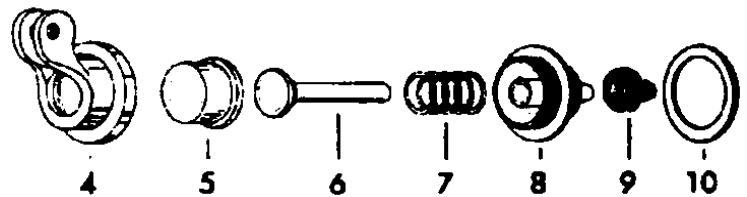

| FIG. NO. | PRICE |
|----------|-------|
| 7281 | |

SLOAN PISTON KIT

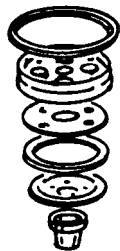

| DESCR | FIG. NO. | PRICE |
|----------------|----------|-------|
| Replaces S14AA | 38126 | |



CAPS FOR SLOAN - chrome plated



| DESCR | FIG. NO. | PRICE |
|---------------|----------|-------|
| Replaces H582 | 7245 | |
| Replaces H573 | 7244 | |

VANDAL PROOF CAP FOR SLOAN



| SIZE | FIG. NO. | PRICE |
|------|----------|-------|
| 3/4" | 38948 | |
| 1" | 38947 | |

SLOAN INSIDE PLASTIC COVER (NEW STYLE)



| DESCR | FIG. NO. | PRICE |
|---------|----------|-------|
| A71 | 7212 | |
| 0306668 | | |

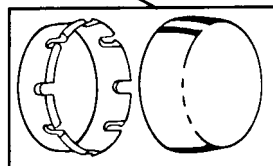
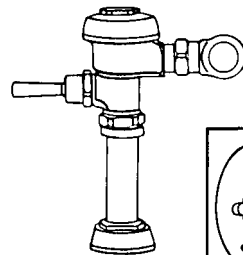

SLOAN VANDAL-RESISTANT CONTROL STOP CAP

New stop cap retrofits on your existing control stop (600 Series). No-hex design gives you Sloan Flushometers a contemporary styling, while eliminating the flats and leverage of the old design. All-metal new control stop cap installs quick and easy. After installation, it spins freely, further helping to eliminate leverage and vandalism. Brass construction provides long life and durability while protecting the screwdriver slotted regulating stem from unauthorized tampering.

| SIZE | OEM FIG. NO. | PRICE |
|------|----------------|-------|
| 3/4" | H-1009-A 78881 | |
| 1" | H-1010-A 78882 | |

SLOAN STOP REPAIR KITS

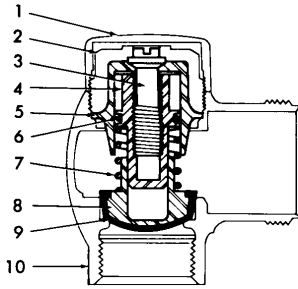

| DESCRIPTION | FIG. NO. | PRICE |
|--|----------|-------|
| Repair kit for H600A, H600AG, H-540A, H540AG 1" screw driver control stop includes items 3-9 | 7288 | |
| H600A complete valve 3/4" | 7232 | |
| H600A complete valve 1" | 7233 | |

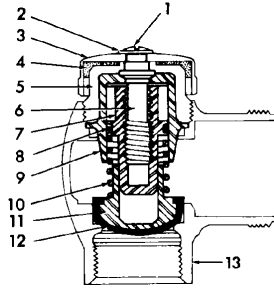

| DESCRIPTION | FIG. NO. | PRICE |
|---|----------|-------|
| Repair kit for H600A, H600AG, H-540A, H540AG 1" wheel handle control stop includes items 6-13 | 7289 | |

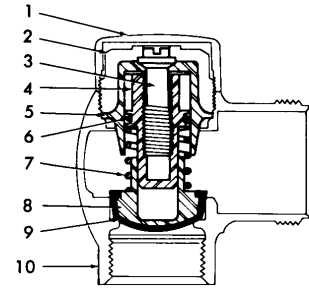

| DESCRIPTION | FIG. NO. | PRICE |
|--|----------|-------|
| Repair kit for H600A, H600AG, H-540A, H540AG 3/4" screw driver control stop includes items 3-9 | 7290 | |

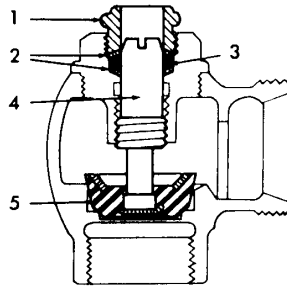

| DESCRIPTION | FIG. NO. | PRICE |
|---|----------|-------|
| H440AG 1" screw driver angle stop kit. Includes 1-5 | 21184 | |

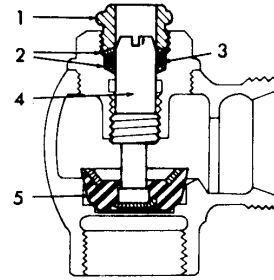

| DESCRIPTION | FIG. NO. | PRICE |
|---|----------|-------|
| H440AG 3/4" screw driver angle stop kit. Includes 1-5 | 38121 | |

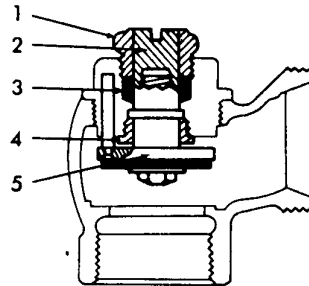

| DESCRIPTION | FIG. NO. | PRICE |
|--|----------|-------|
| H440AG 1" & 3/4" screw driver angle stop kit. Includes 1-5 | 25981 | |

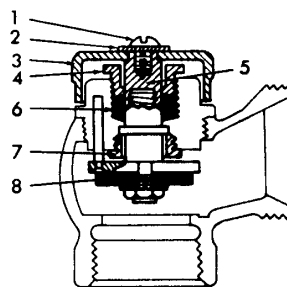

| DESCRIPTION | FIG. NO. | PRICE |
|--|----------|-------|
| H440 1" & 3/4" wheel handle angle stop kit. Includes 1-8 | 20677 | |

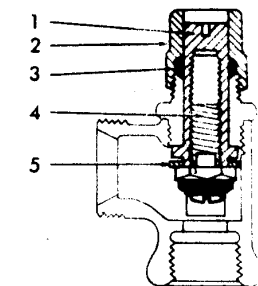

| DESCRIPTION | FIG. NO. | PRICE |
|---|----------|-------|
| H20AG 3/4" & 1/2" screw driver angle stop kit. Includes 1-5 | 38119 | |

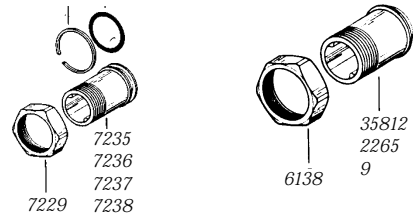

| DESCRIPTION | FIG. NO. | PRICE |
|-----------------------------------|----------|-------|
| H550 CP cplg f/adj tail | 7229 | |
| H551A CP 2-1/16 adj tail assembly | 7235 | |
| H551A CP 3-1/16 adj tail assembly | 7236 | |
| H551A CP 4-1/16 adj tail assembly | 7237 | |
| H551A CP 5-1/16 adj tail assembly | 7238 | |
| H6 CP cplg f/ GJ tail | 73457 | |
| H5 CP 1-1/4 GJ tail | 35812 | |
| H5 CP 1-1/2 GJ tail | 22659 | |
| H5 CP 1-3/4 GJ tail | 35810 | |

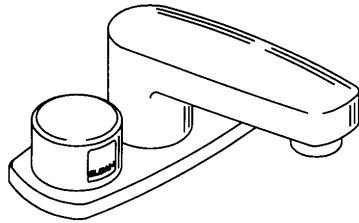

ETF66
Sloan Optima
Electronic sensor operated
faucet

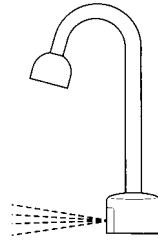

ETF700
Sloan Optima
Electronic sensor operated
deck

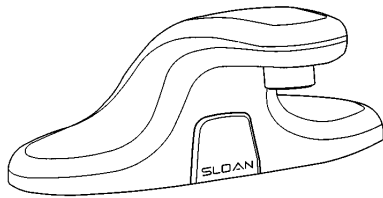

EBF650
Battery Powered
hand washing faucet

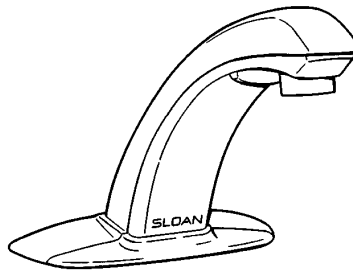

EBF85
Battery Powered
hand washing faucet

**CONTACT YOUR
DUFF COMPANY
REPRESENTATIVE FOR
VARIOUS OPTIONS
AVAILABLE ON THESE
FAUCETS!**



**SLOAN DOUBLE
STATION SCRUB SINK**

Single & Triple Sink available!

ALSO AVAILABLE



VISION SERIES

Central Brass
Electronic Sensor Faucets



AQUA SENSE



SPEAKMAN
SensorFlo

MCC POWERS
PROCESS CONTROLS
E S P



E A G L E E Y E



Delaney closet/urinal flush valves, exposed type

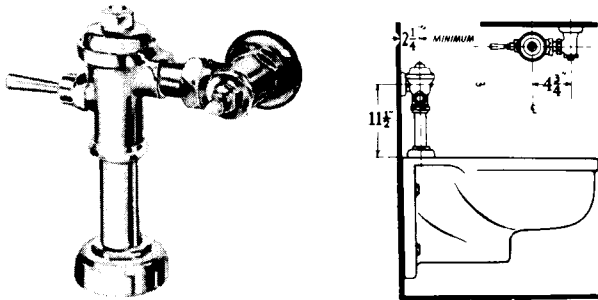

COMPLETE LINE OF REPAIR PARTS AVAILABLE

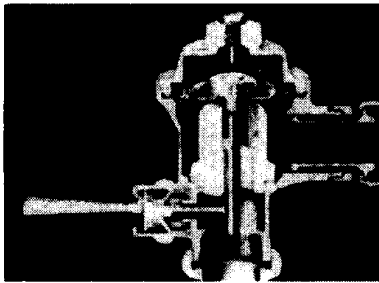

CALL TODAY FOR YOUR PRICING!



Zurn flush valves

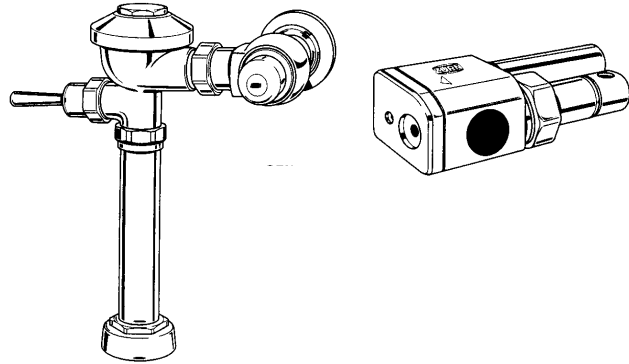

COMPLETE LINE OF REPAIR PARTS AVAILABLE



CALL TODAY FOR YOUR PRICING!



**FIX IT RIGHT
THE FIRST TIME!**

CALL DUFF FOR ADVICE!

610-275-4453

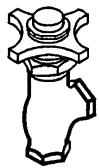

Self Closing Angle Stop

| SIZE | FIG. NO. | PRICE |
|------|----------|-------|
| 3/8 | 8329 | |
| 1/2 | 8334 | |

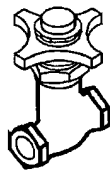

Self Closing Straight Stop

| SIZE | FIG. NO. | PRICE |
|------|----------|-------|
| 3/8 | 8318 | |
| 1/2 | 8324 | |

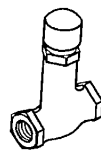

Slow Closing Straight Stop

| SIZE | FIG. NO. | PRICE |
|------|----------|-------|
| 3/8 | 8555 | |
| 1/2 | 8556 | |

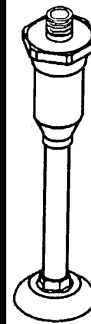

CENTRAL BRASS Standpipe with Vacuum Breaker

| SIZE | FIG. NO. | PRICE |
|------|----------|-------|
| 3/8 | 8340 | |
| 1/2 | 8346 | |

KOHLER K-53415 Urinal Strainer

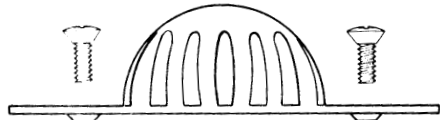

| FIG. NO. | PRICE |
|----------|-------|
| 73450 | |

KOHLER K-18752 Urinal Strainer

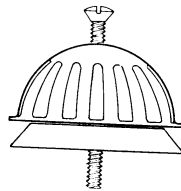

| FIG. NO. | PRICE |
|----------|-------|
| 38844 | |

AMERICAN STANDARD WASHBROOK STRAINER

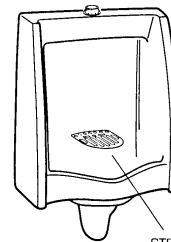

| FIG. NO. | PRICE |
|----------|-------|
| 78808 | |

REPLACEMENT TUB ASSEMBLY

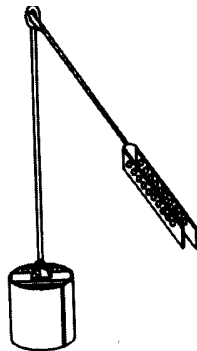

| FIG. NO. | PRICE |
|----------|-------|
| 60434 | |

STERLING Tip Toe Cartridge



| FIG. NO. | PRICE |
|----------|-------|
| 10429 | |

FLIP-IT TUB STOPPER



CP ABS & Delrin plastic. One piece construction. No tools required for installation.

| FIG. NO. | PRICE |
|----------|-------|
| 47002 | |

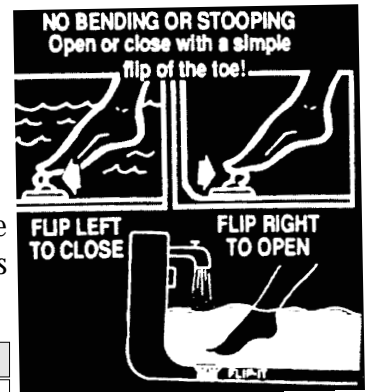

STRAINERS

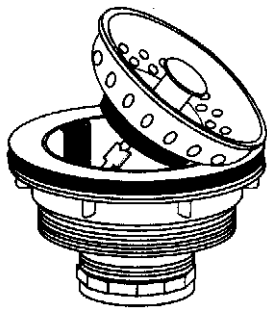

Stainless Duo Strainer - 3 1/2"

| FIG. NO. | PRICE |
|----------|-------|
| 11585 | |

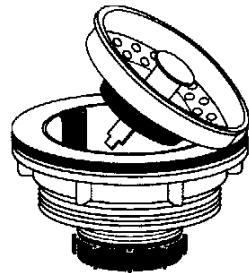

PVC Duo Strainer. Chrome Plated - 3 1/2"

| FIG. NO. | PRICE |
|----------|-------|
| 41508 | |

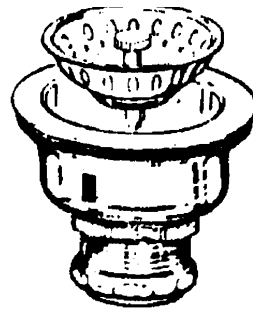

Deep Basket Duo Strainer - 3 1/2"

| FIG. NO. | PRICE |
|----------|-------|
| 11582 | |

BEST QUALITY!

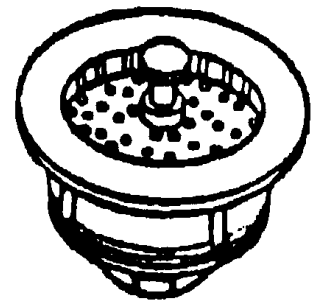

Cast Brass Duo Strainer - 3 1/2"

| FIG. NO. | PRICE |
|----------|-------|
| 43534 | |

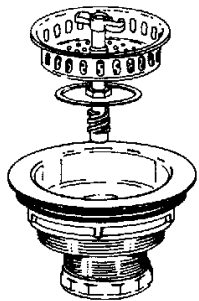

Twist Type Duo Strainer. 3 1/2"
A sure seal!

| FIG. NO. | PRICE |
|----------|-------|
| 51664 | |

Basket Only

| |
|-------|
| 85894 |
|-------|

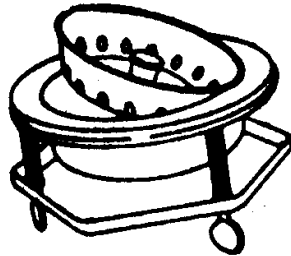

E-Z On Duo For Stainless Sink. 3 1/2"

| FIG. NO. | PRICE |
|----------|-------|
| 11584 | |

**YES!
DUFF
ACCEPTS VISA
AND
MASTERCARD!**

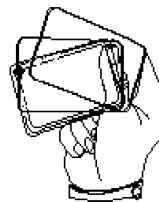

COMMERCIAL GRADE

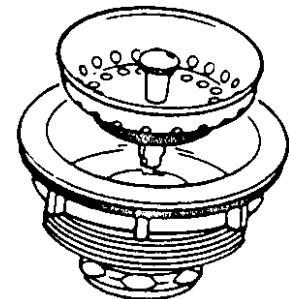

300 Series Stainless Steel Acid Resistant Duo Strainer

| FIG. NO. | PRICE |
|----------|-------|
| 52531 | |

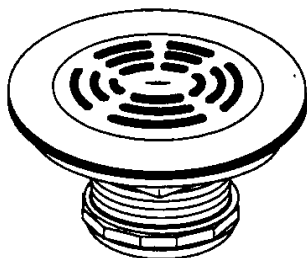

Flat Top Strainer. 4 1/2" Top For sinks with 3" to 4" opening

| FIG. NO. | PRICE |
|----------|-------|
| 49218 | |

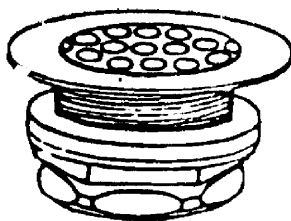

Duplex Strainer 2"

| FIG. NO. | PRICE |
|----------|-------|
| 15330 | |

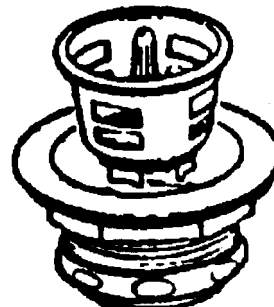

Jr. Duo Strainer 2"

| FIG. NO. | PRICE |
|----------|-------|
| 51674 | |

Basket Only

| |
|-------|
| 85895 |
|-------|

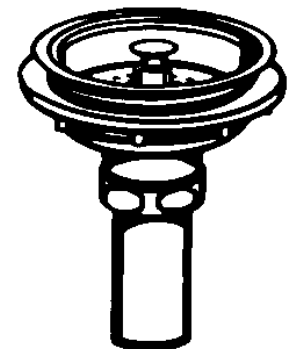

Kohler K8801 Duo Strainer

| FIG. NO. | PRICE |
|----------|-------|
| 44994 | |

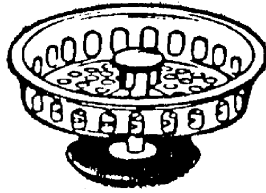

FITALL DUO BASKET

| FIG. NO. | PRICE |
|----------|-------|
| 15328 | |

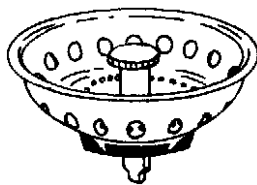

POST STYLE DUO BASKET

| FIG. NO. | PRICE |
|----------|-------|
| 57431 | |

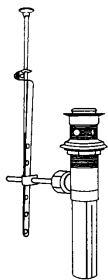

POP-UP DRAIN ASSEMBLY

| FIG. NO. | PRICE |
|----------|-------|
| 14590 | |



MACK WASHER

| | FIG. NO. | PRICE |
|--------|----------|-------|
| 1 1/4" | 14629 | |
| 1 1/2" | 14636 | |



SOAP DISPENSER

| FIG. NO. | PRICE |
|----------|-------|
| 46925 | |

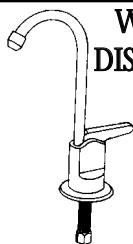

WATER DISPENSER

| FIG. NO. | PRICE |
|----------|-------|
| 23543 | |



FAUCET HOLE COVER
with polished chrome top. 1 3/4" steel body with wingnut.

| FIG. NO. | PRICE |
|----------|-------|
| 14621 | |

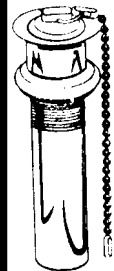

PO BASIN PLUG
1 piece, 5" long

| FIG. NO. | PRICE |
|----------|-------|
| 51665 | |



SNAP-IN HOLE COVER

Stainless Steel. 1 1/2"

| FIG. NO. | PRICE |
|----------|-------|
| 50413 | |

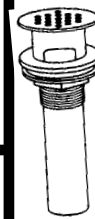

CAST BRASS GRID DRAIN
1 1/4" X 6" 20 Gauge tailpiece. Chrome plated heavy cast brass.

| FIG. NO. | PRICE |
|----------|-------|
| 44613 | |



POP-UP LINKAGE ONLY

| FIG. NO. | PRICE |
|----------|-------|
| 57432 | |

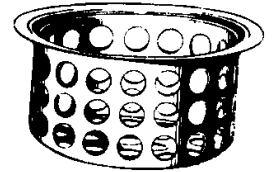

CUP STRAINER

Nickel plated catch all strainer.

| FIG. NO. | PRICE |
|----------|-------|
| 1 3/8 | 17831 |
| 1 1/8 | 17830 |
| 1 1/2 | 17832 |

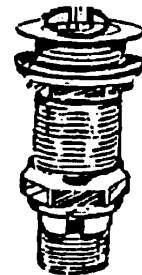

BAR PLUG
Bar sink strainer.

| FIG. NO. | PRICE |
|----------|-------|
| 17840 | |

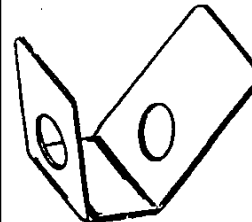

POP-UP ROD CLIP

| FIG. NO. | PRICE |
|----------|-------|
| 57419 | |

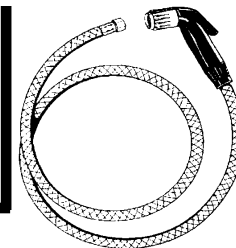

HOSE AND SPRAY ASSEMBLY

| | FIG. NO. | PRICE |
|-----------|----------|-------|
| COMPLETE | 14592 | |
| Hose Only | 14593 | |
| Head Only | 14595 | |

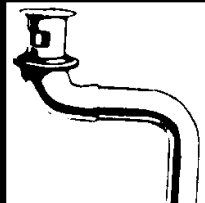

WHEELCHAIR LAVATORY STRAINER - cast brass.

| FIG. NO. | PRICE |
|----------|-------|
| 49389 | |

TUBULAR BRASS



**Chrome Plated Extension Tube
Sweat End**

| SIZE | FIG. NO. | PRICE |
|------------|----------|-------|
| 1 1/4 X 8 | 11905 | |
| 1 1/4 X 12 | 11919 | |
| 1 1/2 X 8 | 11927 | |
| 1 1/2 X 12 | 11932 | |



**Chrome Plated Extension Tube
Slip Joint**

| SIZE | FIG. NO. | PRICE |
|------------|----------|-------|
| 1 1/4 X 8 | 11934 | |
| 1 1/4 X 12 | 11938 | |
| 1 1/2 X 8 | 11943 | |
| 1 1/2 X 12 | 11949 | |



**Chrome Plate Tube Threaded
Both Ends**

| SIZE | FIG. NO. | PRICE |
|------------|----------|-------|
| 1 3/8 x 12 | 11800 | |
| 1 1/2 x 12 | 11816 | |
| 1 1/4 x 12 | 20319 | |

Threaded One End

| SIZE | FIG. NO. | PRICE |
|-------------------|----------|-------|
| 1 1/2 x 1 1/4 x 8 | 11827 | |



Chrome Plated Sink Tailpiece

| SIZE | FIG. NO. | PRICE |
|------------|----------|-------|
| 1 1/4 x 4 | 11838 | |
| 1 1/4 x 8 | 11855 | |
| 1 1/4 x 12 | 64157 | |
| 1 1/2 x 4 | 11875 | |
| 1 1/2 x 8 | 11885 | |
| 1 1/2 x 12 | 11896 | |

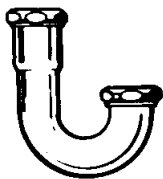

20 Gauge J-Bend

| SIZE | FIG. NO. | PRICE |
|-------|----------|-------|
| 1 1/4 | 11601 | |
| 1 1/2 | 11603 | |

17 Gauge J-Bend

| SIZE | FIG. NO. | PRICE |
|-------|----------|-------|
| 1 1/4 | 11607 | |
| 1 1/2 | 11609 | |

17 Gauge With Clean Out

| SIZE | FIG. NO. | PRICE |
|-------|----------|-------|
| 1 1/4 | 11612 | |
| 1 1/2 | 11616 | |

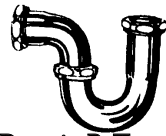

**Repair P-Trap
1 1/4"**

| FIG. NO. | PRICE |
|----------|-------|
| 23241 | |

1 1/2"

| FIG. NO. | PRICE |
|----------|-------|
| 23242 | |

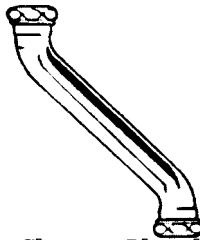

**Chrome Plated
Double Offset
1 1/4"**

| FIG. NO. | PRICE |
|----------|-------|
| 11959 | |

1 1/2"

| FIG. NO. | PRICE |
|----------|-------|
| 11963 | |

**End Outlet
Continuous Waste**



| FIG. NO. | PRICE |
|----------|-------|
| 11652 | |

**Continuous Outlet
Waste**

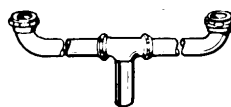

| FIG. NO. | PRICE |
|----------|-------|
| 11656 | |

2" TUBULAR!

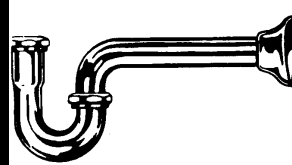

2" 17 Gauge P Trap

| FIG. NO. | PRICE |
|----------|-------|
| 11776 | |



**2" Chrome
Plated, 17
Gauge Tail
Piece**

| FIG. NO. | PRICE |
|----------|-------|
| 11794 | |

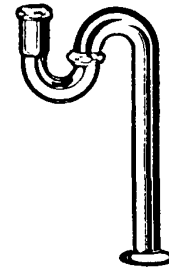

**2" 17 Gauge S-
Trap Less
Cleanout**

| FIG. NO. | PRICE |
|----------|-------|
| 11788 | |

Cast brass cap at end of horizontal runs can be unscrewed to facilitate thorough cleaning and blockage removal.

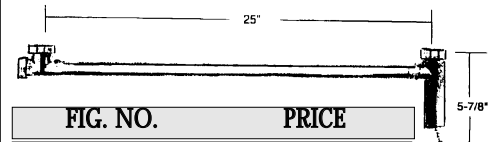

| FIG. NO. | PRICE |
|----------|-------|
| 78994 | |

NOTE: For center to center dimensions less than 25", cut unthreaded end of horizontal tubing to desired length.

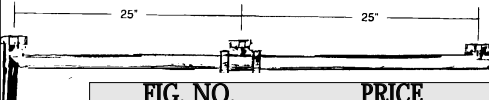

| FIG. NO. | PRICE |
|----------|-------|
| 78996 | |

P-TRAPS

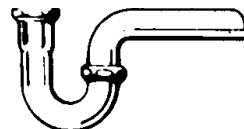

17 Gauge P-Trap

| SIZE | FIG. NO. | PRICE |
|-------|----------|-------|
| 1 1/4 | 11623 | |
| 1 1/2 | 11626 | |

20 Gauge P-Trap

| SIZE | FIG. NO. | PRICE |
|-------|----------|-------|
| 1 1/4 | 11621 | |
| 1 1/2 | 11622 | |

S-TRAPS



**20 Gauge
S-TRAP**

| SIZE | FIG. NO. | PRICE |
|-------|----------|-------|
| 1 1/4 | 11632 | |
| 1 1/2 | 11633 | |

17 Gauge S-Trap

| SIZE | FIG. NO. | PRICE |
|-------|----------|-------|
| 1 1/4 | 11635 | |
| 1 1/2 | 11636 | |

TUBULAR BRASS

ESCUTCHEONS



Chrome Plated Escutcheon

| COP SIZE | IP SIZE | FIG. NO. | PRICE |
|-----------|---------|----------|-------|
| 1/2" | 3/8" | 11732 | |
| | 1/2" | 11736 | |
| TRAP SIZE | | | |
| 1 1/4" | | 11755 | |
| 1 1/2" | | 11759 | |



Chrome Plated Bell Escutcheon

| COP SIZE | IP SIZE | FIG. NO. | PRICE |
|-----------|---------|----------|-------|
| 1/2" | 3/8" | 11739 | |
| | 1/2" | 11744 | |
| TRAP SIZE | | | |
| 1 1/4" | | 11746 | |
| 1 1/2" | | 11748 | |

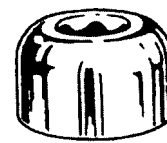

Chrome Plated Tube Box Escutcheon

| TRAP SIZE | FIG. NO. | PRICE |
|-----------|----------|-------|
| 1 1/4" | 11765 | |
| 1 1/2" | 11769 | |

SLIP JOINT FITTINGS - TUBULAR TRAP SIZE - all sizes can reduce to 1 1/4 or 1 3/8

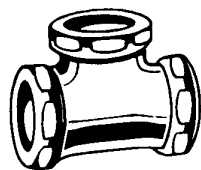

Chrome Plated Slip Joint Tee



Chrome Plated Slip Joint 45

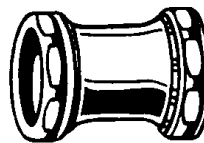

Chrome Plated Slip Joint Coupling

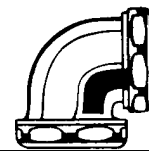

Chrome Plated Slip Joint 90

| SIZE | FIG. NO. | PRICE | SIZE | FIG. NO. | PRICE | SIZE | FIG. NO. | PRICE | SIZE | FIG. NO. | PRICE |
|-------|----------|-------|-------|----------|-------|-------|----------|-------|-------|----------|-------|
| 1 1/4 | 12043 | | 1 1/4 | 12019 | | 1 1/4 | 12033 | | 1 1/4 | 12012 | |
| 1 1/2 | 12044 | | 1 1/2 | 12027 | | 1 1/2 | 12037 | | 1 1/2 | 12016 | |

SLIP JOINT NUTS

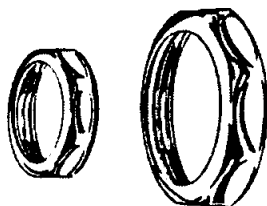

CHROME PLATED SLIP JOINT NUTS

| SIZE | FIG. NO. | PRICE |
|---------------|----------|-------|
| 1 1/4 | 11981 | |
| 1 1/2 | 11991 | |
| 1 1/2 X 1 1/4 | 11997 | |
| 1 1/2 X 1 3/8 | 12003 | |
| 2 | 12008 | |

CHROME PLATED BRASS SLIP JOINT NUTS

| | |
|--------|-------|
| 1 1/4" | 42919 |
| 1 1/2" | 42920 |





The new LAV SHIELD lavatory enclosure represents the "Next Generation" of ADA piping protection systems. An alternative to insulation covers around each pipe and component, the designer-style, single-piece LAV SHIELD conceals all lavatory piping, electronic faucet connections, mixing valves, trap primers, and instantaneous hot water heaters* at once. The LAV SHIELD provides the proper knee and toe clearances mandated by ADA for wheelchair users, prevents pipe component tampering, and offers the aesthetics demanded by the most discriminating of designers.

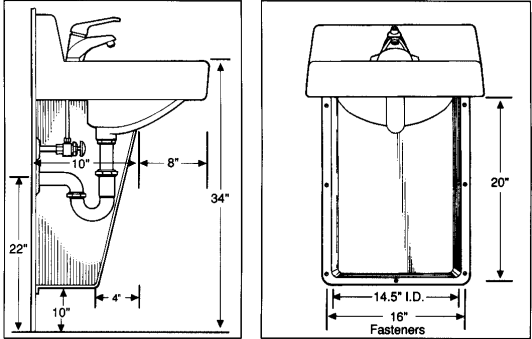

| FIG. NO. | PRICE |
|----------|-------|
| 79924 | |

TUBULAR BRASS

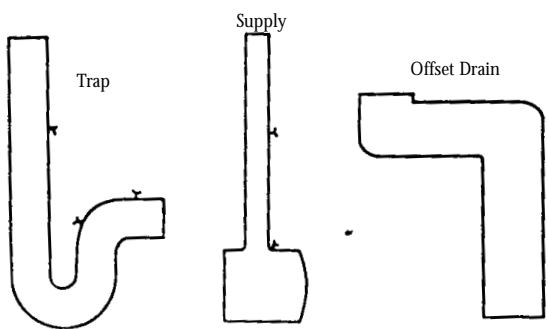

TRAP AND STOP & SUPPLY PROTECTORS (skal-gard) - conforms to provisions of Americans with Disabilities Act (ADA).

| DESCRIPTION | FIG. NO. | PRICE |
|---|----------|-------|
| Fire resistant foam insulation for traps | 48459 | |
| Fire resistant foam insulation for supplies | 48460 | |
| Fire resistant foam insul for offset drains | 61347 | |
| KIT Fire resistant foam insulation for supplies & trap | 47668 | |

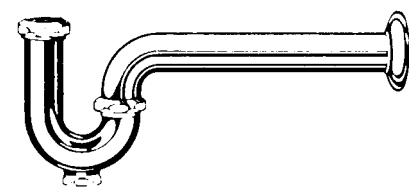

CAST BRASS BODY P TRAP - with cleanout, tubular wall bend

| SIZE | FIG. NO. | PRICE |
|--------|----------|-------|
| 1 1/4" | 61324 | |
| 1 1/2" | 61344 | |

PVC FLEXIDRAIN

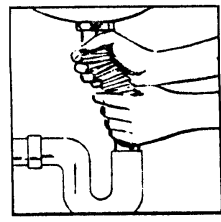
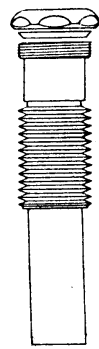

Flexi-drains bend easily to correct mis-alignment. Cuts easily with a hack saw.

| SIZE | FIG. NO. | PRICE |
|--------|----------|-------|
| 1 1/2" | 12160 | |
| 1 1/4" | 12154 | |



SWIVEL SINK TRAP WITH CAST BRASS ELBOW

| SIZE | FIG. NO. | PRICE |
|---------------|----------|-------|
| 1 1/2 | 11647 | |
| 1 1/2 X 1 1/4 | 65055 | |
| 1 1/4 | 65056 | |

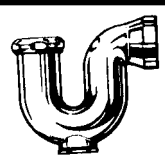

CAST BRASS NY REG. TRAPS Chrome plated for heavy duty service, urinals, etc.

| SIZE | FIG. NO. | PRICE |
|---------------|----------|-------|
| 1 1/2 | 65053 | |
| 1 1/2 X 1 1/4 | 65054 | |

TUBULAR PVC

1 1/2" PVC P-Trap

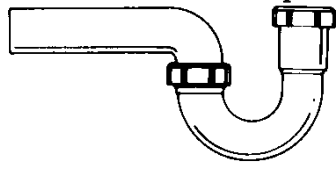

| FIG. NO. | PRICE |
|----------|-------|
| 12056 | |

1 1/2" PVC S-Trap

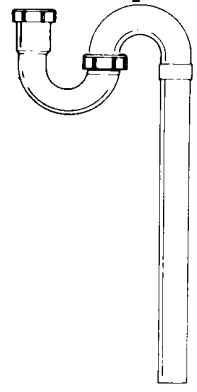

| FIG. NO. | PRICE |
|----------|-------|
| 12059 | |

1 1/2" PVC J-Bend

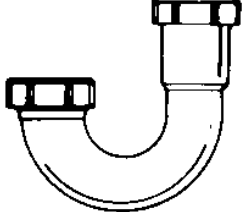

| FIG. NO. | PRICE |
|----------|-------|
| 12047 | |

1 1/2" x 8" PVC Extension Tube

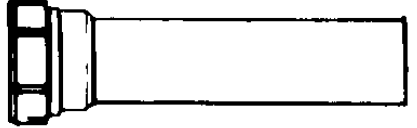

| FIG. NO. | PRICE |
|----------|-------|
| 12110 | |

PVC Center Outlet Continuous Waste

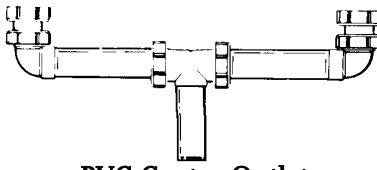

| FIG. NO. | PRICE |
|----------|-------|
| 12073 | |

PVC End Outlet Waste

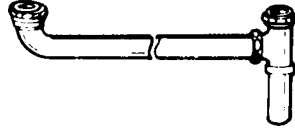

| FIG. NO. | PRICE |
|----------|-------|
| 12067 | |

PVC Tailpiece

1 1/2" X 4

| FIG. NO. | PRICE |
|----------|-------|
| 44329 | |

1 1/2" X 8"

| FIG. NO. | PRICE |
|----------|-------|
| 12079 | |

1 1/2" X 12"

| FIG. NO. | PRICE |
|----------|-------|
| 44330 | |

PVC Tip-Toe Waste

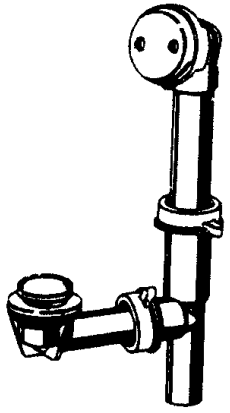

| FIG. NO. | PRICE |
|----------|-------|
| 50146 | |

PVC Trip Waste

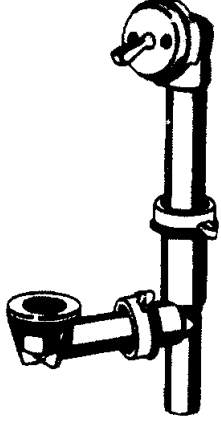

| FIG. NO. | PRICE |
|----------|-------|
| 12149 | |

PVC Dishwasher Tailpiece

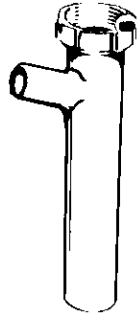

| FIG. NO. | PRICE |
|----------|-------|
| 12135 | |

PVC Slip Joint Nut

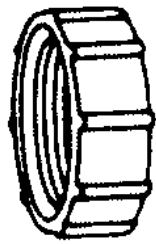

| SIZE | FIG. NO. | PRICE |
|-------|----------|-------|
| 1 1/4 | 47617 | |
| 1 1/2 | 47618 | |

PVC Slip Joint Coupling 1 1/2"



| FIG. NO. | PRICE |
|----------|-------|
| 12137 | |

TUBULAR TRAP SIZE

PVC Slip Joint 90 Degree Elbow 1 1/2"

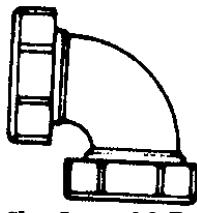

| FIG. NO. | PRICE |
|----------|-------|
| 12142 | |

TUBULAR TRAP SIZE

PVC Slip Joint Tee 1 1/2"

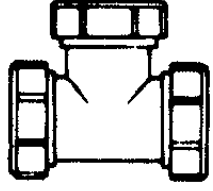

| FIG. NO. | PRICE |
|----------|-------|
| 12146 | |

REPAIR SPLIT NUT

for repair without opening joint!

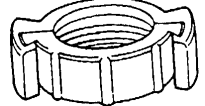

PVC. For use on PVC or chrome traps

| SIZE | FIG. NO. | PRICE |
|-------|----------|-------|
| 1 1/4 | 49311 | |
| 1 1/2 | 47619 | |

CHROME PLATED SUPPLY TUBES



Chrome Lav Supply Tube

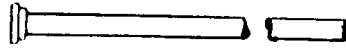

Chrome Closet Supply Tube

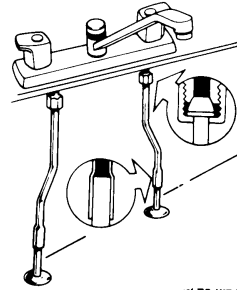

Brass Finish Jiffy Lav Tube. Pair.

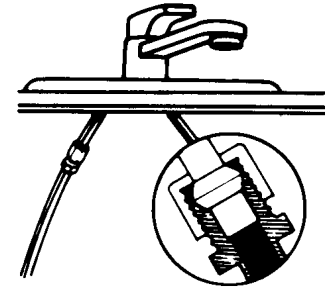

Single Lever Lav Tube
3/8 x 12" Chrome Plated .Each.

| SIZE | FIG. NO. | PRICE |
|-----------|----------|-------|
| 3/8 X 12" | 10930 | |
| 3/8 X 20" | 10931 | |
| 3/8 X 36" | 10934 | |
| 1/2 X 12" | 10937 | |
| 1/2 X 20" | 10939 | |

| SIZE | FIG. NO. | PRICE |
|-----------|----------|-------|
| 3/8 X 12" | 10950 | |
| 3/8 X 20" | 10951 | |
| 1/2 X 12" | 10954 | |
| 1/2 X 20" | 10956 | |

| FIG. NO. | PRICE |
|----------|-------|
| 10967 | |

| FIG. NO. | PRICE |
|----------|-------|
| 10970 | |

CHROME FLANGES



CHROME PLATED IP ESCUTCHEON

| IP SIZE | FIG. NO. | PRICE |
|---------|----------|-------|
| 3/8" | 11732 | |
| 1/2" | 11736 | |

CHROME PLATED SWT ESCUTCHEON

| SIZE | FIG. NO. | PRICE |
|------|----------|-------|
| 1/2" | 11732 | |



Bonding adhesive for shower pan.

| FIG. NO. | PRICE |
|----------|-------|
| 33216 | |

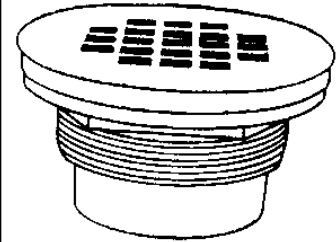

PVC no-caulk shower drain for PVC.

| FIG. NO. | PRICE |
|----------|-------|
| 42800 | |

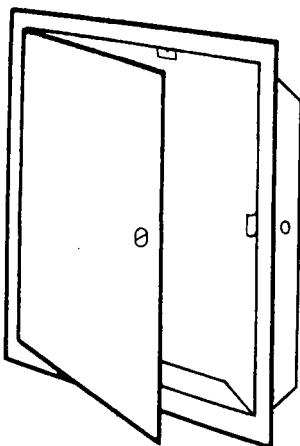

12" Steel Access Panel.

| FIG. NO. | PRICE |
|----------|-------|
| 47032 | |

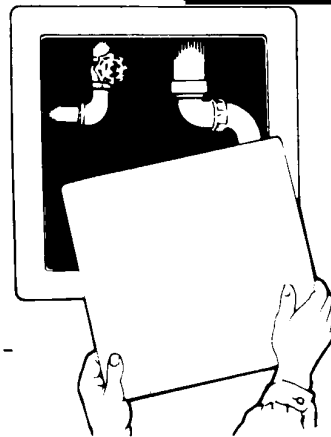

PVC Access Panel. Easy snap cover 14 x 14.

| FIG. NO. | PRICE |
|----------|-------|
| 44597 | |

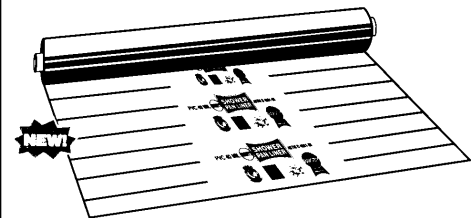

PVC Shower pan. 4 feet wide

| FIG. NO. | PRICE PER SQ. FT. |
|----------|-------------------|
| 33229 | |



3IN1 ROOF FLASHING

Fits 1 1/4", 1 1/2, 2 or 3" vent pipe
Fits any roof pitch-from flat to 45o
Tested for Ultraviolet, Ozone and wather resistance.

Thermoplastic hard base with elastomer collar

| FIG. NO. | PRICE |
|----------|-------|
| 51248 | |

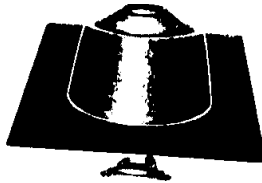

3+4 ROOF FLASHINGS

Fits 3" or 4" vent pipe
Fits any roof pitch-from flat to 45o
Tested for Ultraviolet,

Ozone and wather resistance.

Thermoplastic hard base with elastomer collar

| FIG. NO. | PRICE |
|----------|-------|
| 51249 | |



LABOR, TIME AND INVENTORY SAVINGS!

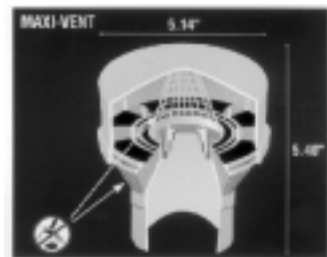

MAXI-VENT - Installed by either push-fit installation on a 2" pipe or in a 4" pipe, or through the use of hubless coupling or solvent weld installation methods on a 3" pipe. Cut off the inner lip of the connector (along guide marks) when used in 4" pipe. The packaging

should be used when installing the Max-Vent in areas subject to extreme temperatures.

| FIG. NO. | PRICE |
|----------|-------|
| 76611 | |

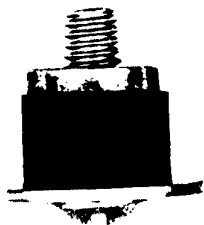

URINAL AND CLEANOUT PLUG -

Replaces bottom cleanout of wall hung china urinal.

| DESCRIPTION | FIG. NO. | PRICE |
|-------------------|----------|-------|
| 3/4" Kohler | 50526 | |
| 5/8" Kohler | 50527 | |
| 1" Crane | 50528 | |
| 3/4" American Std | 50529 | |

TRY AN IN-LINE FILTER FOR BETTER TASTE!

ICE MAKER/HUMIDIFIER KIT-



Self tapping valve, all necessary brass fittings
1/4" OD tubing, FDA approved
Used with most refrigerators, furnace humidiers, coolers

| | FIG. NO. | PRICE |
|---------|----------|-------|
| PLASTIC | 36306 | |
| COPPER | 15345 | |

SELF TAPPING SADDLE VALVE -

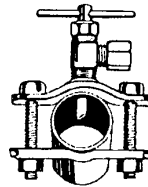

1/2" copper tube x 1/4 OD copper tube
Heavy duty construction

| FIG. NO. | PRICE |
|----------|-------|
| 11030 | |



AUTOMATIC PLUMBING VENT -

Fits 1 1/2" female waste line adapter. Eliminates secondary stack for tubs, sinks, basins, showers and washing machines. BOCA and SBCC approved.

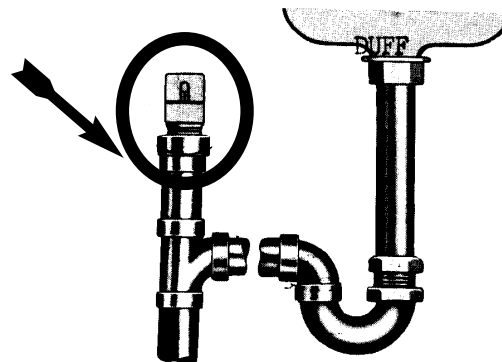

| FIG. NO. | PRICE |
|----------|-------|
| 15333 | |

DISHWASHER DISPOSAL CONNECTIONS (BOOT)

- With 2 stainless steel worm gear clamps.



| FIG. NO. | PRICE |
|----------|-------|
| 18127 | |

SUPER FLEX STAINLESS STEEL NO-BURST CONNECTORS

LAV CONNECTION -

Superflex connector for lavatory.

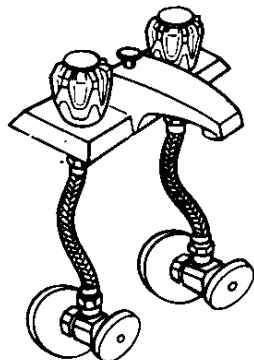

| SIZE | FIG. NO. | PRICE |
|----------|----------|-------|
| 3/8 X 9 | 45375 | |
| 3/8 X 12 | 11033 | |
| 3/8 X 20 | 36270 | |
| 1/2 X 12 | 46962 | |
| 1/2 X 20 | 46987 | |

TOILET CONNECTION -

Superflex connector for the toilet.

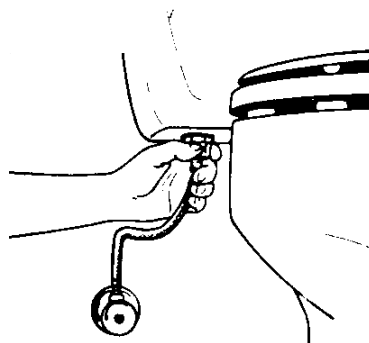

SUPER DELTA FAUCET CONNECTOR.

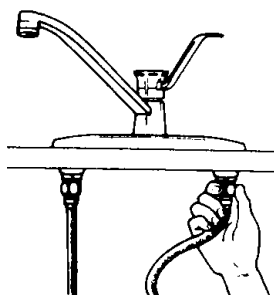

| SIZE | FIG. NO. | PRICE |
|----------|----------|-------|
| 3/8 X 12 | 39911 | |
| 3/8 X 20 | 44600 | |

| SIZE | FIG. NO. | PRICE |
|----------|----------|-------|
| 3/8 X 9 | 45376 | |
| 3/8 X 12 | 11034 | |
| 1/2 X 12 | 46943 | |

NO BURST Braided Stainless
Flexible Washing Machine
Connectors
5 Ft.

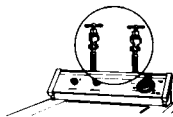
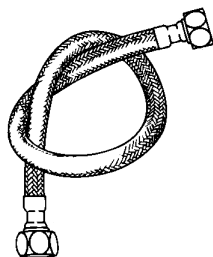

| FIG. NO. | PRICE |
|----------|-------|
| 47351 | |

LOW BOY 1 PIECE TOILET CONNECTION - 1/2" Full flow connection.

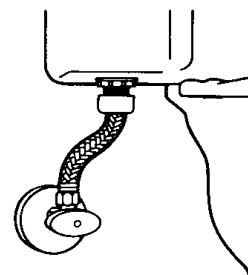

| FIG. NO. | PRICE |
|----------|-------|
| 46943 | |

WATER HEATER CONNECTION

Superflex water heater con-
nector.

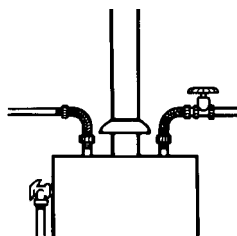

| FIG. NO. | PRICE |
|----------|-------|
| 45398 | |

**CALL
DUFF
FIRST!**

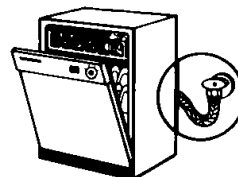

DISHWASHER CONNECTION Superflex dishwasher connector.

| FIG. NO. | PRICE |
|----------|-------|
| 41046 | |

CHROME PLATED SUPPLIES

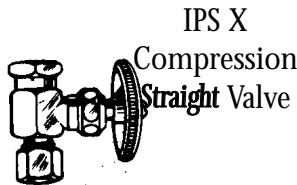

| IPS OD | FIG. NO. | PRICE |
|---------|----------|-------|
| 3/8 3/8 | 10985 | |
| 1/2 1/2 | 10991 | |
| 3/8 1/2 | 10989 | |
| 1/2 3/8 | 10988 | |

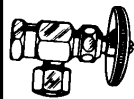

| IPS OD | FIG. NO. | PRICE |
|---------|----------|-------|
| 3/8 3/8 | 10978 | |
| 1/2 1/2 | 10983 | |
| 3/8 1/2 | 10982 | |
| 1/2 3/8 | 10980 | |

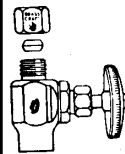

| SWT OD | FIG. NO. | PRICE |
|--------------------|----------|-------|
| 1/2 3/8 | 11001 | |
| ROUGH BRASS | | |
| 1/2 3/8 | 11007 | |

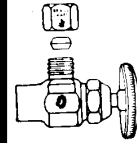

| SWT OD | FIG. NO. | PRICE |
|--------------------|----------|-------|
| 1/2 3/8 | 10998 | |
| ROUGH BRASS | | |
| 1/2 3/8 | 11006 | |

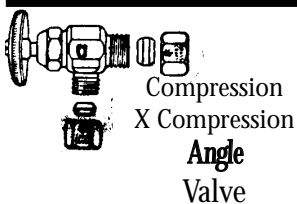

| COP OD | FIG. NO. | PRICE |
|---------|----------|-------|
| 1/2 3/8 | 11004 | |



| COP OD | FIG. NO. | PRICE |
|---------|----------|-------|
| 1/2 3/8 | 11005 | |



| IPS OD | FIG. NO. | PRICE |
|---------|----------|-------|
| 3/8 3/8 | 10995 | |
| 1/2 1/2 | 10997 | |



| IPS OD | FIG. NO. | PRICE |
|---------|----------|-------|
| 3/8 3/8 | 10992 | |
| 1/2 1/2 | 10994 | |

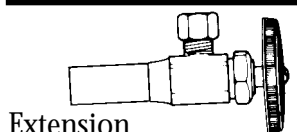

| SWT OD | FIG. NO. | PRICE |
|---------|----------|-------|
| 1/2 3/8 | 11008 | |

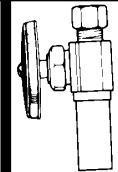

| SWT OD | FIG. NO. | PRICE |
|---------|----------|-------|
| 1/2 3/8 | 11009 | |



| IPS OD | FIG. NO. | PRICE |
|----------------------|----------|-------|
| 3/8 3/8 | 26250 | |
| 1/2 3/8 | 37657 | |
| STRAIGHT Stop | | |
| 3/8 3/8 | 50867 | |

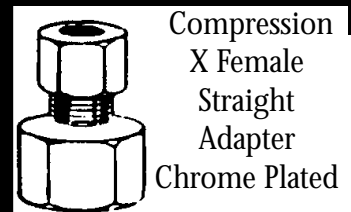

| FIP OD | FIG. NO. | PRICE |
|---------|----------|-------|
| 3/8 3/8 | 11010 | |
| 1/2 1/2 | 11013 | |
| 3/8 1/2 | 11011 | |
| 1/2 3/8 | 11012 | |

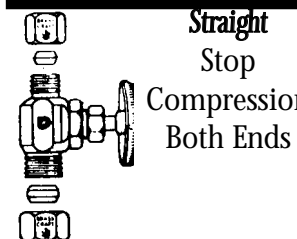

| OD OD | FIG. NO. | PRICE |
|---------|----------|-------|
| 3/8 3/8 | 38584 | |

ESCUTCHEON FOR EXTENSION STOP



| SIZE | FIG. NO. | PRICE |
|------|----------|-------|
| 1/2 | 11739 | |



| IPS OD | FIG. NO. | PRICE |
|---------|----------|-------|
| 3/8 3/8 | 49391 | |

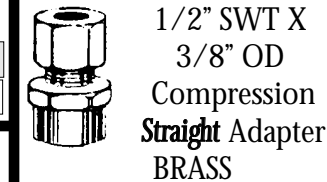

| FIG. NO. | PRICE |
|----------|-------|
| 11022 | |

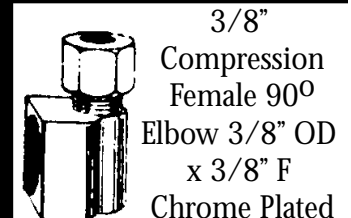

| FIG. NO. | PRICE |
|----------|-------|
| 11018 | |

CHROME PLATED COMPRESSION NUT AND SLEEVE



| COMPRESSION NUT | | |
|------------------------------|----------|-------|
| OD SIZE | FIG. NO. | PRICE |
| 1/2" | 4470 | |
| 3/8" | 4465 | |
| COMPRESSION SLEEVE (FERRULE) | | |
| OD SIZE | FIG. NO. | PRICE |
| 1/2" | 4427 | |
| 3/8" | 4422 | |

WE'RE WAITING FOR YOUR CALL!
610-275-4453

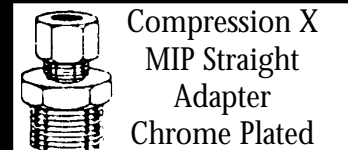

| MIP OD | FIG. NO. | PRICE |
|---------|----------|-------|
| 3/8 3/8 | 11014 | |
| 1/2 1/2 | 11017 | |
| 3/8 1/2 | 11015 | |
| 1/2 3/8 | 11016 | |

WASHING/DISHWASHER MACHINE ACCESSORIES

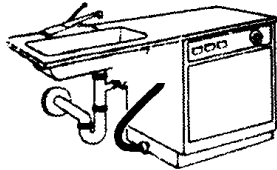

DISHWASHER HOSE - Braided with a rayon tire grade cord. An extremely durable hose - resists kinking.

| FIG. NO. | PRICE |
|----------------|-------|
| 5/8 X 50' COIL | 15321 |
| 5/8 PER FT | 18123 |
| 7/8 X 50' COIL | 15322 |
| 7/8 PER FT | 18124 |

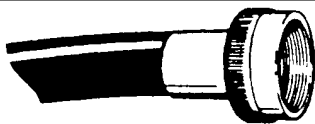

Washing Machine High Pressure Inlet

Hoses. 1/2" ID. Straight Female Swivel Hose Connection Both Ends

| LENGTH | FIG. NO. | PRICE |
|--------|----------|-------|
| 4 Feet | 15317 | |
| 5 Feet | 15318 | |
| 6 Feet | 15319 | |
| 8 Feet | 15320 | |



Fit All Washing Machine Hook Hose

| FIG. NO. | PRICE |
|----------|-------|
| 15315 | |

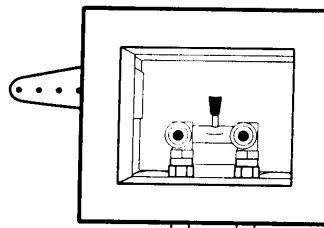

Plastic washing machine box with valve

| FIG. NO. | PRICE |
|----------|-------|
| 42528 | |

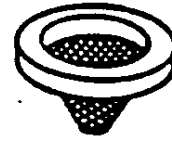

Inlet Hose Filter Screen

| FIG. NO. | PRICE |
|----------|-------|
| 14759 | |

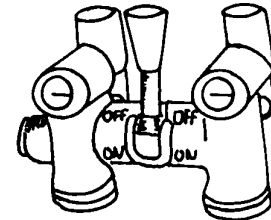

WATTS #2 Washing Machine Shut-Off Valve

| FIG. NO. | PRICE |
|----------|-------|
| 5732 | |

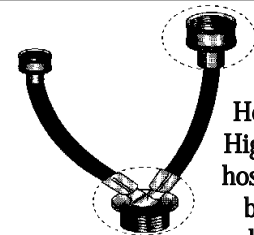

Hose Mixer. High pressure hose and solid brass couplings. 12" arms.

| FIG. NO. | PRICE |
|----------|-------|
| 15316 | |

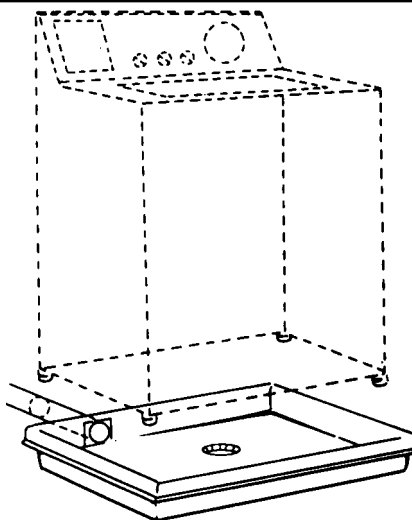

Washing machine Drip Pan - Includes PVC drain fitting. High impact ABS plastic. Will not rust or corrode. 1" drain - can pass all codes. Bottom or side outlet. Easy to install. ID - 27" x 29" OD - 32" x 30" x 2" DEEP

| FIG. NO. | PRICE |
|----------|-------|
| 19003 | |

ROUGH PLUMBING



Caulking Lead. 5 LB block.

| FIG. NO. | PRICE |
|----------|-------|
| 11108 | |



Lead Wool. 5 LB bag.

| FIG. NO. | PRICE |
|----------|-------|
| 11118 | |



Lavatory Hanger for iron lavatories. Extra heavy cast iron.

| FIG. NO. | PRICE |
|----------|-------|
| 62330 | |

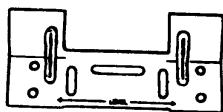

China Lav Hanger Stamped Steel

| FIG. NO. | PRICE |
|----------|-------|
| 50523 | |

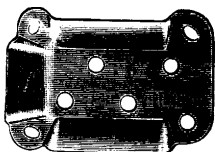

Two piece sink hanger Stamped Steel

| FIG. NO. | PRICE |
|----------|-------|
| 7427 | |

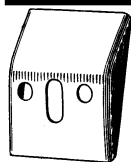

Two piece china basin hanger. Stamped Steel

| FIG. NO. | PRICE |
|----------|-------|
| 50858 | |



Sta Brite Silver Bearing Solder. 1 LB!

| FIG. NO. | PRICE |
|----------|-------|
| 11121 | |

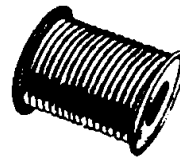

Lead Free Solder. 1 LB spool.

| FIG. NO. | PRICE |
|----------|-------|
| 36274 | |

95/5 Solder. 1 LB spool.

| FIG. NO. | PRICE |
|----------|-------|
| 11117 | |



Oakum 5# Box

| FIG. NO. | PRICE |
|----------|-------|
| 7511 | |

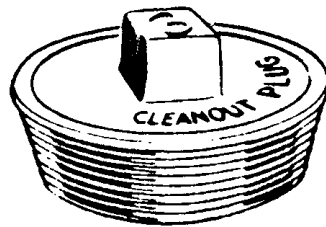

Lead Cleanout Plugs

| SIZE | FIG. NO. | PRICE |
|-------|----------|-------|
| 1 1/2 | 17592 | |
| 2 | 17593 | |
| 2 1/2 | 17594 | |
| 3 | 17595 | |
| 3 1/2 | 17596 | |
| 4 | 17597 | |
| 4 1/2 | 17598 | |
| 5 | 17599 | |

Sheet Lead



| SIZE | WEIGHT | FIG. NO. | PRICE |
|------|--------|----------|-------|
| 3X3 | 3 LB | 11123 | |
| 4X4 | 4 LB | 50141 | |
| 4X4 | 4 LB | 11122 | |
| 4X4 | 4 LB | 11124 | |



Old Style Laundry Tray FUNNEL

| FIG. NO. | PRICE |
|----------|-------|
| 11716 | |

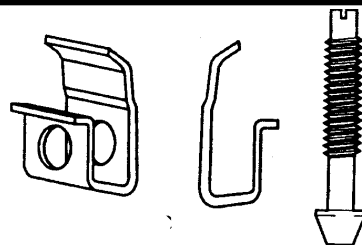

SINK CLIP Screw and clip. For Elkay, Moen, Federal.

| FIG. NO. | PRICE |
|----------|-------|
| 50797 | |



Old style lavatory tray sink collar.

| FIG. NO. | PRICE |
|----------|-------|
| 7425 | |

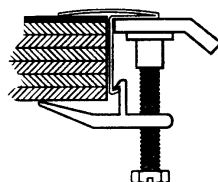

SINK CLIP Fits old stype Hudee rings & many sinks & bowls.

| FIG. NO. | PRICE |
|----------|-------|
| 62329 | |



Sink funnel gasket

| FIG. NO. | PRICE |
|----------|-------|
| 61422 | |

STAINLESS STEEL SINKS

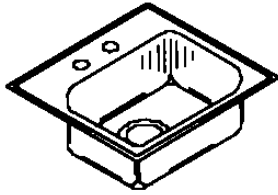

Self - Rimming
15 X 15 Stainless Steel Bar
Sink Less Fittings

| FIG. NO. | PRICE |
|----------|-------|
| 14677 | |

Self-Rimming
15 X 15 Stainless Steel Bar
Sink Package
(includes faucet and duplex strain-
er)

| FIG. NO. | PRICE |
|----------|-------|
| 14675 | |

COMMERCIAL DROP- IN BOWL

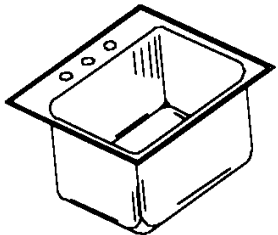

Call us! Many sizes are
available!

| FIG. NO. | PRICE |
|----------|-------|
| DCSSS1 | |

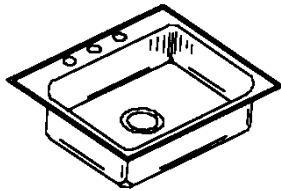

PREMIUM GRADE
High Polish Self-rimming
22 X 25 Stainless Steel
Sink

| FIG. NO. | PRICE |
|----------|-------|
| 43260 | |

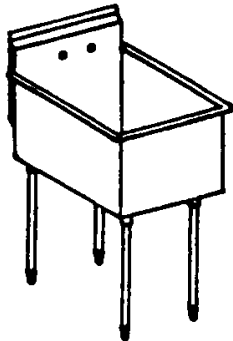

21 X 24 Stainless Steel
Utility Sink

| FIG. NO. | PRICE |
|----------|-------|
| 18153 | |

24 X 24 Stainless Steel
Utility Sink

| FIG. NO. | PRICE |
|----------|-------|
| 22389 | |

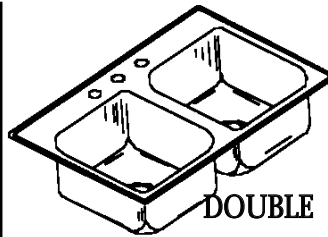

DOUBLE
Self-rimming
22 X 32 Stainless Steel Sink

| FIG. NO. | PRICE |
|----------|-------|
| 14671 | |

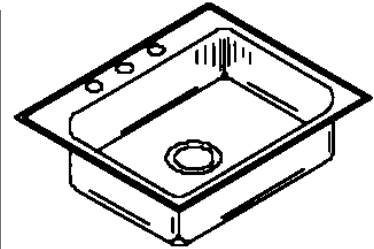

Self-rimming 22 X 25 Stainless
Steel Single Bowl Sink.

| FIG. NO. | PRICE |
|----------|-------|
| 14673 | |



16 1/2 X 18 1/2
Combination Hand Sink

| FIG. NO. | PRICE |
|----------|-------|
| 14678 | |



Combination
Hand Sink com-
plete with faucet
and lever waste.

| FIG. NO. | PRICE |
|----------|-------|
| 73477 | |

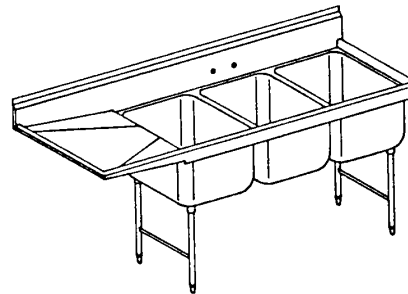

TWO OR THREE
COMPARTMENT SINKS
AVAILABLE IN UTILITY
AND FOOD GRADE
STYLES WITH LEFT
AND/OR RIGHT HAND
DRAIN BOARDS!
FOR SANITIZING BOOSTER,
PLEASE SEE PAGE 276 IN
THE HEATING SECTION!

DRAINBOARDS AVAILABLE!

CORNER COVE SINKS

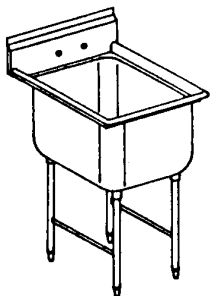

Stainless Steel Single
Bowl Corner Cove
Sink

| FIG. NO. | PRICE |
|----------|-------|
| DCSSS2 | |



For restaurant
applications

Available in all sizes
~ 12" and 14"
depths.

Call for specs and
prices!

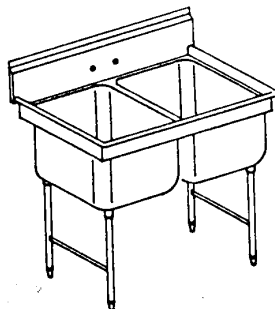

Stainless Steel Double
Bowl Corner Cove Sink

| FIG. NO. | PRICE |
|----------|-------|
| DCSSS3 | |

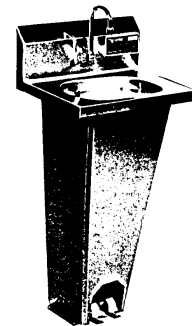

Pedestal Mounted Process Sink with Foot
Valves.

Comes complete with spout, soap
dispenser and strainer!

| FIG. NO. | PRICE |
|----------|-------|
| 73493 | |

LAUNDRY TRAYS



LAUNDRY TRAY
DURASTONE
Heavy Duty

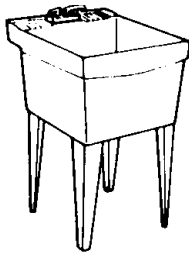

SINGLE BOWL
23 1/2 X 23 W

| FIG NO | PRICE |
|------------------|-------|
| wall mount 7946 | |
| floor mount 7941 | |



DOUBLE BOWL
24 X 40 W

| FIG NO | PRICE |
|------------------|-------|
| wall mount 7950 | |
| floor mount 7948 | |

Chrome Plated Laundry Tray
Faucet

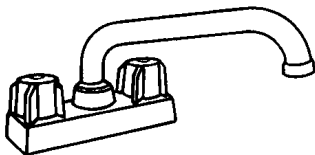

| FIG. NO. | PRICE |
|----------|-------|
| 14582 | |

LAUNDRY TRAY
UTILITUB

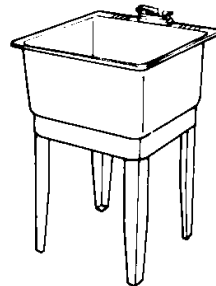

SPACE SAVER STYLE
23 X 18 1/2

| FIG. NO. | PRICE |
|----------|-------|
| 7939 | |

DURASTONE
Mop Basin, 10" height

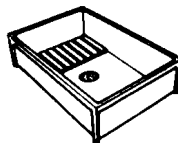

Complete with MOLDED PVC drain assembly - includes black drain seal to 2" or 3" iron, PVC or ABS

| SIZE | DRAIN | FIG. NO. | PRICE |
|-------|-------|----------|-------|
| 24X24 | 3" | 47673 | |
| 24X36 | 3" | 47674 | |

Rough Brass Laundry Tray
Faucet

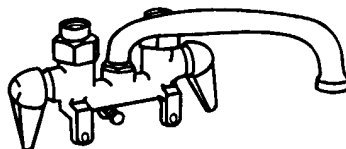

| FIG. NO. | PRICE |
|----------|-------|
| 8147 | |

LAUNDRY/UTILITY BAR SINK
SELF-RIMMING
countertop installation

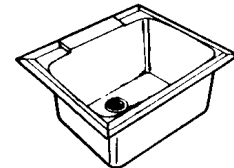

| FIG. NO. | PRICE |
|-------------|-------|
| 25X25X13 | 29091 |
| 20X17X10 | 85896 |
| 15X15X7 3/4 | 85897 |

Faucet Block.

Reinforced white plastic with 1 1/4" steel washers and screws use with overhead faucet supply. 1 1/4" x 5 1/2" - 1 3/8" deep

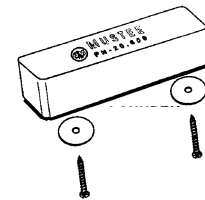

| FIG. NO. | PRICE |
|----------|-------|
| 8244 | |

DURATUB
Laundry Tray
cabinet model, appliance sized,
factory assembled.
28 X 19 W X 35 1/2



| FIG. NO. | PRICE |
|----------|-------|
| 7954 | |



COMMERCIAL CHINA

CADET II EL 1.6



1.6 GPF Elongated Toilet (Vitreous China)

- LESS SEAT
- 12" rough
- Siphon flushing action
- Speed connect tank/bowl coupling system
- Color matched trip lever
- WHITE

Other colors available!

| FIG. NO. | PRICE |
|----------|-------|
| 52690 | |

CADET II RF 1.6



1.6 GPF Round Front Toilet (Vitreous China)

- LESS SEAT
- 12" rough
- Siphon flushing action
- Speed connect tank/bowl coupling system
- Color matched trip lever
- WHITE

Other colors available!

| FIG. NO. | PRICE |
|----------|-------|
| 52689 | |

CADET II 17" HIGH ELONGATED 1.6 GPF



1.6 GPF Elongated (Vitreous China)

- LESS SEAT
- 12" rough
- Siphon flushing action
- Speed connect tank/bowl coupling system
- Color matched trip lever
- WHITE

Other colors available!

| FIG. NO. | PRICE |
|----------|-------|
| 55214 | |



when installed, top of seat is 17" to 19" from the finished floor.

CADET 1.6 PA

1.6 GPF Pressure Assisted Elongated



- LESS SEAT
- 12" rough
- Pressure assisted siphon jet flushing action
- Speed connect tank/bowl coupling system with hex nuts
- Color matched trip lever
- WHITE
- Other colors available!

| FIG. NO. | PRICE |
|-----------------|-------|
| ROUND 50312 | |
| ELONGATED 55657 | |

CADET II 1.6 ROUND

1.6 GPF Round Front Toilet



- LESS SEAT
- 10" or 14" rough
- Siphon jet flushing action
- Speed connect tank/bowl coupling system
- Color matched trip lever
- WHITE
- Other colors available!

| FIG. NO. | PRICE |
|-----------|-------|
| 10" 55218 | |
| 14" 50311 | |

AFWALL ELONGATED

Wall Hung Flush Valve Toilet (Vitreous China)

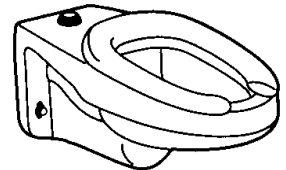

- LESS SEAT
- Top spud
- Siphon jet flushing action
- WHITE
- Other colors available!

| FIG. NO. | PRICE |
|----------|-------|
| 43256 | |

MADERA ELONGATED

1.6 GPF Elongated Toilet (Vitreous China)



- 1.6 GPF
- LESS SEAT
- 14 1/8" rim height
- 10" rough
- Top spud
- Flush valve toilet
- WHITE
- Other colors available!

| FIG. NO. | PRICE |
|----------|-------|
| 14641 | |

MADERA 17" ELONGATED

1.6 GPF ELONGATED TOILET (Vitreous China)



- 1.6 GPF
- LESS SEAT
- 17" rim height
- 10" rough
- Top spud
- Flush valve toilet
- WHITE
- Other colors available!

| FIG. NO. | PRICE |
|----------|-------|
| 49107 | |

CALL DUFF FIRST FOR

AMERICAN STANDARD
 KOHLER
 MOEN
 DELTA
 T&S
 ZURN
 BRADLEY
 HALSEY TAYLOR
 SLOAN
 AND
 POWERS

COMMERCIAL CHINA

GLENWALL EL

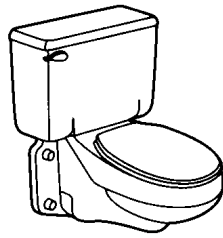

Elongated toilet
(vitreous china)
● Less Seat
● Siphon Jet flushing action

● White

| FIG. NO. | PRICE |
|----------|-------|
| 56354 | |

WASHBROOK

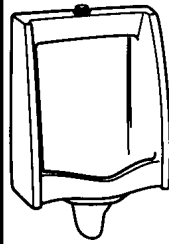

0.7-1.0 GPF Urinal
(Vitreous China)
● Washout flush action
● 14" extended rim
● Meets ANSI flush requirements with low flow flush valve at 0.7 to 1.0 GPF (min. GPM 8.0 flow rate).

- 3/4" top spud
- Wall hangers
- Outlet connection.
- WHITE Other colors available!

| FIG. NO. | PRICE |
|----------|-------|
| 43248 | |

TRIMBROOK

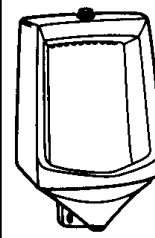

.085-1.0 GPF Urinal
(Vitreous China)
● Siphon jet flush action
Meets ANSI flush requirements with low flow flush valve at .085 to 1.0 GPF (min. GPM 13.0 flow rate).

- 3/4" top spud
- Wall hangers
- Outlet connection.
- WHITE Other colors available!

| FIG. NO. | PRICE |
|----------|-------|
| 43246 | |

AQUALYN COUNTER-TOP LAVATORY (Vitreous China)

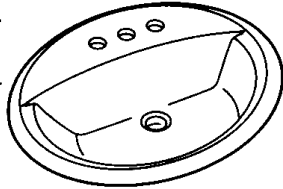

- Self-rimming
- Template and color-matched sealant included!
- 508x432mm (20"x17")
- WHITE Other colors available!

| FIG. NO. | PRICE |
|----------|-------|
| 43250 | |

RONDALYN COUNTERTOP LAVATORY (Vitreous China)

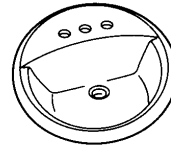

- Self-rimming
- Template
- 483mm (19" diameter)
- WHITE Other colors available!

| FIG. NO. | PRICE |
|----------|-------|
| 43249 | |

ALLBROOK

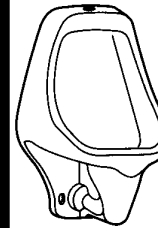

0.7-1.0 GPF Urinal
(Vitreous China)
● Siphon jet flush action
● 14" extended rim
● Meets ANSI flush requirements with low flow flush valve at .07 to 1.0 GPF (min. GPM 8.0 flow rate).

- 3/4" top spud
- Wall hangers
- Outlet connection.
- WHITE Other colors available!

| FIG. NO. | PRICE |
|----------|-------|
| 43245 | |

WHEEL CHAIR USERS LAVATORY WALL HUNG LAVATORY (Vitreous China)

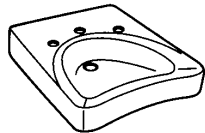

- 686x508mm (27"x20")
- Faucet holes on 102 mm (4") centers
- Arranged for concealed arm carrier by others.
- WHITE Other colors available!

| FIG. NO. | PRICE |
|----------|-------|
| 50314 | |

CORNER MINETTE WALL HUNG LAVATORY (Vitreous China)

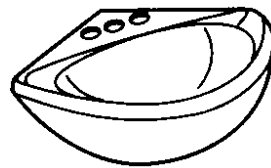

- 279X413MM (11"X16 1/4")
- Faucet holes on 102mm (4") centers
- Furnished with 2 wall hangers
- WHITE Other colors available!

| FIG. NO. | PRICE |
|----------|-------|
| 61781 | |

LUCERNE WALL HUNG LAVATORY (Vitreous China)

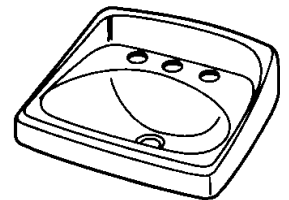

- 508x457 mm (20"x18")
- Faucet holes on 102mm (4") centers
- Wall hanger included
- Concealed arms by others
- WHITE Other colors available!

| FIG. NO. | PRICE |
|----------|-------|
| 44592 | |

ECONOMY CHINA FIXTURES

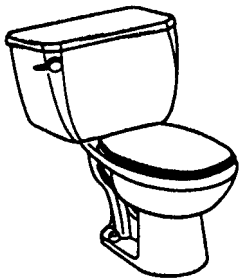

HYDROMISER
1.6 gallon combination. Economy model. LESS SEAT. White. Other colors available!

| SIZE | FIG. NO. | PRICE |
|------|----------|-------|
| 12" | 55168 | |
| 10" | 55200 | |
| 14" | 55208 | |

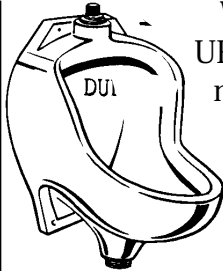

WALL HUNG URINAL. Economy model. White. Other colors available!

| FIG. NO. | PRICE |
|----------|-------|
| 14649 | |

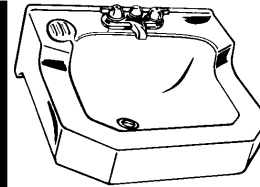

WALL HUNG LAVATORY. Economy model. White. Other colors available!

| SIZE | FIG. NO. | PRICE |
|-------|----------|-------|
| 19X17 | 17669 | |
| 15X12 | 20320 | |
| 20X18 | 53696 | |

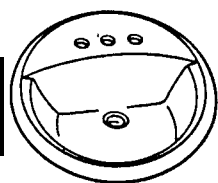

ROUND CHINA BOWL Economy model. White. Other colors available!

| FIG. NO. | PRICE |
|----------|-------|
| 43237 | |

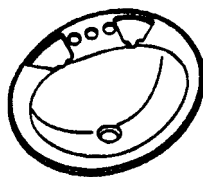

PORCELAIN ON STEEL ROUND LAVATORY BOWL. 19" round, 4" center. White. Other colors available! Self-rimming.

| FIG. NO. | PRICE |
|----------|-------|
| 14661 | |

ENAMELED STEEL TUBS WHITE.

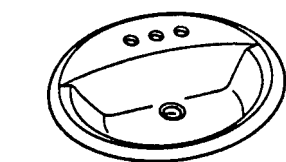
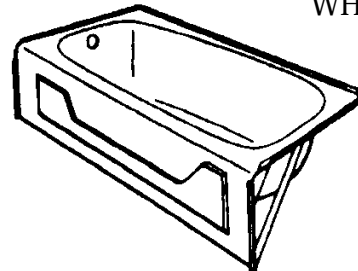

OVAL CHINA BOWL Economy model. White. Other colors available!

| FIG. NO. | PRICE |
|----------|-------|
| 43239 | |

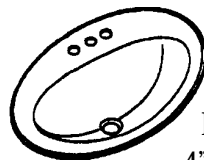

PORCELAIN ON STEEL OVAL LAVATORY BOWL. 20"X17", 4" center. White. Other colors available! Self-rimming.

| FIG. NO. | PRICE |
|----------|-------|
| 14664 | |

| SIZE | FIG. NO. | PRICE |
|-----------|----------|-------|
| 5' LH | 44462 | |
| 5' RH | 14652 | |
| 4 1/2' RH | 44445 | |
| 4 1/2' LH | 44464 | |

OTHER COLORS ARE AVAILABLE!



BATHROOM VANITY
Vanity Colors: white, driftwood, oak and walnut. Cultured marble top colors: gold/white, carara white, cremo, avacado, blue, pink, gold/black. Call us now for color chart and information on styles!

| DESCRIPTION | FIG. NO. | PRICE |
|-----------------------------|----------|-------|
| 19x16 vanity white complete | 14599 | |
| 19x16 vanity color complete | 43464 | |
| 24x19 vanity white complete | 14604 | |
| 24x19 vanity color complete | 43463 | |
| 31x22 vanity top | 14624 | |

COMBINATION FRIDGE, SINK & STOVE!



COMBINATION REFRIGERATOR, SINK AND STOVE. 30" to 48" wide. Call now for specs and prices!

ALSO READILY AVAILABLE THROUGH DUFF COMPANY



Roof Drain

READILY AVAILABLE!



Domes.
Available in
Cast Iron or
Plastic

READILY AVAILABLE!



Gravel Stop.
Please specify the
manufacturer of
your drain!

READILY AVAILABLE!



Floor Drain

READILY AVAILABLE!

GREASE INTERCEPTORS

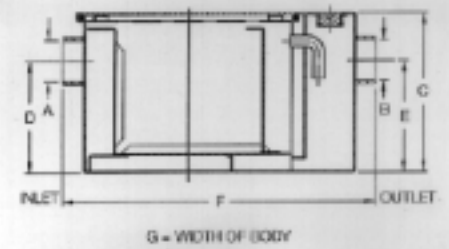
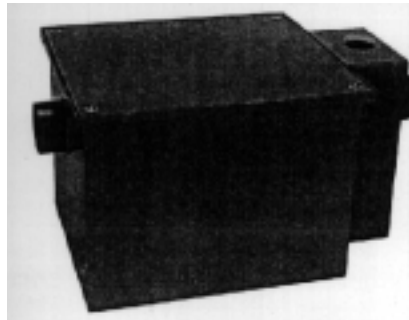

Recommended for removing and retaining grease from wastewater in kitchen and restaurant areas where food is prepared. Grease trap is corrosion-resistant coated fabricated steel with no-hub connections, flow diffusing baffle, integral trap, and vented inlet flow control device.

Chair Hanger, Wall Hung Toilet Support

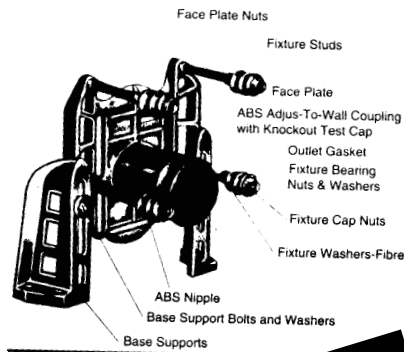

READILY AVAILABLE!

| FIG. NO. | FLOW RATE GPM | SIZE | INLET AND OUTLET | PRICE |
|------------|------------------|-----------------|---------------------|-------|
| GT-2700-4 | 4 | 10 X 22 | 2 | |
| GT-2700-7 | 7 | 11 1/4 X 23 | 2 | |
| GT-2700-10 | 10 | 11 3/4 X 25 | 2 | |
| GT-2700-15 | 15 | 13 3/8 X 27 | 2 | |
| GT-2700-20 | 20 | 15 X 30 | 3 | |
| GT-2700-25 | 25 | 17 X 32 | 3 | |
| GT-2700-35 | 35 | 18 3/4 X 33 3/4 | 4 | |
| GT-2700-50 | 50 | 21 1/2 X 36 | 4 | |

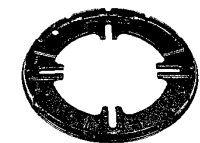

Fit all gravel clamp.

READILY AVAILABLE!

Hair Trap. Available 1 1/4,
1 1/4 x 1 1/2, 1 1/2

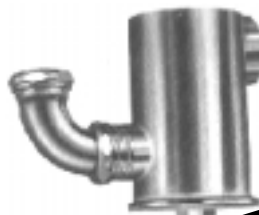

READILY AVAILABLE!

Concealed Arms, Lavatory Hangers.



READILY AVAILABLE!

TOILET SEATS

Elongated Commercial Seat - Open front, less cover. Solid Plastic.

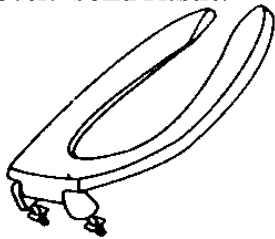

| COLOR | FIG. NO. | PRICE |
|-------|----------|-------|
| White | 7185 | |
| Black | 7184 | |

Elongated Commercial Seat - Open front, with cover. WHITE. Solid Plastic.

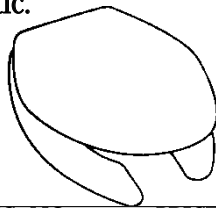

| FIG. NO. | PRICE |
|----------|-------|
| 7181 | |

Round Commercial Seat - Open front, less cover. Solid Plastic.

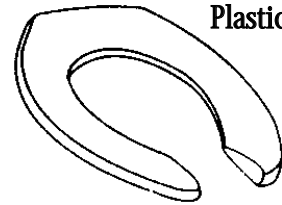

| COLOR | FIG. NO. | PRICE |
|-------|----------|-------|
| White | 7175 | |
| Black | 7176 | |

Round Commercial Seat Closed front, with cover. Solid plastic. White.

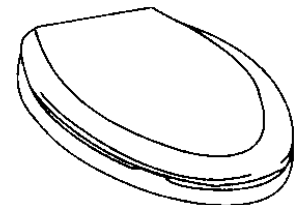

| FIG. NO. | PRICE |
|-------------------|-------|
| 33839 | |
| <i>OPEN FRONT</i> | |
| FIG. NO. | PRICE |
| 7173 | |

Elongated Residential Seat - Closed front, with cover. Solid Plastic.

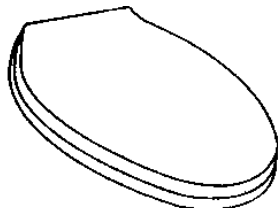

| COLOR | FIG. NO. | PRICE |
|--------|----------|-------|
| White | 33847 | |
| Bone | 33848 | |
| Beige | 46947 | |
| Silver | 47341 | |
| Blue | 47342 | |

Extra Heavy Elongated Commercial Seat - Open front, less cover. Solid Plastic.

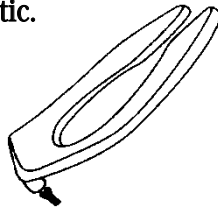

| COLOR | FIG. NO. | PRICE |
|-------|----------|-------|
| White | 7177 | |
| Black | 7178 | |

Elongated Residential Seat - Closed front, with cover. Molded wood.

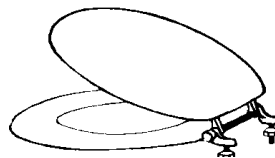

| COLOR | FIG. NO. | PRICE |
|-------|----------|-------|
| White | 19156 | |

Round Residential Seat - Closed front, with cover. Molded wood.

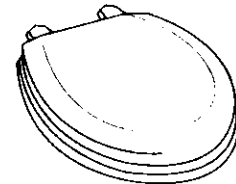

| COLOR | FIG. NO. | PRICE |
|--------|----------|-------|
| White | 7231 | |
| Beige | 7234 | |
| Silver | 46948 | |
| Bone | 46949 | |
| Pink | 46950 | |
| Black | 46951 | |
| Blue | 46952 | |
| Gold | 46953 | |

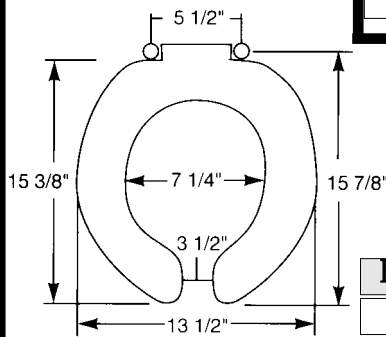

YOUTH open front less cover

| FIG. NO. | PRICE |
|----------|-------|
| 33856 | |

BEMIS

BEMIS

MEDICAID SEAT - Fits flush valve or tank type closet.

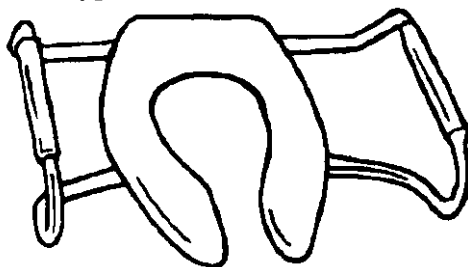
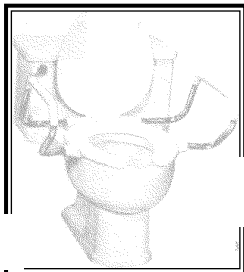

| COLOR | FIG. NO. | PRICE |
|--------------------|----------|-------|
| Elongated less lid | 7230 | |
| Elongated with lid | 7223 | |
| Round less lid | 7220 | |
| Round with lid | 7218 | |

LIFT SEAT - Raises seat to 20 1/2" both seat and lift raise for easy cleaning. Seat sold separately.

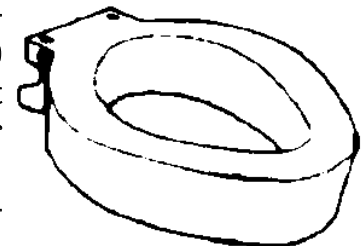

| DESCR | FIG. NO. | PRICE |
|-----------|----------|-------|
| Elongated | 49190 | |
| Round | 19157 | |

TOILET REPAIRS

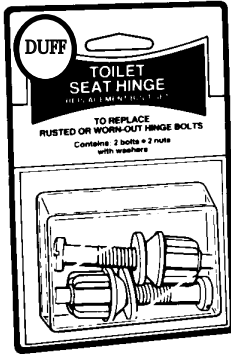

Toilet Seat Hinge Bolt Set. Pair.

| FIG. NO. | PRICE |
|----------|-------|
| 49221 | |



Close Coupled Bolt and Washer Kit. Pair.

| FIG. NO. | PRICE |
|----------|-------|
| 47852 | |

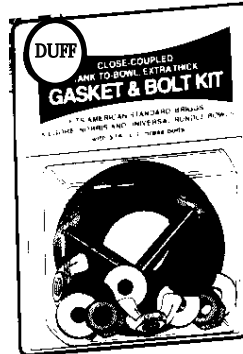

Close couple bolt, washers and tank to bowl gasket kit.

| FIG. NO. | PRICE |
|----------|-------|
| 66808 | |
| 47853 | |
| 66809 | |
| 66810 | |

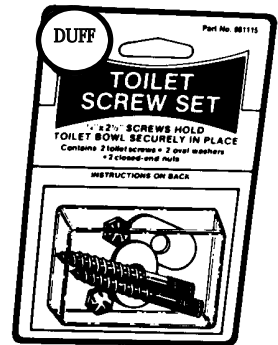

Toilet Screw Set. Pair.

| FIG. NO. | PRICE |
|----------|-------|
| 15072 | |

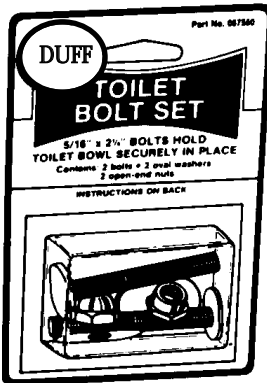

BRASS PLATED Closet bolt Set. (PR)

| SIZE | FIG. NO. | PRICE |
|---------------|----------|-------|
| 1/4 | 42917 | |
| 5/16 | 42918 | |
| 1/4 XTRA LONG | 37307 | |

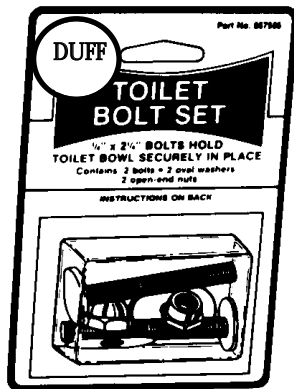

ALL BRASS Closet bolt Set. (PR)

| SIZE | FIG. NO. | PRICE |
|------|----------|-------|
| 1/4 | 15069 | |
| 5/16 | 15071 | |

STOP 
WASTING MONEY
CALL DUFF FIRST!

STOP 
WASTING TIME
CALL DUFF FIRST!



Brass Overflow Tube
1" OD X 10" Long

| FIG. NO. | PRICE |
|----------|-------|
| 18983 | |

PVC Overflow Tube
1" OD X 10" Long

| FIG. NO. | PRICE |
|----------|-------|
| 18057 | |

Duncan Fit All Arm Guide

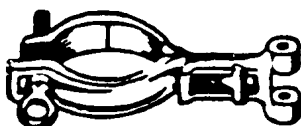

| FIG. NO. | PRICE |
|----------|-------|
| 15064 | |

1/4 x 9 REFILL TUBE



| FIG. NO. | PRICE |
|----------|-------|
| 15054 | |

BOWL WAX

NO SEEP



No Seep 1. Fits 3" and 4" bowls only.

| FIG. NO. | PRICE |
|----------|-------|
| 14644 | |



No Seep 2. Urethane w/ wax. Fits all wax bowls and carriers.

| FIG. NO. | PRICE |
|----------|-------|
| 14646 | |



No Seep 3. Extra thick. Fits 3" to 4" floor and most wall bowls.

| FIG. NO. | PRICE |
|----------|-------|
| 48802 | |



No Seep 4. Urethane wax. 4" lines only - fits floor and most wall bowls.

| FIG. NO. | PRICE |
|----------|-------|
| 47159 | |

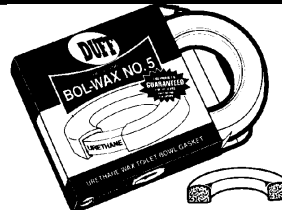

No Seep 5. Urethane and wax. Extra thick - fits 3" and 4" wall or floor bowls.

| FIG. NO. | PRICE |
|----------|-------|
| 14648 | |



No Seep 10. Extra thick wax. For all 3" and 4" floor bowls.

| FIG. NO. | PRICE |
|----------|-------|
| 52330 | |

BOWL WAX



Bowl Wax 1. The standard bowl wax for floor bowls.

| FIG. NO. | PRICE |
|----------|-------|
| 14638 | |



Bowl Wax 5. Urethane and wax. Extra thick. Fits 3 and 4" wall or floor bowls.

| FIG. NO. | PRICE |
|----------|-------|
| 37618 | |



Bowl Wax 6. Urethane and wax. For 2" urinal outlet.

| FIG. NO. | PRICE |
|----------|-------|
| 14640 | |



Sponge Gasket. Wide flange, 1".

| Size | Fig. No. | Price |
|------|----------|-------|
| 9/16 | 14662 | |
| 3/4 | 14665 | |
| 1 | 14666 | |



Sponge Gasket. 1"

| FIG. NO. | PRICE |
|----------|-------|
| 14660 | |

EASY TO INSTALL!

FOR WALL HUNG CLOSETS



Zurn Gasket.

| FIG. NO. | PRICE |
|----------|-------|
| 14651 | |

EASY TO INSTALL

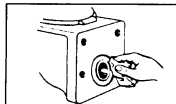

1. Wipe gasket recess in fixture clean with dry cloth.

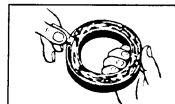

2. Unfold bottom crimp on tube and spread half of adhesive over one side of "Neo-Seal" gasket.



3. Press adhesive-coated side of "Neo-Seal" gasket firmly into gasket recess in fixture being sure it bottoms in groove, and that contact between adhesive and china is maintained.

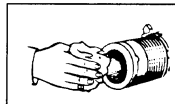

4. Wipe lip of coupling clean and dry.

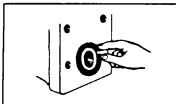

5. Spread other half of tube of adhesive over exposed face of "Neo-Seal" gasket.

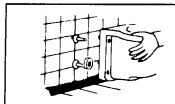

6. Place closet in position over adjustable coupling without delay. Coupling should extend beyond limited wall far enough to compress "Neo-Seal" gasket.



American Standard Urinal Gasket.

| FIG. NO. | PRICE |
|----------|-------|
| 14654 | |



Kohler 2" urinal gasket

| FIG. NO. | PRICE |
|----------|-------|
| 49380 | |



Smith wall hung felt closet gasket.

| FIG. NO. | PRICE |
|----------|-------|
| 22403 | |

FLAPPERS

TRIPLE SEAL

Triple Seal Tank Ball 2 1/2"

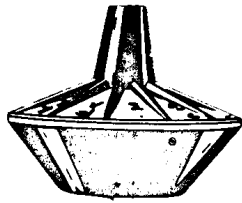

| FIG. NO. | PRICE |
|--------------------------|-------|
| 14900 | |
| 3" Triple Seal Tank Ball | |
| FIG. NO. | PRICE |
| 14901 | |

CRANE FLAPPER BALL

Replacement for Crane Flapper Ball

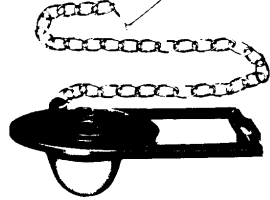

| FIG. NO. | PRICE |
|----------|-------|
| 14634 | |

FLUSH FIX KIT

FLUIDMASTER - Easy installation, corrosion free, eliminates lift wires and guides.



| FIG. NO. | PRICE |
|----------|-------|
| 17720 | |

ELJER 'MUSHROOM' TANK BALL

Eljer Titeseal Replacement Tank Ball



| FIG. NO. | PRICE |
|----------|-------|
| 14902 | |

ELJER TOUCH FLUSH

Replacement for Touch Flush assembly unit. Includes bracket with chain, tankball and screw.

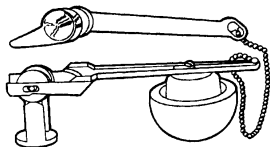

| FIG. NO. | PRICE |
|----------|-------|
| 15012 | |

KOHLER

Kohler Silicone Coated Flapper, with chain and hook.

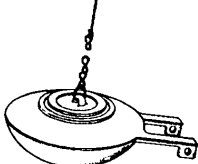

| FIG. NO. | PRICE |
|----------|-------|
| 47133 | |

KORKY FLAPPERS

KORKY PLUS

The Korky Plus combines the superior design of our original Korky, with the innovative technology of a specially formulated compound. It will withstand the purification chemicals found in today's municipal water, as well as the toilet cleaning products that deteriorate standard rubber parts used in the water closet. One piece rubber, fits brass or plastic Douglas Valves with chain and hook.

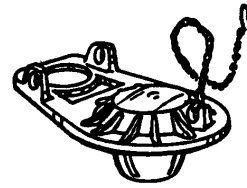

| FIG. NO. | PRICE |
|----------|-------|
| 50614 | |

KORKY LOW PRO

Specially designed for low boy toilets to allow for maximum flush. Will fit most conventional flush valves.

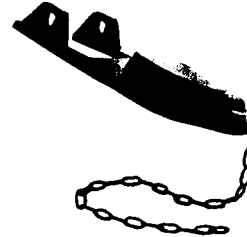

| FIG. NO. | PRICE |
|----------|-------|
| 49249 | |

BLUE FLAPPER

Blue Flapper

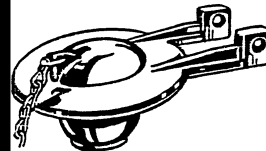

| FIG. NO. | PRICE |
|----------|-------|
| 51477 | |

FITS PLASTIC FLUSH VALVES!

BULL'S EYE SUPER FLAPPER



Withstands harsh water
Fits most flush valves
Replaces flapper of #17720
Snaps directly or adapts to 1" overflow tube

| FIG. NO. | PRICE |
|----------|-------|
| 44996 | |



TOILET REPAIRS



Fluidmaster 400A - Eliminates old-fashioned float balls and rod assemblies that corrode and leak. Easy to install. Permits simple adjustment of water level for most efficient flush. Fits most toilet tanks. Built in code approved backflow preventer.

| FIG. NO. | PRICE |
|----------|-------|
| 14989 | |

ONE PIECE CLOSET VALVE

Sheathed Vertical Float Valve, Rim Diverter, Flusher Fixer Kit, & Vinyl Hoses.

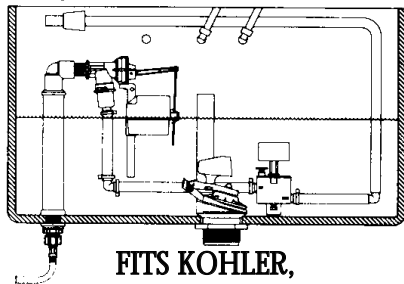

FITS KOHLER, AMERICAN STANDARD, CASE

256 - For the application of a one piece toilet with dry inlet tube system and one-piece toilet. Wet isolation tube.

| FIG. NO. | PRICE |
|----------|-------|
| 50491 | |

Compound Lever - All brass.

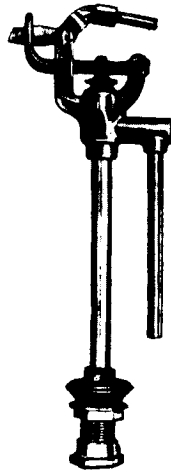

| FIG. NO. | PRICE |
|----------|-------|
| 15002 | |

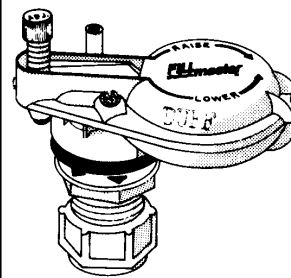

Fillmaster - Adjustable ball cock. No float or rod needed. Completely corrosion proof. *ONE SIZE FITS ALL.* Excellent replacement for one piece closets and other extra low tanks.

| FIG. NO. | PRICE |
|----------|-------|
| 14992 | |



MVB Ballcock - All Brass. Regular shank.

| FIG. NO. | PRICE |
|----------|-------|
| 15001 | |

FLOATS

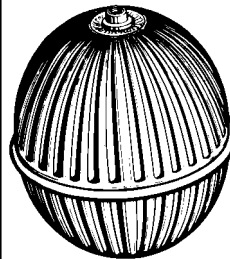

COPPER FLOAT

| FIG. NO. | PRICE |
|----------|-------|
| 15087 | |



PLASTIC FLOAT

| FIG. NO. | PRICE |
|----------|-------|
| 15085 | |

BALL COCK REPAIR

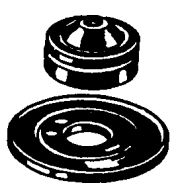

SEAL & FLIPPER ASSEMBLY - Repair kit for Fluidmaster ball-cocks.

| FIG. NO. | PRICE |
|----------|-------|
| 14990 | |



9" UPPER LIFT WIRE

| FIG. NO. | PRICE |
|----------|-------|
| 15063 | |

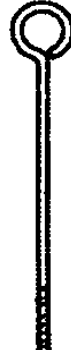

5" LOWER LIFT WIRE

| FIG. NO. | PRICE |
|----------|-------|
| 15061 | |

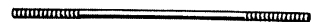

BRASS FLOAT ROD

| FIG. NO. | PRICE |
|----------|-------|
| 8" | 15056 |
| 12" | 15059 |

TOILET REPAIR

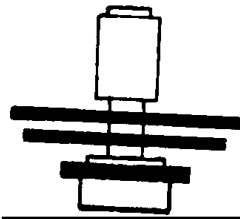

**COAST Ball Cock
Repair Kit**

| FIG. NO. | PRICE |
|----------|-------|
| 15024 | |

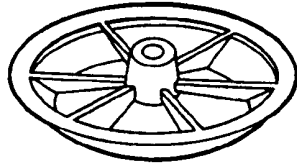

**AMERICAN STANDARD
REPLACEMENT DISCS
Neoprene
Anchored Spud**

Snap-on

Screw-on

| FIG. NO. | PRICE |
|----------|-------|
| 14603 | |

| FIG. NO. | PRICE |
|----------|-------|
| 14601 | |

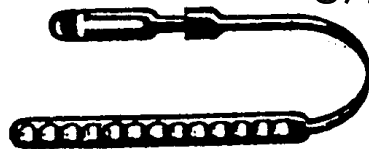

**U/R Replacement
Tank Strap**

| FIG. NO. | PRICE |
|----------|-------|
| 42463 | |

**U/R
Tilt Valve**

| FIG. NO. | PRICE |
|----------|-------|
| 15023 | |

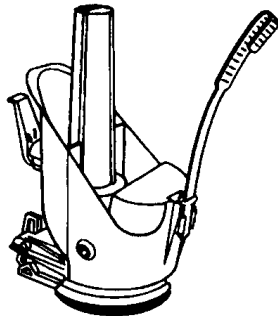

**U/R
Flush Valve
Disk**



| FIG. NO. | PRICE |
|----------|-------|
| 34496 | |

**AMERICAN STANDARD
REPLACEMENT BALLCOCK
PISTON PLUNGER**

| FIG. NO. | PRICE |
|----------|-------|
| 18366 | |



AMERICAN STANDARD FLUSH VALVES

#4 Flushvalve

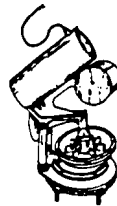

47086-07

| FIG. NO. | PRICE |
|----------|-------|
| 15014 | |

#6 Actuator

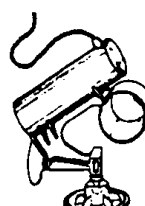

73380-07

| FIG. NO. | PRICE |
|----------|-------|
| 34747 | |

#5 Flushvalve

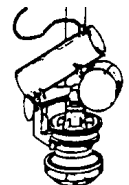

47089-07

| FIG. NO. | PRICE |
|----------|-------|
| 15017 | |

#4 Actuator

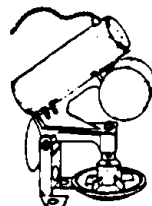

8162-07

| FIG. NO. | PRICE |
|----------|-------|
| 51714 | |

#5 Actuator

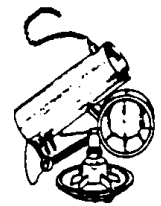

33642-07

| FIG. NO. | PRICE |
|----------|-------|
| 37855 | |

**FAX YOUR
ORDER
TODAY!**

610-279-6299

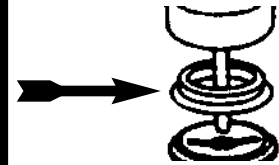

**Seal Only for
American Standard
Flush Valve**

| FIG. NO. | PRICE |
|----------|-------|
| 14608 | |

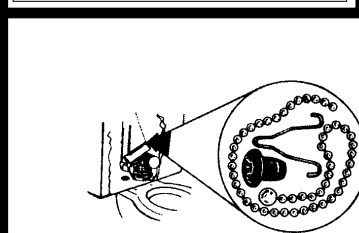

**Repair Kit for
American
Standard
Actuating Units**

| FIG. NO. | PRICE |
|----------|-------|
| 33888 | |

TOILET TANK TRIM

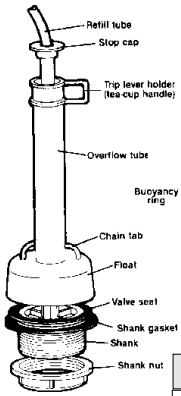

**MANSFIELD
FLUSH VALVE
#210**

| FIG. NO. | PRICE |
|----------|-------|
| 17605 | |

Flush Valve Repair Kit for #210



| FIG. NO. | PRICE |
|----------|-------|
| 42445 | |

Flush Valve Repair Kit for Mansfield #208 & #209

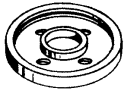

| FIG. NO. | PRICE |
|----------|-------|
| 17606 | |

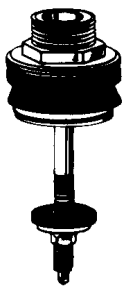

**Kohler Urinal Spud
with Flange**

| FIG. NO. | PRICE |
|----------|-------|
| 44284 | |

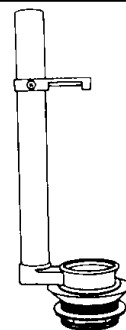

**Brass DOUGLAS Flush
Valve**

| FIG. NO. | PRICE |
|----------|-------|
| 15042 | |

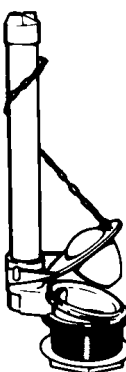

**Plastic DOUGLAS
Flush Valve with Tank
Ball**

| FIG. NO. | PRICE |
|----------|-------|
| 15053 | |



**Closet Offset.
Chrome plated brass
tube complete with
heavy cast nuts and
washer. 2" OD X 6" long - 20
gauge.**

| FIG. NO. | PRICE |
|----------|-------|
| 34995 | |

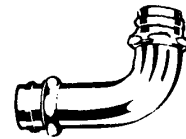

**Chrome Low
Down Tank 90
with
coupling**

| FIG. NO. | PRICE |
|----------|-------|
| 11712 | |



Brass Locknuts

| SIZE | FIG. NO. | PRICE |
|-------|----------|-------|
| 3/4 | 12173 | |
| 1 | 12174 | |
| 1 1/4 | 12175 | |
| 1 1/2 | 12176 | |
| 2 | 12177 | |



**Flanged Spud
Washers**

| SIZE | FIG. NO. | PRICE |
|-----------|----------|-------|
| 1 X 3/4 | 14760 | |
| 1 1/4 | 14763 | |
| 1 1/2 | 14765 | |
| 2 | 14767 | |
| 2 X 1 1/2 | 14773 | |



**Galvanized Friction
Ring**

| SIZE | FIG. NO. | PRICE |
|-------|----------|-------|
| 1 1/4 | 52517 | |
| 1 1/2 | 49394 | |
| 2 | 52519 | |



**Beveled Flush Valve
Washer 3" OD X
2 3/8" High**

| FIG. NO. | PRICE |
|----------|-------|
| 14743 | |

TANK TO BOWL GASKETS



Universal

| FIG. NO. | PRICE |
|----------|-------|
| 14744 | |

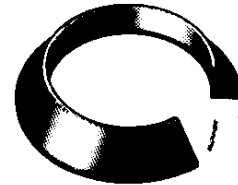

**American
Standard**

| FIG. NO. | PRICE |
|----------|-------|
| 14751 | |

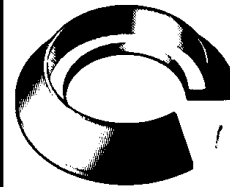

Kohler

| FIG. NO. | PRICE |
|----------|-------|
| 14753 | |



ELJER

| FIG. NO. | PRICE |
|----------|-------|
| 37963 | |

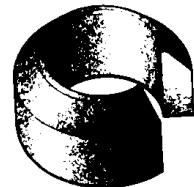

GERBER

| FIG. NO. | PRICE |
|----------|-------|
| 14747 | |

**DON'T SEE WHAT YOU'RE
LOOKING FOR?
CALL US!**

60-275-4453

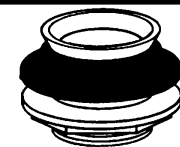

**BRASSS Closet
Spud (with
washer)**

| SIZE | FIG. NO. | PRICE |
|-----------|----------|-------|
| 1 1/4 | 15033 | |
| 1 1/2 | 15035 | |
| 2 | 15037 | |
| 2 x 1 1/4 | 15038 | |
| 2 x 1 1/2 | 15039 | |

URINAL SPUD

| SIZE | FIG. NO. | PRICE |
|-------------|----------|-------|
| 3/4 | 20800 | |
| 1 1/4 x 3/4 | 50485 | |

TANK LEVERS

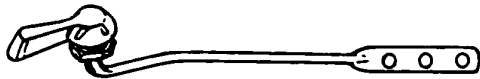

8" metal arm, chrome finish lever, made in the USA, metal nut.

| FIG. NO. | PRICE |
|----------|-------|
| 15030 | |

Deluxe Cast Brass Tank Lever



| FIG. NO. | PRICE |
|----------|-------|
| 15032 | |

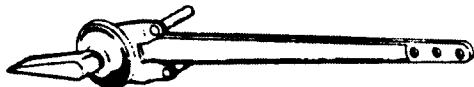

KOHLER K9400 Tank Lever

| FIG. NO. | PRICE |
|----------|-------|
| 15019 | |



KOHLER Side Mount Tank Lever

| FIG. NO. | PRICE |
|----------|-------|
| 52547 | |

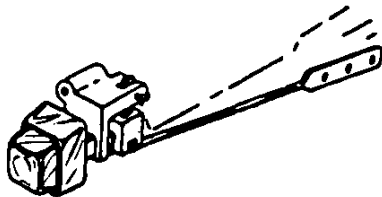

SIDE Push Tank Lever

| FIG. NO. | PRICE |
|----------|-------|
| 50831 | |

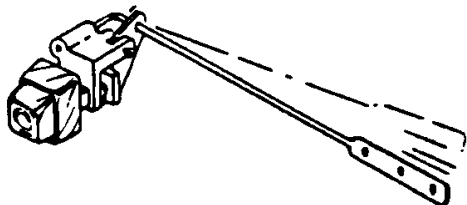

FRONT Push Tank Lever

| FIG. NO. | PRICE |
|----------|-------|
| 52550 | |

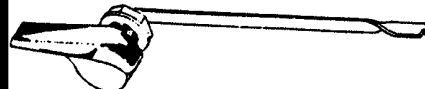

UNIVERSAL-RUNDLE type tank lever.

| FIG. NO. | PRICE |
|----------|-------|
| 52548 | |

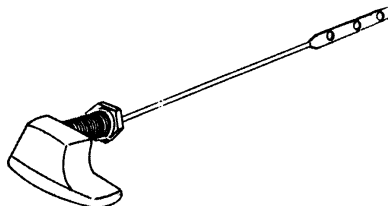

ELJER side mount tank lever

| FIG. NO. | PRICE |
|----------|-------|
| 52545 | |



MANSFIELD 10" Round Brass Offset Tank Lever.

| FIG. NO. | PRICE |
|----------|-------|
| 46855 | |



MANSFIELD White Plastic Tank Lever.

| FIG. NO. | PRICE |
|----------|-------|
| 17833 | |

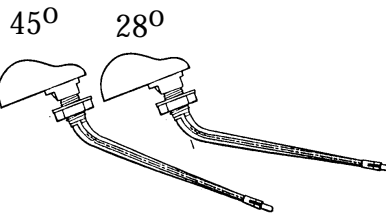

AMERICAN STANDARD 1.6 Cadet Tank Levers

| FIG. NO. | PRICE |
|-----------|-------|
| 45° 51617 | |
| 28° 80608 | |

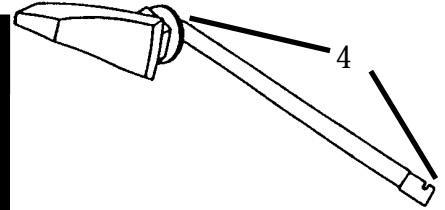

AMERICAN STANDARD 47147.0020A Cadet Tank Lever

| FIG. NO. | PRICE |
|----------|-------|
| 45416 | |

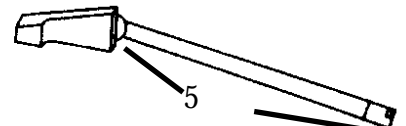

AMERICAN STANDARD Plebe Tank Lever

| FIG. NO. | PRICE |
|----------|-------|
| 43193 | |



FLEXIBLE TANK LEVER 8" long

Bends to fit most tank configurations
Front, side, neoangle
Trims to 4" or 6"

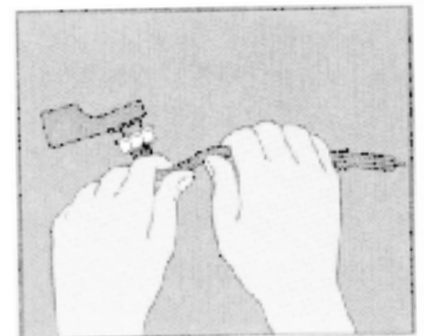

| FIG. NO. | PRICE |
|----------|-------|
| 77624 | |

WE'RE WAITING FOR YOUR CALL! 610-275-4453

TOILET ACCESSORIES

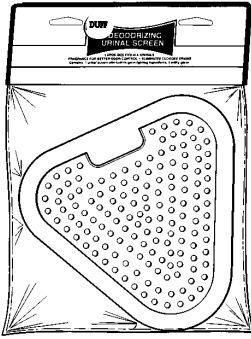

DEODORIZING URINAL SCREEN

Large size - fits all urinals
Eliminate clogged drains.

| FIG. NO. | PRICE |
|----------|-------|
| 52402 | |

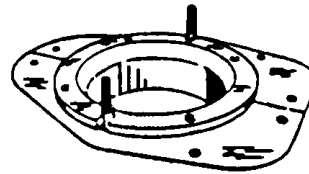

QUICK FLOOR EXPANSION PLATE

Fits under floor flange to eliminate wobble caused by loose connection or rotten floor. Wide base allow screws to reach solid flooring. Closet flange attaches to expansion plate and floor.

| FIG. NO. | PRICE |
|----------|-------|
| 44459 | |

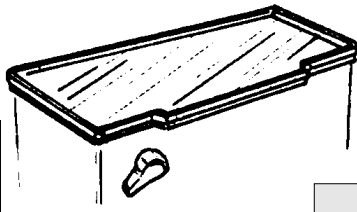

SAFETY TANK COVER

White, adjustable, fits all tanks with OD of 21" X 7 3/8" or Less

| FIG. NO. | PRICE |
|----------|-------|
| 15084 | |

SPACER KIT

PVC closet flange spacer kit

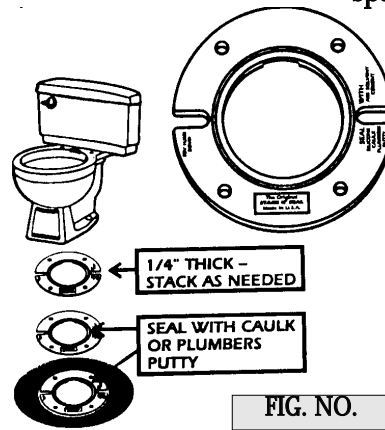

1/4" THICK - STACK AS NEEDED
SEAL WITH CAULK OR PLUMBERS PUTTY

| FIG. NO. | PRICE |
|----------|-------|
| 15824 | |

SPANNER FLANGE

Stops rocking toilet
Repairs broken closet flanges

| FIG. NO. | PRICE |
|----------|-------|
| 7497 | |

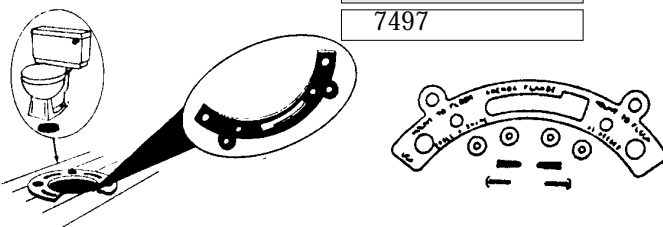

When ordering your spanner flanges, don't forget the closet bolts!

REPLACEMENT PLASTIC TOILET TANK

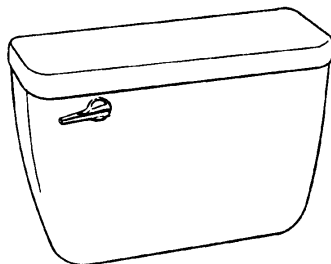

UNBREAKABLE Plastic! Perfect for any replacement need in homes, apartments, housing units, bars, gas stations, parks, camp grounds, schools, industrial plants, etc. Furfished with antisiphon ballcock

| FIG. NO. | PRICE |
|----------|-------|
| 15084 | |



TOILET BOLT CAPS
White round plastic, press on, fits over 7/16" hex nuts. Each.

| FIG. NO. | PRICE |
|----------|-------|
| 14614 | |

MISCELLANEOUS TOILET PARTS

REPLACEMENT PRESSURE TANK PARTS

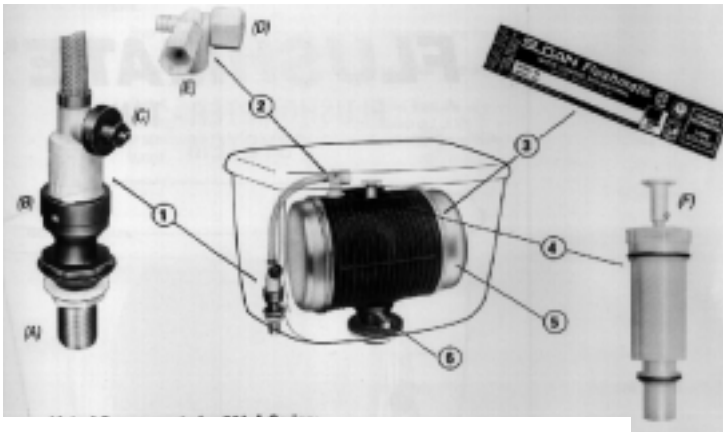

List of Components for 501-A Series:

- | | |
|--|--|
| 1. Lower Supply Group w/Hose BL-100504 | 3. Name Plate w/Serial Number |
| (A) Supply Shank | 4. Flush Valve Cartridge Assembly C-100500 |
| (B) Pressure Regulator w/Back Check | (F) Actuator |
| (C) Relief Valve | 5. Vessel |
| 2. Upper Supply Group BU-100503 | 6. Discharge Extension w/Drain |
| (D) Vacuum Breaker | |
| (E) Air Inducer | |

FLUSHMATE
A Division of Sloan Valve Company

Manufactured under one or more of the following U.S. patents: 3,817,279; 3,817,286; 3,817,486; 3,820,171; 3,840,754; and 4,223,886. Also covered by foreign patents. Patents country and number available upon request.

The Sloan FLUSHMATE Flushometer®-Tank System provides the highest performance capability available today in the ULF (Ultra-Low Fixture) category. That means it consumes less than 1.6 gallons/6 liters of water per flush. It achieves this remarkable performance by using compressed air inside the tank, which creates a *turbo-charged* flushing action for effective bowl cleaning. Compared to other types of low consumption water closets, FLUSHMATE offers many distinctive advantages.

Outstanding FLUSHMATE® Features:

- No Water Leakage Between Flushes
- Positive Bowl Extraction (No Double Flushing)
- Larger Trapway to Eliminate Stoppages
- Stronger Flushing Action Improves Drainline Carry & Leaves Bowl Cleaner
- Non-Sweating Tank Enclosure
- Large Water Spot for Reduced Housekeeping

| # | DESCR | FIG. NO. | PRICE |
|---|--------------------|------------|-------|
| 1 | Flush Vlv Cart Kit | C-100500-K | |
| 2 | Upper Supply Kit | BU100503-K | |
| 3 | Lower Supply Kit | BL100504-K | |

PUSH BUTTON ASSEMBLY (not connected)

| DESCR | CONVEX FIG. NO. | PRICE | CONCAVE FIG. NO. | PRICE |
|---------------|-----------------|-------|------------------|-------|
| Chrome Finish | DP500999-1 | | DP5A0999-1 | |
| Bright Brass | DP500888-1 | | DP5I0888-1 | |

WALL HUNG CLOSET CARRIER HARDWARE

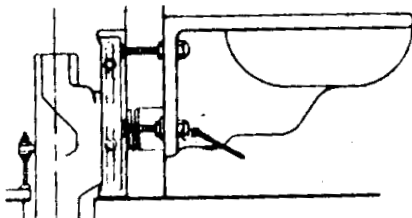

Heavy duty nut CP. 4 to pack.

| FIG. NO. | PRICE |
|----------|-------|
| 36467 | |

FLUSH UP BASEMENT TOILET



Flushes up to sewer or septic tank. No digging up floors. Installs easily, anywhere!

| FIG. NO. | PRICE |
|----------|-------|
| 18802 | |

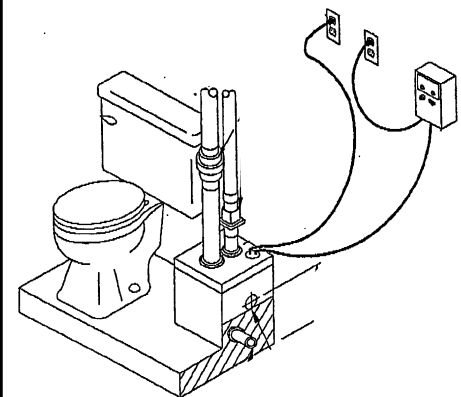

Quik-Jon System

A self-contained waste water/sewage removal system to handle toilet, lavatory shower and bathtub applications. Ideal for any basement or where ever gravity flow is a problem.

DOES NOT INCLUDE TOILET, ALARM OR PIPING

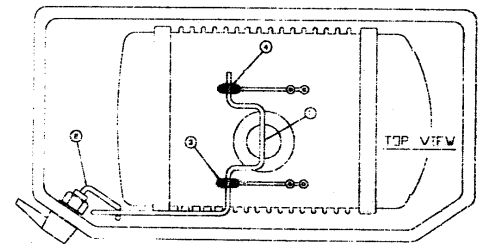

| FIG. NO. | PRICE |
|----------|-------|
| 70797 | |



AMERICAN STANDARD TANK LEVER
738254-0020A

| FIG. NO. | PRICE |
|----------|-------|
| 70648 | |

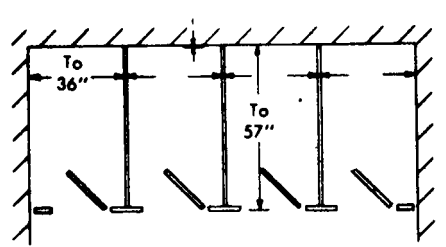
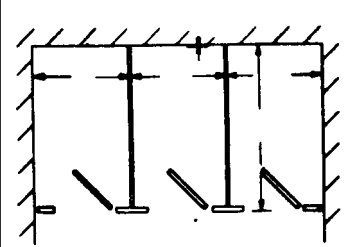
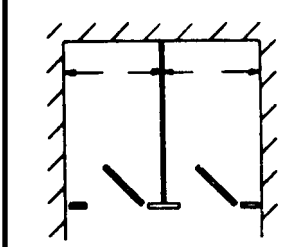
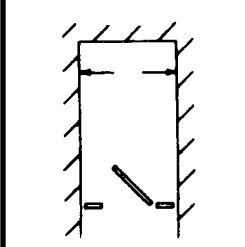
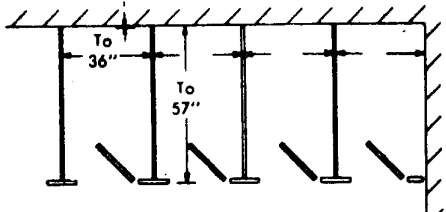
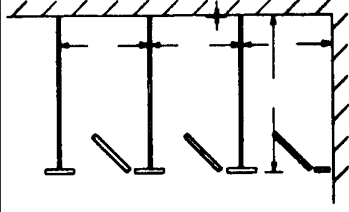
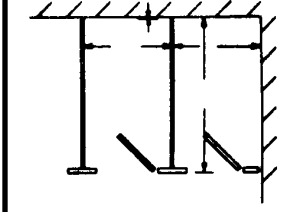
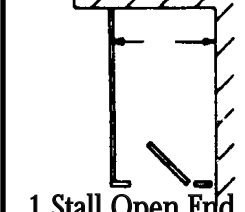
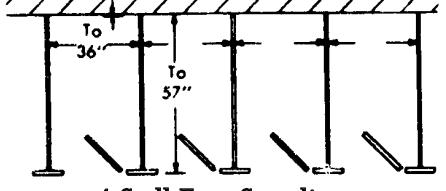
TOILET PARTITIONS

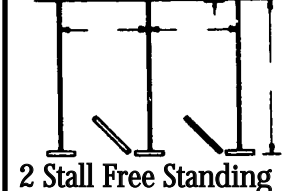
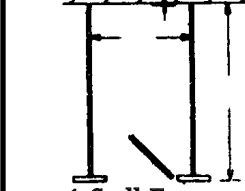
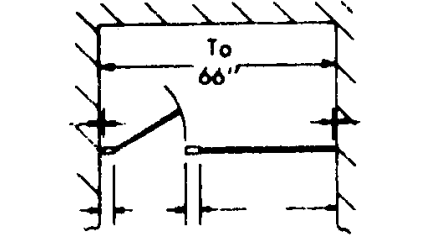
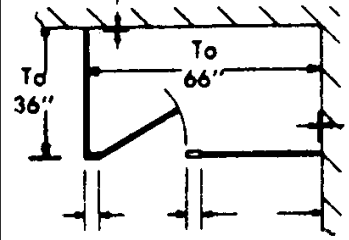
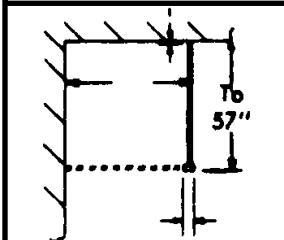
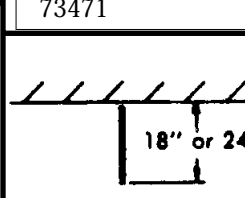
|  <p style="text-align: center;">4 Stall</p> <table border="1" style="width: 100%;"> <thead> <tr> <th>FIG. NO.</th> <th>PRICE</th> </tr> </thead> <tbody> <tr> <td>73458</td> <td></td> </tr> </tbody> </table> | FIG. NO. | PRICE | 73458 | |  <p style="text-align: center;">3 Stall</p> <table border="1" style="width: 100%;"> <thead> <tr> <th>FIG. NO.</th> <th>PRICE</th> </tr> </thead> <tbody> <tr> <td>73459</td> <td></td> </tr> </tbody> </table> | FIG. NO. | PRICE | 73459 | |  <p style="text-align: center;">2 Stall</p> <table border="1" style="width: 100%;"> <thead> <tr> <th>FIG. NO.</th> <th>PRICE</th> </tr> </thead> <tbody> <tr> <td>73460</td> <td></td> </tr> </tbody> </table> | FIG. NO. | PRICE | 73460 | |  <p style="text-align: center;">1 Stall</p> <table border="1" style="width: 100%;"> <thead> <tr> <th>FIG. NO.</th> <th>PRICE</th> </tr> </thead> <tbody> <tr> <td>73461</td> <td></td> </tr> </tbody> </table> | FIG. NO. | PRICE | 73461 | |
|--|----------|-------|-------|--|---|----------|-------|-------|--|--|----------|-------|-------|--|---|----------|-------|-------|--|
| FIG. NO. | PRICE | | | | | | | | | | | | | | | | | | |
| 73458 | | | | | | | | | | | | | | | | | | | |
| FIG. NO. | PRICE | | | | | | | | | | | | | | | | | | |
| 73459 | | | | | | | | | | | | | | | | | | | |
| FIG. NO. | PRICE | | | | | | | | | | | | | | | | | | |
| 73460 | | | | | | | | | | | | | | | | | | | |
| FIG. NO. | PRICE | | | | | | | | | | | | | | | | | | |
| 73461 | | | | | | | | | | | | | | | | | | | |
|  <p style="text-align: center;">4 Stall Open End</p> <table border="1" style="width: 100%;"> <thead> <tr> <th>FIG. NO.</th> <th>PRICE</th> </tr> </thead> <tbody> <tr> <td>73462</td> <td></td> </tr> </tbody> </table> | FIG. NO. | PRICE | 73462 | |  <p style="text-align: center;">3 Stall Open End</p> <table border="1" style="width: 100%;"> <thead> <tr> <th>FIG. NO.</th> <th>PRICE</th> </tr> </thead> <tbody> <tr> <td>73463</td> <td></td> </tr> </tbody> </table> | FIG. NO. | PRICE | 73463 | |  <p style="text-align: center;">2 Stall Open End</p> <table border="1" style="width: 100%;"> <thead> <tr> <th>FIG. NO.</th> <th>PRICE</th> </tr> </thead> <tbody> <tr> <td>73464</td> <td></td> </tr> </tbody> </table> | FIG. NO. | PRICE | 73464 | |  <p style="text-align: center;">1 Stall Open End</p> <table border="1" style="width: 100%;"> <thead> <tr> <th>FIG. NO.</th> <th>PRICE</th> </tr> </thead> <tbody> <tr> <td>73465</td> <td></td> </tr> </tbody> </table> | FIG. NO. | PRICE | 73465 | |
| FIG. NO. | PRICE | | | | | | | | | | | | | | | | | | |
| 73462 | | | | | | | | | | | | | | | | | | | |
| FIG. NO. | PRICE | | | | | | | | | | | | | | | | | | |
| 73463 | | | | | | | | | | | | | | | | | | | |
| FIG. NO. | PRICE | | | | | | | | | | | | | | | | | | |
| 73464 | | | | | | | | | | | | | | | | | | | |
| FIG. NO. | PRICE | | | | | | | | | | | | | | | | | | |
| 73465 | | | | | | | | | | | | | | | | | | | |
|  <p style="text-align: center;">4 Stall Free Standing</p> <table border="1" style="width: 100%;"> <thead> <tr> <th>FIG. NO.</th> <th>PRICE</th> </tr> </thead> <tbody> <tr> <td>73466</td> <td></td> </tr> </tbody> </table> | FIG. NO. | PRICE | 73466 | |  <p style="text-align: center;">3 Stall Free Standing</p> <table border="1" style="width: 100%;"> <thead> <tr> <th>FIG. NO.</th> <th>PRICE</th> </tr> </thead> <tbody> <tr> <td>73467</td> <td></td> </tr> </tbody> </table> | FIG. NO. | PRICE | 73467 | |  <p style="text-align: center;">2 Stall Free Standing</p> <table border="1" style="width: 100%;"> <thead> <tr> <th>FIG. NO.</th> <th>PRICE</th> </tr> </thead> <tbody> <tr> <td>73468</td> <td></td> </tr> </tbody> </table> | FIG. NO. | PRICE | 73468 | |  <p style="text-align: center;">1 Stall Free Standing</p> <table border="1" style="width: 100%;"> <thead> <tr> <th>FIG. NO.</th> <th>PRICE</th> </tr> </thead> <tbody> <tr> <td>73471</td> <td></td> </tr> </tbody> </table> | FIG. NO. | PRICE | 73471 | |
| FIG. NO. | PRICE | | | | | | | | | | | | | | | | | | |
| 73466 | | | | | | | | | | | | | | | | | | | |
| FIG. NO. | PRICE | | | | | | | | | | | | | | | | | | |
| 73467 | | | | | | | | | | | | | | | | | | | |
| FIG. NO. | PRICE | | | | | | | | | | | | | | | | | | |
| 73468 | | | | | | | | | | | | | | | | | | | |
| FIG. NO. | PRICE | | | | | | | | | | | | | | | | | | |
| 73471 | | | | | | | | | | | | | | | | | | | |
|  <p style="text-align: center;">In-Line Partition</p> <table border="1" style="width: 100%;"> <thead> <tr> <th>FIG. NO.</th> <th>PRICE</th> </tr> </thead> <tbody> <tr> <td>73472</td> <td></td> </tr> </tbody> </table> | FIG. NO. | PRICE | 73472 | |  <p style="text-align: center;">Alcove Partition</p> <table border="1" style="width: 100%;"> <thead> <tr> <th>FIG. NO.</th> <th>PRICE</th> </tr> </thead> <tbody> <tr> <td>73473</td> <td></td> </tr> </tbody> </table> | FIG. NO. | PRICE | 73473 | |  <p style="text-align: center;">Sight Screen</p> <table border="1" style="width: 100%;"> <thead> <tr> <th>FIG. NO.</th> <th>PRICE</th> </tr> </thead> <tbody> <tr> <td>73474</td> <td></td> </tr> </tbody> </table> | FIG. NO. | PRICE | 73474 | |  <p style="text-align: center;">Urinal Screen</p> <table border="1" style="width: 100%;"> <thead> <tr> <th>FIG. NO.</th> <th>PRICE</th> </tr> </thead> <tbody> <tr> <td>73475</td> <td></td> </tr> </tbody> </table> | FIG. NO. | PRICE | 73475 | |
| FIG. NO. | PRICE | | | | | | | | | | | | | | | | | | |
| 73472 | | | | | | | | | | | | | | | | | | | |
| FIG. NO. | PRICE | | | | | | | | | | | | | | | | | | |
| 73473 | | | | | | | | | | | | | | | | | | | |
| FIG. NO. | PRICE | | | | | | | | | | | | | | | | | | |
| 73474 | | | | | | | | | | | | | | | | | | | |
| FIG. NO. | PRICE | | | | | | | | | | | | | | | | | | |
| 73475 | | | | | | | | | | | | | | | | | | | |

ALL HARDWARE & FASTENINGS FOR A COMPLETE INSTALLATION ARE INCLUDED

IN A HURRY? FOR PARTITIONS?

Please advise left or right corner,
inswing or outswing door
and exact measurements of room
floor or ceiling support?

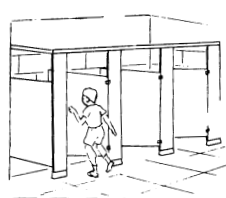

FAX OR MAIL...
SEND US YOUR
LAYOUT!

PARTITION HARDWARE

SLIDE LATCH

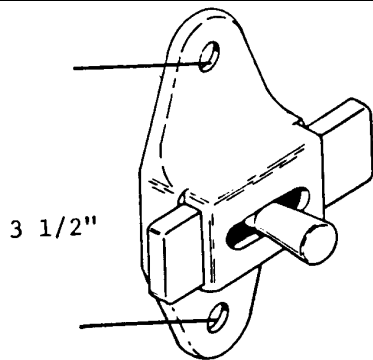

| FIG. NO. | PRICE |
|----------|-------|
| 43844 | |

SLIDE LATCH

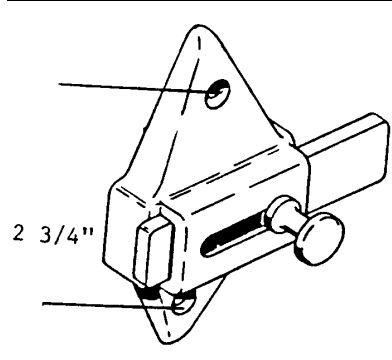

| FIG. NO. | PRICE |
|----------|-------|
| 43842 | |

CONCEALED LATCH

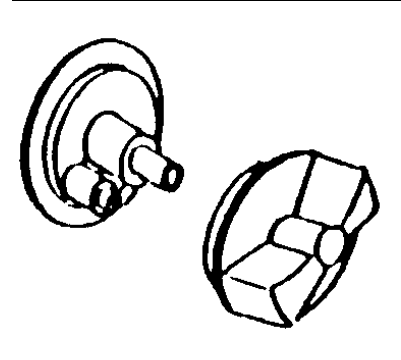

| FIG. NO. | PRICE |
|----------|-------|
| 8253 | |

STRIKER & KEEPER

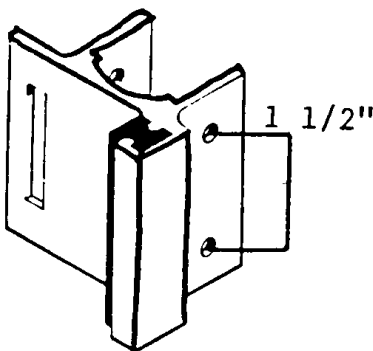

FOR 1 1/4" STEEL PILASTER

| FIG. NO. | PRICE |
|----------|-------|
| 43820 | |

STRIKER & KEEPER FOR ANY TYPE PILASTER

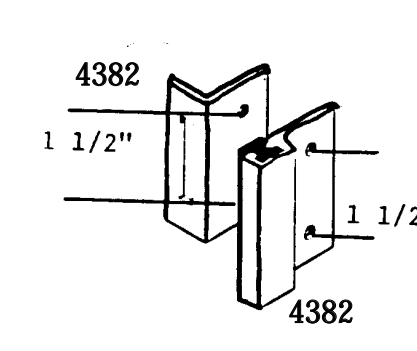

INSWING STRIKER AND KEEPER

| FIG. NO. | PRICE |
|----------|-------|
| 43825 | |
| 43827 | |

ADA CONCEALED LATCH

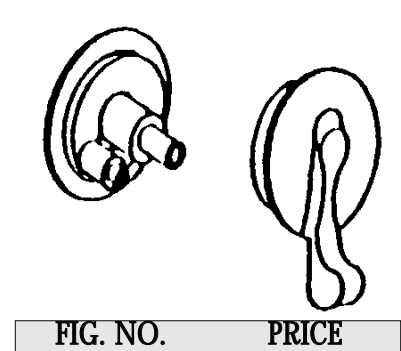

| FIG. NO. | PRICE |
|----------|-------|
| 60738 | |

FITTINGS AND PARTS AVAILABLE ARE TOO NUMEROUS TO CATALOG. PLEASE SEND FOR THE DUFF PARTITION HARDWARE CATALOG!

CONCEALED DOOR LOCK

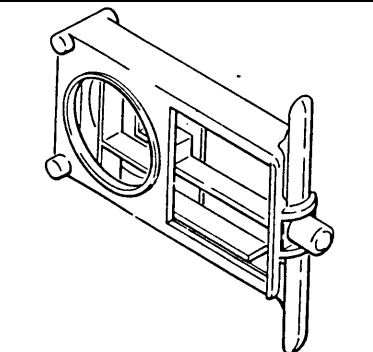

| FIG. NO. | PRICE |
|----------|-------|
| 73476 | |

STRIKER & KEEPER FOR ANY TYPE PILASTER

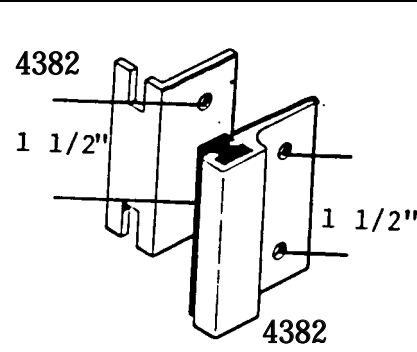

OUTSWING STRIKER AND KEEPER

| FIG. NO. | PRICE |
|----------|-------|
| 43826 | |
| 43827 | |

STRIKER & KEEPER FOR CONCEALED LATCH

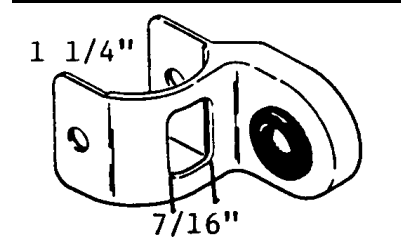

FITS FIG. NO. 8253 & 60738 !

| FIG. NO. | PRICE |
|----------|-------|
| 43823 | |

BOTTOM HINGE BRACKET

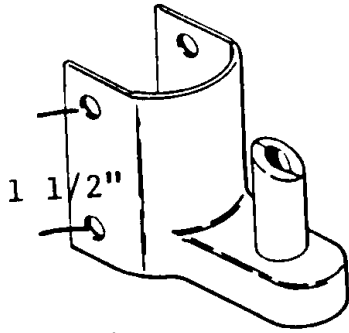

1 1/4"

| FIG. NO. | PRICE |
|----------|-------|
| 43829 | |

PARTITION HARDWARE

TOP HINGE BRACKET

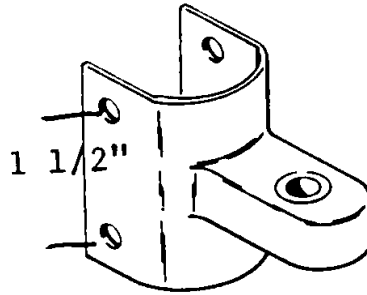

1 1/4"

| FIG. NO. | PRICE |
|----------|-------|
| 43828 | |

SURFACE GRAVITY HINGE

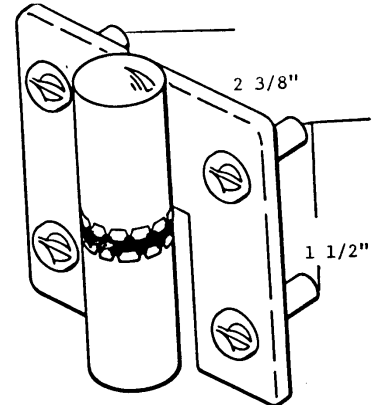

FOR RIGHT HAND OUTSWING OR LEFT HAND INSWING

| FIG. NO. | PRICE |
|----------|-------|
| 43836 | |

FOR RIGHT HAND INSWING OR LEFT HAND OUTSWING

| FIG. NO. | PRICE |
|----------|-------|
| 43837 | |

SQUARE BOTTOM HINGE BRACKET

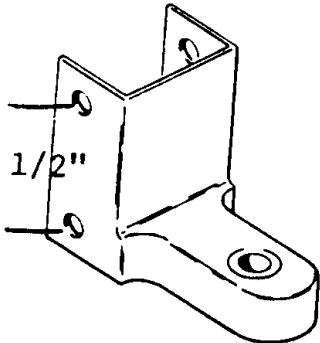

| FIG. NO. | PRICE |
|----------|-------|
| 43833 | |

SQUARE TOP HINGE BRACKET

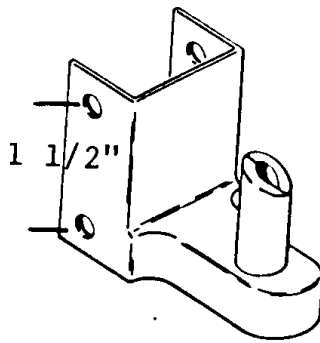

| FIG. NO. | PRICE |
|----------|-------|
| 43830 | |

BUMPER HOOK

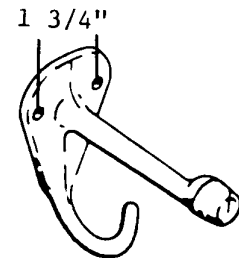

| FIG. NO. | PRICE |
|----------|-------|
| 43848 | |

ONE EAR WALL BRACKET

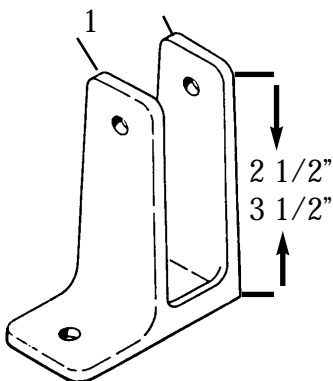

| SIZE | FIG. NO. | PRICE |
|-------|----------|-------|
| 2 1/2 | 43789 | |
| 3 1/2 | 43793 | |

TWO EAR WALL BRACKET

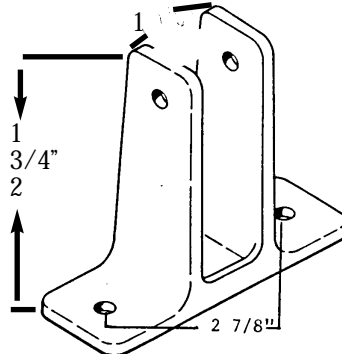

| SIZE | FIG. NO. | PRICE |
|-------|----------|-------|
| 2 1/2 | 43782 | |
| 3 1/2 | 68340 | |
| 1 3/4 | 65878 | |

**FOR ONE WAY
SCREWDRIVER
AND ONE WAY
SCREWS, PLEASE
SEE PAGE 236!**

WASH ROOM ACCESSORIES

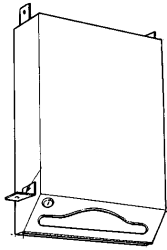

Towel Dispenser

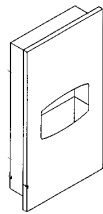

*Towel Dispenser/
Waste Receptacle*

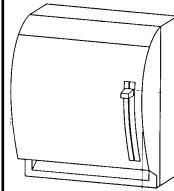

Towel Dispenser

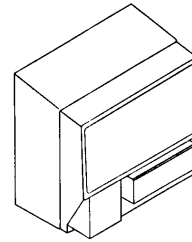

Hand/Hair Dryer

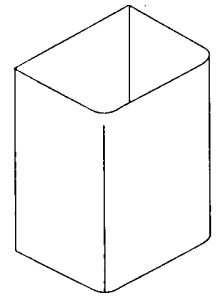

Waste Receptacle

| FIG. NO. | PRICE | FIG. NO. | PRICE | FIG. NO. | PRICE | FIG. NO. | PRICE | FIG. NO. | PRICE |
|----------|-------|----------|-------|----------|-------|----------|-------|----------|-------|
| DB1981 | | DB2298 | | DB2491 | | DB2877 | | DB355 | |

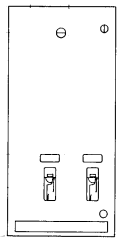

*Sanitary Napkin/ Tampon
Vendor*

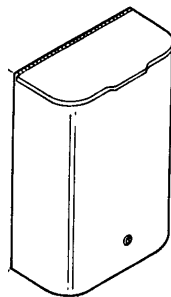

*Sanitary Napkin Disposal
Unit*

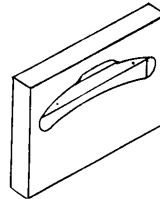

Seat Cover Dispenser

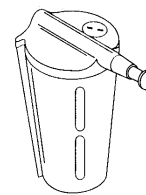

Urn Type Soap Dispenser

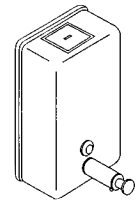

Tank Type Soap Dispenser

| FIG. NO. | PRICE | FIG. NO. | PRICE | FIG. NO. | PRICE | FIG. NO. | PRICE | FIG. NO. | PRICE |
|----------|-------|----------|-------|----------|-------|----------|-------|----------|-------|
| DB426 | | DB4781 | | DB5831 | | DB657 | | 50143 | |

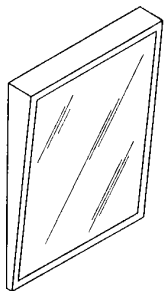

Fixed Tilt Mirror

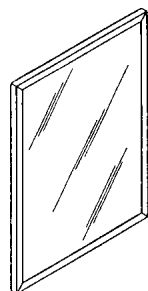

Mirror

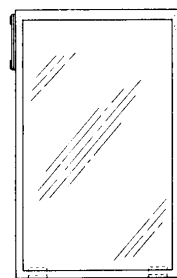

Adjustable Tilt Mirror

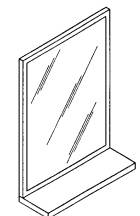
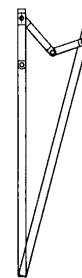

Mirror Shelf

| FIG. NO. | PRICE | FIG. NO. | PRICE | FIG. NO. | PRICE | FIG. NO. | PRICE |
|----------|-------|----------|-------|----------|-------|----------|-------|
| DB740 | | DB781 | | DB782 | | DB7815 | |

WASH ROOM ACCESSORIES

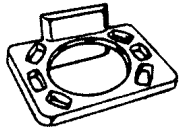

Tumbler and Toothbrush Holder

| FIG. NO. | PRICE |
|----------|-------|
| 8349 | |

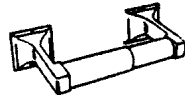

Paper Holder

| FIG. NO. | PRICE |
|----------|-------|
| 8436 | |



Soap Holder

| FIG. NO. | PRICE |
|----------|-------|
| 8370 | |

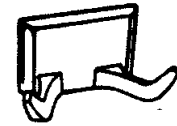

Double Hook

| FIG. NO. | PRICE |
|----------|-------|
| 8461 | |

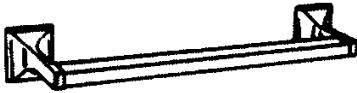

Towel Bar

| SIZE | FIG. NO. | PRICE |
|------|----------|-------|
| 18" | 8497 | |
| 24" | 8506 | |
| 36" | 8514 | |

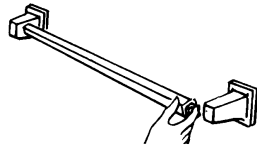

Replacement Towel Bar - 24" with spring ends - cut to length.

| FIG. NO. | PRICE |
|----------|-------|
| 19753 | |

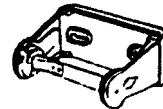

Commercial single paper holder.

| FIG. NO. | PRICE |
|----------|-------|
| 8294 | |

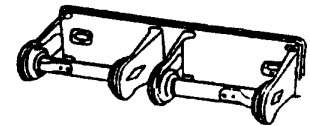

Commercial double paper holder.

| FIG. NO. | PRICE |
|----------|-------|
| 8310 | |

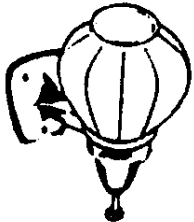

Wall mounted liquid soap dispenser

| FIG. NO. | PRICE |
|----------|-------|
| 46925 | |



One Way Screw Removal Tool - for toilet partition work.

For #8-10 Screws

| FIG. NO. | PRICE |
|----------|-------|
| 43910 | |

For #12-14 Screws

| FIG. NO. | PRICE |
|----------|-------|
| 43911 | |

For #6-8 Screws

| FIG. NO. | PRICE |
|----------|-------|
| 44045 | |



One way screws.

| SIZE | FIG. NO. | PRICE |
|--------|----------|-------|
| 1" | 651-0298 | |
| 1 1/4" | 651-0292 | |
| 1 1/2" | 651-0295 | |

BASIN LAVATORY LEGS

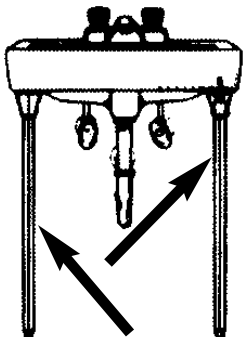

28" Chrome lavatory legs. Universal fit for china, steel, or iron enamel.

| FIG. NO. | PRICE |
|----------|-------|
| 15334 | |



LET DUFF
HELP YOU
COMPLY WITH
ALL YOUR
ADA
REGULATIONS!

610-275-4453

GRAB BARS

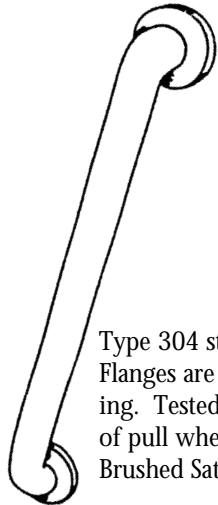

Type 304 stainless steel tubing. Flanges are heliarc welded to tubing. Tested to withstand 1000 LBS of pull when properly installed. Brushed Satin.



LET DUFF HELP YOU MEET YOUR ADA REQUIREMENTS!



| SIZE | FIG. NO. | PRICE |
|------|----------|-------|
| 12" | 17660 | |
| 18" | 45417 | |
| 24" | 17662 | |
| 30" | 45418 | |
| 36" | 17663 | |

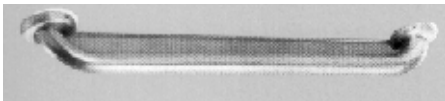

MSA-13 REAR MOUNTED
Grab bar is 1 1/2" diameter x 24" with 1/2" thick closure plate welded to bar. Other sizes are available.
MSA-14 FRONT MOUNTED
Same as above but exposed mount

ALL GRAB BARS ARE AVAILABLE WITH EXPOSED OR CONCEALED FLANGES.

20 DIFFERENT FINISHES AVAILABLE!

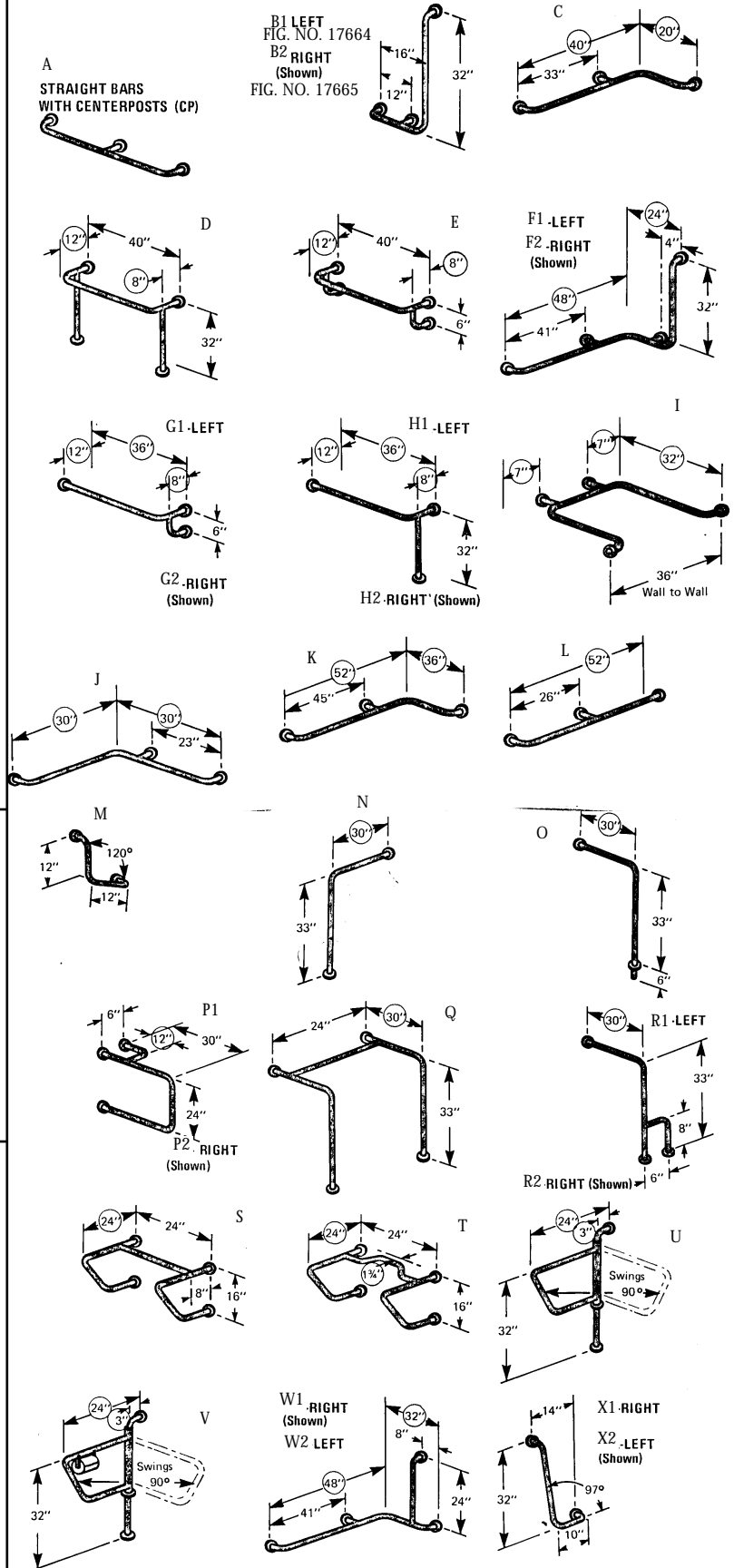

TUB AND SHOWER UNITS

FOR STUD POCKET INSTALLATION

FOR NEW HOMES OR REMODELING

ALL MOLDED FROM VIKRELL MATERIAL

EASY TO CLEAN, LIGHTLY PEBBLED BOTTOM ENHANCES SAFETY AND CONVENIENCE

SNAP TOGETHER CONSTRUCTION ELIMINATES BOLTS, NUTS, WRENCHES AND CAULKING!

10 YEAR CONSUMER - 3 YEAR COMMERCIAL - LIMITED WARRANTY

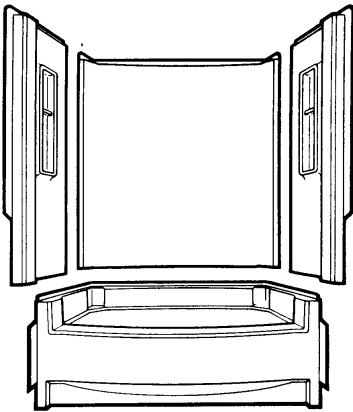

30" TUB/SHOWER
compression molded from Vikrell material. Lightly textured swirl-gloss finish. Easy to clean - never needs waxing. Lightly pebbled slip-resistant bottom enhances user safety and convenience.

4-piece design provides installation flexibility. Components move easily and thru doorways as

narrow as 22". Snap-together feature eliminates need for bolts, nuts, wrenches or caulking. 60" x 30" 120 LB. WHITE. Colors available!

| DESCRIPTION | FIG. NO. | PRICE |
|-------------|----------|-------|
| WHITE | 44841 | |
| COLOR | 44840 | |

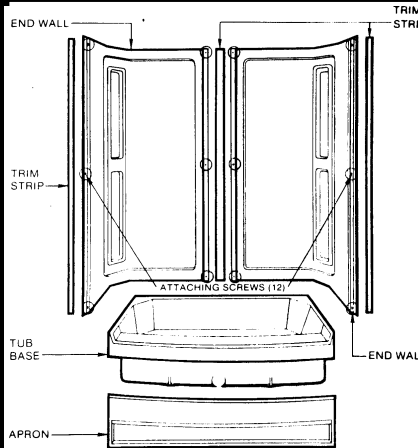

54" TUB/SHOWER
Consists of four compression molded components; 1 54" bathtub with a molded center front drain, two interchangeable wall sections, and a removable tub apron. Made from Vikrell. Molded with a textured surface and slip resistant bottom.

| DESCRIPTION | FIG. NO. | PRICE |
|-------------|----------|-------|
| WHITE | 44850 | |
| COLOR | 44851 | |

TUB ONLY

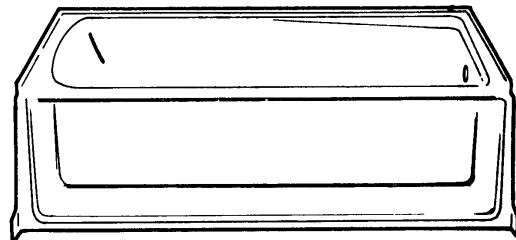

5' TUB ONLY compression molded from Vikrell material. Lightly textured swirl-gloss finish. Easy to clean - never needs waxing.

Lightly pebbled slip-resistant bottom enhances user safety and convenience.

60" x 30 1/2" 56 LB. WHITE.

Colors available!

Shipped with protective liner!

| DESCR | FIG. NO. | PRICE |
|-------|----------|-------|
| WHITE | 44852 | |
| COLOR | 44853 | |

STALL SHOWERS

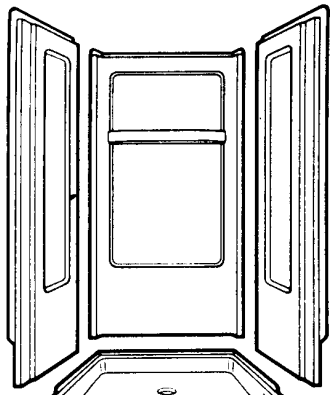

32"x34 1/2"W X 73 1/4"H

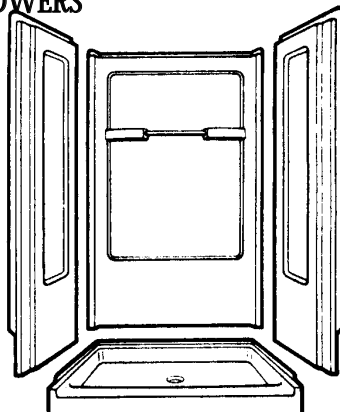

36"x34"W X 73 1/4"H

STALL SHOWER compression molded from Vikrell material. Lightly textured swirl-gloss finish. Easy to clean - never needs waxing. Lightly pebbled slip-resistant bottom enhances user safety and convenience. 4-piece design provides installation flexibility. Components move easily and thru doorways as narrow as 22". Snap-together feature eliminates need for bolts, nuts, wrenches or caulking. 60" x 30" 120 LB. WHITE. Colors available!

| 32" | | | 36" | | |
|-------|----------|-------|-------|----------|-------|
| DESCR | FIG. NO. | PRICE | DESCR | FIG. NO. | PRICE |
| WHITE | 44842 | | WHITE | 44844 | |
| COLOR | 44843 | | COLOR | 44845 | |

TUB & SHOWER

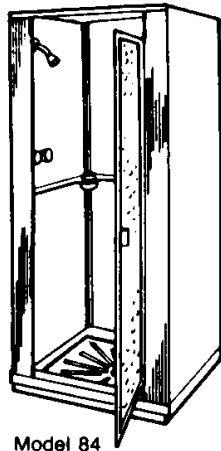

Model 84

FIBERGLASS DURASTALL Shower Stall

| DESCR | ENCL | BASE | FIG NO | PRICE |
|----------|---------|------|--------|-------|
| 32x32x75 | Curtain | Std. | 7891 | |
| 3/8" | Curtain | Ext. | 7893 | |
| 32x32x78 | Door | Std. | 7898 | |
| 3/8" | Door | Ext. | 7904 | |
| 32x32x75 | Curtain | Std. | 7906 | |
| 3/8" | Door | Std. | 7914 | |
| 32x32x78 | Curtain | Std. | 7925 | |

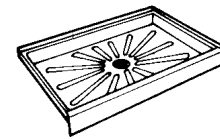

32" SQUARE TILE BASE with PVC

drain assembly and seal single threshold

| FIG. NO. | PRICE |
|----------|-------|
| 8040 | |

RECTANGULAR FIBERGLASS BASE

with PVC drain assembly and seal. Single threshold

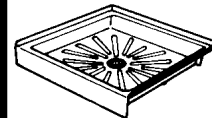

| COLOR | SIZE | FIG. NO. | PRICE |
|-------|-------|----------|-------|
| White | 32X48 | 29766 | |
| White | 32X60 | 29538 | |

DURAWALL CO/POLY BATHTUB WALLS

| COLOR | HGHT | FIG NO | PRICE |
|-------|------|--------|-------|
| White | 58" | 8066 | |
| Bone | 58" | 8102 | |

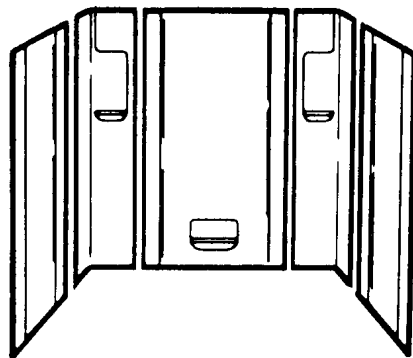
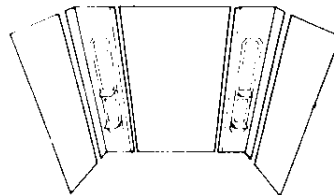

| FIG. NO. | PRICE |
|----------|-------|
| 14690 | |

Fiberglass Tubwall Enclosure - for tub size 57" to 62" wide, 29" to 32" deep. 5-piece compression-molded fiberglass nit with high glass, smooth surface. Kit includes: one back panel with molded-in soap dish, two right angle corner panels with molded-in shampoo shelves, two flat side panels, two apron strips, pressure-sensitive tape applied to all outer edges, two tubes of adhesive, one tube of caulk, and complete installation instructions.

NEO-ANGLE
White corner angled threshold base with PVC drain assembly and seal.

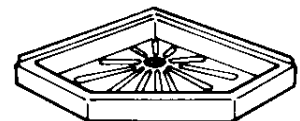

| SIZE | FIG. NO. | PRICE |
|-------|----------|-------|
| 36X36 | 29539 | |
| 36X38 | 8058 | |

Fiberglass Tubwall Enclosure - for tub size 30" x 60" or smaller. 3-piece compression-molded fiberglass unit with high glass, smooth surface. Kit includes: one back panel with molded-in soap dish, two end panels, factory installed pressure-sensitive tape, two tubes of adhesive, one tube of caulk, and complete installation instructions.

| FIG. NO. | PRICE |
|----------|-------|
| 14682 | |

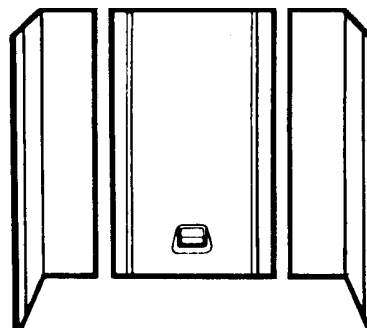

DRAIN GASKET

Seals drain pipe with flexible gasket

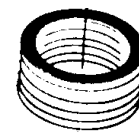

| | FIG. NO. | PRICE |
|--------------|----------|-------|
| 2" IP or PVC | 49308 | |
| 2" Copper | 49110 | |

TUB & SHOWER

FIBERGLASS TUB & SHOWER WALLS FOR REMODELING
 20 YEAR LIMITED WARRANTY
 WATER & MOLD RESISTANT - EASY TO INSTALL
 COLORS AVAILABLE!

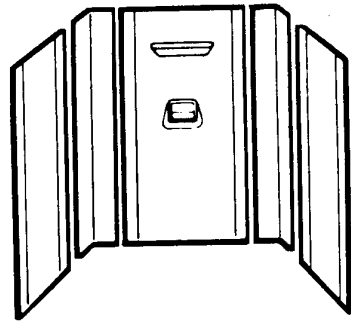

Fiberglass showerwall enclosure. For base 36"x36" or smaller. 5 piece compression-molded fiberglass unit with high gloss, smooth surface. 5 piece unit with soap dish and shampoo shelf. WHITE.

| FIG. NO. | PRICE |
|----------|-------|
| 14684 | |

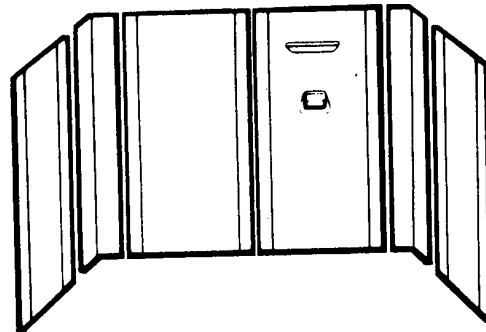

Fiberglass showerwall enclosure. For base 30"x36" up to 36"x60". 6 piece unit with soap dish and shampoo shelf. WHITE.

| FIG. NO. | PRICE |
|----------|-------|
| 14688 | |

SHOWER TOWER

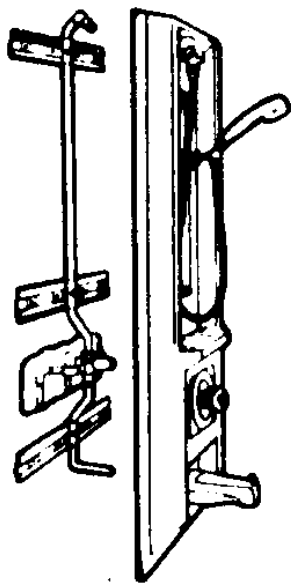

One water tested copper plumbing tree with blender valve and threaded connections for water hook-up, three special screws and anchors, one press-molded fiberglass housing with foam strips installed on back of sides for water tightness and all materials necessary for installation. Copper tubing outlet and tub spout included. Includes either a standard shower head or

hand held shower assembly with glide rail pre-installed.

GLASS TUB ENCLOSURE.

Tempered glass tub door. 5' (57-59 1/2"). Call for other sizes and styles!

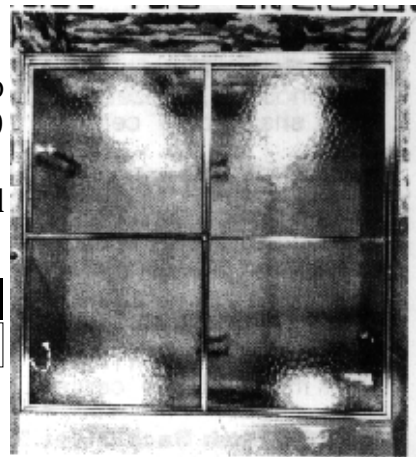

| FIG. NO. | PRICE |
|----------|-------|
| 17796 | |

CALL FOR OTHER SIZES AND STYLES!

ORDER BY MODEL NUMBER!

GLASS SHOWER DOOR

Tempered glass 24-24 1/2".

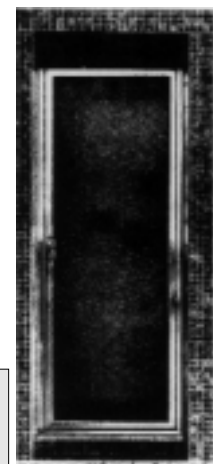

CALL FOR OTHER SIZES AND STYLES!

| FIG. NO. | PRICE |
|----------|-------|
| 66162 | |

TM1-S



TM2-H



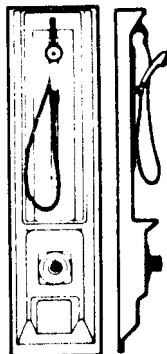
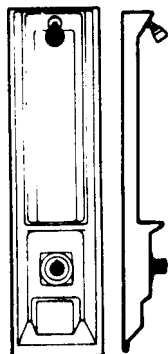
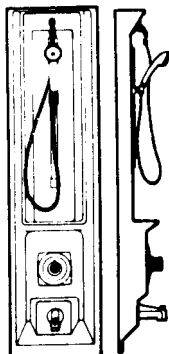
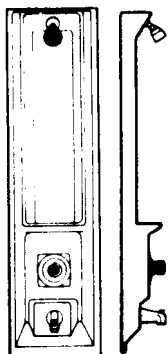

SM1-S

SM2-H





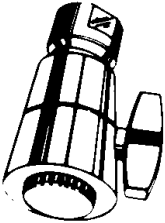
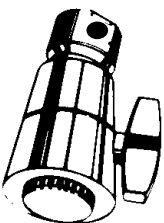
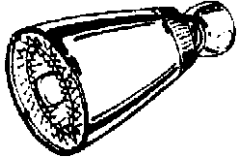

SHOWER HEADS

|  <p>Chrome plated, solid brass flow control shower head.</p> <table border="1"> <tr> <th>FIG. NO.</th> <th>PRICE</th> </tr> <tr> <td>14832</td> <td></td> </tr> </table> | FIG. NO. | PRICE | 14832 | |  <p>Chrome plated brass flow control shower head with pilfer proof feature (set screw).</p> <table border="1"> <tr> <th>FIG. NO.</th> <th>PRICE</th> </tr> <tr> <td>14833</td> <td></td> </tr> </table> | FIG. NO. | PRICE | 14833 | |  <p>Vandal-Proof institutional shower head</p> <table border="1"> <tr> <th>FIG. NO.</th> <th>PRICE</th> </tr> <tr> <td>14830</td> <td></td> </tr> </table> | FIG. NO. | PRICE | 14830 | |
|---|----------|-------|-------|--|--|----------|-------|-------|--|---|----------|-------|-------|--|
| FIG. NO. | PRICE | | | | | | | | | | | | | |
| 14832 | | | | | | | | | | | | | | |
| FIG. NO. | PRICE | | | | | | | | | | | | | |
| 14833 | | | | | | | | | | | | | | |
| FIG. NO. | PRICE | | | | | | | | | | | | | |
| 14830 | | | | | | | | | | | | | | |

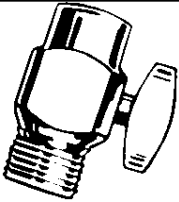
|  <p>SPEAKMAN small shower head (2 1/4") chrome plated brass.</p> <table border="1"> <tr> <th>FIG. NO.</th> <th>PRICE</th> </tr> <tr> <td>17618</td> <td></td> </tr> </table> | FIG. NO. | PRICE | 17618 | |  <p>SPEAKMAN medium shower head (2 3/4") chrome plated brass</p> <table border="1"> <tr> <th>FIG. NO.</th> <th>PRICE</th> </tr> <tr> <td>17617</td> <td></td> </tr> </table> | FIG. NO. | PRICE | 17617 | |  <p>MOENflo deluxe head, arm and flange, vandal resistant.</p> <table border="1"> <tr> <th>FIG. NO.</th> <th>PRICE</th> </tr> <tr> <td>47654</td> <td></td> </tr> </table> | FIG. NO. | PRICE | 47654 | |  <p>MOENflo head, arm and flange.</p> <table border="1"> <tr> <th>FIG. NO.</th> <th>PRICE</th> </tr> <tr> <td>47022</td> <td></td> </tr> </table> | FIG. NO. | PRICE | 47022 | |
|---|----------|-------|-------|--|---|----------|-------|-------|--|--|----------|-------|-------|--|--|----------|-------|-------|--|
| FIG. NO. | PRICE | | | | | | | | | | | | | | | | | | |
| 17618 | | | | | | | | | | | | | | | | | | | |
| FIG. NO. | PRICE | | | | | | | | | | | | | | | | | | |
| 17617 | | | | | | | | | | | | | | | | | | | |
| FIG. NO. | PRICE | | | | | | | | | | | | | | | | | | |
| 47654 | | | | | | | | | | | | | | | | | | | |
| FIG. NO. | PRICE | | | | | | | | | | | | | | | | | | |
| 47022 | | | | | | | | | | | | | | | | | | | |

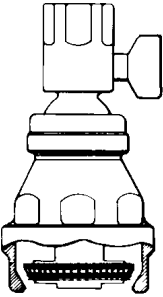
|  <p>Adjustable shower head, chrome plated brass.</p> <table border="1"> <tr> <th>FIG. NO.</th> <th>PRICE</th> </tr> <tr> <td>38920</td> <td></td> </tr> </table> | FIG. NO. | PRICE | 38920 | |  <p>Adjustable shower head with pilfer proof feature (set screw), chrome plated brass.</p> <table border="1"> <tr> <th>FIG. NO.</th> <th>PRICE</th> </tr> <tr> <td>14828</td> <td></td> </tr> </table> | FIG. NO. | PRICE | 14828 | |  <p>2" ball joint shower head - chrome plated</p> <table border="1"> <tr> <th>FIG. NO.</th> <th>PRICE</th> </tr> <tr> <td>14823</td> <td></td> </tr> </table> | FIG. NO. | PRICE | 14823 | |
|--|----------|-------|-------|--|--|----------|-------|-------|--|---|----------|-------|-------|--|
| FIG. NO. | PRICE | | | | | | | | | | | | | |
| 38920 | | | | | | | | | | | | | | |
| FIG. NO. | PRICE | | | | | | | | | | | | | |
| 14828 | | | | | | | | | | | | | | |
| FIG. NO. | PRICE | | | | | | | | | | | | | |
| 14823 | | | | | | | | | | | | | | |

|  <p>Shower volume control valve.</p> <table border="1"> <tr> <th>FIG. NO.</th> <th>PRICE</th> </tr> <tr> <td>14838</td> <td></td> </tr> </table> | FIG. NO. | PRICE | 14838 | |  <p>GALAXY MASSAGE Adjustable shower head acrylic body, chrome plated.</p> <table border="1"> <tr> <th>FIG. NO.</th> <th>PRICE</th> </tr> <tr> <td>47740</td> <td></td> </tr> </table> | FIG. NO. | PRICE | 47740 | |  <p>2" multi-spray (adjustable) showerhead. Chrome plated brass.</p> <table border="1"> <tr> <th>FIG. NO.</th> <th>PRICE</th> </tr> <tr> <td>14824</td> <td></td> </tr> </table> | FIG. NO. | PRICE | 14824 | |  <p>SLOAN Act-O-Matic shower head. No clogging, fingertip volume control, no dripping, vandal proof model.</p> <table border="1"> <tr> <th>FIG. NO.</th> <th>PRICE</th> </tr> <tr> <td>54277</td> <td></td> </tr> </table> | FIG. NO. | PRICE | 54277 | |
|---|----------|-------|-------|--|---|----------|-------|-------|--|---|----------|-------|-------|--|---|----------|-------|-------|--|
| FIG. NO. | PRICE | | | | | | | | | | | | | | | | | | |
| 14838 | | | | | | | | | | | | | | | | | | | |
| FIG. NO. | PRICE | | | | | | | | | | | | | | | | | | |
| 47740 | | | | | | | | | | | | | | | | | | | |
| FIG. NO. | PRICE | | | | | | | | | | | | | | | | | | |
| 14824 | | | | | | | | | | | | | | | | | | | |
| FIG. NO. | PRICE | | | | | | | | | | | | | | | | | | |
| 54277 | | | | | | | | | | | | | | | | | | | |

|  <p>HYDRA MASSAGE SHOWER HEAD ☼Deluxe Chrome ☼Removable flow restrictor to 2.50 GPM at 80 PSI ☼3 Spray functions- Pulsating, Massage, Regular Spray or Combination Spray!</p> <table border="1"> <tr> <th>FIG. NO.</th> <th>PRICE</th> </tr> <tr> <td>78827</td> <td></td> </tr> </table> | FIG. NO. | PRICE | 78827 | |  <p>3 1/2" RAIN HEAD. Chrome plated with ball joint.</p> <table border="1"> <tr> <th>FIG. NO.</th> <th>PRICE</th> </tr> <tr> <td>14835</td> <td></td> </tr> </table> | FIG. NO. | PRICE | 14835 | |
|--|----------|-------|-------|--|--|----------|-------|-------|--|
| FIG. NO. | PRICE | | | | | | | | |
| 78827 | | | | | | | | | |
| FIG. NO. | PRICE | | | | | | | | |
| 14835 | | | | | | | | | |

SHOWER ACCESSORIES

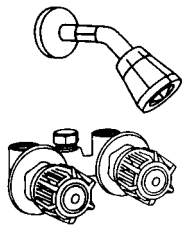

Stall Shower Valve.

3 3/8" centers.

| FIG. NO. | PRICE |
|----------|-------|
| 14768 | |

2 GPM Flow Restrictor.
3 variable orifices. Slips into threaded collar of shower head, cone pointing up. 2 GPM @ 15 to 125 PSI.



| FIG. NO. | PRICE |
|----------|-------|
| 14837 | |

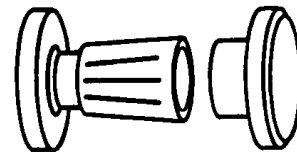

Jiffy Shower Rod Flanges. Chrome plated, easy adjustment for tool free installation of shower rod.

| FIG. NO. | PRICE |
|----------|-------|
| 14761 | |



Shower Arm

| SIZE | FIG. NO. | PRICE |
|---------|----------|-------|
| 1/2 X 6 | 14739 | |
| 1/2 X 8 | 51253 | |

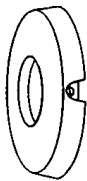

Deluxe shower arm escutcheon with set screw.

| FIG. NO. | PRICE |
|----------|-------|
| 14741 | |

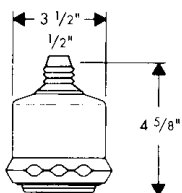

CLUBMASTER SHOWERHEAD

3 spray modes: full shower, soft aerated, and pulsating massage. Features Quick-Clean self-cleaning system. Best yet for club and locker applications!

| FIG. NO. | PRICE |
|----------|-------|
| 64924 | |

COUNTRY CLUB SHOWERHEAD



WITH MOUNTING ASSEMBLY!

12" DIAMETER

A unique, self-contained reservoir neutralizes outlet water pressure and lets water fall rain-gentle through more than 450 openings in a pattern large enough to cover the entire body. Ideal for a locker room application. Installs to standard 1/2" piping with Fig. No. 52566.

| FIG. NO. | PRICE |
|----------|-------|
| 52564 | |

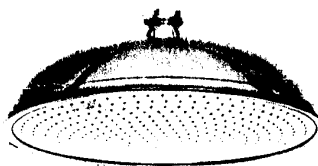

CHROME - A unique, self-contained reservoir neutralizes outlet water pressure and lets water fall rain-gentle through more than 450 openings

in a pattern large enough to cover the entire body. Ideal for a locker room application. Installs to standard 1/2" piping with Fig. No. 52566. **12" DIAMETER.**

| FIG. NO. | PRICE |
|----------|-------|
| 52565 | |

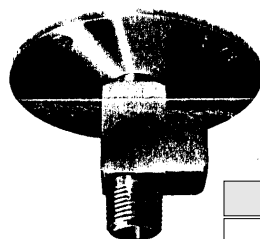

Locker Room Shower Head Pipe Adapter. Install Fig. No. 52565 quickly and easily.

| FIG. NO. | PRICE |
|----------|-------|
| 52566 | |

PREVENT WATER DAMAGE!

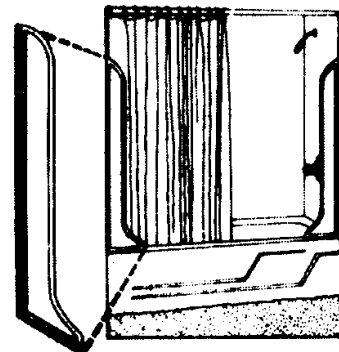

Shower Mate. Keeps water from escaping around ends of shower curtain. Shelf adhesive strips, white polystyrene.

| FIG. NO. | PRICE |
|----------|-------|
| 19216 | |

SHOWER ACCESSORIES



PR CP Shower Rod Flanges

| FIG. NO. | PRICE |
|----------|-------|
| 14762 | |

FAX YOUR ORDER AT 610-279-6299!

Curtain Pins. Nickel Plated



| FIG. NO. | PRICE |
|----------|-------|
| 14766 | |

PR Jumbo Shower Bar Flange. Chrome plated.

| FIG. NO. | PRICE |
|----------|-------|
| 14764 | |

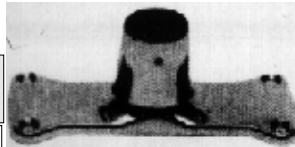

5 FT Aluminum Shower Rod With Flanges

| FIG. NO. | PRICE |
|----------|-------|
| 14749 | |



Aluminum Shower Corner Rod with Flanges

| FIG. NO. | PRICE |
|----------|-------|
| 14752 | |

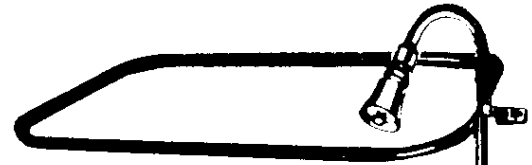

Add-A-Shower with bathcock. Chrome Plated. FOR TUB WITH LEGS.

| FIG. NO. | PRICE |
|----------|-------|
| 14724 | |

Replacement shower valve only

| FIG. NO. | PRICE |
|----------|-------|
| 14727 | |

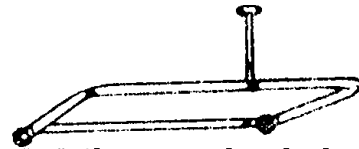
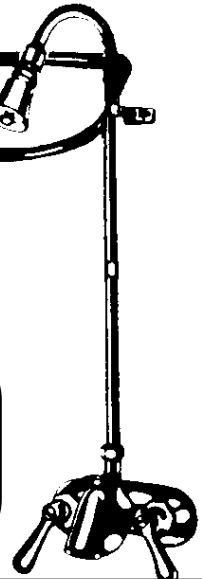

5FT "D" Shower Rod with Flange

| FIG. NO. | PRICE |
|----------|-------|
| 14756 | |

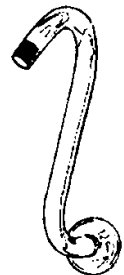

Shower Head Extension. Raise the level of shower head. Chrome plated brass pipe. 1/2" M X 1/2" M.

| FIG. NO. | PRICE |
|----------|-------|
| 52285 | |

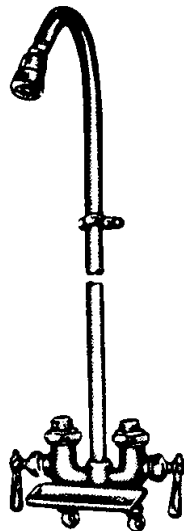

Utility Shower. Rough brass finish. Wall-Mounted.

| FIG. NO. | PRICE |
|----------|-------|
| 38724 | |



Ceiling Support. Chrome plated. 24".

| FIG. NO. | PRICE |
|----------|-------|
| 52285 | |

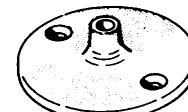

Ceiling Support Flange. Regular 1/8" Thread. With mounting screws.

| FIG. NO. | PRICE |
|----------|-------|
| 14737 | |

24" Ceiling Support Rod.

| FIG. NO. | PRICE |
|----------|-------|
| 14730 | |

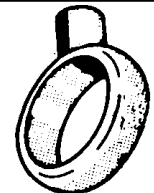

1" Loop Ceiling Support

| FIG. NO. | PRICE |
|----------|-------|
| 14732 | |

3/4" Loop Ceiling Support

| FIG. NO. | PRICE |
|----------|-------|
| 14734 | |

HAND HELD SHOWER

HAND HELD SHOWER HEADS

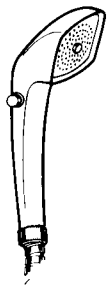

HAND HELD SHOWER HEAD - With Shutoff

| FIG. NO. | PRICE |
|----------|-------|
| 15365 | |

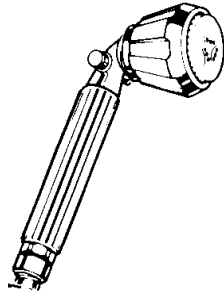

SHOWER ALL MASSAGE - Chrome Plated ABS with acrylic Head and shutoff

| FIG. NO. | PRICE |
|----------|-------|
| 15362 | |

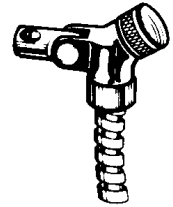

SWIVEL BASE - Chrome Plated Metal

| FIG. NO. | PRICE |
|----------|-------|
| 15368 | |

HAND HELD SHOWER ACCESSORIES

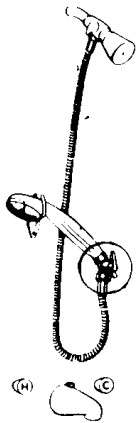

Diverter Valve - Lever handle, chrome plated brass.

| FIG. NO. | PRICE |
|----------|-------|
| 15359 | |

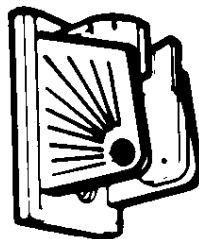

Wall Holder - Glues or screws to wall!

| FIG. NO. | PRICE |
|----------|-------|
| 15361 | |



Wall Holder - with swivel

| FIG. NO. | PRICE |
|----------|-------|
| 15366 | |



24" slide bar, swivel connector, special non-kink hose

| FIG. NO. | PRICE |
|----------|-------|
| 43562 | |

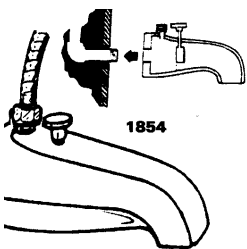

DIVERTER SPOUT
Easy installation diverter spout

| FIG. NO. | PRICE |
|----------|-------|
| 44871 | |

DON'T FORGET YOUR REPLACEMENT HOSE!

DIVERTER ADAPTER

TUB SPOUT DIVERTER ADAPTER

| FIG. NO. | PRICE |
|----------|-------|
| 87613 | |

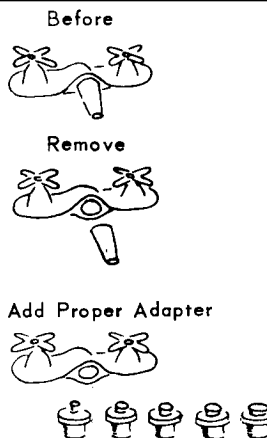

HANDHELD SHOWER REPLACEMENT HOSE

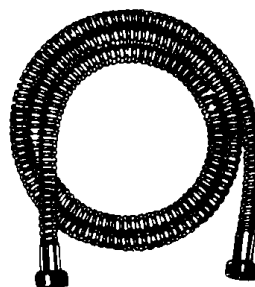

STAINLESS STEEL
Replacement Hose

SPECIFY YOUR LENGTH!

AVAILABLE IN WHITE VINYL

| SIZE | FIG. NO. | PRICE |
|------|----------|-------|
| 60" | 15354 | |
| 71" | 15355 | |
| 96" | 15358 | |

TUB SPOUTS

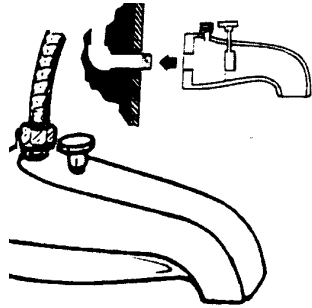

Diverter with 1/2" MPT top shower

| FIG. NO. | PRICE |
|----------|-------|
| 44871 | |

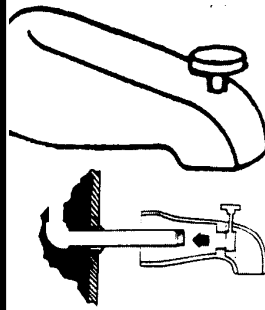

Diverter with 1/2" FPT at the nose

| FIG. NO. | PRICE |
|----------|-------|
| 47332 | |

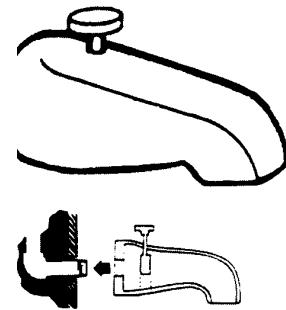

Diverter with 3/4" x 1/2" bushing at back

| FIG. NO. | PRICE |
|----------|-------|
| 14770 | |

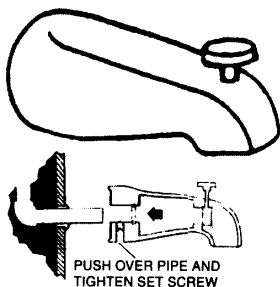

Slip-type Diverter

| FIG. NO. | PRICE |
|----------|-------|
| 43543 | |

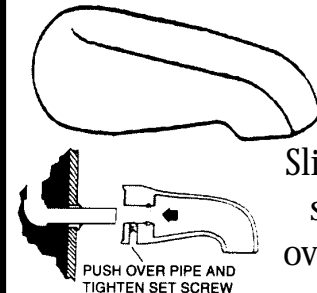

Slip-type spout over rim.

| FIG. NO. | PRICE |
|----------|-------|
| 47333 | |

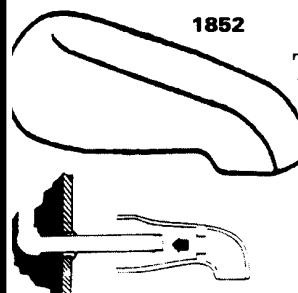

1852 Female Tub Spout

| FIG. NO. | PRICE |
|----------|-------|
| 14769 | |

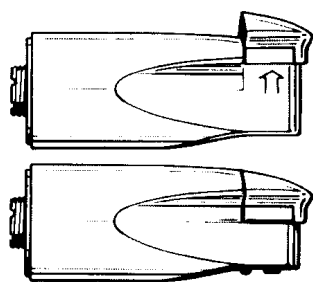

Diverter with 3/4" x 1/2" thread at back.

| FIG. NO. | PRICE |
|----------|-------|
| 47334 | |

TRIP PLATES/TRIP LEVERS



Blank Trip Plate

| FIG. NO. | PRICE |
|----------|-------|
| 49312 | |



Lever Trip Plate

| FIG. NO. | PRICE |
|----------|-------|
| 15331 | |



Trip Plate Screw (each)

| FIG. NO. | PRICE |
|----------|-------|
| 47209 | |

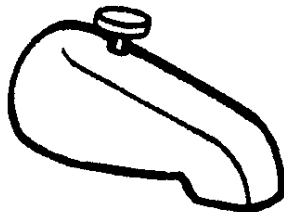

Chrome plated cast brass spout

| FIG. NO. | PRICE |
|----------|-------|
| 61099 | |

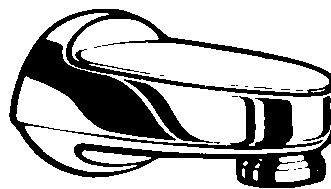

Pull Down Diverter. 1/2" FPT at back

| FIG. NO. | PRICE |
|----------|-------|
| 69250 | |



FIX IT RIGHT THE FIRST TIME!
CALL DUFF FOR ADVICE!
610-275-4453

WATER COOLERS BY HALSEY T TAYLOR AND SUNROC

COMPACT FLOOR COOLER UNITS

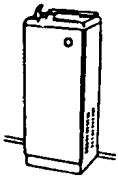

Floor mounted compact units by Halsey Taylor.

| GALLON | SUNROC FIG. NO. | PRICE | HALSEY TAYLOR FIG. NO. | PRICE |
|--------|-----------------|-------|------------------------|-------|
| 2 | N/A | | 50719 | |
| 5 | N/A | | 44870 | |
| 9.6 | N/A | | 77461 | |

COMPACT WALL COOLER UNITS

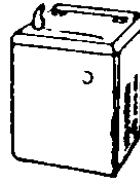

Wall mounted compact units by Sunroc and Halsey Taylor.

| GALLON | SUNROC FIG. NO. | PRICE | HALSEY TAYLOR FIG. NO. | PRICE |
|--------|-----------------|-------|------------------------|-------|
| 4 | 52327 | | 77454 | |

DELUXE FLOOR MODEL COOLERS

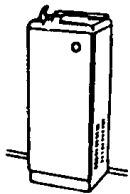

Flush to the wall installation. Stainless steel cabinet available for outdoor use.

| GALLON | SUNROC FIG. NO. | PRICE | HALSEY TAYLOR FIG. NO. | PRICE |
|--------|-----------------|-------|------------------------|-------|
| 4 | 6300 | | 78793 | |
| 8 | 6304 | | 78247 | |
| 14 | 6311 | | 76183 | |
| 20 | 6317 | | 78795 | |

DELUXE HOT AND COLD FLOOR MODEL

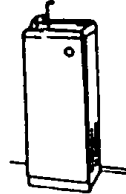

Flush to the wall installation. Fitted with a hot water tank.

| GALLON | SUNROC FIG. NO. | PRICE | HALSEY TAYLOR FIG. NO. | PRICE |
|--------|-----------------|-------|------------------------|-------|
| 8 | 6375 | | | |
| 14 | 6388 | | 78794 | |

FLOOR MODEL DUAL HEIGHT COOLERS

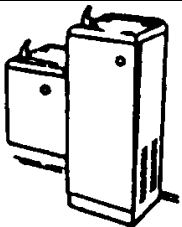

Floor mounted Model. Designed so both adults and children can be served at the same location.

| GALLON | SUNROC FIG. NO. | PRICE | HALSEY TAYLOR FIG. NO. | PRICE |
|--------|-----------------|-------|------------------------|-------|
| 8 | 60600 | | N/A | |

DELUXE WALL MOUNTED COOLER

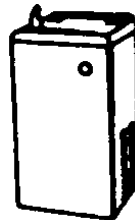

Wall mounted to conceal all electrical connections.

| GALLON | SUNROC FIG. NO. | PRICE | HALSEY TAYLOR FIG. NO. | PRICE |
|--------|-----------------|-------|------------------------|-------|
| 8 | 6324 | | 75082 | |
| 14 | 6331 | | 70198 | |

DELUXE HOT AND COLD WALL MOUNTED COOLER

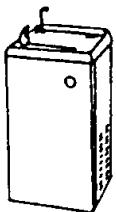

Wall mounted to conceal all electrical connections. Fitted with hot water tank.

| GALLON | SUNROC FIG. NO. | PRICE | HALSEY TAYLOR FIG. NO. | PRICE |
|--------|-----------------|-------|------------------------|-------|
| 8 | 44868 | | N/A | |

WALL MOUNTED DUAL HEIGHT COOLERS

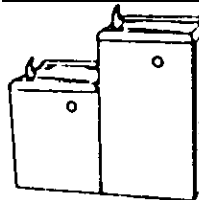

Designed so both adults and children can be served at the same location.

| GALLON | SUNROC FIG. NO. | PRICE | HALSEY TAYLOR FIG. NO. | PRICE |
|--------|-----------------|-------|------------------------|-------|
| 8 | 60680 | | N/A | |

WATER COOLERS BY SUNROC AND HALSEY TAYLOR (CONT'D)

BARRIER-FREE COOLERS

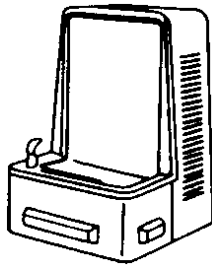

Wall Mounted. Pushdown bars on front and sides may be operated with less than 5 lbs. pressure.

| GALLON | FIG. NO. | PRICE |
|----------|----------|-------|
| Sunroc 8 | 6411 | |
| Halsey 8 | 75371 | |

HANDS FREE OPTION

| | | |
|----------|-------|--|
| Sunroc 8 | 60609 | |
| Halsey 8 | 80078 | |

BARRIER-FREE COOLERS



Wall mounted. Self closing pushdown bars on front and sides require less than 5 lbs. pressure.

| GALLON | FIG. NO. | PRICE |
|----------|----------|-------|
| Sunroc 8 | 47621 | |
| Halsey 8 | 78801 | |

HANDS FREE OPTION

| | | |
|----------|-------|--|
| Sunroc 8 | 60612 | |
| Halsey 8 | 78802 | |

SIMULATED RECESSED COOLERS



High stainless steel backsplash. Projects only 9 1/2" from wall.

| GALLON | FIG. NO. | PRICE |
|----------|----------|-------|
| Sunroc 8 | 44869 | |
| Halsey 8 | 75204 | |

DUAL HEIGHT BARRIER FREE WATER COOLER

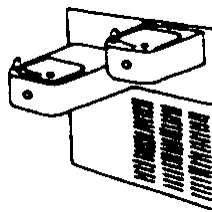

Dual height, dual length. Wall mounted. Seamless curved stainless steel.

| GALLON | FIG. NO. | PRICE |
|----------|----------|-------|
| Sunroc 8 | 60611 | |
| Halsey 8 | 78803 | |

What exactly is the difference between a water cooler and a water fountain?

*A **water cooler** has a refrigeration unit which chills the water. A **water fountain** dispenses water at normal temperature.*

SEMI-RECESSED COOLER

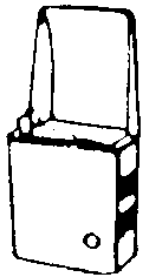

High curved backsplash for plenty of head room. Stainless steel basin.

| GALLON | SUNROC FIG. NO. | PRICE | HALSEY TAYLOR FIG. NO. | PRICE |
|--------|-----------------|-------|------------------------|-------|
| 8 | 6351 | | 70884 | |

BOTTLED WATER COOLERS



Only electrical outlet needed. All stainless steel electrical components. Accepts both 3 and 5 gallon bottles.

| DESCR | SUNROC FIG. NO. | PRICE | HALSEY TAYLOR FIG. NO. | PRICE |
|------------|-----------------|-------|------------------------|-------|
| COLD ONLY | 6293 | | N/A | |
| HOT & COLD | 42927 | | 80077 | |

WATER FOUNTAINS

WALL MOUNTED DRINKING FOUNTAIN

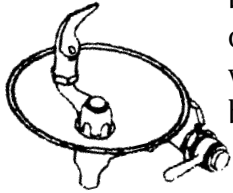

Stainless steel bowl. 3/8" IP connection with wall bracket.

| FIG. NO. | PRICE |
|----------|-------|
| 8578 | |

WALL HUNG DRINKING FOUNTAIN

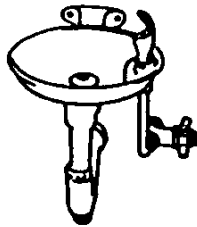

Cast alloy painted bowl. 1/2" IP self closing supply valve. Automatic spray control.

| FIG. NO. | PRICE |
|----------|-------|
| 6284 | |

WALL MOUNTED DRINKING FOUNTAIN



Stainless steel, bronzetone finish.

| FIG. NO. | PRICE |
|----------|-------|
| 60692 | |

VITREOUS CHINA WATER FOUNTAIN

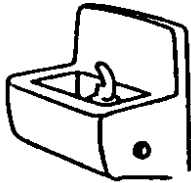

Ideal for school for institution use. Pushbutton operation.

| FIG. NO. | PRICE |
|----------|-------|
| 60682 | |

BARRIER FREE INDOOR/OUTDOOR FOUNTAIN



Stainless steel receptor. Extends 18" from wall.

| FIG. NO. | PRICE |
|----------|-------|
| 60681 | |

BARRIER FREE INDOOR/OUTDOOR FOUNTAIN



Wall mounted stainless steel drinking fountain

| FIG. NO. | PRICE |
|----------|-------|
| 60686 | |

PEDESTAL DRINKING FOUNTAIN



Freeze resistant. Precast, reinforced concrete. Bubbler is protected by an extension of concrete.

| FIG. NO. | PRICE |
|----------|-------|
| 60687 | |

HEAVY DUTY PEDESTAL DRINKING FOUNTAIN

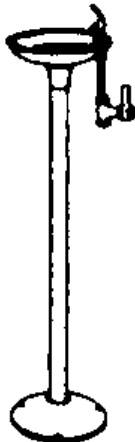

Galvanized pipe, lever handle operation, stainless steel bowl, 1/2" IP supply.

| FIG. NO. | PRICE |
|----------|-------|
| 60691 | |

BARRIER FREE PEDESTAL DRINKING FOUNTAIN

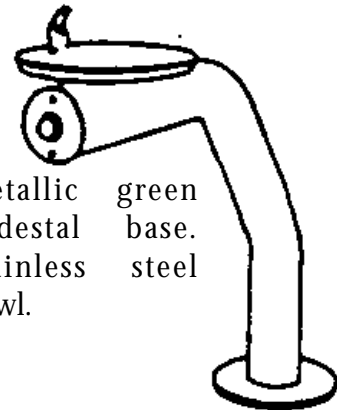

Metallic green pedestal base. Stainless steel bowl.

| FIG. NO. | PRICE |
|----------|-------|
| 60690 | |

DRINKING FAUCETS
AND GLASS FILLERS



Cast brass body drinking faucet - 3/8-18 NPS female. Self close, lever handle with polished chrome finish. Replaceable seat.

| FIG. NO. | PRICE |
|----------|-------|
| 8576 | |



Same as Fig. No. 8576 but back mounted.

| FIG. NO. | PRICE |
|----------|-------|
| 8577 | |

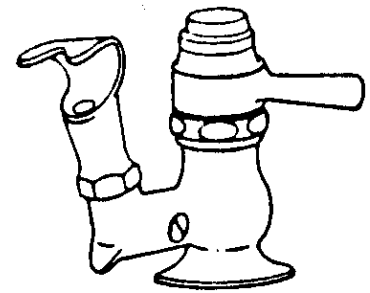

Central Brass cast brass body drinking faucet. Same as Fig No. 8576 but with 1/2-14 NPS male shank.

| FIG. NO. | PRICE |
|----------|-------|
| 18068 | |

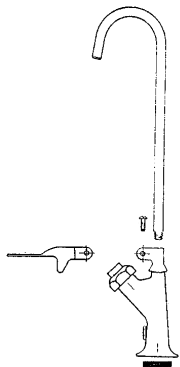

Push down operated glass filler faucet with self closing valve, platform type lever. Bottom of flange to top of gooseneck = 14", Bottom of flange to spout outlet = 11 3/4"

| FIG. NO. | PRICE |
|----------|-------|
| 8566 | |



Push button gravity faucet. Cast brass body, 3/8-18 NPS male shank with polished chrome finish.

| FIG. NO. | PRICE |
|----------|-------|
| 8581 | |

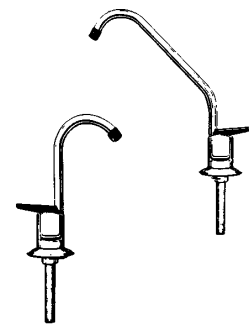

Standard reach faucet - One piece inlet body can be installed through as small as 1/2" hole. Black easy lift handle. Chrome gooseneck.

| FIG. NO. | PRICE |
|----------|-------|
| 23543 | |

Long reach faucet - Same as 23543 but with extra long reach.

| FIG. NO. | PRICE |
|----------|-------|
| 44091 | |

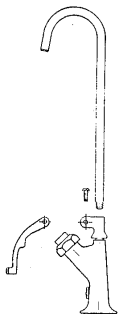

Push back operated glass filler faucet with self closing valve, platform type lever. Bottom of flange to top of gooseneck = 14", Bottom of flange to spout outlet = 11 3/4"

| FIG. NO. | PRICE |
|----------|-------|
| 8567 | |

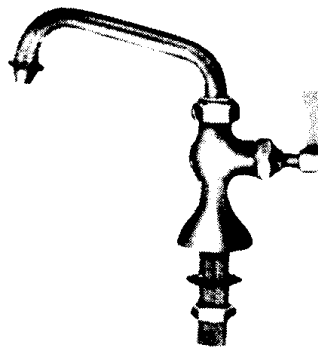

Swivel Spout Steam Table Faucet. Spout swivels 360 Deg and supplies water in any direction. 5" spout. 1/2" NPS Shank. Chrome plated finish.

| FIG. NO. | PRICE |
|----------|-------|
| 60339 | |

WATER COOLER FILTER KIT

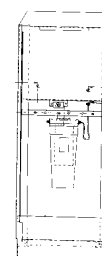

Carbon filter bed, polypropylene post filter. Complete with mounting brackets.

1-5 GPM
7" High Housing

| FIG. NO. | PRICE |
|----------|-------|
| 45164 | |

WATER COOLER PARTS

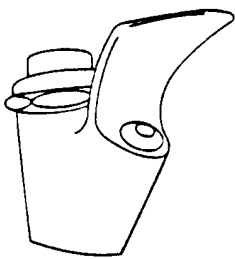

Sunroc 7800 - replacement steady stream bubbler.

| FIG. NO. | PRICE |
|----------|-------|
| 46831 | |



Central Brass Body Bubbler - 3/8 18 NPS female with flange and polished chrome finish.

| FIG. NO. | PRICE |
|----------|-------|
| 8574 | |



Cast brass body bubbler. Same as Fig. No. 8574 but with 1/2 14 NPS male shank.

| FIG. NO. | PRICE |
|----------|-------|
| 25044 | |



Oasis replacement bubbler handle for use on Fig. No. 17548

| FIG. NO. | PRICE |
|----------|-------|
| 47676 | |

HALSEY TAYLOR REGULATORS

NEW STYLE
Ready for immediate shipment!

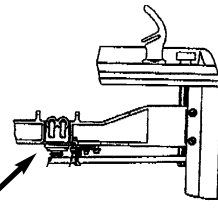

OLD STYLE

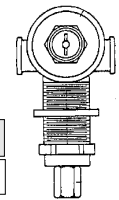

| FIG. NO. | PRICE |
|----------|-------|
| 17547 | |

Bubbler Head



| FIG. NO. | PRICE |
|----------|-------|
| 29221 | |

WITH STREAM CONTROL

| FIG. NO. | PRICE |
|----------|-------|
| 8580 | |

BUBBLER PARTS

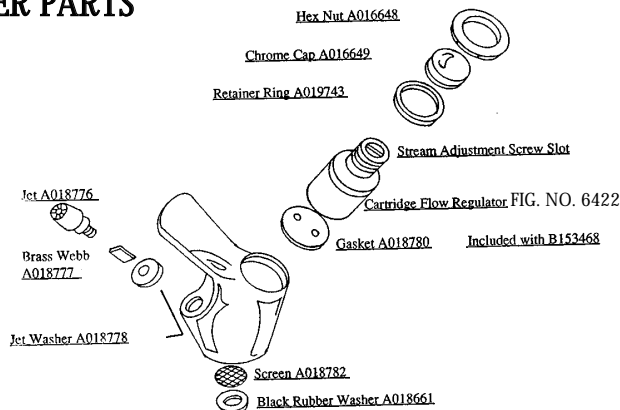

Halsey-Taylor service stop - 3/8" IPS forged brass service stop with screw driver slot

| FIG. NO. | PRICE |
|----------|-------|
| 17546 | |

PARTS FOR HALSEY TAYLOR, EBCO, OASIS, CORDLEY, ELKAY, SUNROC HAWS AND CENTURY ARE READILY AVAILABLE!

SUNROC PUSH BUTTON

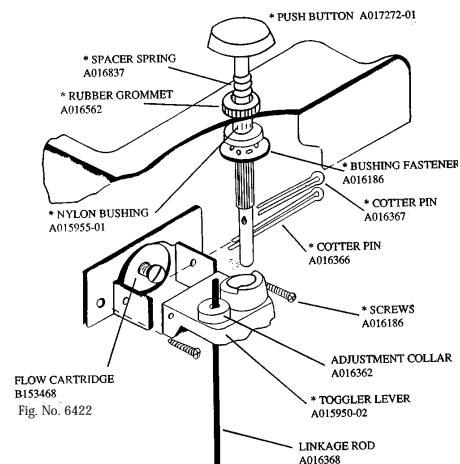

| FIG. NO. | PRICE |
|----------|-------|
| 71448 | |

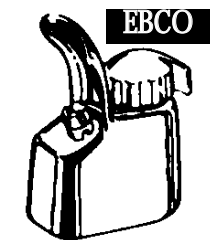

Oasis 1200 - Replacement bubbler. Chrome and plated plastic.

| FIG. NO. | PRICE |
|----------|-------|
| 17548 | |

SUNROC CARTRIDGE

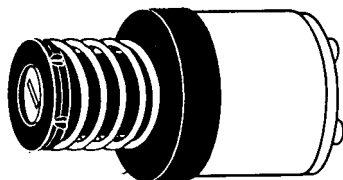

| FIG. NO. | PRICE |
|----------|-------|
| 6422 | |

EMERGENCY EYE WASH & SHOWER

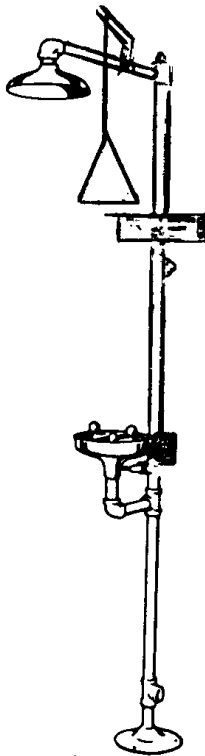

8300 Eyewash and Shower Combination

| FIG. NO. | PRICE |
|----------|-------|
| 31174 | |

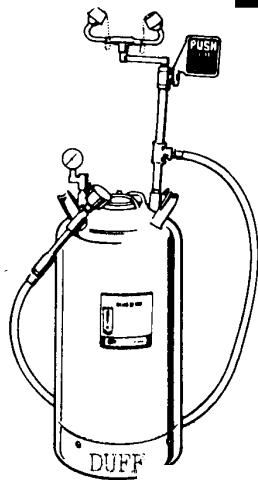

Mobile Tank Eyewash

| FIG. NO. | PRICE |
|----------|-------|
| 87839 | |

For additional information call: 610-275-4453 or Fax: 610-279-6299

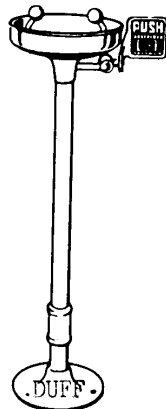

7461 Eyewash Fountain

| FIG. NO. | PRICE |
|----------|-------|
| 31160 | |

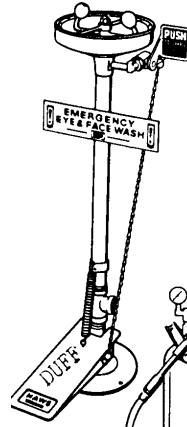

7720 Eyewash Fountain

| FIG. NO. | PRICE |
|----------|-------|
| 31164 | |

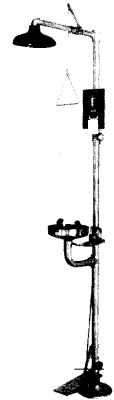

8320 Shower and Eyewash Combination with foot pedal.

| FIG. NO. | PRICE |
|----------|-------|
| 31105 | |

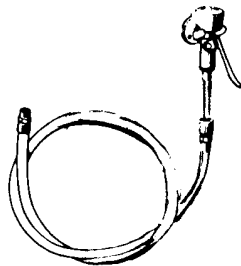

8901B Eye, Face and Body Spray

| FIG. NO. | PRICE |
|----------|-------|
| 31128 | |

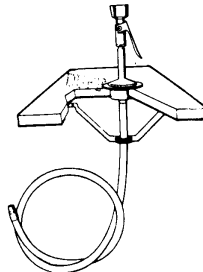

8903 Eye, Face and Body Spray

| FIG. NO. | PRICE |
|----------|-------|
| 31130 | |



8123H Single Handle Drench Shower

| FIG. NO. | PRICE |
|----------|-------|
| 31167 | |

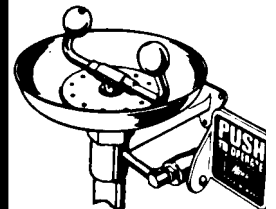

7260B Eyewash Fountain

| FIG. NO. | PRICE |
|----------|-------|
| 31158 | |



5" Apart adjustable Faucet Mount Eyewash

| FIG. NO. | PRICE |
|----------|-------|
| 66355 | |



Faucet Mount Eyewash

| FIG. NO. | PRICE |
|----------|-------|
| 44595 | |

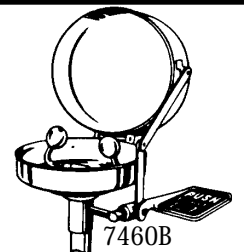

7460B Eyewash Fountain

| FIG. NO. | PRICE |
|----------|-------|
| 31159 | |

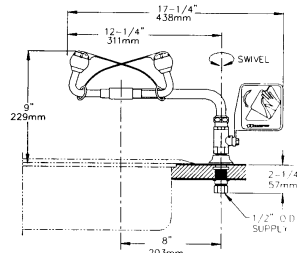

Deck Mounted Eyewash

| FIG. NO. | PRICE |
|----------|-------|
| DG1806 | |



Column shower. Hydrostatically tested to 150 PSI. One set of supply connections required. Preamsembled, complete with drain fitting.

SPECIFICATIONS: Materials - all exposed parts are type 304 stainless steel polished to a #4 finish or polished chrome-plated brass, valve manifold is cast-brass. Drain fitting is cast iron and supply inlets are copper tubing.

CONTACT US FOR HELP WITH YOUR SPECIFIC APPLICATIONS!

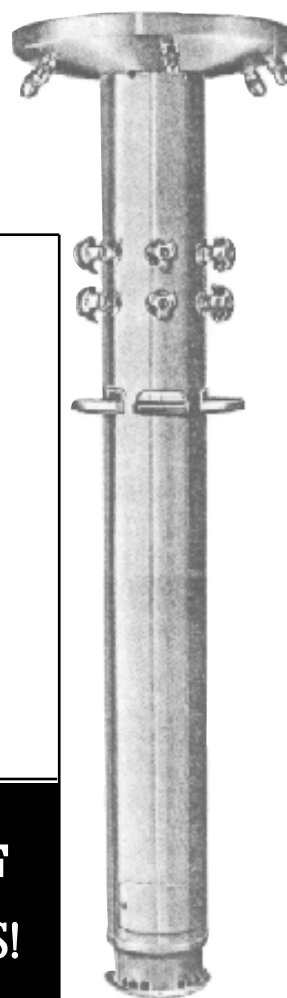

COMBINATION CHECK VALVE

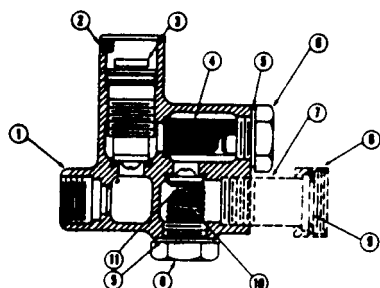

| DESCR | FIG. NO. | PRICE |
|------------------|----------|-------|
| BRASS VALVE ONLY | 67467 | |
| REPAIR KIT | 63703 | |

FOOTVALVE

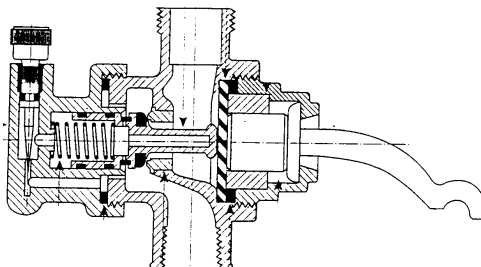

| DESCR | FIG. NO. | PRICE |
|---------------------|----------|-------|
| COMPLETE FOOT VALVE | 38936 | |
| REBUILD KIT | 15126 | |

MANUAL MIXING VALVE

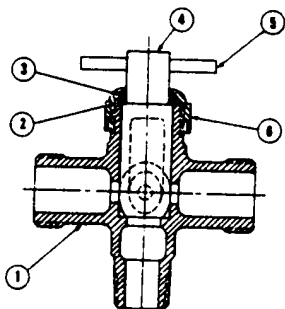

| DESCR | FIG. NO. | PRICE |
|------------------|----------|-------|
| BRASS VALVE ONLY | 67470 | |

OPERATING LEVER

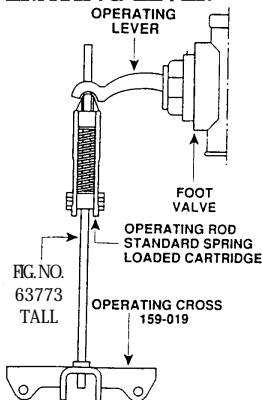

**DUFF
DIFFERS!**

VALVE ASSEMBLIES



VALVE ASSEMBLY NO. S02-018
Furnished from 1949 to 1963.
Only the 125-001L & 160-146 are still available.

ANGLE VOLUME CONTROL VALVE

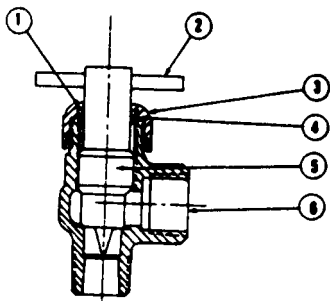

| DESCR | FIG. NO. | PRICE |
|------------------|----------|-------|
| BRASS VALVE ONLY | 67446 | |

BRADTROL CARTRIDGE

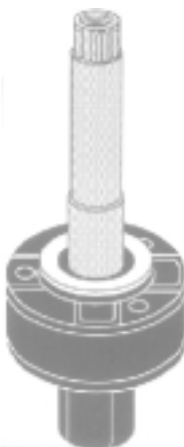

BRADLEY WASH BASINS



CALL FOR SPECS AND PRICES

CHICAGO PARTS AND ACCESSORIES

CHICAGO METERING VALVE

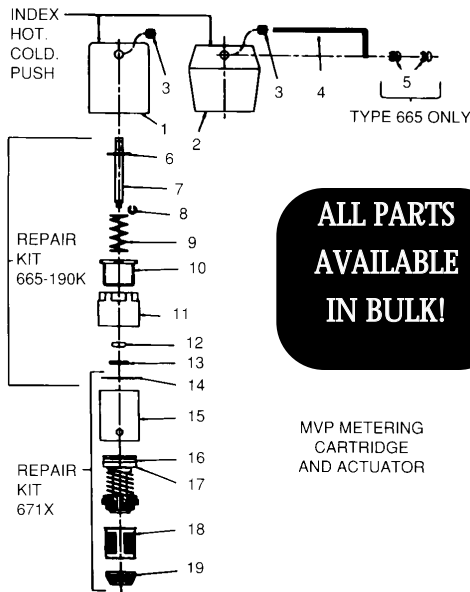

ALL PARTS AVAILABLE IN BULK!

MVP METERING CARTRIDGE AND ACTUATOR

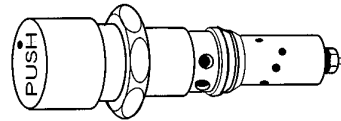

Chicago Slow-Close Lav

| FIG. NO. | PRICE |
|----------|-------|
| 67231 | |

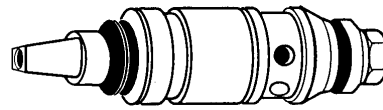

Chicago Stem

| | FIG. NO. | PRICE |
|------|----------|-------|
| HOT | 50777 | |
| COLD | 50776 | |



Lavatory, Kitchen, Tub and shower Repair Kit

| FIG. NO. | PRICE |
|----------|-------|
| 80195 | |

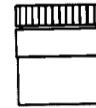

Laminar Flow Aerator to fit Chicago Faucets

| DESCR | FIG. NO. | PRICE |
|--------|----------|-------|
| MALE | 50608 | |
| FEMALE | 80193 | |

CHICAGO BRASS

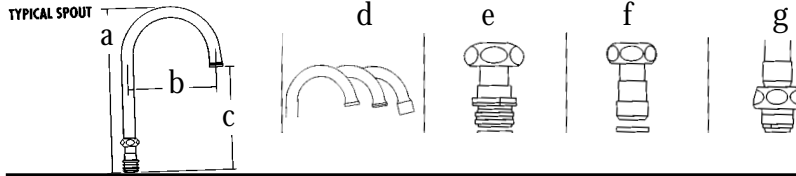

SPEAKMAN ADAPTER AERATOR

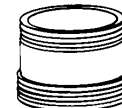

| FIG. NO. | PRICE |
|----------|-------|
| 50609 | |

SPEAKMAN PARTS AND ACCESSORIES

METERING MOUNTINGS

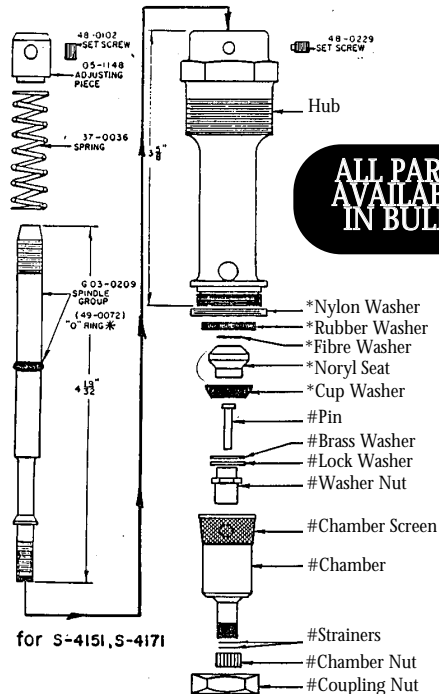

| DESCR | FIG. NO. | PRICE |
|-------------|----------|-------|
| (*) SP-0076 | 64796 | |
| (#) SP-0075 | 64797 | |

SPEAKMAN STEMS & SEATS

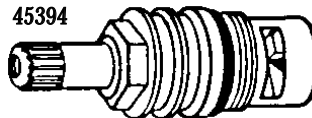

| FIG. NO. | DESCRIPTION | PRICE |
|----------|---|-------|
| 45394 | SPEAKMAN Perfect Stem | |
| 17998 | SPEAKMAN Colortemp cartridge | |
| 15127 | SPEAKMAN piston unit for closets or urinals iwth a 1 1/2" or 1 1/4" spud connection | |
| 21188 | SPEAKMAN seat 7/16 x 27 | |

For additional information call: 610-275-4453 or Fax: 610-279-6299

Please call for current prices.

AMERICAN STANDARD AND KOHLER FAUCET REPAIRS

AMERICAN STANDARD

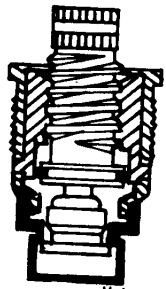

American Standard
Aquaseal stem.

| FIG. NO. | PRICE |
|------------|-------|
| HOT 16910 | |
| COLD 16919 | |

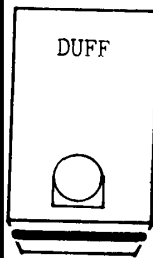

American Standard
Renu Barrel

| FIG. NO. | PRICE |
|------------|-------|
| HOT 16787 | |
| COLD 16792 | |

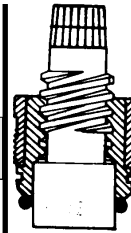

American Standard
Stem Unit

| FIG. NO. | PRICE |
|------------|-------|
| HOT 16875 | |
| COLD 16878 | |

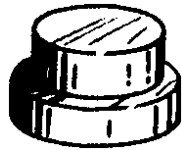

AMERICAN STANDARD
Neoprene washer (top hat washer)

| FIG. NO. | PRICE |
|----------|-------|
| 14778 | |

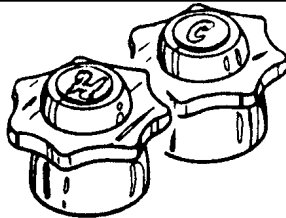

AMERICAN STANDARD

Heritage Lav or Sink Handles.
Chrome plated canopy, includes screws & buttons.

| FIG. NO. | PRICE |
|------------|-------|
| HOT 48084 | |
| COLD 19146 | |

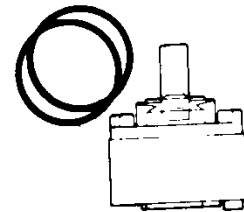

American Standard Aquarian
Cartridge

| FIG. NO. | PRICE |
|----------|-------|
| 15121 | |



AMERICAN STANDARD
Aqua Seal Repair Kit.

| FIG. NO. | PRICE |
|----------|-------|
| 19757 | |

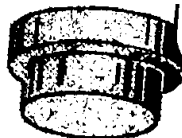

American Standard small
"CADET" Aqua Seal Gasket

| FIG. NO. | PRICE |
|----------|-------|
| 41051 | |

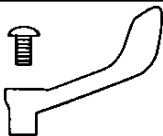

AMERICAN STANDARD
4" WING HANDLES

| FIG. NO. | PRICE |
|------------|-------|
| COLD 50775 | |
| HOT 50774 | |



American Standard Aqua Seal Seat.

| FIG. NO. | PRICE |
|----------|-------|
| 41051 | |

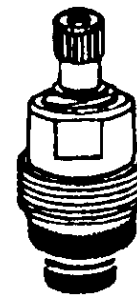

American Standard
Cadet Stem.

| FIG. NO. | PRICE |
|------------|-------|
| HOT 48895 | |
| COLD 48896 | |

KOHLER

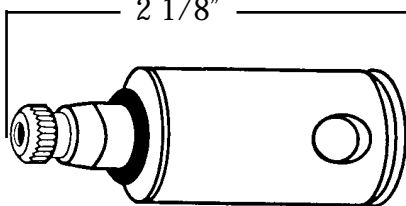

VALVET
Kohler Stem Unit

| FIG. NO. | PRICE |
|------------|-------|
| HOT 17218 | |
| COLD 17219 | |

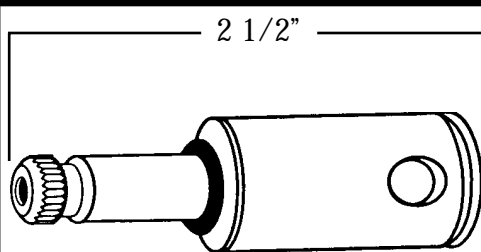

VALVET
Kohler Stem Unit

| FIG. NO. | PRICE |
|------------|-------|
| HOT 17216 | |
| COLD 17217 | |

WATERSAVER

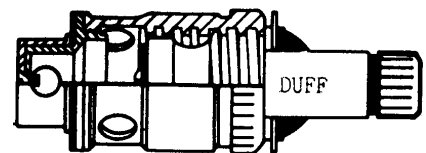

Watersaver Stem

| FIG. NO. | PRICE |
|------------|-------|
| HOT 40840 | |
| COLD 40839 | |

STERLING PARTS

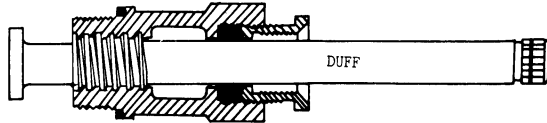

STERLING SHOWER STEM UNIT

| FIG. NO. | PRICE |
|----------|-------|
| 10356 | |

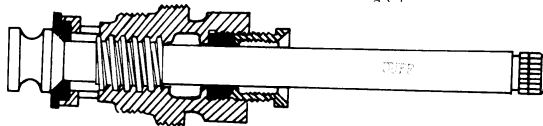

STERLING DIVERTER STEM

| FIG. NO. | PRICE |
|----------|-------|
| 10359 | |

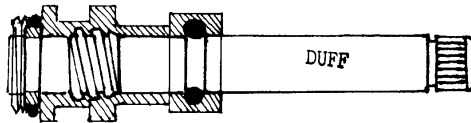

STERLING BATH STEM

| FIG. NO. | PRICE |
|----------|-------|
| 49343 | |

STERLING HANDLES

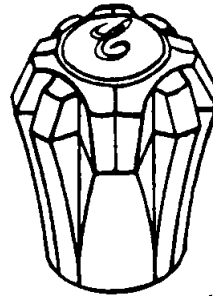

Sterling Faucet Handle
Includes screw and Index button.

| | FIG. NO. | PRICE |
|------|----------|-------|
| COLD | 10390 | |
| HOT | 10391 | |

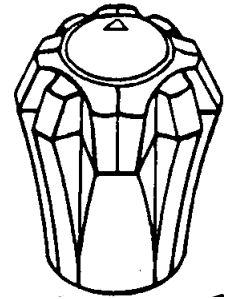

Sterling Diverter Handle
Includes handle screw

| FIG. NO. | PRICE |
|----------|-------|
| 10388 | |

STERLING LAV HANDLE

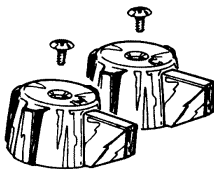

STERLING LAV HANDLES
Chrome plated canopy lever. Screws Included.

| | FIG. NO. | PRICE |
|------|----------|-------|
| HOT | 10383 | |
| COLD | 10385 | |

STERLING BATH HANDLE

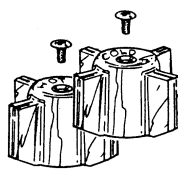

STERLING BATH HANDLES
Chrome plated canopy cross. Screws Included.

| | FIG. NO. | PRICE |
|------|----------|-------|
| HOT | 10394 | |
| COLD | 10395 | |

STERLING TUB DIVERTER HANDLE

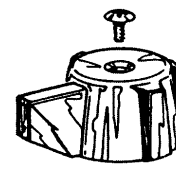

STERLING TUB DIVERTER HANDLES
Chrome plated canopy lever. Screw Included.

| | FIG. NO. | PRICE |
|--|----------|-------|
| | 10379 | |



| FIG. NO. | PRICE |
|----------|-------|
| 10376 | |

ORDER NOW!

Order Now!

610-275-4453

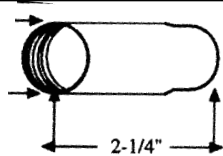

Sterling Sleeve

| FIG. NO. | PRICE |
|----------|-------|
| 0364 | |

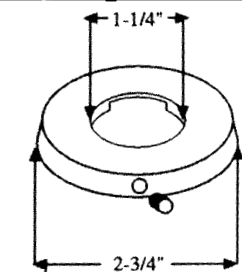

Sterling flat escutcheon.

| FIG. NO. | PRICE |
|----------|-------|
| 50377 | |

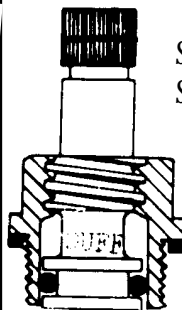

Sterlin Lav Stem

| FIG. NO. | PRICE |
|----------|-------|
| 10425 | |

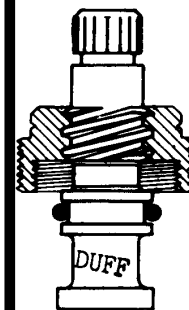

Sterling Laundry Stem

| FIG. NO. | PRICE |
|----------|-------|
| 10419 | |



Sterling Bath & Shower Valve Washer

| FIG. NO. | PRICE |
|----------|-------|
| 10435 | |

REPLACEMENT STEMS AND HANDLES

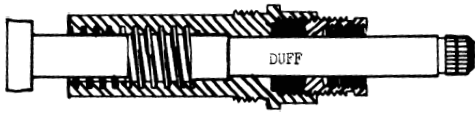

Gerber Shower Valve Stem Unit

| FIG. NO. | PRICE |
|----------|-------|
| 17201 | |

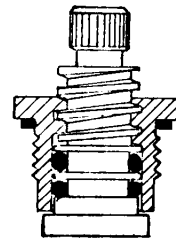

Gerber Lav and Kitchen Stem Unit

| FIG. NO. | PRICE |
|------------|-------|
| HOT 17192 | |
| COLD 17193 | |

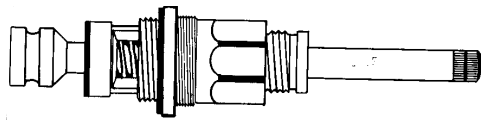

Gerber Diverter Stem

| FIG. NO. | PRICE |
|----------|-------|
| 17199 | |

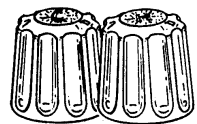

Gerber Bath Handles

| FIG. NO. | PRICE |
|----------|-------|
| 41547 | |

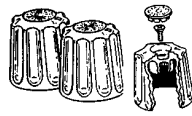

Gerber Deep-Broach Tub Handles

| FIG. NO. | PRICE |
|----------|-------|
| 50551 | |



Gerber Lav or Sink Handles

| FIG. NO. | PRICE |
|----------|-------|
| 41549 | |



Gerber Index Buttons

| FIG. NO. | PRICE |
|----------------|-------|
| HOT 48492 | |
| COLD 48493 | |
| DIVERTER 48494 | |

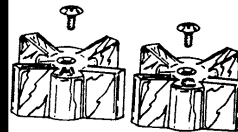

Gerber Old-Style Tub Cross-Handles

| FIG. NO. | PRICE |
|----------|-------|
| 41548 | |

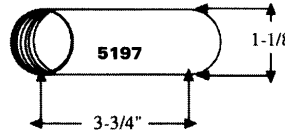

Gerber escutcheon tube.

| FIG. NO. | PRICE |
|----------|-------|
| 48533 | |

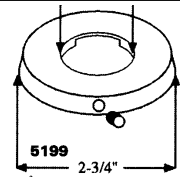

Gerber escutcheon

| FIG. NO. | PRICE |
|----------|-------|
| 45374 | |

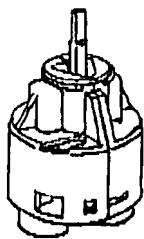

Elkay Cartridge. Drip free, washerless.

| FIG. NO. | PRICE |
|----------|-------|
| 51771 | |

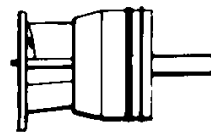

Elkay Permacore. Single lever sink faucet.

| FIG. NO. | PRICE |
|----------|-------|
| 15114 | |

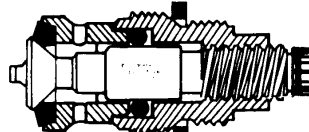

Crane Stem

| FIG. NO. | PRICE |
|------------|-------|
| HOT 17049 | |
| COLD 17053 | |

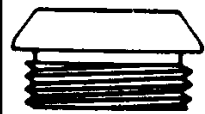

Gerber seat

| FIG. NO. | PRICE |
|----------|-------|
| 19756 | |

ANTI-SCALD DEVICES PROTECTION AT THE FAUCET PROTECT CHILDREN AND SENIORS!

PP1996 Anti Scald Aerator 55/64" I.D. Thread

PP1997 Anti Scald Aerator 15/16" O.D. Thread

PP1994 Anti Scald Shower Arm Insert

PP1995 Anti Scald Bath Tub Spout
MAX TEMP 120°F

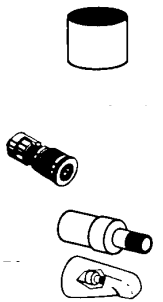

Universal Rundle Interchangeable Stems

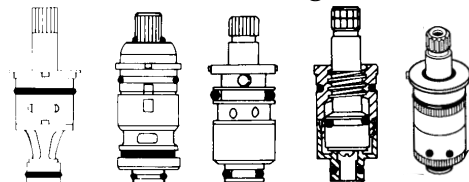

All Inter-changeable

| FIG. NO. | PRICE |
|------------|-------|
| HOT 17449 | |
| COLD 17450 | |

HANDLES

GRIPITTE LUCITE HANDLES



Plastic fit-all lav handles (pair)

| FIG. NO. | PRICE |
|----------|-------|
| 48855 | |



Plastic fit-all bath handles (pair)

| FIG. NO. | PRICE |
|----------|-------|
| 47938 | |



Plastic fit-all diverter handle.

| FIG. NO. | PRICE |
|----------|-------|
| 47939 | |

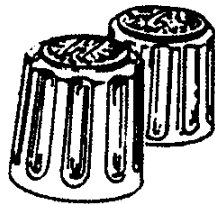

Plastic fit-all tub handle (pair)

| FIG. NO. | PRICE |
|----------|-------|
| 58605 | |

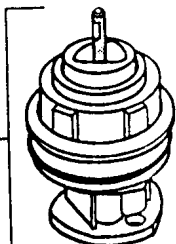

Valley single lever cartridge assembly

| FIG. NO. | PRICE |
|----------|-------|
| 39087 | |

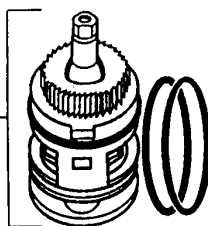

Valley faucet cartridge assembly

| FIG. NO. | PRICE |
|----------|-------|
| 49314 | |

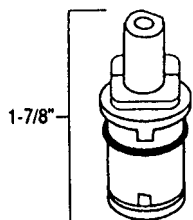

Valley washerless control mechanism

| FIG. NO. | PRICE |
|----------|-------|
| 7996 | |

NOT SURE WHICH IS FOR YOU? ASK ONE OF THE EXPERTS AT DUFF! 610-275-4453

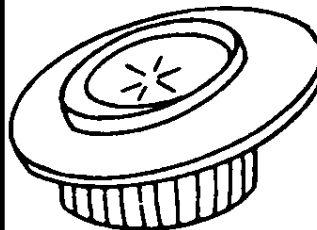

VALLEY acrylic handle

| FIG. NO. | PRICE |
|----------|-------|
| 7966 | |



Valley single lever faucet repair kit. Contains 1 control plate O-ring, 3 spout O-rings, 2 seats, 2 springs, 2 spring inserts, 2 inlet seals, 1 wrench and lubricant.

| FIG. NO. | PRICE |
|----------|-------|
| 7766 | |

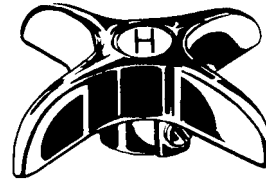

Pair - Griptite cross handle - chrome plated.

| FIG. NO. | PRICE |
|----------|-------|
| 15065 | |

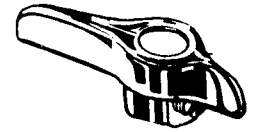

Pair - Griptite lever handle - chrome plated.

| FIG. NO. | PRICE |
|----------|-------|
| 15062 | |

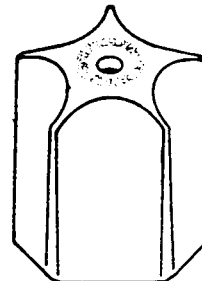

Griptite five point handle chrome plated (each)

| FIG. NO. | PRICE |
|----------|-------|
| 58602 | |

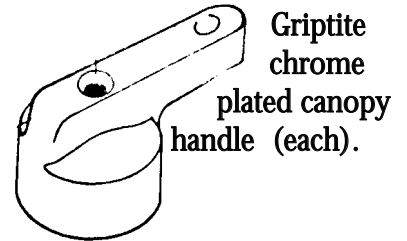

Griptite chrome plated canopy handle (each).

Lav base = 1 7/16"
Tub base - 1 5/8"

| | FIG. NO. | PRICE |
|-----|----------|-------|
| LAV | 58603 | |
| TUB | 58604 | |

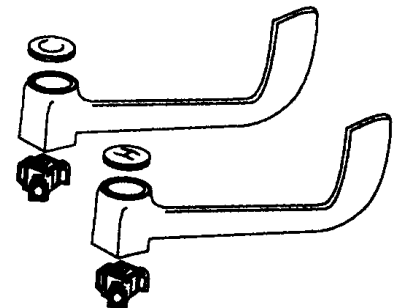

Griptite elbow handles (pair)

| FIG. NO. | PRICE |
|----------|-------|
| 58601 | |

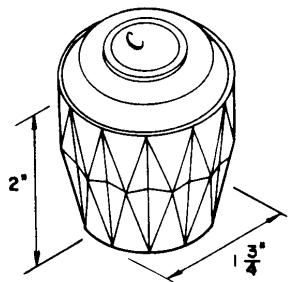

Valley acrylic handle. Pair.

| FIG. NO. | PRICE |
|----------|-------|
| 8093 | |

AERATORS

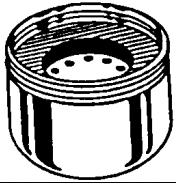

| | |
|---------------------|--------------|
| DUAL AERATOR | |
| FIG. NO. | PRICE |
| 15145 | |

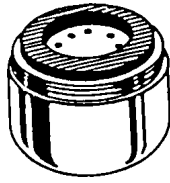

| | |
|---------------------------|--------------|
| 15/16 MALE AERATOR | |
| FIG. NO. | PRICE |
| 43461 | |

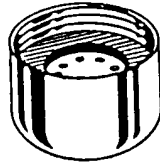

| | |
|-----------------------------|--------------|
| 15/16 FEMALE AERATOR | |
| FIG. NO. | PRICE |
| 43462 | |

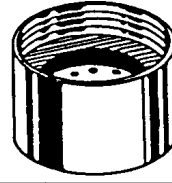

| | |
|-----------------------------|--------------|
| 13/16 FEMALE AERATOR | |
| FIG. NO. | PRICE |
| 15147 | |



| | |
|---------------------------|--------------|
| 13/16 MALE AERATOR | |
| FIG. NO. | PRICE |
| 15146 | |

LOW FLOW

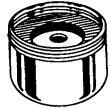

| | |
|---------------------------------|--------------|
| 1.5 LOW FLOW DUAL THREAD | |
| FIG. NO. | PRICE |
| 48651 | |

AERATOR

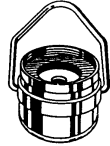

| | |
|-----------------------------------|--------------|
| 15/16 VANDAL PROOF AERATOR | |
| FIG. NO. | PRICE |
| 40816 | |

AERATOR BUSHING



| | |
|------------------------------|--------------|
| 15/16 X 13/16 BUSHING | |
| FIG. NO. | PRICE |
| 65514 | |

MALE AERATOR ADAPTER

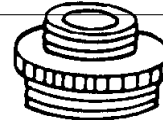

| | | |
|------------------------------|-----------------|--------------|
| STANDARD MALE AERATOR | | |
| SIZE | FIG. NO. | PRICE |
| 1/4 | 65518 | |
| 3/8 | 50610 | |
| 13/16 | 50601 | |

SNAP AERATORS



| | |
|---------------------------|--------------|
| LARGE SNAP AERATOR | |
| FIG. NO. | PRICE |
| 47228 | |

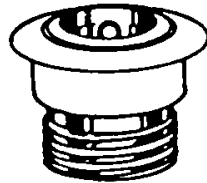

| | |
|--------------------------------|--------------|
| HOSE SNAP COUPLER LARGE | |
| FIG. NO. | PRICE |
| 15150 | |



| | |
|---------------------------|--------------|
| SMALL SNAP AERATOR | |
| FIG. NO. | PRICE |
| 15144 | |

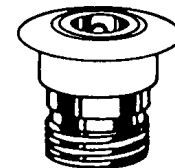

| | |
|--------------------------------|--------------|
| HOSE SNAP COUPLER SMALL | |
| FIG. NO. | PRICE |
| 15151 | |

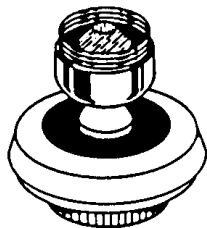

| | |
|---------------------------|--------------|
| SWIVEL MXF AERATOR | |
| FIG. NO. | PRICE |
| 15148 | |

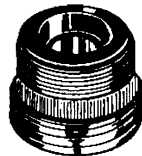

| | |
|-------------------------------------|--------------|
| DUAL AERATOR TO HOSE ADAPTER | |
| FIG. NO. | PRICE |
| 15152 | |

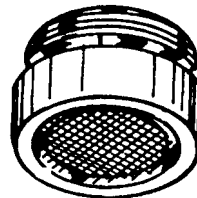

| | |
|----------------------------------|--------------|
| LAMINAR FLOW DUAL AERATOR | |
| FIG. NO. | PRICE |
| 50547 | |

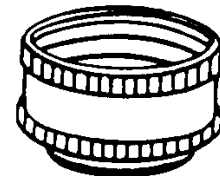

| | |
|--------------------------------|--------------|
| HOSE TO AERATOR ADAPTER | |
| FIG. NO. | PRICE |
| 52234 | |

ASSORTED NEOPRENE WASHERS

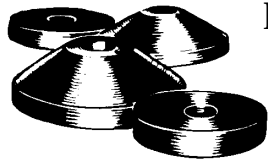

Packed 100 to a Plastic Container.

| FLAT | | |
|------|----------|-------|
| SIZE | FIG. NO. | PRICE |
| #0 | 24683 | |
| #00 | 14941 | |
| 1/4S | 14943 | |
| 1/4 | 14945 | |
| 1/4L | 14951 | |
| 3/8 | 14953 | |
| 3/8M | 14954 | |
| 3/8L | 14955 | |
| 1/2 | 14956 | |
| 1/2L | 14957 | |
| 5/8 | 14958 | |

| BEVELED | | |
|---------|----------|-------|
| SIZE | FIG. NO. | PRICE |
| #0 | 24686 | |
| #00 | 14918 | |
| 1/4 | 14922 | |
| 1/4L | 14924 | |
| 3/8 | 14927 | |
| 3/8M | 14928 | |
| 3/8L | 14930 | |
| 1/2 | 14931 | |
| 1/2L | 14935 | |
| 5/8 | 14938 | |

BRASS BOXED BIBB SCREWS (100 PER PACK)

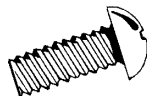

| SIZE | FIG. NO. | PRICE |
|-----------|----------|-------|
| ASSORTED | 14909 | |
| 1/2X10-24 | 14908 | |
| 1/2X8-32 | 14906 | |
| 3/8X10-24 | 14907 | |
| 3/8X8-32 | 66823 | |

WASHERS

JUNIOR NEOPRENE WASHER KIT



Includes 100 washers and 18 Brass Screws.

| FLAT | | BEVELED | |
|----------|-------|----------|-------|
| FIG. NO. | PRICE | FIG. NO. | PRICE |
| 14962 | | 14916 | |

TAPERED NYLON SLIP JOINT WASHER

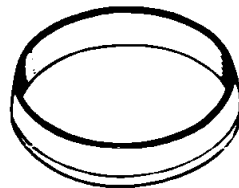

| SIZE | FIG. NO. | PRICE |
|-----------|----------|-------|
| 1 1/4 | 1/4 | 14736 |
| 1 1/2 | | 14738 |
| 1 1/2 X 1 | | 14742 |

AMERICAN STANDARD GRAPHITE URINAL GASKET



| FIG. NO. | PRICE |
|----------|-------|
| 14654 | |

SINK CONNECTION WASHER



| FIG. NO. | PRICE |
|----------|-------|
| 14687 | |

TUB OVERFLOW WASHERS



| FIG. NO. | PRICE |
|----------|-------|
| 19000 | |

SENIOR NEOPRENE WASHER KIT



Includes 200 washers and 50 Brass Screws.

| FLAT | | BEVELED | |
|----------|-------|----------|-------|
| FIG. NO. | PRICE | FIG. NO. | PRICE |
| 38923 | | 38922 | |

NYLON TAILPIECE WASHER

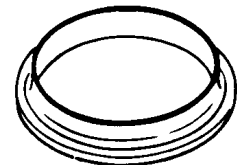

| SIZE | FIG. NO. | PRICE |
|-------|----------|-------|
| 1 1/2 | 14685 | |

KOHLER URINAL GASKET



| FIG. NO. | PRICE |
|----------|-------|
| 4938 | |

RUBBER SLIP JOINT WASHERS



| SIZE | FIG. NO. | PRICE |
|---------------|----------|-------|
| 1 1/4" | 14723 | |
| 1 1/2" | 14726 | |
| 2" | 14729 | |
| 1 1/2 X 1 1/4 | 14731 | |

BIBB SCREW TAP 10-24

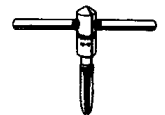

| FIG. NO. | PRICE |
|----------|-------|
| 43273 | |

"O" RINGS FULL SCALE DRAWINGS

American Standard

Ballcock

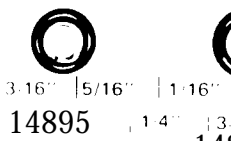

Acme Brass



Eljer Lusterline



Central Brass

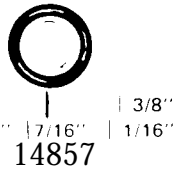

Universal-Rundle



14863
Sterling, Repcal
Price-Pfister



14876
American Standard
Aqua Seal

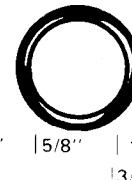

14886
Streamway



Central, Indiana

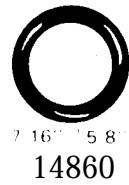

Delta

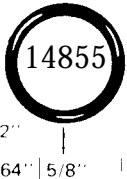

"Crane" R stems



Moen, Eljer, Sayco



Price-Pfister, Schaible,



Price-Pfister,
Arrowhead Brass,
American-Standard



Eljer "Crane" R
American-Standard



Kohler



Mullins, Briggs or Republic
Schaible, Dishmaster, Central



Union Brass



Gerber, Harcraft, Kohler

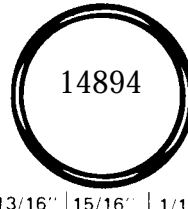

"Crane" R Milwaukee

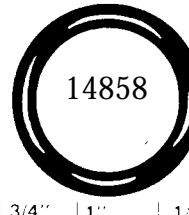

Moen, Eljer

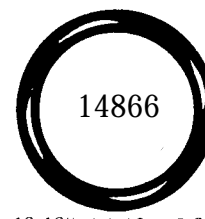

Kohler

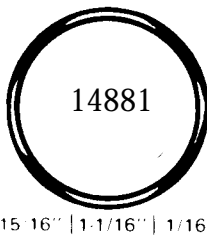

Harcraft, Delta, Repcal, "Crane" R

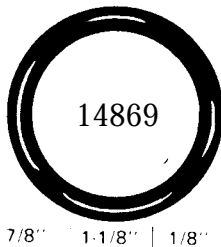

Schaible, American-Standard

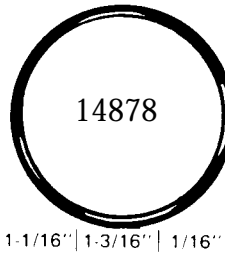

Atamark

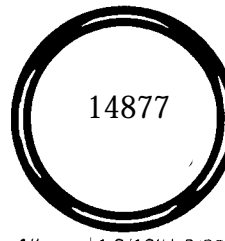

Moen

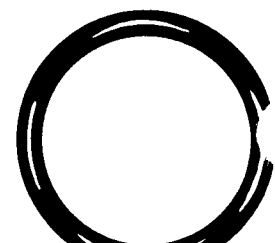

Moen, Delta

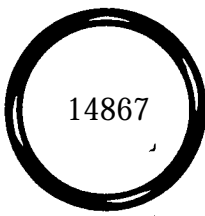

Delta, Eljer, Speakman



Sears, Wolverine, Speakman

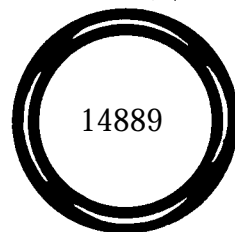

Delta, American-Standard

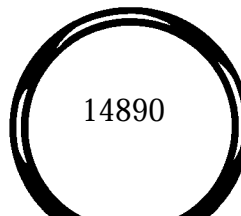

Mullins Sterling

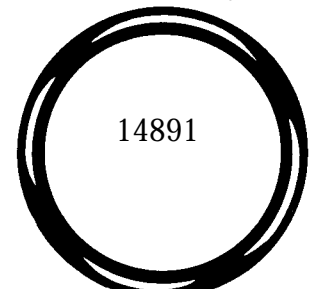

American-Standard

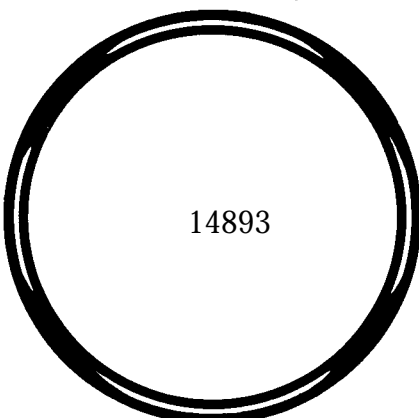

Speakman

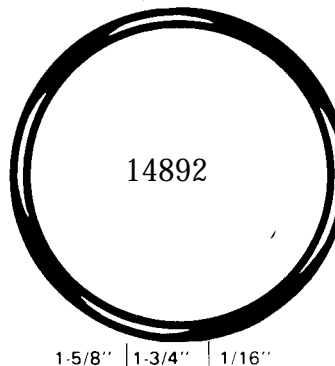

Moen No. 722-9A

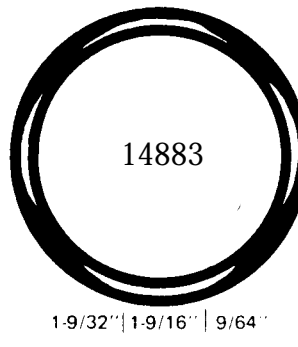

Delta

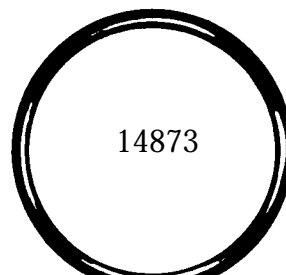

FAUCET REPAIR KITS

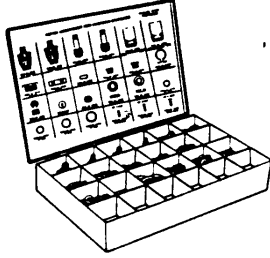

American Standard

| FIG. NO. | PRICE |
|----------|-------|
| 15080 | |

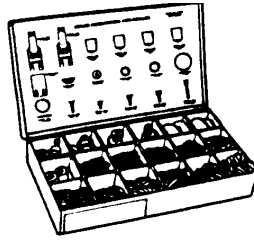

Kohler

| FIG. NO. | PRICE |
|----------|-------|
| 15086 | |

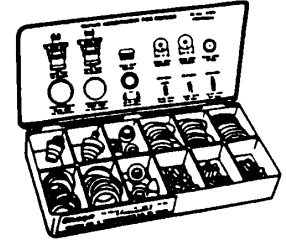

Gerber

| FIG. NO. | PRICE |
|----------|-------|
| 15088 | |



Central Brass

| FIG. NO. | PRICE |
|----------|-------|
| 15093 | |

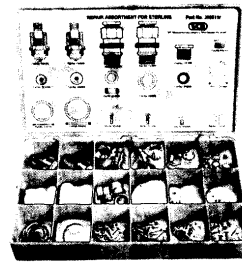

Sterling

| FIG. NO. | PRICE |
|----------|-------|
| 15095 | |

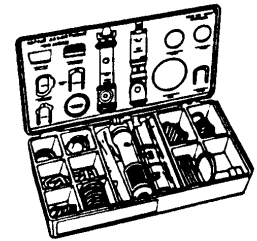

Moen

| FIG. NO. | PRICE |
|----------|-------|
| 15096 | |

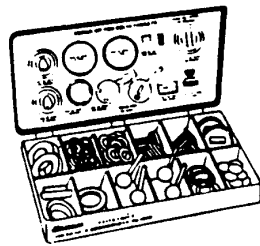

Delta

| FIG. NO. | PRICE |
|----------|-------|
| 19905 | |

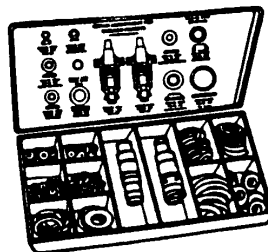

Chicago

| FIG. NO. | PRICE |
|----------|-------|
| 45361 | |

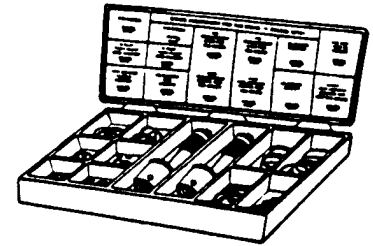

T & S

| FIG. NO. | PRICE |
|----------|-------|
| 62339 | |

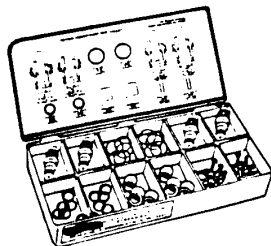

Valley

| FIG. NO. | PRICE |
|----------|-------|
| 54282 | |

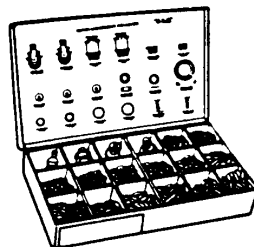

Sayco

| FIG. NO. | PRICE |
|----------|-------|
| 15089 | |

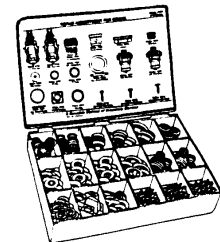

Crane

| FIG. NO. | PRICE |
|----------|-------|
| 15094 | |

KITS AND ASSORTMENTS

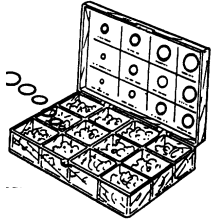

Plumbers "O" Ring Kit. 200 assorted rings, 12 of the most popular sizes.

| FIG. NO. | PRICE |
|----------|-------|
| 14899 | |

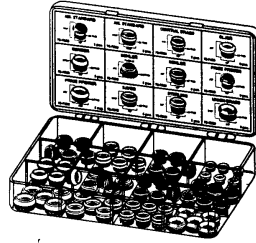

Faucet Seat Kit. 64 of the 12 most popular seat sizes!

| FIG. NO. | PRICE |
|----------|-------|
| 15097 | |

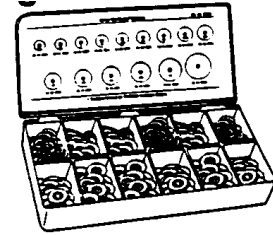

Replacement Kit of faucet washers. 100 washers with 18 brass screws.

| DESCR | FIG. NO. | PRICE |
|-------|----------|-------|
| FLAT | 14962 | |
| BEV | 14916 | |

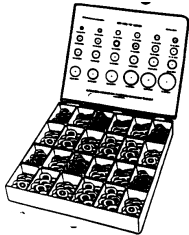

Industrial "O" Ring kit. The most complete assortment available. 420 pieces of 24 different sizes.

| FIG. NO. | PRICE |
|----------|-------|
| 65084 | |

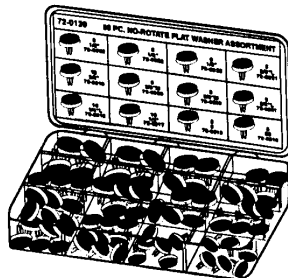

80 piece assortment "No Rotate" washers.

| FIG. NO. | PRICE |
|----------|-------|
| 65081 | |

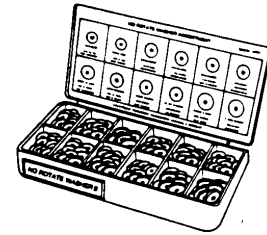

Replacement kits for faucet washers. 200 washers with 50 brass screws.

| DESCR | FIG. NO. | PRICE |
|-------|----------|-------|
| FLAT | 38923 | |
| BEV | 38922 | |

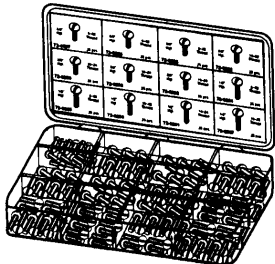

Kit for brass faucet screws. 300 pieces of 12 different sizes.

| FIG. NO. | PRICE |
|----------|-------|
| 65085 | |

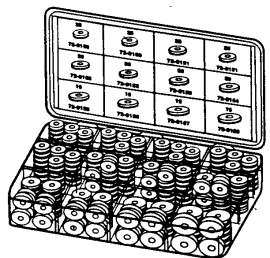

Washer Retainer Kit. 300 pieces of sizes 00-5/8L.

| FIG. NO. | PRICE |
|----------|-------|
| 65086 | |

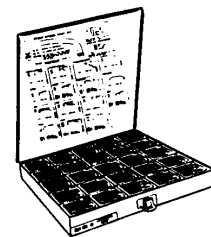

Replacement kit for kitchen spout repairs.

| FIG. NO. | PRICE |
|----------|-------|
| 65080 | |

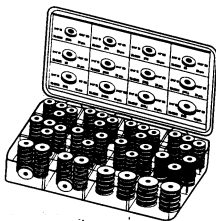

Replacement kits for fibre faucet washers. 240 pieces of 10 different sizes.

| FIG. NO. | PRICE |
|----------|-------|
| 65087 | |

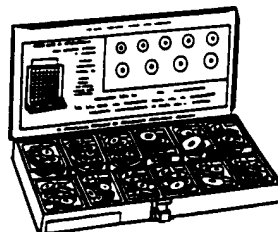

Replacement kits for teflon faucet washers. 96 pieces of sizes 000 to 1/2"

| FIG. NO. | PRICE |
|----------|-------|
| 65088 | |

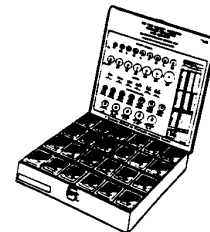

Replacement kit for faucet washers, washer retainers & screws. Contains 316 pieces of 48 different types!

| FIG. NO. | PRICE |
|----------|-------|
| 65097 | |

KITS (CONT'D)

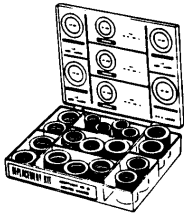

Replacement kit for aerator washers. 150 pieces of 7 different sizes.

| FIG. NO. | PRICE |
|----------|-------|
| 65101 | |

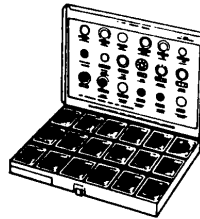

Replacement kit for aerator repairs. 105 pieces of 18 different styles.

| FIG. NO. | PRICE |
|----------|-------|
| 65102 | |

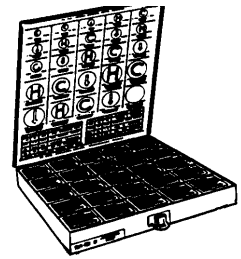

Replacement kits for index buttons. 100 pieces of 25 different types.

| FIG. NO. | PRICE |
|----------|-------|
| 65103 | |

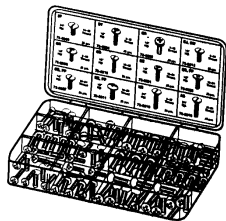

Replacement kits for chrome faucet handle screws. Contains 300 pieces of 12 different sizes.

| FIG. NO. | PRICE |
|----------|-------|
| 65104 | |



Replacement kit for lavatory pop-up repairs. 40 pieces.

| FIG. NO. | PRICE |
|----------|-------|
| 65100 | |



Replacement kit for automatic spray diverters. 18 different types.

| FIG. NO. | PRICE |
|----------|-------|
| 65099 | |

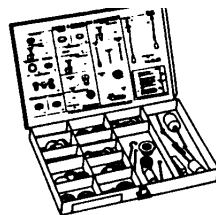

Replacement kit for waste & overflow. 47 pieces of 24 different types.

| FIG. NO. | PRICE |
|----------|-------|
| 65098 | |

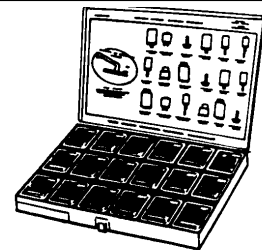

Ballcock repair kit. 180 pieces of 18 different types.

| FIG. NO. | PRICE |
|----------|-------|
| 65093 | |

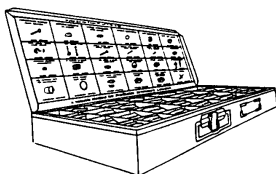

Replacement kit for frostproof sillcocks. 99 pieces of 24 different types.

| FIG. NO. | PRICE |
|----------|-------|
| 65096 | |

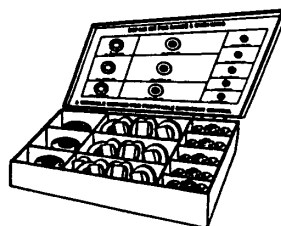

Replacement kit for electric and gas range oven knobs. Electric has 86 pieces of 11 different types. Gas contains 74 pieces of 8 different types.

| DESCR | FIG. NO. | PRICE |
|----------|----------|-------|
| Electric | 65095 | |
| Gas | 65132 | |

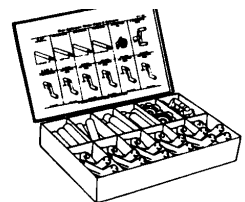

Replacement kit for window cranks & extensions. 50 pieces of 13 different styles.

| FIG. NO. | PRICE |
|----------|-------|
| 65094 | |

KITS (CONT'D)

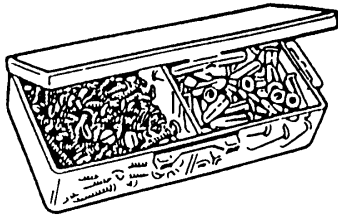

Screw anchor kit, 100 plastic anchors, 100 combination 10x1 metal screws, 1/4" masonry drill bit.

| FIG. NO. | PRICE |
|----------|-------|
| 37665 | |

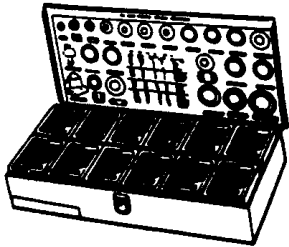

Bath diverter kit, 130 pieces, 22 different sizes.

| FIG. NO. | PRICE |
|----------|-------|
| 73453 | |

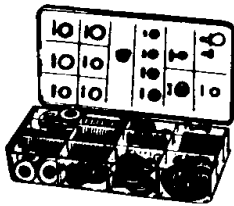

Faucet Stem Nut Fibre Washers. 200 in Kit.

| FIG. NO. | PRICE |
|----------|-------|
| 56832 | |

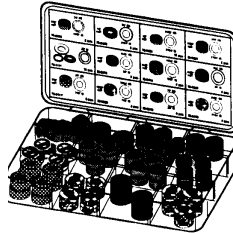

Bonnet packing kit. 98 piece assorted faucet stem bonnet packings.

| FIG. NO. | PRICE |
|----------|-------|
| 73451 | |

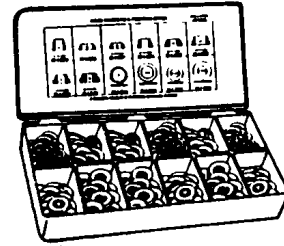

Replacement kit for cone washers. 78 total pieces of 11 different sizes.

| FIG. NO. | PRICE |
|----------|-------|
| 73452 | |

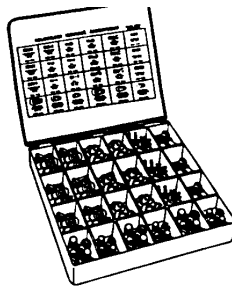

Replacement kit for solderless terminals. Contains 223 total pieces.

| FIG. NO. | PRICE |
|----------|-------|
| 73454 | |



Commercial O-ring Kit

| FIG. NO. | PRICE |
|----------|-------|
| 66799 | |

WE'RE FLEXIBLE!

CUSTOM KITS ARE OUR SPECIALTY!

CALL OR SEE YOUR DUFF SALESPERSON TODAY!



For additional information call: 610-275-4453 or Fax: 610-279-6299.
Please call for current prices.

INSINKERATOR

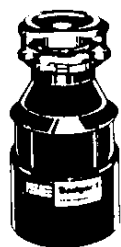

ISE BADGER 1 - Continuous feed, 1/3 HP motor, Stainless Steel sink flange. Galvanized steel shredder ring. 1 year parts and in home service warranty.

| FIG. NO. | PRICE |
|----------|-------|
| 7876 | |

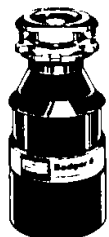

ISE BADGER V - Continuous feed, 1/2 HP motor, Galvanized steel shredder with 2 Stainless Steel impellers. 1 year parts and in one service warranty.

| FIG. NO. | PRICE |
|----------|-------|
| 7874 | |



ISE 333 - Continuous feed, 1/2 HP motor, Corrosion resistant Stainless Steel rotating shredders and shredder ring. 3 year parts and in home service warranty.

| FIG. NO. | PRICE |
|----------|-------|
| 7871 | |



ISE 333SS - Continuous feed, 3/4 HP motor, Stainless Steel rotating shredder ring and grind chamber. 4 year parts and in home service warranty.

| FIG. NO. | PRICE |
|----------|-------|
| 7867 | |



ISE 77 - Continuous feed, 3/4 HP motor, wear resistant nickel chrome shredder ring. stainless steel rotating shredder and grinding elements. 5 year parts and in home service warranty.

| FIG. NO. | PRICE |
|----------|-------|
| 7855 | |



ISE 17 - Batch feed, 3/4 HP motor. Stainless Steel grind chamber resists corrosion. Large cast nickel chrome shredder ring. Corrosion shield protects motor. 5 year parts and in home service warranty.

| FIG. NO. | PRICE |
|----------|-------|
| 7863 | |

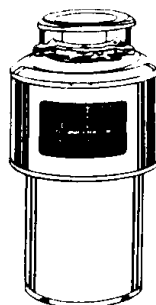

ISE LC-50 Continuous duty commercial motor. Commercial design with ease of household unit installation Standard mounting included-fits standard 3 1/2 - 4" sink opening. Automatic reversing motor Full 1 year warranty

| FIG. NO. | PRICE |
|----------|-------|
| 61311 | |

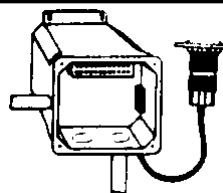

ISE AIR CONTROL SWITCH Simplifies first time electrical installation Push button mounts on sink or counter Operates on 120V current

| FIG. NO. | PRICE |
|----------|-------|
| 61309 | |



ISE H770 - Provides up to 60 cups of hot water an hour at 190°

| FIG. NO. | PRICE |
|----------|-------|
| 7877 | |



High cushion disposal drain seal. Fits Insinkerator, Bus-boy, Whirl-A-Way, For garbage disposal drain elbow.

| FIG. NO. | PRICE |
|----------|-------|
| 14775 | |



Kitchen sink and garbage disposal stopper, Vinyl with knob, flanged to fit all sizes, Designed with stay-put lip to prevent slipping and can be used in basket strainers and garbage disposals.

| FIG. NO. | PRICE |
|----------|-------|
| 14844 | |



The ISE Septic Disposer - Specially designed to work with any size septic system.

| FIG. NO. | PRICE |
|----------|-------|
| 85841 | |

Bio-Charge Enzyme Treatment

| FIG. NO. | PRICE |
|----------|-------|
| 87750 | |



Garbage disposal splash guard, snap fits all makes of disposals, with snap ring for holding in place.



Garbage disposal elbow

| FIG. NO. | PRICE |
|----------|-------|
| Guard | 14843 |
| Elbow | 19131 |

COMMERCIAL DISPOSERS

DUFF COMPANY OFFERS A COMPLETE LINE OF INSINKERATOR COMMERCIAL DISPOSERS 1/2 HP THRU 10 HP.

WE CAN ADAPT TO MANY BRANDS, INCLUDING WASTE KING, NATIONAL, RED GOAT, FMC, AVANT, BUS BOY, AMERICAN DELPHI, ATOMIC, SALVAJOR, HOBART, GE, AND MASTER!

FEATURES:

- *Corrosion resistant stainless steel.
- *3/4" rubber mounting above grind chamber isolates sound and eliminates vibration.
- *Induction motor totally enclosed to provide protection against outside moisture. Controlled power air flow cools motor for efficiency and longer life.
- *Stationary and rotating shredding elements made from cast nickel chrome alloy for long life and corrosion resistance, designed for reverse action grinding
- *All stainless steel and chrome plated. Paint-free for lasting sanitation.

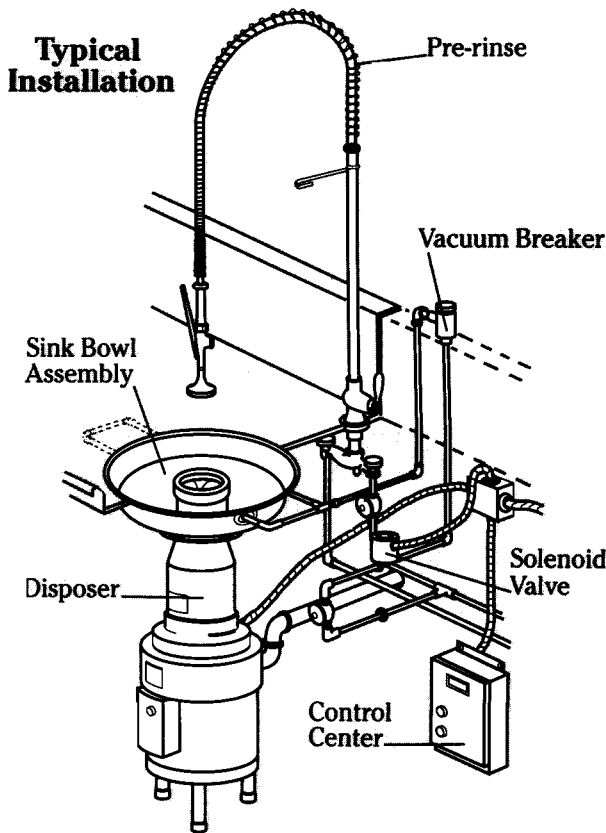

"WHETHER YOU SERVE 25 OR 2500 PEOPLE, THERE'S AN INSINKERATOR DISPOSER THAT'S RIGHT FOR YOU!"



| Recommended Sizing Chart* | | | | | |
|---------------------------|-------------------|----------------------|------------------|----------|-----------------|
| Persons Per Meal | Soiled Dish Table | Vegetable Prep. Area | Salad Prep. Area | Pot Sink | Meat Prep. Area |
| Up to 100 | SS-75 | SS-50 | — | — | — |
| 100—150 | SS-100 | SS-75 | SS-50 | SS-50 | — |
| 150—175 | SS-125 | SS-100 | SS-75 | SS-50 | SS-150 |
| 175—200 | SS-150 | SS-150 | SS-75 | SS-75 | SS-150 |
| 200—300 | SS-200 | SS-150 | SS-75 | SS-75 | SS-300 |
| 300—750 | SS-300 | SS-150 | SS-75 | SS-75 | SS-300 |
| 750—1500 | SS-500 | SS-300 | SS-150 | SS-150 | SS-500 |
| 1500—2500 | (2) SS-500 | SS-300 | SS-150 | SS-150 | SS-500 |

2500-over, contact your DUFF REPRESENTATIVE.

For special applications such as supermarkets or other heavy continuous volume installations, select model SS-750 or SS-1000.

*The models listed are the minimum size INSINKERATOR to be used at the point-of-origin for food wastes. Sizing recommendations re given in general terms. Actual capacities vary depending on the type of food waste.

HEATING

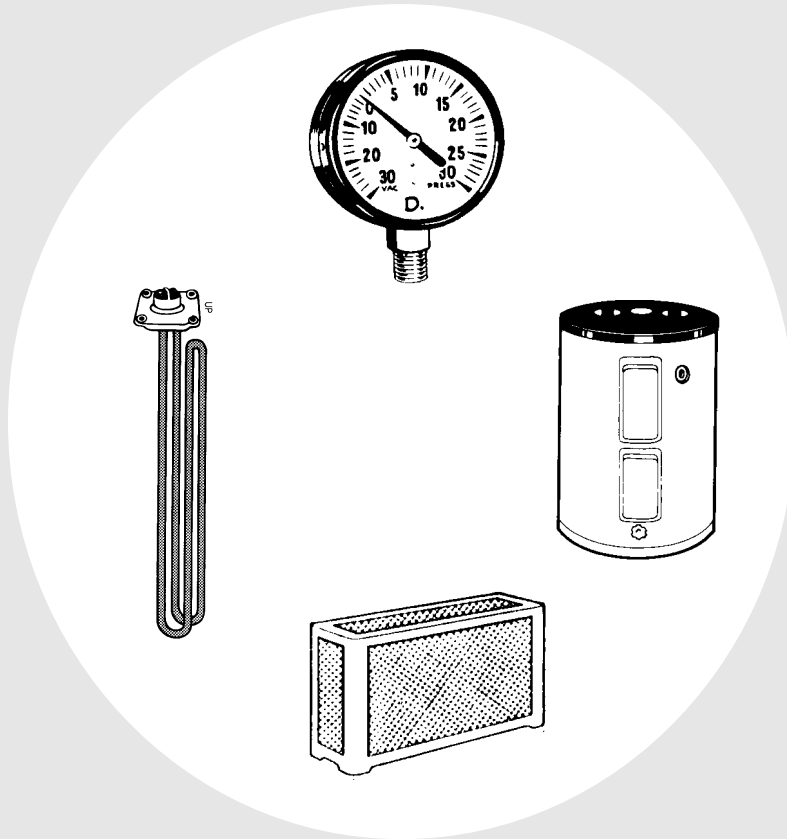

HEATING

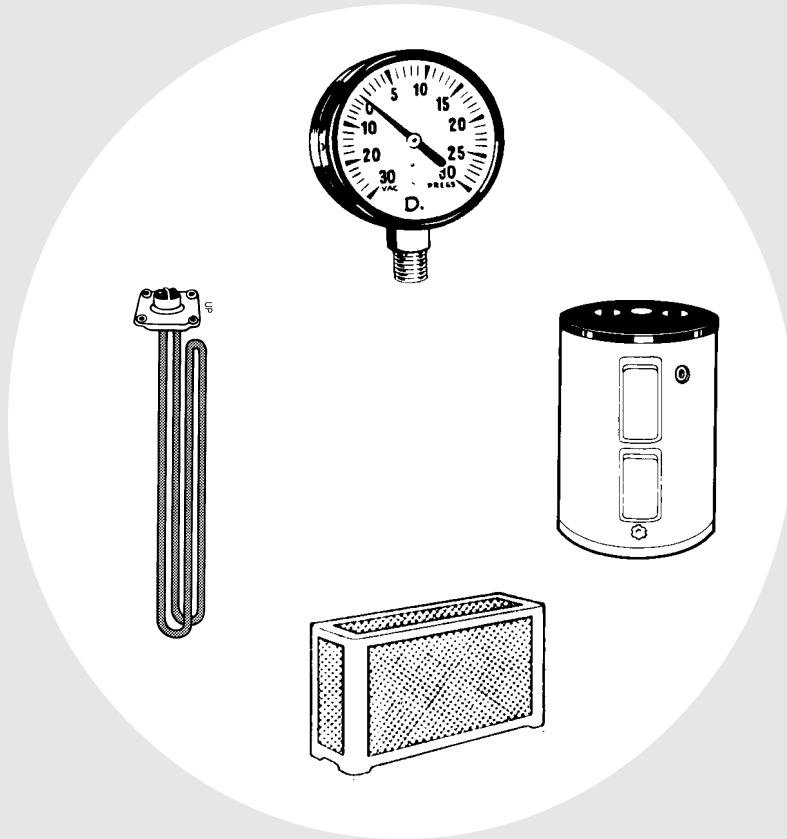

DUFF OFFERS A COMPLETE LINE OF CUSTOM AND REPLACEMENT TUBE BUNDLES AND COILS FOR ALL YOUR REPLACEMENT AND NEW WORK NEEDS.

TAPERED TUBE PLUGS FOR REPAIRING HEAT EXCHANGERS & BOILERS. 1/4" THROUGH 1 1/4" READILY AVAILABLE. SOLD IN PACKS OF 24.

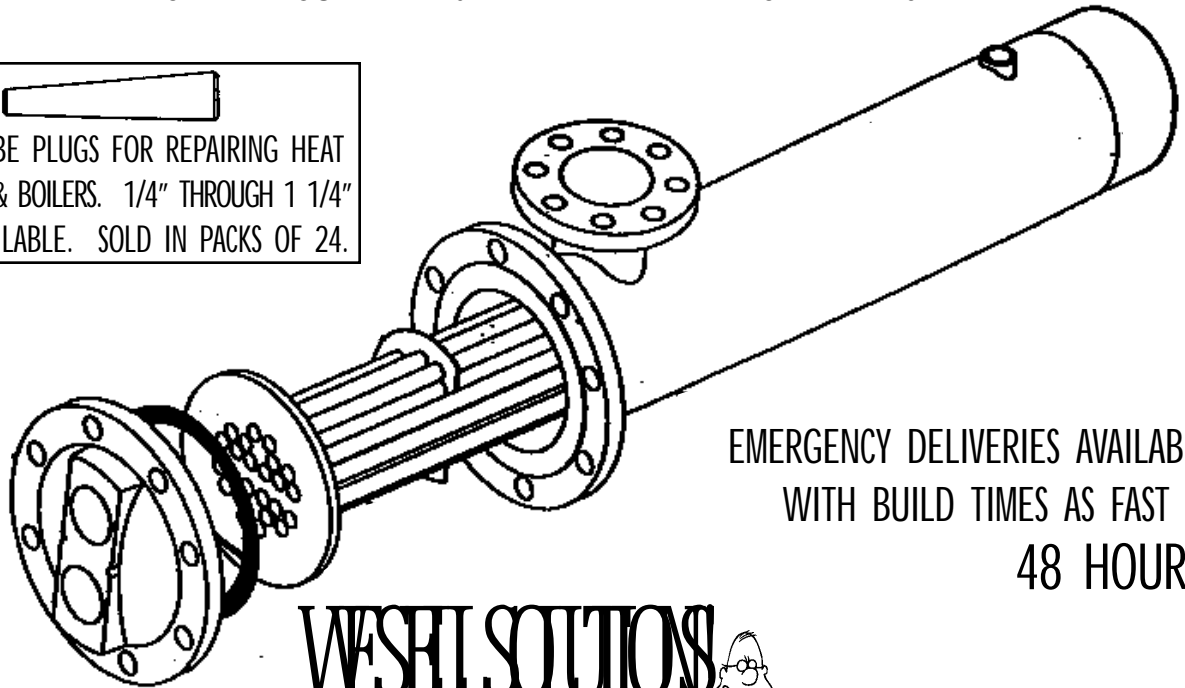

EMERGENCY DELIVERIES AVAILABLE WITH BUILD TIMES AS FAST AS 48 HOURS!

WESHSOLUTIONS



B&G
ARMSTRONG
TACO
AMTROL
TRANE
CARRIER
McQUAY

...AND MANY MORE!

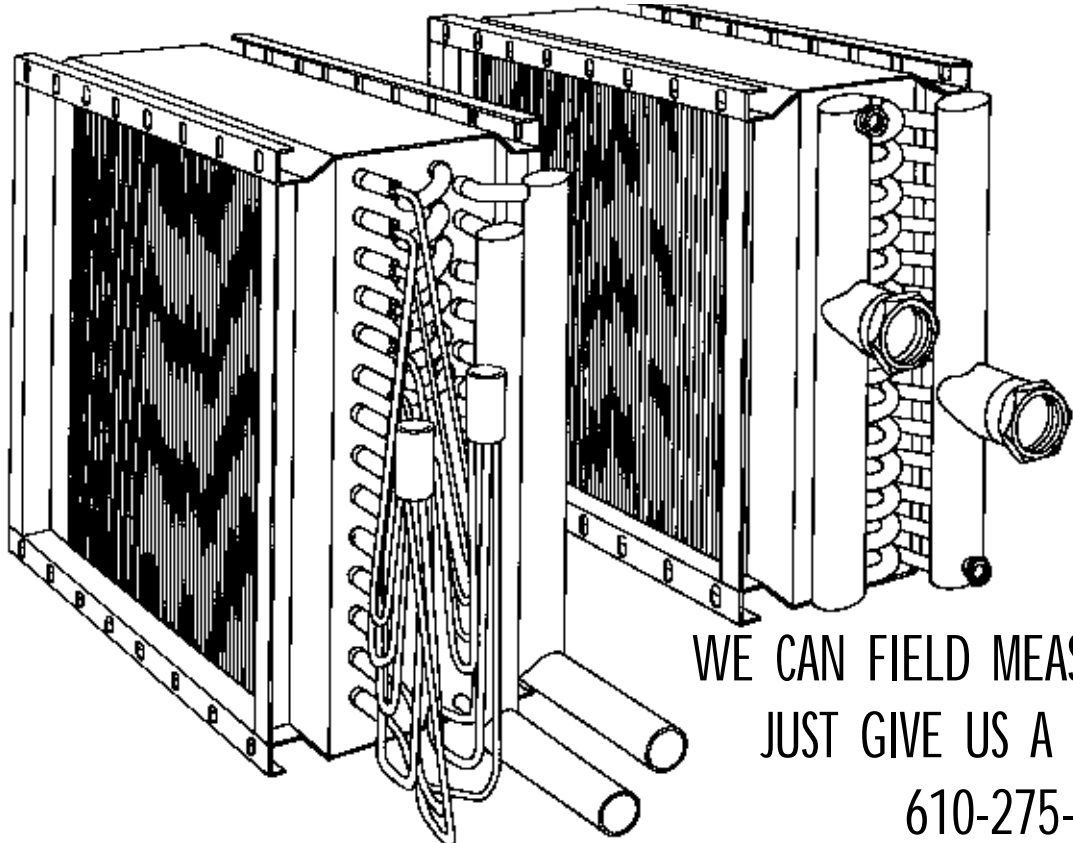

WE CAN FIELD MEASURE!
JUST GIVE US A CALL!
610-275-4453

DUFF WATER HEATERS
COMMERCIAL OR RESIDENTIAL
GAS OR ELECTRIC



For your Gas or Electric Water Heater requirements, contact your DUFF representative
PHONE: 610-275-4453
FAX: 610-279-6299

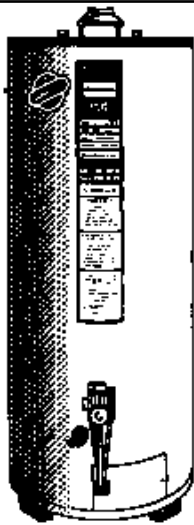

GAS WATER HEATERS
RESIDENTIAL GAS

6 YEAR WARRANTY ENERGY SAVER

10 YR WARRANTY AVAILABLE!

1" non-CFC foam insulation, vitraglas lining, Factory installed dielectric waterway fittings, Protective magnesium anode rod, Factory installed Hydrojet total performance system, Fully automatic control, T&P relief valve opening on side of tank.



| Gal Capacity | BTU input | GPH Rec. 90oF Rise | Style | Floor to flue conn | Jacket Dia. | Vent Size | Fig. No. | Price |
|--------------|-----------|--------------------|----------|--------------------|-------------|-----------|----------|-------|
| 30 | 32,000 | 33 | Tall | 59 1/4" | 16" | 3" | 8350 | |
| 30 | 30,000 | 31 | Short | 48 1/4" | 18" | 3" | 8293 | |
| 40 | 40,000 | 41 | Tall | 61 1/2" | 18" | 3" | 8356 | |
| 40 | 40,000 | 41 | Short | 51" | 20" | 3" | 8297 | |
| 50 | 40,000 | 41 | Standard | 60 1/4" | 20" | 3" | 8303 | |
| 65 | 65,000 | 68 | Standard | 64 1/2" | 22" | 4" | 68248 | |
| 75 | 75,000 | 76 | Standard | 63 3/4" | 24 1/2" | 4" | 8330 | |
| 100 | 88,000 | 90 | Tall | 68 11/16" | 28 1/4" | 4" | 61229 | |

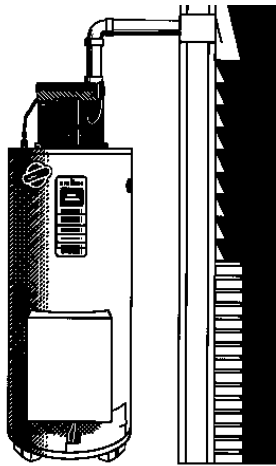

RESIDENTIAL THROUGH THE WALL GAS

6 YEAR WARRANTY

Power vented for positive exhaust. 1" non-CFC foam insulation, Intermittent pilot ignition system - no standing pilot, Can be vented both horizontally and vertically, Vitraglas lining, Protective magnesium anode rod, Factory installed dielectric waterway fittings, Factory installed Hydrojet total performance system, Fully automatic controls, T&P relief valve opening on side of tank, Slider combustion chamber door.

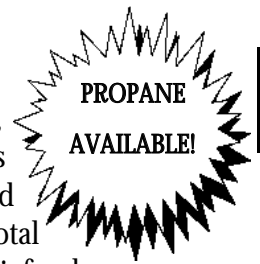

10 YR WARRANTY AVAILABLE!

| FIG. NO. | NATURAL GAS | | | HEIGHT | JACK DIA | VENT SIZE | PRICE |
|----------|-------------|-----------|--------------------|---------|----------|-----------|-------|
| | GAL. CAP. | INPUT BTU | GPH rec 90° F rise | | | | |
| 50793 | 38 | 40000 | 43 | 57 3/4" | 20" | 2" | |
| 43282 | 48 | 40000 | 42 | 58 3/4" | 22" | 2" | |

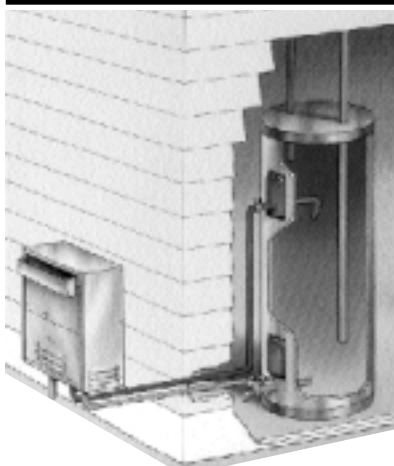

ENERGY SAVER
GAS MODEL FOR OUTDOOR USE
5 YEAR WARRANTY

Out door installation only. T&P relief valve installed. Circulating pump installed. Freeze protection provided. Intermittent pilot ignition. 110 volt AC required.



| KW input | BTU input | Height | Width | Depth | Height to top of vent kit | Gas Conn. | Water Conn. | Fig. No. | Price |
|----------|-----------|--------|-------|-------|---------------------------|-----------|-------------|----------|-------|
| 18 | 60,000 | 28" | 18" | 15" | 29 3/4" | 1/2" | 1/2" | 8263 | |

ELECTRIC WATER HEATERS

RESIDENTIAL ELECTRIC WATER HEATER

6 YEAR WARRANTY

ENERGY SAVER

1" Non-CFC foam insulation, Vitraglas lining, Factory installed dielectric waterway fittings with heat traps, protective magnesium anode rod, Factory installed Hydrojet total performance system, Direct heat transfer

with immersed screw-type elements, T&P relief valve opening on top of tank.



| FIG. NO. | GAL CAP | JACKET DIA | HEIGHT | APPROX SHIP WT |
|----------|---------|------------|---------|----------------|
| 8493 | 30 | 16" | 46 1/2" | 80 |
| 8496 | 40 | 18" | 46 3/4" | 96 |
| 8500 | 50 | 20" | 46 1/4" | 119 |
| 8503 | 65 | 20" | 58 3/4" | 146 |
| 8505 | 80 | 22" | 58 3/4" | 174 |

LOW BOY ELECTRIC WATER HEATER

CAN BE USED UNDERCOUNTER

WITH SAME FEATURES AS FULL SIZE HEATER ABOVE!

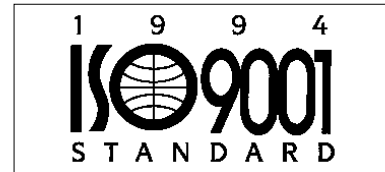
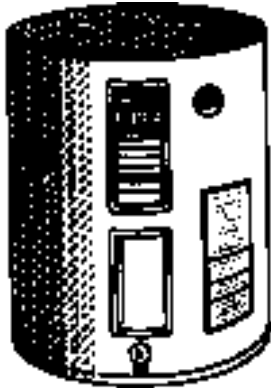

| FIG. NO. | GALLON CAPACITY | JACKET DIA | HEIGHT | APPROX SHIP WT | PRICE |
|----------|-----------------|------------|---------|----------------|-------|
| 8508 | 30 | 20" | 29 1/2" | 86 | |
| 8511 | 40 | 22" | 31 1/2" | 115 | |

TABLE TOP ELECTRIC WATER HEATER

ENERGY SAVER

6 YEAR WARRANTY

**GLASS LINED - PROTECTIVE
MAGNESIUM ANODE ROD**

FULLY AUTOMATIC CONTROL - 1" DENSITY FIBERGLASS INSULATION

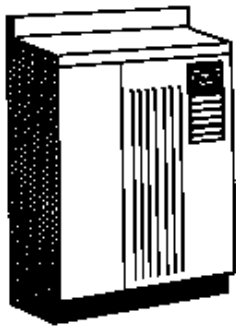

WITH SAME FEATURES AS FULL SIZE HEATER ABOVE!

| FIG. NO. | GALLON CAPACITY | JACKET DIM | FLOOR TO WATER CONN | JACKET HEIGHT | APPROX SHIP WT | PRICE |
|----------|-----------------|------------|---------------------|---------------|----------------|-------|
| 83948 | 38 | 24"X25" | 33 1/4" | 36" | 125 | |

UTILITY ELECTRIC WATER HEATER

7 GPH RECOVERY 90° F RISE

**FOR USE IN SMALL OFFICE, GAS STATIONS, SMALL STORES
FOR LIMITED USAGE! STOCK 120 VOLT, SPECIFY FOR 220 VOLT**

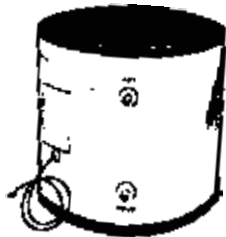

| FIG. NO. | GALLON CAPACITY | JACKET DIA | HEIGHT | APPROX SHIP WT | PRICE |
|----------|-----------------|------------|-----------|----------------|-------|
| 8459 | 6 | 14" | 16" | 33 | |
| 8486 | 12 | 14" | 27 13/16" | 48 | |
| 8489 | 19 | 18" | 24 7/8" | 59 | |

WITH SAME FEATURES AS FULL SIZE HEATER ABOVE!

ELECTRIC WATER HEATERS

WALL HUNG ELECTRIC UTILITY WATER HEATER
 1.5 kw 7 gph RECOVERY



1" Non-CFC foam insulation surrounds the tank surface, Factory installed heavy duty wall mounting bracket, Factory installed dielectric waterway fittings, Fully automatic controls, Direct heat transfer with immersed screw-type elements, Vitraglas lining, Protective magnesium anode rod, T&P relief valve opening on side of tank.

| FIG. NO. | GALLON CAPACITY | HEIGHT | DIAMETER | WALL TO FRONT | APPROX SHIP WT. | PRICE |
|----------|-----------------|---------|----------|---------------|-----------------|-------|
| 61282 | 6 | 15 3/4" | 14" | 14 5/8" | 33 | |
| 61283 | 12 | 16 3/8" | 18" | 18 5/8" | 47 | |
| 61284 | 19 | 24 3/8" | 18" | 18 5/8" | 58 | |
| 61285 | 30 | 29 1/4" | 20" | 20 5/8" | 86 | |

COMPACT ELECTRIC WATER HEATER
 2 GALLON CAPACITY 7 GPH RECOVERY UT 14LB



Ideal for use wherever remote hot water is needed - in offices, store, work stations, etc, Extremely compact (12 1/2" x 9" x 10 1/4"), handsome and easy to install, Operated on ordinary house current (110-120 volts - 1500 watts) 15 AMPS required, Temperature range of 110^o - 160^oF., Deep drawn steel tank with exclusive Vitraglas lining, corrosion proof outer jacket, Fully automatic controls, 4' cord includes 3-prong, grounded plug

| FIG. NO. | GALLON CAPACITY | HEIGHT | WIDTH | DEPTH | APPROX SHIP WT. | PRICE |
|----------|-----------------|---------|-------|---------|-----------------|-------|
| 43370 | 2 | 12 1/2" | 9" | 10 1/4" | 14 | |

SOLAR MODEL WATER HEATER

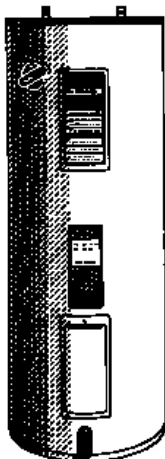

2" Non-CFC foam insulation, Vitraglas lining, Factory installed dielectric waterway fittings, Factory installed Hydroject total performance system, Side T&P relief valve opening, Thermal feet, Pre-wired sensor lead, Top of tank access for wiring and water connections. Insulated storage tank with electric element and thermostat, Triple-tested, heavy gauge steel tank.

| FIG. NO. | GALLON CAPACITY | JACKET DIA | HEIGHT | APPROX SHIP WT. | PRICE |
|----------|-----------------|------------|---------|-----------------|-------|
| 61288 | 65 | 22" | 58 3/4" | 165 (168) | |
| 61289 | 80 | 24" | 58 3/4" | 210 (213) | |
| 61290 | 119 | 128" | 62 1/2" | 310 (313) | |

**DUFF IS A PROUD DISTRIBUTOR
 OF BRADFORD-WHITE WATER
 HEATERS AND THE COMPLETE BRAD-
 FORD-WHITE LINE!**



For additional information call: 610-275-4453 or Fax: 610-279-6299
 Please call for current prices.

COMMERCIAL WATER HEATERS

COMMERCIAL GAS WATER HEATER

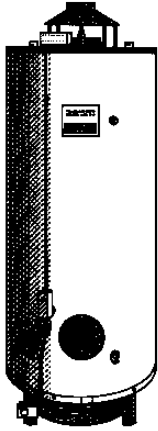

VITRAGLASS LINED TANK.
 AUTOMATIC FLUE DAMPER REDUCES STANDBY LOSS
 SPARK IGNITION ELIMINATES CONSTANT PILOT
 DUAL ANODE ROD FOR EXTRA LONG LIFE
 3 YEAR LIMITED WARRANTY
 R VALUE 16

**NSF AVAILABLE
 ON SEVERAL
 MODELS OF
 WATER
 HEATERS!**



| FIG. NO. | NAT & LP INPUT BTU | 1ST HOUR DEL. GAL AT 100° F RISE | STG CAP US GAL | HEIGHT | DIAMETER | VENT DIAME- TER | WATER CONN | WEIGHT | PRICE |
|----------|-----------------------|--|----------------------|--------|----------|--------------------|---------------|--------|-------|
| 50071 | 199,999 | 250 | 80 | 64 1/2 | 28 1/4 | 6 | 1 1/2 | 540 | |
| 50072 | 199,999 | 263 | 98 | 75 1/2 | 28 1/4 | 6 | 1 1/2 | 610 | |

COMMERCIAL WATER HEATER ENERGY SAVER

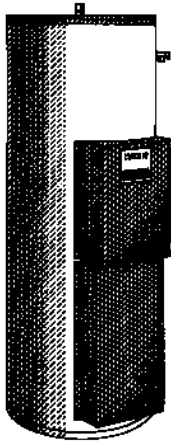

Vitraglas lined tank, Dual anodic protection against galvanic corrosion, 3" Non-CFC foam insulation, Completely pre-wired, Factory installed 3/4" relief valve, Hand hole cleanout opening.
SPECIFY KW INPUT!



| FIG. NO. | GALLON CAPACITY | DIAMETER | HEIGHT | APPROX SHIP WEIGHT | PRICE |
|------------|--------------------|----------|--------|-----------------------|-------|
| 61293 | 50 | 24 | 47 3/4 | 270 | |
| 61294 | 80 | 26 | 60 1/4 | 335 | |
| 61295 | 119 | 30 1/4 | 64 1/2 | 430 | |
| 61296 ASME | 119 | 30 1/4 | 64 1/2 | 485 | |

COMMERCIAL ENERGY SAVER STORAGE TANK

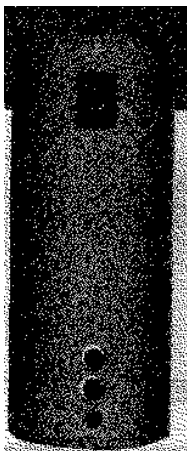

Meets ASHRAE 90.1b 1992, 2" Non-CFC foam insulation, Vitraglas lined tank, Factory installed dielectric waterway fittings, Two magnesium anode rods, Handhole cleanout, Solid brass drain valve, 2" water connection.



| FIG. NO. | RATED GALLON CAPACITY | DIAMETER | HEIGHT | APPROX SHIP WEIGHT | PRICE |
|----------|-----------------------------|----------|---------|-----------------------|-------|
| 57496 | 119 | 28" | 62 1/2" | 312 | |

COMMERCIAL WATER HEATERS

OIL FIRED COMMERCIAL WATER HEATER

6 YEAR WARRANTY

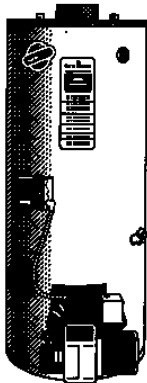

Oil heats water 3 to 4 times faster than other fuels, resulting in high recovery rates, Factory installed dielectric waterway fittings, Factory installed Hydroject total performance system, Protective anode rod, Easy-space saving installation, 1" Non-CFC foam insulation.



| FIG. NO. | TANK STORAGE CAPACITY GALLONS | RECOMMENDED FIRING RATE GPH NO. 2 OIL | RECOVERY AT RECOMMENDED FIRING RATE GPH | PRICE |
|----------|-------------------------------|---------------------------------------|---|-------|
| 61298 | 32 | .65 | 91 | |
| 61299 | 50 | .75 | 107 | |

COMBICOR GAS FIRED ENERGY SAVER WATER HEATER

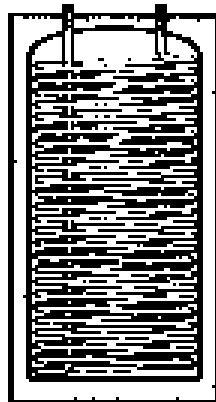
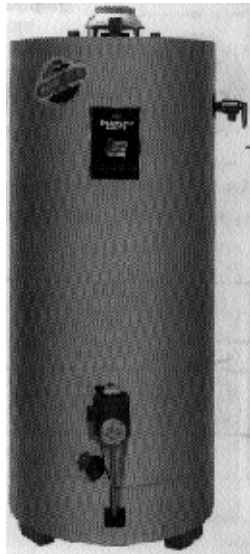

Direct fired combination water heater and boiler. Vitraglas lining, magnesium anode rod, factory installed hydrojet system, ultracoil heat exchanger, anti-scald device supplied, 10 year tank warranty, cast iron burner, especially suited for radiant heat and base board applications. Home heating and domestic hot water combined.



| FIGURE NUMBER | INPUT BTU | GALLON CAP | HEIGHT | DIA | VENT DIA | APPROX SHIP WT | PRICE |
|---------------|-----------|------------|---------|-----|----------|----------------|-------|
| 61363 | 65000 | 46.5 | 57 1/4" | 22" | 4 | 169 | |
| 61364 | 80000 | 73.5 | 60 1/4" | 26" | 4 | 303 | |

COMBICOR OIL FIRED ENERGY SAVER WATER HEATER

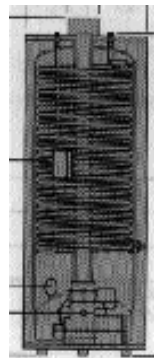
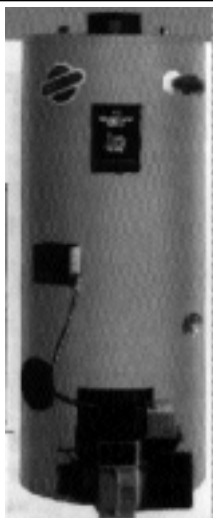

Direct fired combination water heater and boiler. Vitraglas lining, magnesium anode rod, factory installed hydrojet system, ultracoil heat exchanger, anti-scald device supplied, Becket AF burner single or two stage, 6 year tank warranty. Home heating and domestic hot water combined.



| FIGURE NUMBER | INPUT BTU | GALLON CAP | HEIGHT | DIA FLUE OUTLET | APPROX SHIP WT | PRICE |
|---------------|-----------|------------|--------|-----------------|----------------|-------|
| 61365 | 10400 | 48.5 | 61 | 6 | 209 | |
| 61366 | 138500 | 68.5 | 66 3/4 | 6 | 299 | |

COMPACT



ALL MODELS INCLUDE:
 CASTONE® TANK, LOW-WATER CUT-OFF (LWC), Temperature/Pressure Relief Valve, Cast Iron Pressure Reducing Valve, two Temperature/Pressure Gauges, Pilot Light and On-Off Switch. Deduct \$80 for Low-Water Cut-Off, \$40 for Pressure Reducing Valve and \$40 for each Temperature/Pressure Gauge if not required. Make note of deduction on purchase order.

BOOSTERS IMPERIAL

ALL MODELS INCLUDE:
 CASTONE® TANK, LOW-WATER CUT-OFF (LWC), Temperature/Pressure Relief Valve, Cast Iron Pressure Reducing Valve, two Temperature/Pressure Gauges, Pilot Light and On-Off Switch. Deduct \$80 for Low-Water Cut-Off, \$40 for Pressure Reducing Valve and \$40 for each Temperature/Pressure Gauge if not required. Make note of deduction on purchase order.



Imperial Model S
 16 gallon (61 liters) storage capacity

| Compact Model | SPECIFICATIONS | |
|---------------|--------------------|--------------------|
| | 40°F. (22°C) Rise | 70°F. (30°C) Rise |
| C-4 | 40 gph (151 lph) | 23 gph (87 lph) |
| C-5 | 50 gph (189 lph) | 29 gph (110 lph) |
| C-6 | 60 gph (227 lph) | 34 gph (128 lph) |
| C-7 | 70 gph (265 lph) | 40 gph (151 lph) |
| C-9 | 90 gph (341 lph) | 52 gph (197 lph) |
| C-12 | 120 gph (454 lph) | 68 gph (261 lph) |
| C-13 | 135 gph (511 lph) | 77 gph (282 lph) |
| C-15 | 151 gph (572 lph) | 86 gph (326 lph) |
| C-17 | 173 gph (655 lph) | 99 gph (375 lph) |
| C-18 | 181 gph (685 lph) | 103 gph (390 lph) |
| C-24 | 241 gph (912 lph) | 138 gph (522 lph) |
| C-27 | 271 gph (1026 lph) | 155 gph (587 lph) |
| C-30 | 301 gph (1139 lph) | 172 gph (651 lph) |
| C-36 | 361 gph (1367 lph) | 206 gph (780 lph) |
| C-39 | 391 gph (1480 lph) | 224 gph (848 lph) |
| C-45 | 452 gph (1711 lph) | 258 gph (977 lph) |
| C-54 | 542 gph (2052 lph) | 310 gph (1174 lph) |
| C-58 | 588 gph (2225 lph) | 335 gph (1268 lph) |

| Imperial Model | SPECIFICATIONS | |
|----------------|--------------------|--------------------|
| | 40°F. (22°C) Rise | 70°F. (30°C) Rise |
| S-6 | 60 gph (227 lph) | 34 gph (129 lph) |
| S-7 | 70 gph (265 lph) | 40 gph (151 lph) |
| S-9 | 90 gph (341 lph) | 52 gph (197 lph) |
| S-12 | 120 gph (454 lph) | 69 gph (261 lph) |
| S-13 | 135 gph (511 lph) | 77 gph (282 lph) |
| S-15 | 151 gph (572 lph) | 86 gph (326 lph) |
| S-17 | 173 gph (655 lph) | 99 gph (375 lph) |
| S-18 | 181 gph (685 lph) | 103 gph (390 lph) |
| S-24 | 241 gph (912 lph) | 138 gph (522 lph) |
| S-27 | 271 gph (1026 lph) | 155 gph (587 lph) |
| S-30 | 301 gph (1139 lph) | 172 gph (651 lph) |
| S-36 | 361 gph (1367 lph) | 206 gph (780 lph) |
| S-39 | 391 gph (1480 lph) | 224 gph (848 lph) |
| S-40 | 407 gph (1541 lph) | 232 gph (878 lph) |
| S-45 | 452 gph (1711 lph) | 258 gph (977 lph) |
| S-54 | 542 gph (2052 lph) | 310 gph (1174 lph) |
| S-58 | 588 gph (2225 lph) | 335 gph (1268 lph) |

SANITIZING

For 3 or 4 compartment sinks or pot and pan sinks. All models include stainless steel front, silver gray hammer-tone body and black base. Drain may be connected to open-sight waste drain.
 A special 3CS Sink Heater is available for shipboard use under military spec. #MH-H-43895B. Consult factory for prices.



| Model | KW* | Phase | Sink Area | Ship. Wt. |
|---------|-----|---------|-------------------------|-----------------|
| 3CS-3 | 3 | 1 | 15" (38 cm) Sq. or less | 24 lbs. (11 kg) |
| 3CS-4 | 4.5 | 1 | 18"-18" (41-46 cm) Sq. | 24 lbs. (11 kg) |
| 3CS-6 | 6 | 1 or 3* | 19"-21" (48-53 cm) Sq. | 27 lbs. (12 kg) |
| 3CS-9 | 9 | 1 or 3* | Over 21" (53 cm) Sq. | 27 lbs. (12 kg) |
| 3CS-3BT | 3 | 3 | 15" (38 cm) Sq. or less | 30 lbs. (14 kg) |
| 3CS-4BT | 4.5 | 3 | 18"-18" (41-46 cm) Sq. | 30 lbs. (14 kg) |
| 3CS-6BT | 6 | 3 | 19"-21" (48-53 cm) Sq. | 30 lbs. (14 kg) |
| 3CS-9BT | 9 | 3 | Over 21" (53 cm) Sq. | 30 lbs. (14 kg) |

INSTALLATIONS

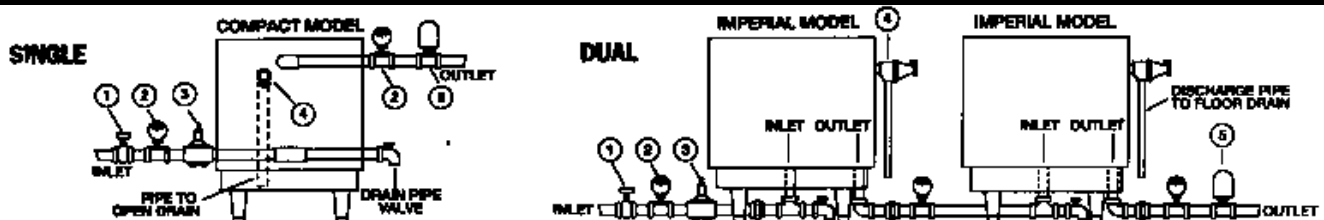

(1) ½" (2 cm) Shut-off Valve* (2) T/P Gauge (3) Pressure Reducing Valve w/By-Pass (4) Relief Valve (5) Shock Absorber
 *Must be included in heater installation in order to drain heater for service. Must be a gate or ball valve.

CONSULT LOCAL CODES

COMMERCIAL WATER HEATER SIZING CHECKLIST

Use this handy sizing checklist for obtaining the information necessary to size the commercial water heater installation under consideration. The data collected can be used for your own reference in sizing...or simply give it to your Duff Salesperson who

RESTAURANT CHECKLIST

- 1. Number of meals served daily?
2. Required water temperature in F?
3. Brand and model number of dishwasher(s)?
4. Length of dishwashing cycle: 1 hour 2 hours 3 hours
5. Number of vegetable sinks?
6. Prescraper? YES NO Open-type Other
7. Preflusher? YES NO
8. Pot Sinks? YES NO
9. Number of Bar Sinks?
10. Number of Washrooms?

- 11. Pot Washer?
12. Model # and Manufacturer of current water heating equipment?
13. Is there a pressure reducing valve on dishwasher? YES NO

LAUNDRY CHECKLIST

MACHINE TYPE #1 MACHINE TYPE #2 MACHINE TYPE #3
Model number clothes washers?

- 1a. Number of clothes washers?
b. Gallons of fill water?
c. Required water temperature in F?
d. Length of (1) cycle
e. Cycles per hour

HOSPITALS AND NURSING HOMES

- 1. Kitchen (refer to restaurant checklist)
2. Laundry (refer to laundry checklist)
3. Special Needs:
a. No. of therapeutic baths?
c. Time of day usage?
b. No. of baths/hour?
d. No. of bedpan sanitizers?

BLEACHING REQUIREMENTS

- 2a. Gallons of 180 F water/hr req'd for bleaching

DORMITORY CHECKLIST - Shower Load

- 1. Woman's Dorm? YES NO
2. Men's Dorm? YES NO
3. Co-Ed Dorm? YES NO

- 4. Number of Females
5. Number of Males
NOTE: Hot water loads for laundry operations should be considered separately. Time of day for this usage must be determined as they effect the system sizing. Refer to laundry sizing checklist.

SCHOOL CHECKLIST - Shower Load

- 1. No. of showers?
2. Time period between gym classes?
hrs. Sizing will be based on
3 GPM mixed water shower flow rate.

Cafeteria Load-Hot water requirements in school cafeterias are generally 30% less per pupil than the per person average of a restaurant. By reducing the figure used for the total number students served by 30%, the restaurant checklist may then be used. Maintenance of Hot Water-The building cleaning load occurs at a time when the showers and/or cafeteria are not normally in use. This hot water demand is less than either of these loads and need not be considered in sizing.

SWIMMING POOL CHECK LIST

- 1. Square Feet of Pool, or, what is volume in gallons of pool.
2. Desired pool water temp?
3. Average temp difference at which the pool is to be used (ambient temp. vs. pool temp.) F

APARTMENT CHECK LIST

- 1. No. of Apartments?
2. Actual No. of people?
3. Laundry (refer to laundry check list)?
4. Current water heating equipment?
Model No.
Make

CARWASH

- 1. Call Duff Co.

CUSTOMER NAME:

ADDRESS

RECOMMENDED WATER HEATER: BTU or kw

RECOMMENDED STORAGE TANK:

SYSTEM RECOMMENDED:

WATER HEATER ACCESSORIES

ELEMENTS

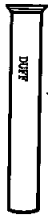

Water Heater Dip Tube

| FIG. NO. | PRICE |
|----------|-------|
| 8719 | |



Water Heater Drip Pans.

| POLYETHYLENE | | |
|--------------|----------|-------|
| SIZE | FIG. NO. | PRICE |
| 24" | 73938 | |
| 30" | 8721 | |
| ALUMINUM | | |
| SIZE | FIG. NO. | PRICE |
| 20" | 51156 | |
| 26" | 51157 | |

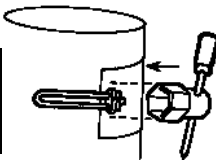

Water Heater Element Wrench

| FIG. NO. | PRICE |
|----------|-------|
| 8718 | |

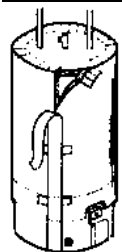

Water Heater Insulation Jacket

| FIG. NO. | PRICE |
|----------|-------|
| 8691 | |



Drain Valves - 3/4" tank opening with 3/4" hose connection with 1 1/4" shank.

| FIG. NO. | PRICE |
|----------|-------|
| 8722 | |

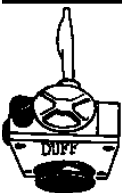

Natural Gas Control - Natural Gas Only. 1.2" IPS gas inlet by 1/2" flare outlet, shank length 1 1/4", 4.0" water column, adjustable from 120-160°

| FIG. NO. | PRICE |
|----------|-------|
| 8716 | |



Lower Thermostat

UL listed, 1 yr warranty, energy efficient range setting Built in safety switch to prevent overheating. Adjustable temperature range 110°-170°

| FIG. NO. | PRICE |
|----------|-------|
| 8712 | |

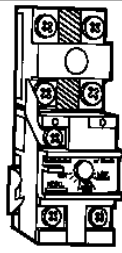

Upper Thermostat

UL listed, 1 yr warranty, energy efficient range setting Built in safety switch to prevent overheating. Adjustable temperature range 110° -170°

| FIG. NO. | PRICE |
|----------|-------|
| 8713 | |

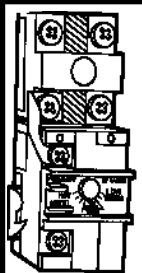

One element Thermostat

| FIG. NO. | PRICE |
|----------|-------|
| 8715 | |

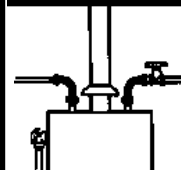

Stainless Braided Flexible Water heater connectors.

| FIG. NO. | PRICE |
|----------|-------|
| 45398 | |



Watts 100XL - Domestic Hot water Heater Relief Valve.

| FIG. NO. | PRICE |
|----------|-------|
| 3756 | |

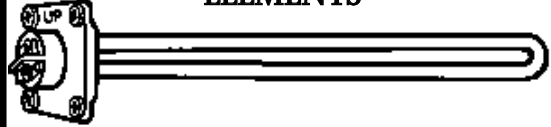

Universal Flange - replaces flat or round head elements. Kit contains 1 element, 2 gaskets. 4 Bolt immersion element (2 1/2" diagonal bolt hole center)

| DESCR | FIG. NO. | PRICE |
|------------|----------|-------|
| 1500W 120V | 8742 | |
| 2000W 120V | 8748 | |
| 1500W 240V | 8751 | |
| 2000W 240V | 8754 | |
| 2500W 240V | 8756 | |
| 4500W 240V | 8761 | |
| 6000W 240V | 8763 | |
| 4500W 480V | 48952 | |

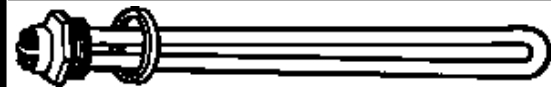

SCREW-IN Immersion Elements - FITS: Kelvinator, Montgomery Ward, Norge, Intertherm, Rheem, Rudd. Westinghouse changed to this type in 1963. State changed to this type in July, 1975.

| DESCR | FIG. NO. | PRICE |
|------------|----------|-------|
| 1500W 120V | 8727 | |
| 2000W 120V | 8728 | |
| 1500W 240V | 8731 | |
| 2000W 240V | 8732 | |
| 2500W 240V | 8733 | |
| 3500W 240V | 8735 | |
| 4500W 240V | 8736 | |
| 6000W 240V | 8738 | |
| 6000W 480V | 38011 | |

Lime-Life Elements - Highest grade nickel and chromium incaloy, ultra low-watt density, heats in lime and build-ups that will burn out ordinary elements. Best where water has high mineral content.



| FIG. NO. | PRICE |
|----------|-------|
| 17674 | |



| FIG. NO. | PRICE |
|----------|-------|
| 17675 | |

ARUBA CAST IRON GAS FIRED HOT WATER BOILER



STANDARD EQUIPMENT INCLUDES: Standing pilot and vent damper, Completely factory assembled, pre-wired and crated with built-in draft diverter, Deluxe baked enamel steel jacket, 3/4" boiler drain, ASME relief valve (30 lb), 1 1/4 circulator wired and piped to boiler, One piece cast iron burners (natural gas only, Vent damper, Honeywell L8148E combination, High control and circulator relay, Honeywell automatic redundant combination gas valve, 24v with pilot filter, switches - one spill switch and one rollout switch

| MODEL/ FIG. NO. | NO. OF SPECS | NATURAL GAS AND LP GAS | | | APPROX SHIPPING WGHT PACKAGED | AFUE % | | PRICE |
|--------------------|--------------|------------------------|--------------------------------------|-------------------------------------|--|--------|------|-------|
| | | AGA INPUT BTU/HR | DOE HEATING CAPACITY BTU/HR | IBR NET WATER RAT- ING BTU/HR | | 'SPD' | 'ED' | |
| ABF38 | 2 | 37,500 | 30,000 | 26,000 | 213 | 80.0 | 81.4 | |
| ABF70 | 3 | 70,000 | 56,000 | 49,000 | 277 | 80.4 | 81.6 | |
| ABF105 | 4 | 105,000 | 84,000 | 73,000 | 336 | 80.4 | 81.5 | |
| ABF140 | 5 | 140,000 | 113,000 | 98,000 | 401 | 80.3 | 81.3 | |
| ABF175 | 6 | 175,000 | 141,000 | 123,000 | 468 | 80.2 | 81.1 | |
| ABF210 | 7 | 210,000 | 169,000 | 147,000 | 539 | 80.1 | 81.0 | |
| ABF245 | 8 | 245,000 | 198,000 | 172,000 | 592 | 80.0 | 80.8 | |
| ABF280 | 9 | 280,000 | 226,000 | 197,000 | 663 | 80.0 | 80.7 | |

JAMAICA CAST IRON GAS FIRED STEAM BOILER



STANDARD EQUIPMENT INCLUDES: Standing pilot and vent damper, Completely factory assembled, pre-wired and crated with built-in draft diver, Deluxe baked enamel steel jacket, Steam pressure gauge, 3/4" boiler drain, ASME pop safety valve set for r15 psi, PA-404A pressure-trol, One piece cast iron burners, Gauge glass set, Switches - one spill switch and one rollout switch, Low water cutoff (float type) mounted, Vent damper.

| MODEL/ FIG. NO. | NO. OF SPECS | NATURAL GAS | | | | PROPANE GAS | | | | APPROX SHIPPING WGHT PACKAGED | AFUE% 'SPD' | PRICE |
|--------------------|-----------------|------------------------|--------------------------------------|--------------------------------------|---------------------------------|------------------------|--------------------------------------|--------------------------------------|---------------------------------|--|----------------|-------|
| | | AGA INPUT BTU/HR | DOE HEATING CAPACITY BTU/HR | IBR NET WATER RATING BTU/HR | SQUARE FOOT RADI- TION | AGA INPUT BTU/HR | DOE HEATING CAPACITY BTU/HR | IBR NET WATER RATING BTU/HR | SQUARE FOOT RADI- TION | | | |
| JBF-32 | 3 | 75,000 | 62,000 | 74,000 | 196 | 70,000 | 57,000 | 42,000 | 178 | 317 | 81.1 | |
| JBF-42 | 4 | 112,000 | 91,000 | 68,000 | 283 | 105,000 | 85,000 | 64,000 | 267 | 393 | 78.8 | |
| JBF-52 | 5 | 150,000 | 122,000 | 92,000 | 383 | 140,000 | 114,000 | 86,000 | 358 | 465 | 79.2 | |
| JBF-62 | 6 | 187,000 | 153,000 | 115,000 | 479 | 175,000 | 143,000 | 107,000 | 446 | 539 | 79.6 | |
| JBF-72 | 7 | 225,000 | 183,000 | 137,000 | 571 | 210,000 | 171,000 | 128,000 | 553 | 629 | 80.1 | |
| JBF-82 | 8 | 262,000 | 215,000 | 161,000 | 671 | 245,000 | 200,000 | 150,000 | 625 | 706 | 80.5 | |
| JBF-92 | 9 | 299,000 | 245,000 | 184,000 | 767 | 280,000 | 229,000 | 172,000 | 717 | 786 | 80.9 | |

CXE GAS FIRED CAST IRON HOT WATER BOILER

HIGH EFFICIENCY

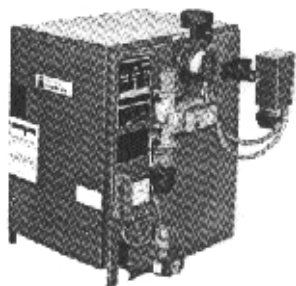

STANDARD EQUIPMENT INCLUDES: Completely factory assembled, Pre-wired and crated, 3"x4" increaser fitting and sealant, to adapt 3" fan outlet to 4" vent pipe, Honeywell L8148a, Honeywell AT140c, Flame rollout safety, Vacuum switch for proven air flow, Combination pressure/temperature gauge, 1 1/4" circulator isolation flanges, ASME relief valve (30 lb), Complete installed and wired gas control system with burner and manifold.



| MODEL | NO. OF SPECS | NATURAL GAS AND LP GAS | | | VENT DIAMETER (INCHES) | | FIG. NO. | APPROX. SHIPPING WEIGHT PACKAGED | DOE ANNUAL EFFICIENCY (AFUE) |
|-------|--------------|------------------------|-----------------------------|-----------------------------|----------------------------------|---------------------------------|----------|----------------------------------|------------------------------|
| | | AGA INPUT BTU/HR | DOE HEATING CAPACITY BTU/HR | IBR NET WATER RATING BTU/HR | MIN VENT TO CHIMNEY (CATEGORY 1) | HORIZONTAL VENTING (CATEGORY 2) | | | |
| CXE2 | 2 | 42,500 | 36,000 | 31,000 | 4 | 3 | 38720 | 220 | 84.4 |
| CXE3 | 3 | 75,000 | 63,000 | 55,000 | 4 | 3 | 38721 | 266 | 83.4 |
| CXE4 | 4 | 112,500 | 94,000 | 82,000 | 4 | 3 | 38722 | 321 | 83.0 |
| CXE5 | 5 | 150,000 | 125,000 | 109,000 | 4 | 3 | 38723 | 374 | 82.7 |
| CXE6 | 6 | 187,000 | 155,000 | 135,000 | 4 | 4 | 48818 | 432 | 82.3 |
| CXE7 | 7 | 225,000 | 186,000 | 162,000 | 4 | 4 | 48819 | 480 | 82.0 |

MEGASTORE STAINLESS STEEL INDIRECT WATER HEATER



The boiler that heats your home provides more energy while consuming fuel more efficiently than direct-fired domestic water heaters.

So **MEGA-STOR** saves on fuel costs by using hot water from your boiler to heat water for your showers!

STANDARD EQUIPMENT INCLUDES: Lifetime warranty for residential installations, Commercial installations 5 year warranty, Stainless steel tank, Readily accessible tank opening for inspection and clean out, smooth coil surface of stainless steel, 2" CFC-free insulation, Polypropylene outer jacket, Honeywell L4006A control with 2 degree differential.

| FIG. NO. | MODEL | DOMESTIC TANK CAPACITY (GALLONS) | First Hour Rating Gal/Hr) at: | | WEIGHT NET LBS | PRICE |
|----------|-------|----------------------------------|-------------------------------|-------|----------------|-------|
| | | | 140°F | 115°F | | |
| 49877 | MS-21 | 21 | 91 | 126 | 53 | |
| 49707 | MS-26 | 26 | 142 | 197 | 57 | |
| 49876 | MS-40 | 40 | 166 | 230 | 77 | |
| 50372 | MS-53 | 53 | 224 | 310 | 103 | |
| 76264 | MS-79 | 79 | 253 | 350 | 204 | |

NASSAU CAST IRON, OIL FIRED STEAM BOILER





STANDARD EQUIPMENT (WITH COIL) INCLUDES: Completely factory assembled, pre-wired and crtd, Flue collector, Deluxe baked enamel steel jacket, Oil burner with cad cell, oil solenoid valves, R-8184G, primary control mounted, Tankless heater, Glass gauge with trimmings, ASME 3/4" pop safety valve, Silicone sealant, Boiler drain, Draft regulator, PA-404A pressure trol, L-4006A Aquastat, Steam gauge, Low water cutoff #67 (float type)

STANDARD EQUIPMENT (LESS COIL) INCLUDES: Same as above except; cover plate for tankless heater, no tankless heater, No. L4006A Aquastat.

| MODEL NO. | NO. OF SPECS | DOE HEATING CAPACITY BTU/HR | IBR NET RATING BTU/HR | SQUARE FOOT RADIATION | BURNER CAPACITY GPH | TANKLESS HEATER GPM | APPROX SHIPPING WGHT Knockdown PKG | DOE ANNUAL EFFICIENCY (AFUE) | PRICE |
|-----------|--------------|-----------------------------|-----------------------|-----------------------|---------------------|---------------------|------------------------------------|------------------------------|-------|
| 41273 | 3 | 118,000 | 89,000 | 369 | 1.00 | 2.75 | 607 | 81.7 | |
| 41274 | 3 | 145,000 | 109,000 | 453 | 1.25 | 3.00 | 607 | 80.2 | |
| 41275 | 3 | 156,000 | 117,000 | 488 | 1.35 | 3.25 | 607 | 80.0 | |
| 41276 | 4 | 177,000 | 133,000 | 553 | 1.50 | 3.50 | 726 | 82.3 | |
| 41277 | 4 | 204,000 | 153,000 | 638 | 1.75 | 3.75 | 726 | 81.1 | |
| 41278 | 4 | 215,000 | 161,000 | 672 | 1.85 | 4.00 | 726 | 80.5 | |



BAHAMA CAST IRON OIL FIRED HOT WATER BOILER

STANDARD EQUIPMENT (WITH COIL) INCLUDES: Completely factory assembled, pre-wired and crtd, Deluxe baked enamel steel jacket, Oil burner with cad cell relay & nozzle, L8124C combination Aquastat relay, 1 1/4" circulator wired and piped to boiler, tankless coil, Combination temperature pressure gauge, Boiler drain, ASME relief valve, Draft regulator.  

STANDARD EQUIPMENT (LESS COIL) INCLUDES: Same as above except no tankless coil, L8148A in place of L8124C.

| MODEL NO. | NO. OF SPECS | DOE HEATING CAPACITY BTU/HR | IBR NET WATER RATING BTU/HR | BURNER CAPACITY GPH | TANKLESS HEATER GPM | APPROX SHIPPING WGHT | DOE ANNUAL EFFICIENCY (AFUE) | PRICE |
|-----------|--------------|-----------------------------|-----------------------------|---------------------|---------------------|----------------------|------------------------------|-------|
| 82386 | 3 | 74,000 | 64,000 | .60 | 2.00 | 507 | 86.1 | |
| 38708 | 3 | 92,000 | 80,000 | .75 | 2.50 | 507 | 85.6 | |
| 38709 | 3 | 120,000 | 104,000 | 1.00 | 3.00 | 507 | 84.4 | |
| 82387 | 4 | 111,000 | 97,000 | .90 | 2.75 | 597 | 86.4 | |
| 38710 | 4 | 153,000 | 133,000 | 1.25 | 3.25 | 597 | 85.9 | |
| 38711 | 4 | 181,000 | 157,000 | 1.50 | 3.50 | 597 | 85.1 | |
| 82388 | 5 | 147,000 | 128,000 | 1.20 | 3.15 | 693 | 86.1 | |
| 38712 | 5 | 210,000 | 183,000 | 1.75 | 4.00 | 693 | 84.8 | |
| 38713 | 5 | 239,000 | 209,000 | 2.00 | 4.50 | 693 | 84.0 | |

**DO YOU KNOW WHAT A BTU (British Thermal Unit) IS?
IT IS THE AMOUNT OF ENERGY NEEDED TO RAISE 1 LB OF WATER 1⁰F. IN ONE HOUR**

FREERPORT CAST IRON THREE PASS "SCOTCH MARINE" OIL FIRED HOT WATER BOILER

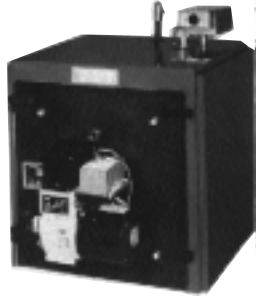

STANDARD EQUIPMENT INCLUDES: Completely factory assembled, Pre-wired and crated, Deluxe baked enamel steel jacket (shipped in separate carton), Refractory insulated hinged front door with sight glass, 7" draft regulator, ASME relief valve.



| MODEL/FIG. NO. | NO. OF SPECS | DOE BTU/HR | IBR NET WATER BTU/HR | BURNER CAPACITY GBH | SHIPPING WEIGHT | AFUE |
|----------------|--------------|------------|----------------------|---------------------|-----------------|------|
| 41285 | 3 | 92,000 | 80,000 | .75 | 433 | 86.1 |
| 80806 | 3 | 120,000 | 104,000 | 1.00 | 443 | 84.7 |
| 41286 | 4 | 121,000 | 105,000 | 1.00 | 527 | 86.1 |
| 74974 | 4 | 160,000 | 139,000 | 1.35 | 527 | 84.0 |
| 41287 | 5 | 162,000 | 141,000 | 1.35 | 618 | 86.1 |
| 42903 | 6 | 202,000 | 176,000 | 1.65 | 716 | 86.1 |
| 4904 | 7 | 243,000 | 211,000 | 2.00 | 794 | 86.1 |
| 42905 | 8 | 286,000 | 249,000 | 2.50 | 902 | 85.3 |

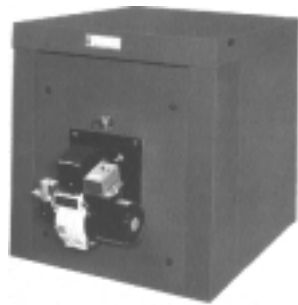

F SERIES CAST IRON 3 PASS "SCOTCH MARINE" COMMERCIAL OIL OR GAS HOT WATER BOILER

STANDARD EQUIPMENT INCLUDES: Boiler sections shipped, fully assembled, Refractory insulated hinged front door with sight glass, Deluxe baked enamel steel jacket with foil faced blanket insulation, Combination temperature - pressure gauge, ASME relief valve, High limit control (L4008A with remote capillary), Smoke outlet transmission piece/quad locking damper, Supply manifold (for mounting controls), Safety disconnect burner plug for front door.

| MODEL/FIG. NO. | I=B=R | | I=B=R *Gross Output Rating | | I=B=R | I=B=R | APPROX DRY WGHT LBS | PRICE |
|----------------|---------|---------|-------------------------------|------|----------------------|----------------------------|---------------------|-------|
| | OIL GPH | GAS MBH | MBH | BHP | NET RATING WATER MBH | BREECHING OR VENT (INCHES) | | |
| F-4 | 3.0 | 433 | 355 | 10.6 | 309 | 7 | 948 | |
| F-5 | 4.0 | 577 | 478 | 14.2 | 416 | 7 | 1124 | |
| F-6 | 5.0 | 722 | 600 | 17.9 | 522 | 8 | 1301 | |
| F-7 | 6.0 | 866 | 723 | 21.6 | 629 | 9 | 1477 | |
| F-8 | 7.5 | 1082 | 907 | 27.1 | 789 | 10 | 1654 | |
| F-9 | 9.0 | 1299 | 1091 | 32.6 | 949 | 10 | 1831 | |

WARM AIR FURNACES

AVAILABLE WITH CENTRAL AIR!



GAS FIRED
LP or Natural
45 to 185,000 BTU

OIL FIRED
84 to 150,000 BTU

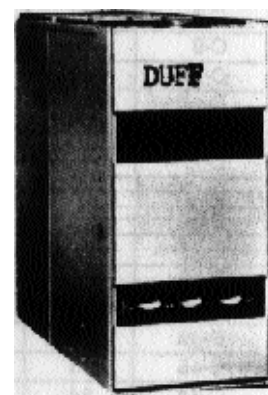

CALL FOR PRICING AND AVAILABILITY!

BOILERS

SCOTCH MARINE BOILERS

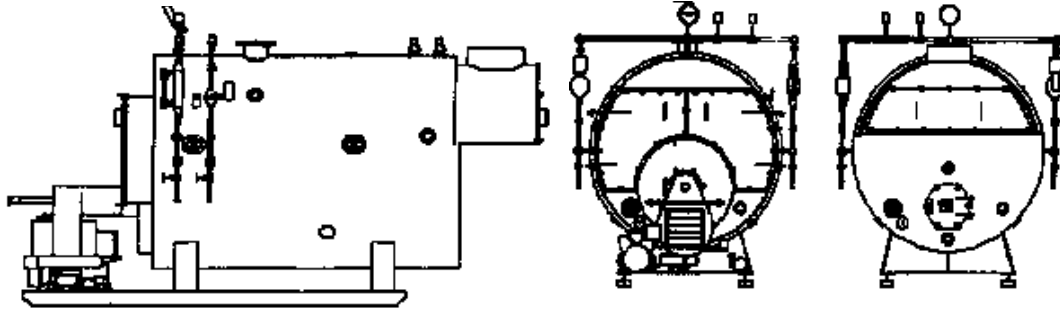

DID YOU KNOW?

THAT 1 BOILER HORSEPOWER IS EQUAL TO 33,479 BTU/HR OR 34.5 LBS OF STEAM PER HOUR!

BURNHAM - EASCO - CROWN - CLEAVER BROOKS
Call our heating department for sizing and quotation!

SMITH MILLS CAST IRON OIL OR GAS BOILERS

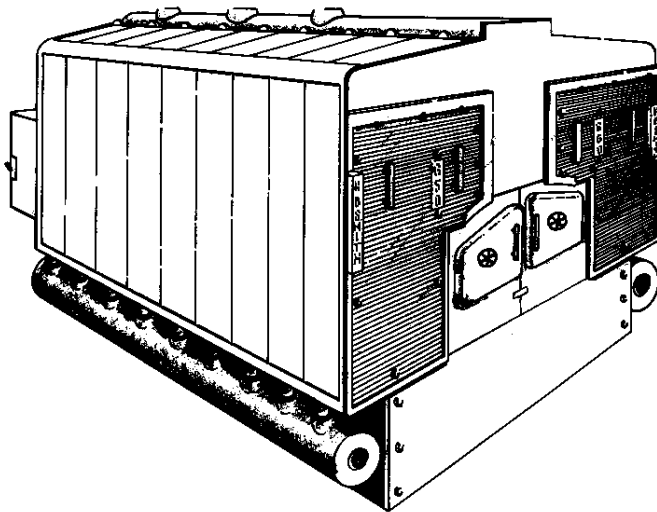

Call for parts and information!

SMITH MILLS CAST IRON BOILER PARTS

Call for pricing and availability!

610-275-4453

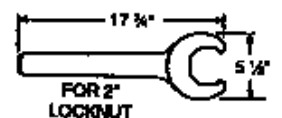
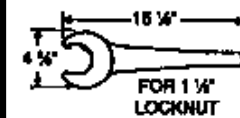
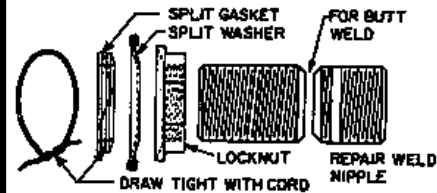
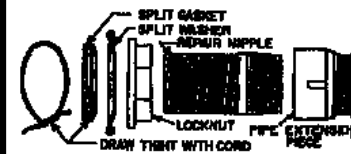
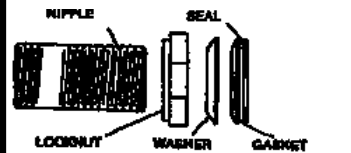

BOILER HANDHOLE AND MANHOLE GASKETS

All boiler gaskets are made of 1/4" EPDM rubber

ELLIPTICAL - "E"



| SIZE | FIG. NO. | PRICE |
|-------------|----------|-------|
| 11X15X1-1/4 | 16218 | |
| 12X16X1-1/4 | 16223 | |

OB ROUND "OB"



| SIZE | FIG. NO. | PRICE |
|-----------------|----------|-------|
| 3X4X1/2 | 16134 | |
| 4X6X3/4 | 16180 | |
| 4-1/2X3-1/2X1/2 | 52528 | |

EPDM has excellent resistance to steam and high temperature while other types of rubber may not.

HUNDREDS OF OTHER SIZES AND MANY SHAPES AVAILABLE!



For additional information call: 610-275-4453 or Fax: 610-279-6299
Please call for current prices.

GAS-FIRED INFRA-RED GARAGE/SHOP HEATER

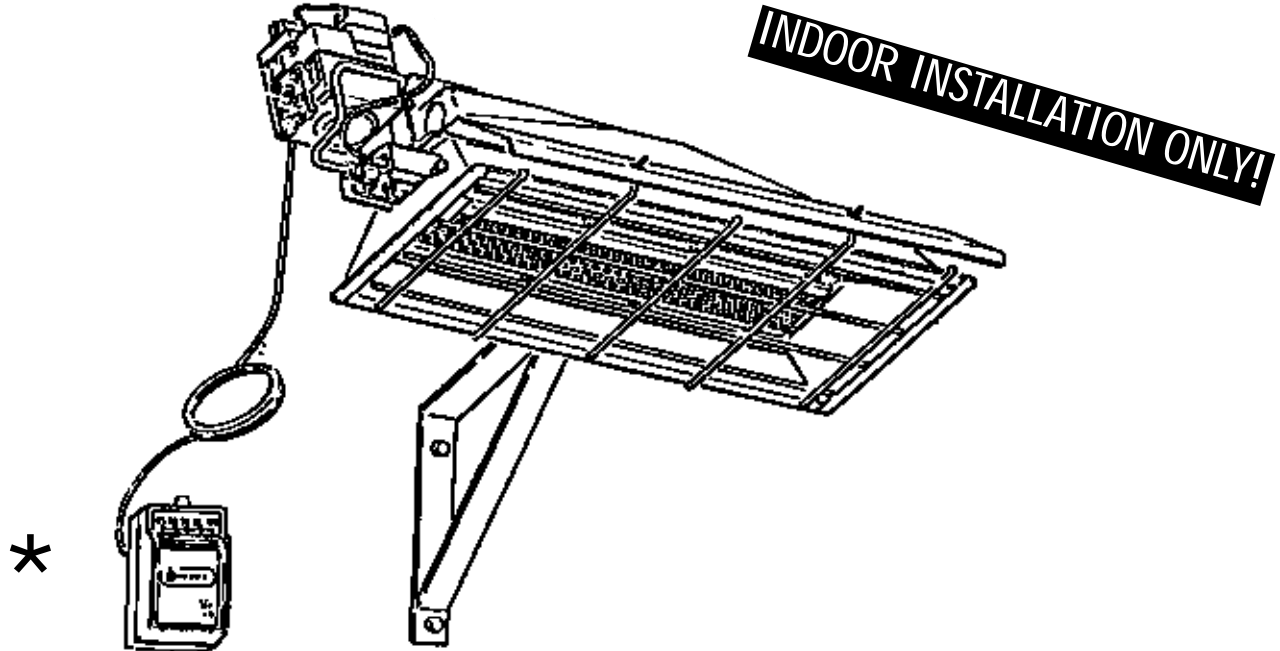

control systems available

| Suffix | Description | Gas |
|--------|---|-------------------|
| DSP5 | Automatic Spark Ignition on Pilot with Safety Burner Shutoff, 24V. AC Control with intermittent pilot. (Pilot is off when heater is off.) Transformer (120/25V.) is shipped loose with each heater. | Natural |
| A-5 | Automatic Spark Ignition on Pilot with Safety Shutoff on Pilot and Burner, 24V. AC Control with intermittent pilot. (Pilot is off when heater is off.) Transformer (120/25V.) is shipped loose with each heater. | Natural & Propane |
| PP | Power Pile (self-generating) Control. No outside electrical source required to turn heater on and off. Manually fill pilot. Safety Shutoff on Pilot and Burner. Power Pile Thermostat shipped loose with each heater. | Natural & Propane |

| FIG. NO. | DESCRIPTION | GAS | BTU/HR | PRICE |
|----------|-------------------|-----|--------------|-------|
| 39220 | Enerco 4040NDSP5 | N | 40 Thousand | |
| 39224 | Enerco 4040NPP | N | 40 Thousand | |
| 39226 | Enerco 40400LA5 | LP | 40 Thousand | |
| 39228 | Enerco 4040LPP | LP | 40 Thousand | |
| 39230 | Enerco 8060NDSP5 | N | 60 Thousand | |
| 39236 | Enerco 8060NPP | N | 60 Thousand | |
| 39239 | Enerco 8060LA5 | LP | 60 Thousand | |
| 39241 | Enerco 8060LPP | LP | 60 Thousand | |
| 39244 | Enerco 9100SNDSP5 | N | 100 Thousand | |
| 39249 | Enerco 9100SNPP | N | 100 Thousand | |
| 39353 | Enerco 9100SLA5 | LP | 100 Thousand | |
| 39256 | Enerco 9100SLPP | LP | 100 Thousand | |
| 39258 | Enerco 9120NDSP5 | N | 100 Thousand | |
| 39264 | Enerco 9120NPP | N | 120 Thousand | |
| 39269 | Enerco 9120LPP | LP | 120 Thousand | |

* Thermostat and bracket not included

STEAM/HOT WATER UNIT HEATERS

MODINE STEAM HEATER Faster installation, rugged construction. Finished grey-green raked enamel with rust protection finish.

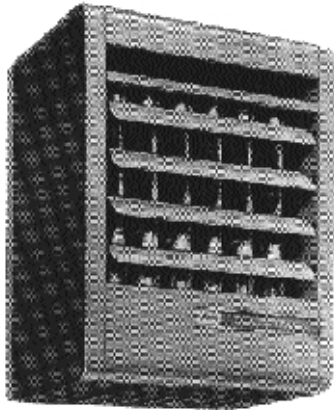

ALSO AVAILABLE IN GAS FIRED! CALL FOR MORE INFORMATION

| DESCRIPTION | FIG. NO. | BTU PER HOUR | PRICE |
|-------------|----------|--------------|-------|
| Horizontal | 41510 | 18,000 | |
| Horizontal | 41511 | 24,000 | |
| Horizontal | 41512 | 33,000 | |
| Horizontal | 41513 | 47,000 | |
| Horizontal | 41514 | 63,000 | |
| Horizontal | 41515 | 86,000 | |
| Horizontal | 41516 | 108,000 | |
| Horizontal | 41517 | 121,000 | |
| Horizontal | 41518 | 165,000 | |
| Horizontal | 41519 | 193,000 | |
| Horizontal | 41520 | 258,000 | |
| Horizontal | 41521 | 290,000 | |
| Horizontal | 41522 | 340,000 | |
| Vertical | 41532 | 279,000 | |



VENTLESS Gas Space Heater

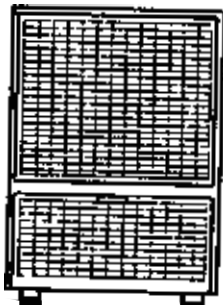

Easily installed with optional floor stand (as shown) or can be wall mounted with just three screws! Integral piece ignition. Adjustable 7,700 BTU, 13,500 BTU and 19m,000 BTU Oxygen depletion sensor device cuts unit off. **CALL FOR OTHER SIZES!**

HIDE-A-VECTOR

Two compact models for horizontal or vertical installation

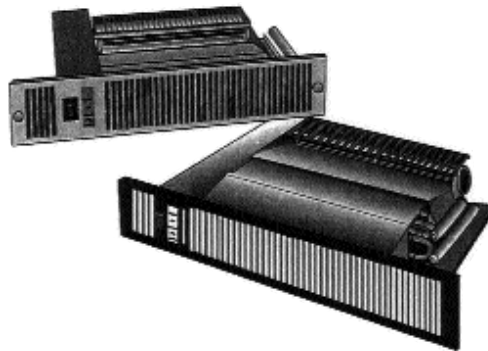

| MODEL | FIG. NO. | PRICE |
|--------|----------|-------|
| HAV-48 | 44574 | |
| HAV-88 | 44575 | |

HAV-48

Air flow - 36 CFM effective range 10-15 ft. 115/120v/. 1 ph., 60 cy. 3/10 amp., 20 watts.

| | GPM | LB/HR | 160°F | 170°F | 180°F | 190°F | 200°F | 210°F |
|-----------------|-----|-------|-------|-------|-------|-------|-------|-------|
| 14" x18" | 5 | 2500 | 3510 | 3900 | 4280 | 4660 | 5010 | 5400 |
| | 1 | 500 | 3400 | 3760 | 4100 | 4370 | 4700 | 5060 |

HAV-88

Air flow - 72 CFM effective range 10-15 ft. 115/120v/. 1 ph., 60 cy. 1/2 amp., 20

| | GPM | LB/HR | 160°F | 170°F | 180°F | 190°F | 200°F | 210°F |
|-----------------|-----|-------|-------|-------|-------|-------|-------|-------|
| 21" X18" | 5 | 2500 | 7180 | 7950 | 8670 | 9420 | 10170 | 10900 |
| | 1 | 500 | 6730 | 7430 | 8130 | 8830 | 9530 | 10230 |

CAST IRON BASEBOARD

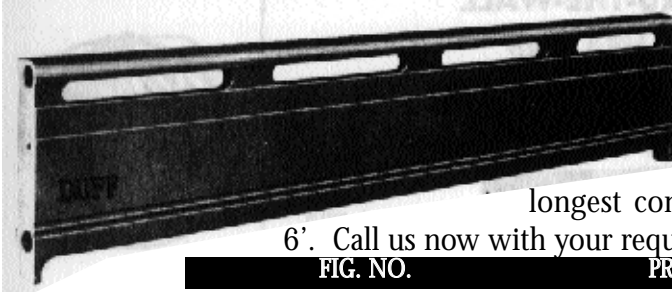

**CAST IRON HI
BASEBOARD. 9**
7/8" high, 3.4
Sq. Ft./Lin. Ft.
Sold per foot,

longest continuous length =
6'. Call us now with your requirements!

| FIG. NO. | PRICE PER FOOT |
|----------|----------------|
| 15192 | |



Center Leg

| FIG. NO. | PRICE |
|----------|-------|
| 15198 | |



Holding Lug

| FIG. NO. | PRICE |
|----------|-------|
| 15197 | |

ALSO AVAILABLE!

| Push Nipple | Tie Bolt & Nut | Assembly Tool |
|-------------|----------------|---------------|
| 15199 | 15201 | 41967 |



Left Hand Valve
Enclosure 5"

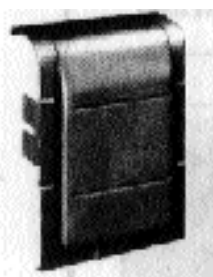

Right Hand Valve
Enclosure 5"

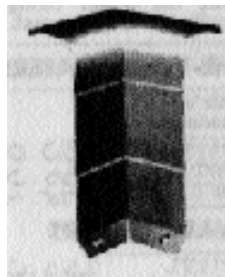

4 4/8" Inside
Corner

| FIG. NO. | PRICE | FIG. NO. | PRICE | FIG. NO. | PRICE |
|----------|-------|----------|-------|----------|-------|
| 15194 | | 15193 | | 15195 | |

FIN TUBE BASEBOARD

EMBASSY fin tube baseboard heat. 3/4" copper fin tube. 8' lengths only.

How to order:

COMPLETE PACKAGE: Includes assembled baseboard, damper vane, heating element with expansion cradles and 2" splice plate set.

COVER ASSEMBLY: Includes everything in complete package EXCEPT element or expansion cradles.

HEATING ELEMENT: Includes heating element only - NO enclosure.

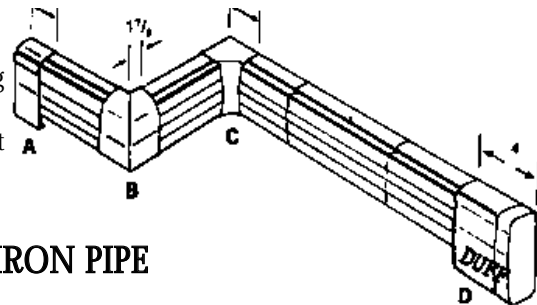

AVAILABLE: 1 1/4" COPPER AND 1 1/4" IRON PIPE

| | 2 | | 3 | | 4 | | 5 | | 6 | | 7 | | 8 | | 10 | |
|-----------|---------|-------|---------|-------|---------|-------|---------|-------|---------|-------|---------|-------|---------|-------|---------|-------|
| DESCR | FIG NO. | PRICE | FIG NO. | PRICE | FIG NO. | PRICE | FIG NO. | PRICE | FIG NO. | PRICE | FIG NO. | PRICE | FIG NO. | PRICE | FIG NO. | PRICE |
| Complete | 43251 | | 9092 | | 9094 | | 9102 | | 9104 | | 9107 | | 9110 | | 9112 | |
| Cover Ass | 43252 | | 9114 | | 9116 | | 9118 | | 9119 | | 9370 | | 9421 | | 9422 | |
| Element | 43253 | | 9423 | | 9424 | | 9425 | | 9426 | | 9427 | | 9428 | | 9429 | |

| DESCRIPTION | FIG. NO. | PRICE |
|----------------------|----------|-------|
| 3 RH end cap | 9430 | |
| 3 LH end cap | 9431 | |
| Hinged RH end cap | 9432 | |
| Hinged LH end cap | 9433 | |
| Inside 90 corner | 9434 | |
| Inside 45/135 corner | 9435 | |
| Outside corner | 9436 | |

| DESCRIPTION | FIG. NO. | PRICE |
|---------------------|----------|-------|
| 3" wall trim | 49370 | |
| 5" wall trim | 9438 | |
| Damper joiner | 9439 | |
| Return tube support | 9440 | |
| Splicer set | 9441 | |
| Hanger bracket | 9442 | |
| Copper return bend | 9443 | |

Duff custom radiator covers are available in three standard grill styles and 7 colors! Also available custom convector covers custom baseboard covers custom air conditioner covers and custom grilles!

CALL FOR
SIZING INFO

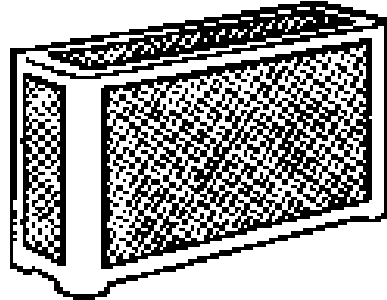

FREE STANDING RADIATORS



**MANY SIZES
AVAILABLE!**
Call our
heating
department
for sizing
and prices.

CALL DUFF FOR PRICING AND AVAILABILITY!!

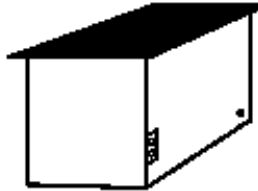

◀ Whisper II 5000 recessed Floor Fan Convector delivers up to 7,136 BTU/hr from a space just a little more than 14 3/8" x 8 1/4" x 9 3/8".



◀ Whisper II 9080 & 9080 Wall Mount Fan Convectors fit in an area less than 20" x 20" delivering the same quality output of the Whisper II MYSON Kickspace Heaters.

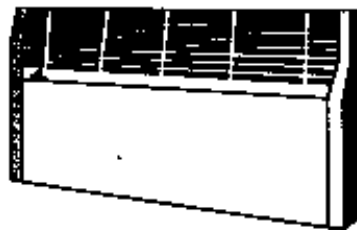

◀ Lo-Line Fan Convectors... 4 models range from 2,000 to 20,000 BTU/hr replace 32 feet of baseboard.



◀ Slim-Line Fan Convector Measuring less than 16" wide, and with an output as high as 13,000 BTU/hr, Slim-Line fits neatly into narrow alcoves.

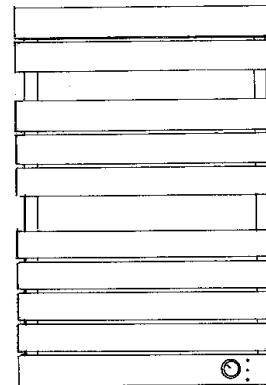

**THE RUNTAL
OMNIPANEL** Towel Warmer Radiators. Available in hydronic, direct wire and plug in GFCI plug. Many sizes and options. Robe knobs, towel bars, pull out drying racks, Coat racks also available!

**CALL NOW FOR
PRICING AND
AVAILABILITY!**

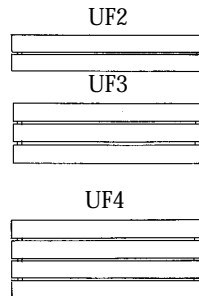

2"

**RUNTAL EURO
BASEBOARD**

Available 2' thru 14'.
*Easy to buy
*Easy to install
*Hot water
*Standard color white
*Customer colors available

RADIANT FLOOR HEATING

Pextron tubing is suitable for installation in almost any flooring type. The installation techniques vary according to the application. Example of type are shown below. Detailed advise and pricing for most types of construction are available upon request.

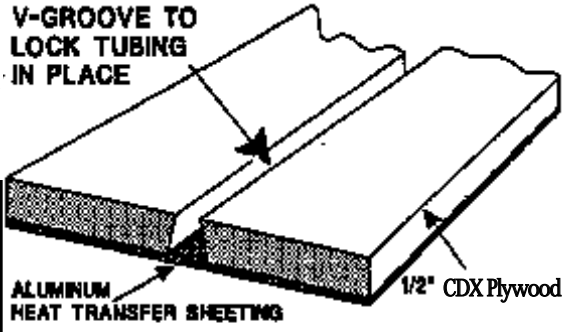

Climate Panel

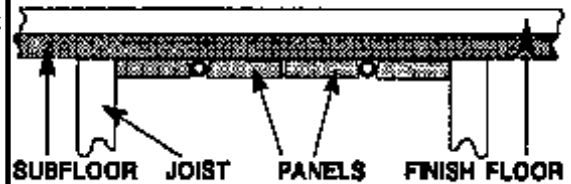

Beneath Subfloor

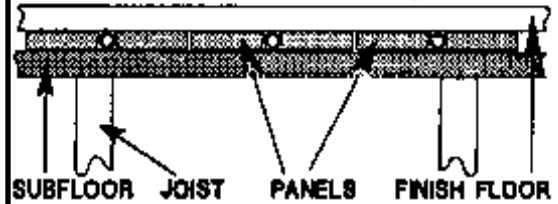

Above Subfloor or Concrete Slab

SNOWMELT

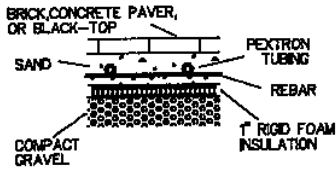

SLAB ON GRADE

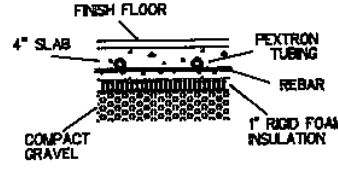

BELOW SUBFLOOR

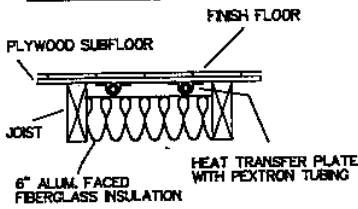

CONCRETE ON SUBFLOOR

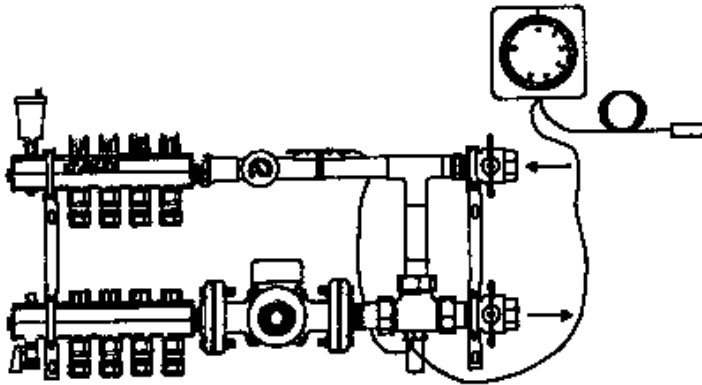
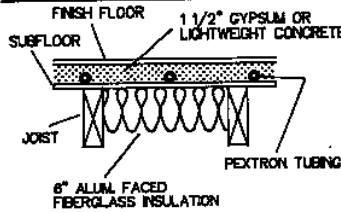

STADLER Climate Panel Radiant Underlayment System is the preferred choice for walls and floors in most wood construction

Radiant Floor Heating (below subfloor)

Stadler radiant underlayment module 1/2" X 7" X 48"
Pextron 3/8" tubing

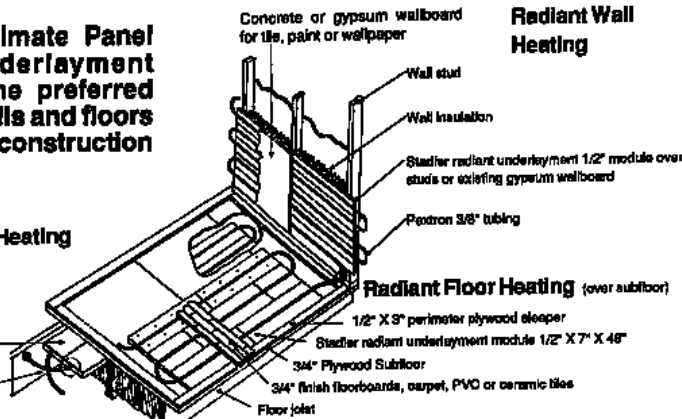

Radiant Wall Heating

Radiant Floor Heating (over subfloor)

1/2" X 3" perimeter plywood sleeper
Stadler radiant underlayment module 1/2" X 7" X 48"
3/4" Plywood Subfloor
3/4" finish floorboards, carpet, PVC or ceramic tiles
Floor joist

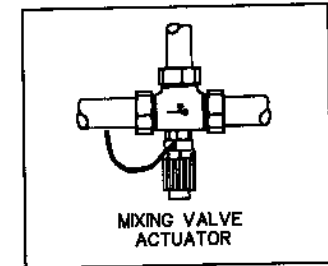
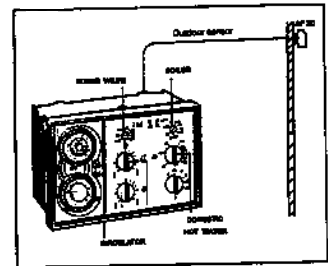

MIXING VALVE ACTUATOR

HONEYWELL CONTROLS

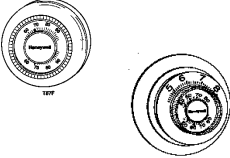
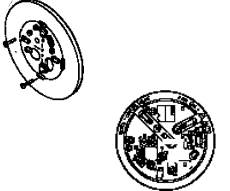
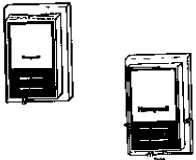
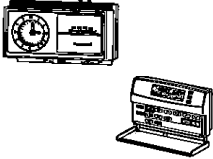
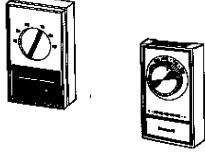
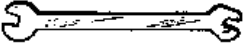
| FIG. NO. | DESCRIPTION | PRICE | |
|--|--|-------|---|
| 10263 10256 44792 | T87F2873 "The Round" 40-90 °F T87F1859 Includes 6" wall plate T87F3467 Easy-To-See Enlarged scale and raised designations | |  |
| 10257 9710 9945 9721 | T87F2782 Head only 35-65°F scale Q539A1014 Heating cooling subbase Q539A1147 or independent cool circuits Q539C1020 Cooling only | |  |
| 10250 50586 | T822D1024 Rectangular heating T834C1137 Rectangular heating & cooling | |  |
| <u>CLOCK THERMOSTAT</u> | | | |
| 10234 48427 39058 | T8090A1007 Low voltage set back thermostat T8600A1000 Microelectronic set back heat only T8600C1014 Microelectronic set back heat & cool | |  |
| <u>LINE VOLTAGE THERMOSTATS</u> | | | |
| 34438 10228 44793 | T498B1512 Electric heat thermostat T451A2007 35-95 Spst. 120/208/240/277 volt T651A2028 35-95 Spdt 120/208/240/277 volt | |  |
| <u>CALIBRATION WRENCH</u> | | | |
| 44794 | Used on all low voltage thermostats | |  |

IF YOU DON'T SEE IT...PLEASE CALL! WE HAVE MUCH MORE IN STOCK! MOST HONEYWELL CONTROLS OR VALVES CAN BE HAD OVERNIGHT - DIRECT TO YOU!

FAN RELAYS HONEYWELL

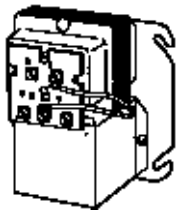

FAN CENTERS

Used for low voltage control of line voltage fan motors in heating and cooling equipment. Enclosed relay with 38 VA transformer. Mounts on 4x4" electrical box. Contact: 1 normally open, 1 normally closed.

SPDT switching for single or 2-speed fan operation. electrical rating: 13.8 amps @ 120v, 6.9 amps @ 240v.

DPDT switching to control fan with electronic air cleaner or humidifier.

| Fig. No. | Mfg. No. | Primary Voltage | Secondary Voltage | Switch Action | Price |
|----------|------------|-----------------|-------------------|---------------|-------|
| 10063 | R8239A1052 | 120 | 27 | SPDT | |

DPDT switching to control fan with electronic air cleaner or humidifier.

| Fig. No. | Mfg. No. | Primary Voltage | Secondary Voltage | Switch Action | Price |
|----------|------------|-----------------|-------------------|---------------|-------|
| 10181 | R8239B1043 | 120 | 27 | DPDT | |

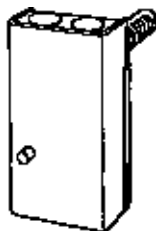

FAN AND LIMIT CONTROLS
Provides fan operation control and high limit protection on all types of forced air heating systems. Used in line voltage, low voltage or powerpile applications.

Standard replacement type. Helical bimetal sensing element; manual/automatic fan switch, metal cover.

LIMIT RANGE: 100 to 250°

LIMIT DIFFERENTIAL: 25°

FAN ON SETTING RANGE: 65 to 215°

FAN OFF SETTING RANGE: 50 to 200°

FAN ADJUSTABLE DIFFERENTIAL: 22° min.

| Fig. No. | Mfg. No. | Element Insertion | Mounting | Price |
|----------|------------|-------------------|---------------|-------|
| 9517 | L4064B1469 | 5" | Rigid Bracket | |
| 9534 | L4064B2236 | 8" | Surface | |
| 9513 | L406B1451 | 11-1/2" | Rigid Bracket | |

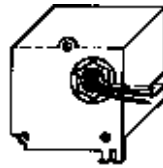

FAN RELAY

For 24 volt circuit control of line voltage fan motors and auxiliary circuits in heating, cooling and heat/cool systems. Has 1 normally open contact; one normally-closed contact; built-in spud for junction box mounting.

ELECTRICAL RATING: N.O. contacts - 14 amps @ 120v, 8 amps @ 240v. N.C. contacts - 14 amps @ 120v, 7 amps @ 240v.

| Fig. No. | Mfg. No. | Coil Voltage | Switching Action | Price |
|----------|------------|--------------|------------------|-------|
| 10059 | R8225A1017 | 24 | SPDT | |

SWITCHING RELAY

These relays provide intermediate switching to allow a low-voltage controller to control a line-voltage device. Built-in transformers supply the low-voltage current for the thermostat circuit.

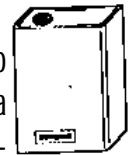

9976-Low voltage control of one line voltage load. Electrical rating: 10.2 amps @ 120 v, 5.1 amps @ 240 v.

9740 - Low voltage control of two line voltage loads having a common power source Electrical rating: 87.4 amps @ 120v, 3.7 amps @ 240v.

| Fig. No. | Mfg. No. | Supply Voltage | Control Circuit | Switch Action | Price |
|----------|------------|----------------|-----------------|---------------|-------|
| 9976 | RA89A1074 | 120 | 24V,2wire | SPST | |
| 9740 | RA832A1066 | 120 | 24V,2wire | DPST | |

SWITCHING RELAY

Provides DPST switching for hydronic zone-control systems or SPST switching of two separate loads. One load must be line voltage, the second load may be either line or low voltage.

ELECTRICAL RATING: 7.4 amps @ 120v, 3.7 amps @ 240v.



| Fig. No. | Mfg. No. | Supply Voltage | Control Circuit | Switch Action | Price |
|----------|-----------|----------------|-----------------|---------------|-------|
| 10195 | R845A1030 | 24 | SPDT | | |

TACO AND ARGO HYDRONIC CONTROLS

SWITCHING RELAYS

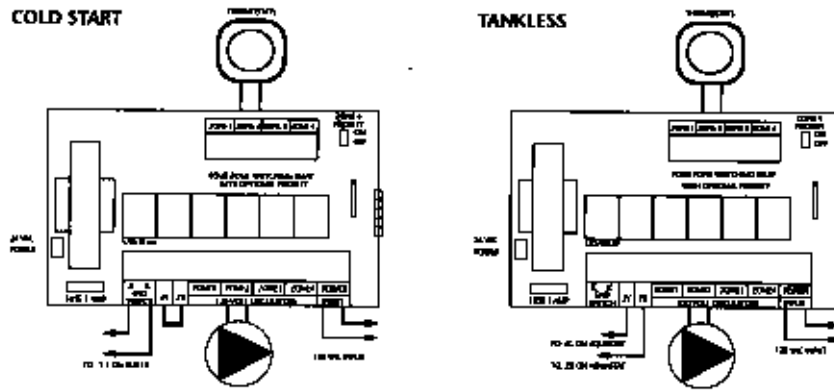

| FIG. NO. | # OF ZONES | MAX OUTPUT AT 24 VAC | TRANSFORMER VOLTAGE | DIMENSIONS OF ENCLOSURE | | |
|----------|-----------------|----------------------|---------------------|-------------------------|--------|--------|
| | | | | WIDTH | HEIGHT | DEPTH |
| 72754 | 1 zone | 7.2 amps | 120 VAC input | 4 1/4" | 5 1/4" | 2 3/4" |
| 72747 | 2 with priority | 15 amps | 20 VAC input | 10 1/4" | 6 3/4" | 2 3/4" |
| 82487 | 3 with priority | 15 amps | 20 VAC input | 10 1/4" | 6 3/4" | 2 3/4" |
| 72748 | 4 with priority | 20 amps | 20 VAC input | 10 1/4" | 6 3/4" | 2 3/4" |
| 75957 | 6 with priority | 20 amps | 20 VAC input | 11 3/4" | 7 1/2" | 3" |

ZONE VALVE CONTROLS

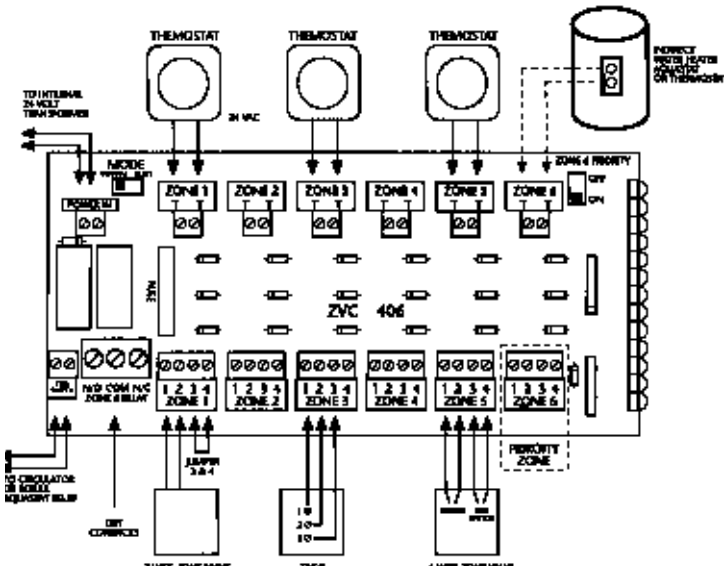

| FIG. NO. | # OF ZONES | MAX OUTPUT AT 24 VAC | TRANSFORMER VOLTAGE | DIMENSIONS OF ENCLOSURE | | |
|----------|-----------------|----------------------|---------------------|-------------------------|--------|--------|
| | | | | WIDTH | HEIGHT | DEPTH |
| 72750 | 3 zone | 40 VA | 120VACinput | 10 1/4" | 6 3/4" | 2 3/4" |
| 72749 | 4 with priority | 40 VA | 120VACinput | 10 1/4" | 6 3/4" | 2 3/4" |
| 72751 | 5 zone | 75 VA | 120VACinput | 10 1/4" | 6 3/4" | 2 3/4" |
| 82488 | 6 with priority | 75 VA | 120VACinput | 11 3/4" | 7 1/2" | 3" |

For additional information call: 610-275-4453 or Fax: 610-279-6299
Please call for current prices.

ZONE VALVE CONTROLLERS

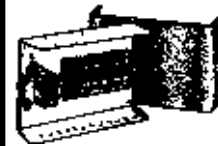

Makes a fast, simple job of wiring multiple 3 or 4 wire 24 volt zone valves. Solid state controls includes transformer, internal isolated end switch and terminal board wiring for thermostats and zone valves. Operates Honeywell, Taco and most other popular zone valves.

| FIG. NO. | MFG. NO. | # OF ZONES | TRANSFORMER | PRICE |
|----------|----------|------------|-------------|-------|
| 49329 | AZV-243 | 3 | 40 VA | |
| 44644 | AZV-245 | 5 | 75 VA | |

MULTI-ZONE CIRCULATOR SWITCHING RELAYS



Intermediate switching for up to six circulators. For large zoning jobs such as apartment buildings and other commercial applications.

The AR series relays are controlled by 24 volt thermostats or other 24 volt controllers, and will handle motor loads up to 1/3 HP @ 120v AC. Can be used with either cold-start or tankless heater boiler applications.

| FIG. NO. | MFG. NO. | # OF ZONES | TRANSFORMER | PRICE |
|----------|----------|------------|-------------|-------|
| 49328 | AR861-2 | 2 | 15VA | |
| 44645 | AR861-3 | 3 | 15VA | |
| 45166 | AR842 | 4 | 15VA | |
| 44646 | AR866 | 6 | 15VA | |

GENERAL PURPOSE SWITCHING RELAYS



For controlling line voltage loads with a low voltage circuit in applications such as circulators, fan motors and pumps up to 1/3 HP @ 120v AC. Full 10 amp load rating, replaceable plug-in relay, 15 VA transformer, quick connect wiring terminals.

| FIG. NO. | MFG. NO. | ACTION | TRANSFORMER | PRICE |
|----------|----------|--------|-------------|-------|
| 47699 | AR821 | DPST | 15VA | |
| 53055 | AR822 | DPDT | 15VA | |

AQUASTAT REMOTE BULB CONTROLLERS

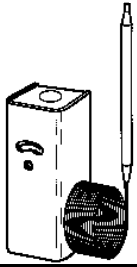

For limiting or regulating temperature of liquids in boilers or tanks. Can also sense duct or outside air temperature.

- * Remote temperature sensing element detects and responds rapidly to temperature changes.
- * Totally enclosed Micro Switch snap-acting switch
- * Visible control point scale and external adjustment screw permit easy setting.
- * Horizontal or vertical mounting of the remote element into boiler, tank or other container. Case mounts to vertical surface.

| FIG. NO. | DESCRIPTION | PRICE |
|----------|-------------|-------|
| 28075 | L4008A1015 | |

HONEYWELL AQUASTATS

| FIG. NO. | DESCRIPTION | PRICE |
|----------|---|-------|
| 50648 | L4006A1678 Contacts break on temp rise 100-240 | |
| 50649 | L4006B1155 Contacts make on temp rise 100-240 | |
| 9583 | L6006A1145 Single pole double throw 100-240 | |
| 9657 | L6006C1018 Spdt. strap on mounting 65-200 | |
| 55564 | L4006E1067 Manual reset high limit 130-270 | |
| 9664 | L8124A1007 Triple aquastat relay 120 volt burner control | |
| 9694 | L8148A1017 Aquastat relay 120 volt burner control | |
| 9698 | L8148J1009 Aquastat relay 24 volt or millivolt burner control | |

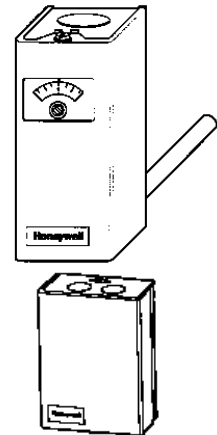

IMMERSION WELLS FOR TEMPERATURE CONTROL

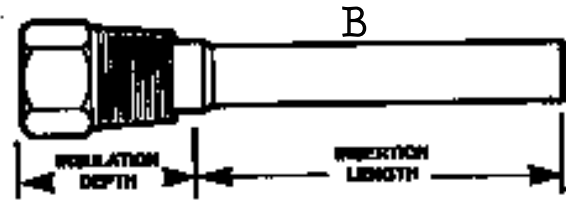
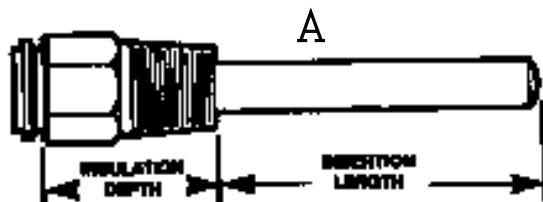

| FIG. NO. | DESCRIPTION | MFG # | NPT SIZE | SPUD INSUL DEPTH | INSERT LENGTH | BULB DIA | BULB LNTH | PRICE |
|----------|--|----------|----------|------------------|---------------|----------|-----------|-------|
| 10326 | L4006, L4007, L4008, L4062, L4043, L6006, L6008, L6018 | 121371A | A | 1/2 | 1 1/2 | 3 3/8 | 3/8 | 3 |
| 10328 | Same as 121371A | 121371B | A | 3/4 | 1 1/2 | 3 3/8 | 3/8 | 3 |
| 10335 | L6021, L6062, L8024, L8048, L8049, L8051, L8052, R4166 | 121371L | A | 1/2 | 3 | 3 3/8 | 3/8 | 3 |
| 10337 | Same as 121371M | 121371M | A | 3/4 | 3 | 3 3/8 | 3/8 | 3 |
| 40711 | L456, T414, T415, T614, T675, T678, T991 | 112622AA | B | 1/2 | 1 | 1/2 | 1/2 | 4 |
| 18238 | Same as 112622AA | 112630AA | B | 3/4 | 1 | 1/2 | 1/2 | 4 |
| 34755 | Heat conductive compound | 107408 | - | - | - | - | - | - |

ALSO AVAILABLE IN STAINLESS STEEL! CALL FOR PRICING AND AVAILABILITY!

HONEYWELL

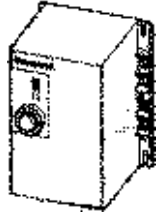

OIL BURNER PROTECTOR RELAY

Provides automatic, nonrecycling control of intermittent ignition oil burner systems. Used in conjunction with Fig. No.'s 9486 or 1058 and a 24v thermostat to switch line voltage to burner motor and ignition transformer. External push button reset after safety shutdown. Includes solid state flame sensing circuit and 24v transformer to power heating control circuit; mounts on standard 4x4" junction box. Electrical ratings; 45 second models - 7.4 amps @ 120v; 15 & 30 second models - 10.0 amps @ 120 v.

| Fig. No. | Mfg. No. | Safety Timing | Thermostat Circuit | Price |
|----------|------------|---------------|--------------------|-------|
| 10041 | R8184G4009 | 45 seconds | 24v | |
| 10042 | R8184G4066 | 15 seconds | 24v | |
| 10044 | R8184G4074 | 30 seconds | 24v | |



SOLENOID SAFETY (DELAYED OIL) VALVES

Designed to prevent noisy and smoky oil burner startup and shutdown, and minimize service problems caused by clogged nozzles and sooted firing components. Provides instantaneous shutoff of fuel flow when the thermostat breaks the burner circuit. Provides 5 to 9 second delay at startup to allow burner fan to reach full operating speed and pump to attain full pressure, assuring complete atomization and adequate combustion air volume. Designed for use with #2 and lighter fuel oil. Oil flow capacity: 35 pgh; maximum pressure; 300 psi.

| Fig. No. | Mfg. No. | Size | Delay | Voltage | Price |
|----------|------------|----------|----------|---------|-------|
| 10305 | V4046A1074 | 1/8" FPT | 5-9 sec. | 120 | |

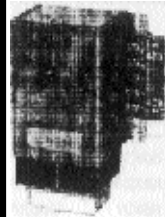

OIL BURNER PROTECTOR RELAY

For built-in-transformer for cooling controls. Same functions and specifications as standard models, but includes integral 40VA, 24 volt transformer to provide power for a low voltage cooling control system. "Y" and "G" terminals for compressor and fan relay operation.

| Fig. No. | Mfg. No. | Safety Timing | Thermostat Circuit | Price |
|----------|------------|---------------|--------------------|-------|
| 66926 | R8184M1051 | 45 seconds | 24v | |



CAD CELL FLAME DETECTOR

Light sensitive cadmium sulfide cell device. Will cause the primary control to shut down the oil burner upon flame failure.

Mounts on burner blast tube or ignition transformer plate. Use with 10041, 10042, 10044 or 66926.

| Fig. No. | Mfg. No. | Description | Price |
|----------|-----------|---|-------|
| 9486 | C554A1463 | Bulb&holder Ass'y w/ 60" leads, 3 mtg. brackets, oil line adapter | |
| 10358 | 120320 | Replacement cad cell bulb | |

If the burner is properly adjusted, cad cell resistance will be in the range of 300 to 1000 ohms when the burner is operating. To ensure continued reliable burner operation, the resistance of the cell should never be above 1600 ohms during the burner run cycle. If cell resistance is greater than 1600 ohms, the cad cell may need cleaning or adjusting, or the burner flame may need to be adjusted.

COMBINATION CONTROLS

Combination Protector Relay and Hydronic Heating Controller



Immersion type aquastat controller for oil-fired hydronic heating systems with intermittent ignition. Used in combination with a 9486 cad cell flame detector and 24 volt thermostat; provides high limit and low limit/circulator control.

71137/72262 - Direct mount onto 3/4" NPT well, including 1-1/2" jacket insulation thickness. Use for zone valve control or utilize "ZC"/"ZR" terminals for circulator control. Includes well adapter and heat conductive compound.

68867 - Mounts to 4x4" junction box, with remote sensing bulb on 5' armored capillary. Use of zone valve control or utilize "ZC"/"ZR" terminals for circulator zone control. Includes well adapter and heat conductive compound. Electrical rating: 4.4 amps @ 120v.



| FIG. NO. | MFG. NO. | SWITCHING | | ADJUSTABLE RANGE | | DIFFERENTIAL | | MOUNTING | PRICE |
|----------|-------------|------------|-----------|-------------------------|-------------------------|-----------------------|---------------------------|------------------|-------|
| | | HIGH LIMIT | LOW LIMIT | HIGH LIMIT | LOW LIMIT | HIGH LIMIT | LOW LIMIT | | |
| 71137 | R8182D1111 | SPST | SPDT | 130 to 240 ⁰ | 110 to 220 ⁰ | 10 ⁰ fixed | 10 to 25 ⁰ adj | direct, horiz | |
| 72262 | R8182D1079 | SPST | SPDT | 130 to 240 ⁰ | 110 to 220 ⁰ | 10 ⁰ fixed | 10 to 25 ⁰ adj | direct, vertical | |
| 68867 | R8182H10170 | SPST | SPDT | 130 to 240 ⁰ | 110 to 220 ⁰ | 10 ⁰ fixed | 10 to 25 ⁰ adj | 4x4" j-hook | |

For additional information call: 610-275-4453 or Fax: 610-279-6299
Please call for current prices.



GOLDLINE

UNIVERSAL TEMPERATURE CONTROL

Single stage electronic temperature control designed to be a direct replacement for outdated and unreliable electromechanical controls. Provides on/off temperature control with single-pole, double-throw relay output. Controlling temperature is the most important part of any HVAC/R system and it provides tight temperature control of +/-10F from the setpoint

temperature. This control can be mounted up to 1000' from the sensor which allows the installer to position the control in a more accessible and secure area. Take the error out of temperature controlling and give yourself the accuracy you deserve!

APPLICATIONS INCLUDE

- Walk-in coolers and freezers
- Greenhouses
- Radiant floor heating systems
- Aquariums
- Domestic hot water
- Refrigerated and frozen display cases
- environmental rooms

| Fig. No. | Setpoint Range | Switch Action | Differential | Price |
|----------|----------------|---------------|--------------|-------|
|----------|----------------|---------------|--------------|-------|

| | | | | |
|-------|---------------------------------------|------|---------------------|--|
| 50859 | -26 ^o to 90 ^o F | SPDT | 1-25 ^o F | |
| 76105 | 40 ^o to 104 ^o F | SPDT | 1-15 ^o F | |

SENSOR HOUSING

| Fig. No. | Price |
|----------|-------|
| 50860 | |

SENSORS

| Fig. No. | Price |
|-----------------------------|-------|
| Bolt type for flat surfaces | 65414 |

FOR WELLS, PLEASE SEE HONEYWELL SECTION

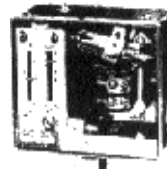

HONEYWELL PRESSURE CONTROLS L604A1169

Used as an operating control or automatic limit for pressure systems such as steam, air, non-combustible gases or non-corrosive fluids. SPDT mercury switch; stainless steel sensing element Connection is 1/4" FPT with syphon loop furnished. Replaces L404A, -B models range 2-15 psig - other ranges available.

| Fig. No. | Price |
|----------|-------|
| 76837 | |



ALSO AVAILABLE!

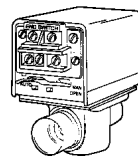

HONEYWELL ZONE VALVES

| DESCRIPTION | Fig. No. | Price |
|---------------------------------------|----------|-------|
| V8043F 1028 1/2" motorized zone valve | 10317 | |
| V8043F 1036 3/4" motorized zone valve | 10318 | |
| V8043F 1051 1" motorized zone valve | 10320 | |

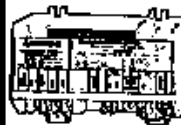

PILOT MODULE

Universal intermittent pilot module. S86A00A003 Replaces Honeywell S86, S90, S8600, S8610, Robert Shaw SP715, SP715A, SP735, SP735A, SP735L, Johnson GSA, G60, G65, G67, G600, G770 Gas valves, continuous pilot or intermittent pilot 1/2, 3/4 1" and up. LP gas or natural gas...too many to list!

| Fig. No. | Price |
|----------|-------|
| 50218 | |

FULL COST COMPARISON

| ELECTRICITY | FUEL OIL | NATURAL GAS | LP GAS |
|----------------------------|-----------------------------|-------------------------------|-----------------------------|
| A) _____ \$ per KWH | _____ \$ per gallon | _____ \$ per Therm | _____ \$ per Gallon |
| B) x 293 KWH/1,000,000 BTU | B) x 7.21 gal/1,000,000 BTU | B) x 10.0 Therm/1,000,000 BTU | B) x 11.0 Gal/1,000,000 BTU |
| C) _____ | C) _____ | C) _____ | C) _____ |
| D) Divided by Efficiency* | D) Divided by Efficiency* | D) Divided by Efficiency* | D) Divided by Efficiency* |
| E) _____ \$/1,000,000 BTU | E) _____ \$1,000,000 BTU | E) _____ \$/1,000,000 BTU | E) _____ \$/1,000,000 BTU |

*Use 1.6 as an efficiency for heat pumps Use .95 as an efficiency for all other electric heat systems. Fuel oil, gas - use annual efficiency rating of your application.

HONEYWELL GAS VALVES

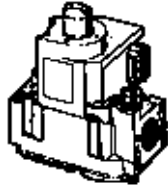

VR8304

DUAL VALVE COMBINATION GAS CONTROL for electronic intermittent pilot ignition systems. Used with S86F, -H; S8600F, -H; S8610 and S90A, -B ignition modules.

Replaces Honeywell VR8440, -8402;

White-Rodgers 36E36, -38; Robertshaw 7100DER.

Solenoid operated valve operates on an off with thermostat call, diaphragm operated valve opens under regulator control, closes if gas or power supply is interrupted.

MFG. NO.: VR8304M4507

SIZE IPT (inletxoutlet): 3/4 x 3/4"

BTUH CAPACITY RANGE: 30,000 to 415,000

GAS: Natural

| Fig. No. | Price |
|----------|-------|
| 66877 | |

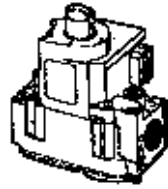

VR8305

DUAL VALVE COMBINATION GAS CONTROL for electronic hot surface (HSI) and direct spark (DSI) ignition systems. Used with S89C, -E, -F and

S87 ignition modules. Replaces Honeywell VR8450, -8405; White-Rodgers 36E36, -38, 36C68;

Robertshaw 7200DER. Same valve action and features as VR8304 but without pilot control.

MFG. NO.: VR8305M3506

SIZE IPT (inletxoutlet): 1/2x3/4"

BTUH CAPACITY RANGE: 30,000 to 415,000

GAS: Natural

| Fig. No. | Price |
|----------|-------|
| 82494 | |

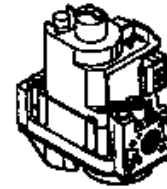

VR8300

COMPACT DUAL VALVE COMBINATION GAS CONTROL for standing pilot systems. A compact, universal valve with wide range capacity for use in standing pilot

furnaces, boilers, space heating appliances, wall heaters, etc. Meets ANSI safety standards requiring dual-seated (or single-seated with ECO) shut-off. Servo type regulator with screw adjustment; LP conversion kit included.

MFG. NO.: VR8300A4508

SIZE IPT (inletxoutlet): 3/4 x 3/4"

BTUH CAPACITY RANGE: 30,000 to 300,000

GAS: Natural

| Fig. No. | Price |
|----------|-------|
| 50790 | |

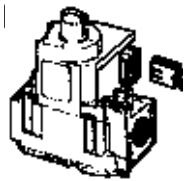

VR8345

UNIVERSAL COMBINATION GAS CONTROL for electronic ignition. This compact, high capacity valve can be used to replace hundreds of gas valves used in intermittent pilot, hot surface and direct spark igni-

tion systems. Ideal for service inventory, the VR8345 valve fits even limited space applications such as mobile home and wall furnaces with only a 4" swing radius. Adapter bushings, LP gas conversion kit and terminal block jumper included.

MFG. NO.: VR8345M4302

SIZE IPT (inletxoutlet): 3/4 x 3/4"

BTUH CAPACITY RANGE: 30,000 to 300,000

GAS: Natural

| Fig. No. | Price |
|----------|-------|
| 82492 | |

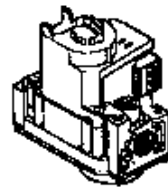

VR8205

DUAL VALVE COMBINATION GAS CONTROL for electronic direct spark (DSI) ignition systems. Used with S86d, -C and S89E, -F control modules. Replaces Honeywell VR8450;

White-Rodgers 36E36, -38. Solenoid operated valve opens under regulator control, closes if gas or power supply is interrupted. Meets codes requiring dual safety shutoff.

MFG. NO.: VR8205A2024

SIZE IPT (inletxoutlet): 1/2x1/2"

BTUH CAPACITY RANGE: 150,000

GAS: Natural or LP

| Fig. No. | Price |
|----------|-------|
| 82493 | |

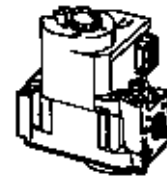

VR8204

DUAL VALVE COMBINATION GAS CONTROL for intermittent pilot systems. A compact combination control which combines manual valve, two automatic single-

stage operators, servo type regulator and pilot filter, and meets code requirements for dual-seated safety shutoff. For use with S86 and S8600 modules, this valve can be used as a direct replacement for Honeywell VR8440, White-Rodgers 36E36, -38, Robertshaw 7100DER, 700-070 models in spark-to-pilot systems. Compact size and reduced swing radius make the VR8204 an ideal "universal" valve for service truck and parts room inventories. Electrical rating: 24v AC. Swing radius: 3-5/8"

MFG. NO.: VR8204A2076

SIZE IPT (inletxoutlet): 1/2x1/2"

BTUH CAPACITY RANGE: 150,000

GAS: Natural & LP

| Fig. No. | Price |
|----------|-------|
| 44800 | |

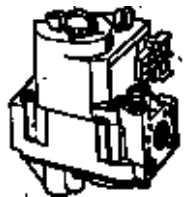

VR8200

DUAL VALVE COMBINATION GAS CONTROL for standing pilot systems. For use in 24 volt continuous standing pilot equipment. replaces most Honeywell and competitive brand valves up to 130,000 BTUH; widely used by equipment manufacturers as OEM valve.

Functions as combination manual valve, dual seated

automatic operators, and servo type regulator. Solenoid operated first automatic valve opens on thermostat call for heat, closed when call is satisfied. Diaphragm-operated second automatic valve opens under control of pressure regulator, closes upon interruption of gas or power supply. Features straight-thru design and lite-rite (off-pilot-on) lighting sequence.

Electrical rating: 24v AC. Swing radius: 3-5/8"

MFG. NO.: VR8200A2132

SIZE IPT (inletxoutlet): 1/2x1/2"

BTUH CAPACITY: 130,000

GAS: Natural

| Fig. No. | Price |
|----------|-------|
| 49278 | |



Q314 PILOT BURNER

Non primary, aerated insert

orifice type pilot burner. Provides main burner ignition. Use with Z340 thermocouple or, for millivolt applications, with Q313 generators. Suitable for natural or LP gas (shipped with .018 orifice for natural gas; and .010" orifice for LP applications).

| MFG. NO. | Fig. No. | Price |
|-----------|----------|-------|
| Q314A6102 | | 44699 |
| Q314A4586 | | 41437 |
| Q314A6094 | | 38588 |



REPLACEMENT GENERATOR CARTRIDGES for CS 82 powerpile pilot burners.

| Fig. No. | Price |
|----------|-------|
| 35012 | |

ACCUSTAT LOW VOLTAGE SINGLE STAGE CONTROL



DESCRIPTION:

High efficiency solid state thermostats for low voltage single stage systems. No bimetallic elements are used. Advantages include choice of either preset or adjustable mercury sensors, high accuracy, no temperature drift, and tamper-proof design. Built-in locking cover requires a special key.

APPLICATIONS

Ideal for commercial and industrial installations where accurate, tamper-proof control is required. Examples are fast-food stores, restaurants, churches, schools, retail stores, etc.

ACCUTEMP SENSORS:

This ACCUSTAT series uses preset or adjustable snap-in sensors. When temp. reaches the sensor setting, a circuit is completed, activating the solid state circuit within the case. This circuit turns heating and/or cooling system relays ON and OFF as required.

| MODEL | # OF SENSORS REQ'D | TEMP SETTINGS | VOLTAGE /LOAD | SWITCHES | FIG. NO. | PRICE |
|-------|--------------------|---------------|---------------|----------------|----------|-------|
| LH1 | 1 | 1 | 24-30 | Syst Off/On | 8723 | |
| LH2 | 2 | 2 | 24-30 | Syst Lo/Off/Hi | 8724 | |

ACCUTEMP SENSORS

The ACCUSTAT series uses preset or adjustable snap-in sensors. When temperature reaches the sensor setting, a circuit is completed, activating the solid state circuit within the case. This circuit turn heating and/or cooling system relays ON and OFF as required.

| DEGREE | FIG. NO. |
|--------|----------|
| 64 | 8752 |
| 65 | 8759 |
| 66 | 8810 |
| 68 | 8817 |
| 70 | 8825 |
| 72 | 8827 |
| 74 | 8831 |
| 75 | 51408 |
| 76 | 43716 |
| 78 | 38811 |
| ADJ | 38833 |

PROGRAMMABLE THERMOSTATS

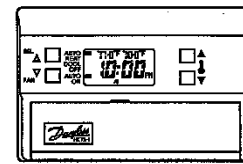

- *Modern design matches any decor
- *Saves energy, improves comfort
- *"Smart Fan" (HC models only)

- *Compatible with Residential or Commercial Systems.
- *User friendly programming
- *Up to 6 events per day.
- *Vacation mode.
- *One-touch for daylight savings to standard time.
- *Remote sensor models available.
- *Heat pump models available.
- *Escutcheon available.

| TYPE | FIG. NO. | PRICE |
|----------------------------|----------|-------|
| Heat/Cool | 85324 | |
| Heat Pump | 85329 | |
| Heat/Cool w/ remote sensor | 85327 | |
| Heat pump w/ remote sensor | 85328 | |
| Heat Only | 85325 | |
| Heat Only w/ remote sensor | 85326 | |

THERMOSTAT LOCK BOXES

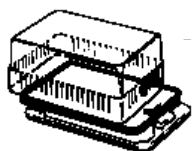

UNIVERSAL series (plastic) thermostat guard. Fits most wall thermometers. Packaged with solid base and ring base. 8.13 x 4.63 x 3.25.

CLEAR PLASTIC

| FIG. NO. | PRICE |
|----------|-------|
| 8999 | |

OPAQUE PLASTIC

| FIG. NO. | PRICE |
|----------|-------|
| 9001 | |

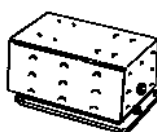

UNIVERSAL series (metal) thermostat guard.

Inside dimensions :

H-7 1/4 x W-5 3/8" x D-3 1/2"
Solid base.

| FIG. NO. | PRICE |
|----------|-------|
| 9005 | |

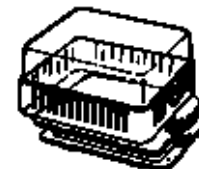

CLASSIC series (plastic) thermostat guard. Packaged with solid base and ring base. Inside dimensions :H-5 1/4 x W-4 5/8" x D-3"

METAL

| FIG. NO. | PRICE |
|----------|-------|
| 8992 | |

CLEAR PLASTIC

| FIG. NO. | PRICE |
|----------|-------|
| 8964 | |



REGAL series (plastic) thermostat guard. Fits most wall thermometers. Packaged with solid base and ring base.

Solid Base: H-6 3/8" x W-3 1/2" x D-3"
Ring Base: H-6 3/8" x W-3 1/2" x D-3 1/4"

Opaque plastic.

| FIG. NO. | PRICE |
|----------|-------|
| 8896 | |

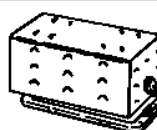

REGAL series (metal) thermostat guard. Rugged maximum protection.

6.38 x 3.5 x 3

| FIG. NO. | PRICE |
|----------|-------|
| 8904 | |

HONEYWELL OEM ALSO AVAILABLE!

THERMOSTATIC RADIATOR VALVES

DANFOSS

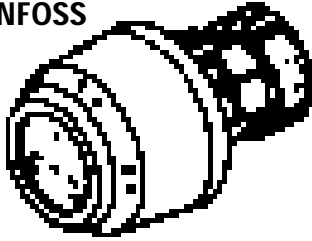

Operator with valve-mounted sensor and dial built in.

| FIG. NO. | PRICE |
|----------|-------|
| 54078 | |

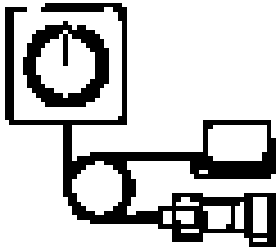

Operator with separate remote-mounted sensor and dial. 2x6' capacity tubes.

| FIG. NO. | PRICE |
|----------|-------|
| 54089 | |



Side mount angle valve body. Hot water and 2 pipe, low pressure steam systems.

| SIZE | FIG. NO. | PRICE |
|-------|----------|-------|
| 1/2 | 54091 | |
| 3/4 | 54026 | |
| 1 | 54075 | |
| 1 1/4 | 54092 | |

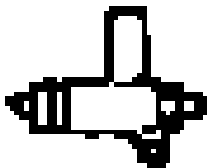

1/8" NPT-1-PS with vacuum breaker. For 1" pipe, low pressure steam

| FIG. NO. | PRICE |
|----------|-------|
| 54112 | |



Operator with valve-mounted dial and remote sensor. Remote 6' capacity tube.

| FIG. NO. | PRICE |
|----------|-------|
| 54025 | |

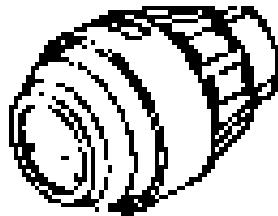

Operator with valve-mounted sensor and dial. Built-in tamper-proof.

| FIG. NO. | PRICE |
|----------|-------|
| 54090 | |

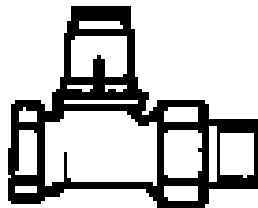

Straight valve body. Hot water and 2 pipe, low pressure steam systems.

| NPT | FIG. NO. | PRICE |
|--------|----------|-------|
| 1/2" | 54077 | |
| 3/4" | 50976 | |
| 1" | 50975 | |
| 1 1/4" | 54094 | |

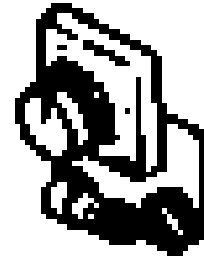

ALSO AVAILABLE: HONEYWELL, TACO AND B&G

Operator with combined remote-mounted sensor and dial. Wall mount with 6' capacity tube.

| FIG. NO. | PRICE |
|----------|-------|
| 54088 | |

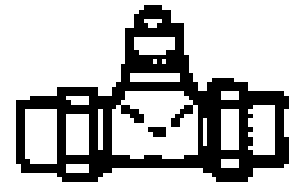

Straight valve body. For hot water only.

| 1/2" SOLDER | |
|-------------|-------|
| FIG. NO. | PRICE |
| 54110 | |

| 3/4" SOLDER | |
|-------------|-------|
| FIG. NO. | PRICE |
| 54111 | |



Angle valve body. Hot water and 2 pipe low pressure steam systems.

| SIZE | FIG. NO. | PRICE |
|--------|----------|-------|
| 1/2" | 54096 | |
| 3/4" | 54097 | |
| 1" | 54107 | |
| 1 1/4" | 54108 | |

DON'T SEE WHAT YOU'RE LOOKING FOR?

CALL OUR HEATING EXPERTS!

610-275-4453

TACO CIRCULATOR PUMPS

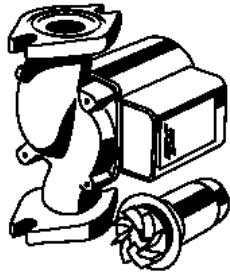

007 Cartridge Circulators Water lubricated circulators featuring patented stay-clean design. Exclusive replacement cartridge

restores pump to service quickly and economically - not necessary to replace entire motor assembly.



110 Red Baron Circulators The standard of the industry! Most popular residential seal-type circulator.

Quiet, dependable pumping power and long-lasting performance. Features one-piece high tension spring steel coupler, rugged bronze sleeve bearing assembly, oil saturated felt pad lubrications system, stainless steel shaft and a one-piece, dynamically balanced impeller.



Compact, all bronze, water lubricated circulator. Circulates or recirculates domestic hot water and equipped with a 1/40 HP motor.

COMPARE-YOU'LL TAKE TACO!

| FIG. NO. | OEM # | CONNECTION | HP | FACE/FACE DIM | PRICE |
|----------|-----------------|----------------------|------|---------------|-------|
| 21171 | 006-B4 | 3/4 Sweat | 1/40 | 5" | |
| 45447 | 005-F2 | 3/4, 1, 1 1/4, 1 1/2 | 1/35 | 6 11/32" | |
| 9536 | 007-F | 3/4, 1, 1 1/4, 1 1/2 | 1/25 | 6 11/32" | |
| 45458 | 007-F Bronze | 3/4, 1, 1 1/4, 1 1/2 | 1/25 | 6 11/32" | |
| 9538 | 008-F | 3/4, 1, 1 1/4, 1 1/2 | 1/25 | 6 11/32" | |
| 45449 | 009-F | 3/4, 1, 1 1/4, 1 1/2 | 1/8 | 6 11/32" | |
| 45453 | 009-F Bronze | 3/4, 1, 1 1/4, 1 1/2 | 1/8 | 6 11/32" | |
| 45451 | 0010F | 3/4, 1, 1 1/4, 1 1/2 | 1/8 | 6 11/32" | |
| 45455 | 0010F Bronze | 3/4, 1, 1 1/4, 1 1/2 | 1/8 | 6 11/32" | |
| 48858 | 0011F | 3/4, 1, 1 1/4, 1 1/2 | 1/8 | 6 1/2 | |
| 48861 | 0011F Bronze | 3/4, 1, 1 1/4, 1 1/2 | 1/8 | 6 1/2 | |
| 48859 | 0012F HV | 1 1/4 & 1 1/2 | 1/8 | 8 1/2 | |
| 48862 | 0012F HV Bronze | 1 1/4 & 1 1/2 | 1/8 | 8 1/2 | |
| 48860 | 0012F 2" | 2 | 1/8 | 8 1/2 | |
| 48863 | 0012F 2" Bronze | 2 | 1/8 | 8 1/2 | |
| 72742 | 0013F | 3/4, 1, 1 1/4, 1 1/2 | 1/8 | 6 1/2 | |
| 83327 | 0013BF | 3/4, 1, 1 1/4, 1 1/2 | 1/8 | 6 1/2 | |
| 72743 | 0014F | 3/4, 1, 1 1/4, 1 1/2 | 1/8 | 6 1/2 | |
| 83328 | 0014BF | 3/4, 1, 1 1/4, 1 1/2 | 1/8 | 6 1/2 | |

TACO CIRCULATING PUMPS

| FIG. NO. | OEM # | CONNECTION | HP | FACE/FACE DIM | PRICE |
|----------|------------|----------------------|-----|---------------|-------|
| 9540 | 110 | 3/4, 1, 1 1/4, 1 1/2 | 1/2 | 6 5/8 | |
| 9545 | 110 Bronze | 3/4, 1, 1 1/4, 1 1/2 | 1/2 | 6 5/8 | |
| 44781 | 111 | 3/4, 1, 1 1/4, 1 1/2 | 1/8 | 8 3/4 | |
| 27390 | 112 | 3/4, 1, 1 1/4, 1 1/2 | 1/3 | 6 3/4 | |
| 47206 | 113 | 3/4, 1, 1 1/4, 1 1/2 | 1/8 | 8 1/2 | |
| 22475 | 120 | 2 | 1/6 | 11 | |

TACO PUMP PARTS

| PUMP | COUPLER | PRICE | MECH SEAL | PRICE | BEARING CART | PRICE | FLANGE GASKET | PRICE |
|-------------------------|---------|-------|-----------|-------|-------------------|-------|---------------|-------|
| 1600&121Thru 138 | - | | 15388 | | 41087 | | 48914 | |
| 1600&121 Thru 138Bronze | - | | 59376 | | 41087 | | 48914 | |
| 110 | 40081 | | 15386 | | Bearing Ass 15390 | | Flg Gskt | |
| 110 Bronze | 40081 | | 15386 | | 22446 | | 44991 | |

TACO CIRCULATOR FLANGES

| SIZE | STD CT | PRICE | STD BRNZ | PRICE | ISOLAT FLANGE | PRICE | HVCT | PRICE | HVBRONZE | PRICE |
|-------|--------|-------|----------|-------|---------------|-------|-------|-------|----------|-------|
| 3/4 | 9546 | | 9550 | | 40133 | | - | | - | |
| 1 | 9547 | | 9551 | | 40134 | | - | | - | |
| 1 1/4 | 9548 | | 9552 | | 40135 | | 48864 | | 48867 | |
| 1 1/2 | 9549 | | 9553 | | - | | 48865 | | 48868 | |
| 2 | 48866 | | 48869 | | - | | - | | - | |

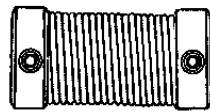

Coupler
for 110
circulator
1/2" x 3/8"
shaft
110-009

| FIG. NO. | PRICE |
|----------|-------|
| 40081 | |

**REPLACEMENT
CARTRIDGE**



for 007 cir-
culators.
Complete cir-
culating asembly
includes impeeler, bear-
ings, shaft and seals.
Allows quick replacment
of all circulating parts
(except motor) without
removing pump body from
piping.

| FIG. NO. | PRICE |
|----------|-------|
| 15391 | |

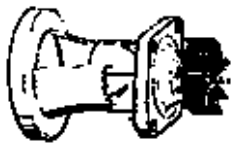

**REPLACEMENT BEARING
ASSEMBLY** for In-Line
circulators.

| FIG. NO. | PRICE |
|----------|-------|
| 15391 | |



REPLACEMENT MOTOR
for In-Line circulators.
TACO 110-223RP 1/12 HP
110 V motor.

| FIG. NO. | PRICE |
|----------|-------|
| 22796 | |

TACO

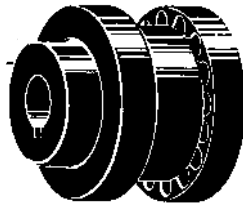

Woods Sure-Flex Couplers

When ordering, pelase indi-
cate desired bore of flange.
Other sizes also available.
Fits B&G, Thrush, Paco, Taco,
Aurora, Peerless and many
others!

| DESCR | FIG. NO. | PRICE |
|--------------|----------|-------|
| 3JE Sleeve | 41440 | |
| 4JE Sleeves | 41441 | |
| 4E Sleeves | 41442 | |
| 55E Sleeves | 41443 | |
| 5E Sleeves | 41444 | |
| 6JE Sleeves | 41445 | |
| 6E Sleeves | 41446 | |
| 7JE Sleeves | 41447 | |
| 7E Sleeves | 41448 | |
| 8JE Sleeves | 41449 | |
| 8E Sleeves | 41450 | |
| 9JE Sleeves | 41451 | |
| 9E Sleeves | 41452 | |
| 10JE Sleeves | 41453 | |
| 10E Sleeves | 41454 | |

| DESCR | FIG. NO. | PRICE |
|------------|----------|-------|
| 3JE Flange | 10821 | |
| 4JE Flange | 10823 | |
| 5JE Flange | 10828 | |
| 5S Flange | 10830 | |
| 6J Flange | 10834 | |
| 6S Flange | 10836 | |
| 7S Flange | 18860 | |
| 8S Flange | 10862 | |
| 9S Flange | 10864 | |

FLANGE GASKETS

for "00" and In-Line
circulators.



| DESCR | FIG. NO. | PRICE |
|--------------|----------|-------|
| O-Ring Style | 44991 | |
| 2-Hole Style | 19142 | |

TACO ZONE VALVES



2-Way

TACO ZONE VALVE each with its own Taco thermostat, permit accurate temperature control of individual rooms or groups of rooms in residences or commercial buildings. Exclusive heat motor functions silently. Beryllium copper metal bellows separates system water from the atmosphere for positive, leak proof operation. Easy to service replacement power head.



| SIZE | FIG. NO. | PRICE |
|--------|----------|-------|
| 3/4" | 9554 | |
| 1" | 9555 | |
| 1 1/4" | 15384 | |

POWER HEAD ONLY

| FIG. NO. | PRICE |
|----------|-------|
| 9568 | |

| 3-Way | | |
|-------|----------|-------|
| SIZE | FIG. NO. | PRICE |
| 1/2" | 48917 | |
| 3/4" | 54280 | |

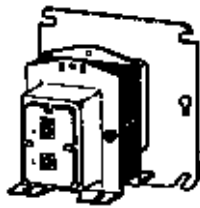

NEMA Rated Transformers. General purpose designed to operated any 24v AC control system. Meets NEMA standard for "Type D" transformers. 9" color coded leads; mounts on 4x4", 2x4" or octagon junction boxes, foot mount or junction box knockout.

| FIG. NO. | PRICE |
|----------|-------|
| 49981 | |

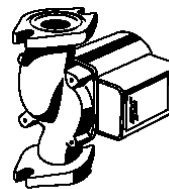

007-ZF4 Zoning Circulator less flanges. Built-in transformer and relay control eliminate the additional relay box. All wiring is done at circulation reducing installation time.

| FIG. NO. | PRICE |
|----------|-------|
| 50439 | |



TACO THERMOSTAT, specifically designed to obtain maximum service life from Taco Zone Valves. Heat Anticipator is factory set to provide the most energy efficient control of room temperature.

| FIG. NO. | PRICE |
|----------|-------|
| 41060 | |

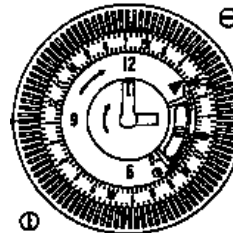

Taco Timer 265-1 "00" timer. 24 hour clock timer, adjustable to 15 minute intervals within 24 hour time frame. Temperature control available 95°F on 115°F off. Snap on 3/4" copper pipe.

| FIG. NO. | PRICE |
|----------|-------|
| 51754 | |

MOTORTROL HYDRONIC CONTROL VALVES



Two-way and three way fan coil valves desigend for chilled water, hot water and low pressure steam applications.
 1/2" sweat fittings
 Motor driven spring return
 Normally closed operation
 100% shut off
 300 PSI system pressure

T Y P E A

| TYPE | VOLTAGE | MFG NO. | PRICE |
|-------|---------|---------------|-------|
| 2-way | 120 | 0654C0307GB00 | |
| 2-way | 24 | 0654C0307GA00 | |

T Y P E B

| NO. | TYPE | VOLTAGE | MFG NO. | PRICE |
|-------|------|---------------|---------|-------|
| 3-way | 120 | 0654C0309GB00 | | |
| 3-way | 24 | 0654C0309GA00 | | |

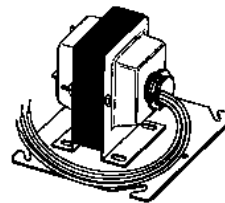

Taco Transformer. Reduces line voltage to low voltage when used in conjunction with Taco Zone Valves. UL listed and CSA approved. Can handle up to 3 Taco Zone Valves.

| FIG. NO. | PRICE |
|----------|-------|
| 41059 | |



HYDRONIC ZONE VALVES

Designed for baseboard applications - heating only
 3/4" inverted flare "quikonnect fitting - ideal replacement valve
 Normally closed operation with end switch
 Easy removal and installation



| TYPE | VOLTAGE | MFG. NO. | PRICE |
|-------|---------|---------------|-------|
| 2-WAY | 24 | 0767C0036GA0 | |
| 3-WAY | 24 | 0767C0008GA01 | |

BELL & GOSSETT
BELL & GOSSETT PUMPS

For hydronic heating and cooling systems and water heating service Bell & Gossett Booster pumps represent a long process of refinements for performance improvement. Over 8,000,000 sold. All B&G booster pumps have these quality features:

- *Quiet, vibrationless B&G built UL listed motor
- *Oversized, super-finished shaft
- *Long sleeve-type bronze bearings
- *Noise dampening coupler
- *Continuous oil lubrication system
- *True centrifugal impeller
- *Bearing assembly designed for top performance and easy service.

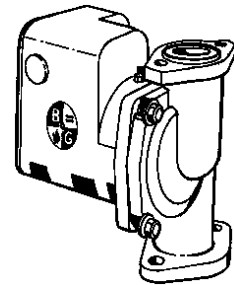
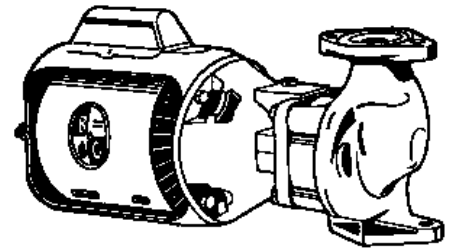

| CIRCULATOR PUMP | FIG. NO. | PRICE |
|---------------------|----------|-------|
| #100 | 7803 | |
| 2" with flanges | 29744 | |
| HV | 7827 | |
| HV Bronze | 25249 | |
| PR CI Pump | 33212 | |
| PR Bronze | 33213 | |
| 100 Bronze | 7833 | |
| 2" Bronze w/ flange | 7834 | |

**ALL B&G PUMPS
 AVAILABLE AT
 DUFF!**

| PER PAIR | 3/4" | PRICE | 1" | PRICE | 1 1/4" | PRICE | 1 1/2" | PRICE |
|-----------------------|------|-------|-------|-------|--------|-------|--------|-------|
| #100 Flanges CI | 7839 | | 40103 | | 40104 | | 40105 | |
| HV & Pr Flanges | | | 48528 | | 40106 | | 40107 | |
| Flange Bronze | 7846 | | 40108 | | 40109 | | 40110 | |
| HV & Pr flange bronze | | | 40111 | | 40112 | | 40113 | |

GRUNDFOS CIRCULATORS
 Cast Iron / Stainless Steel Construction



| FIG. NO. | MODEL | DESCR | PRICE |
|----------|-----------|------------|------------|
| 53042 | UPS15-42F | 3 speed | SS Circ PU |
| 32645 | UP15-42F | Circulator | |
| 41913 | UP26-64F | Circulator | |
| 41243 | UP26-96F | Circulator | |
| 46989 | UP26-99F | Circulator | |
| 52244 | UP26-99F | 230v 1ph | |
| 41244 | UP43-75F | Circulator | |
| 41246 | UP15-42SF | Circulator | |
| 49124 | UP25-64SF | SS | |
| 52666 | UP26-96BF | Circulator | |
| 52667 | UP26-96BF | 115v Circ | |
| 41245 | UP43-75BF | 230v Circ | |
| 57457 | UP15-42SU | Circulator | |

RANGE BOILERS
 Galvanized range boilers with six openings

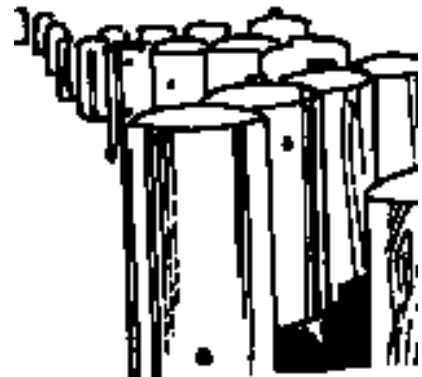

| GALLONS | SIZE | FIG. NO. | PRICE |
|---------|-------|----------|-------|
| 30 | 12x60 | 35853 | |
| 40 | 14x16 | 35854 | |
| 82 | 20x60 | 35856 | |
| 120 | 24x60 | 35857 | |

For additional information call: 610-275-4453 or Fax: 610-279-6299
 Please call for current prices.

B&G BOOSTER PUMP PARTS



Flange Tool - To install and remove circular flanges.



| FIG. NO. | PRICE |
|----------|-------|
| 7215 | |

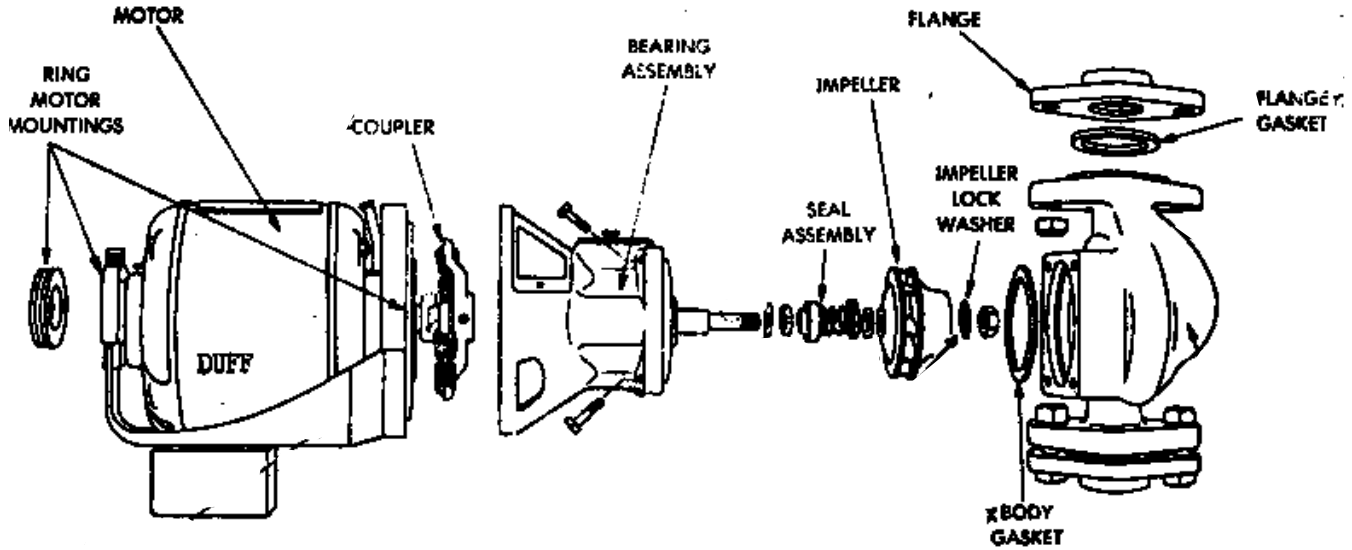

ALL PARTS FOR B&G PUMPS ARE READILY AVAILABLE!

| PUMP | BEARING ASSEMBLY | | IMPELLER | | COUPLER | | BODY GASKET | | SEAL | | MOTOR MOUNT | | BODY GASKET | |
|-------------------|-------------------------------------|-------|----------|-------|----------|-------|-------------|-------|----------|-------|-------------|-------|-------------|-------|
| | FIG. NO. | PRICE | FIG. NO. | PRICE | FIG. NO. | PRICE | FIG. NO. | PRICE | FIG. NO. | PRICE | FIG. NO. | PRICE | FIG. NO. | PRICE |
| | Series 100 3/4", 1", 1 1/4", 1 1/2" | 8335 | 8440 | 8308 | 38892 | 8071 | 8301 | 8153 | 38892 | | | | | |
| Series 100 Bronze | 8403 | 22113 | 8308 | 38892 | 8071 | 8301 | 8153 | 38892 | | | | | | |
| HV & 2" Iron | 8428 | 8434 | 8424 | 39096 | 8090 | 8301 | 8153 | 39096 | | | | | | |
| HV & 2" Bronze | 8431 | 41334 | 8424 | 39096 | 8090 | 8301 | 8153 | 39096 | | | | | | |
| PR Iron & Bronze | 8417 | 8259 | 8308 | 8443 | 44789 | 8301 | 8165 | 8443 | | | | | | |
| 2 1/2 LD3 | 8417 | 8226 | 8331 | 8443 | 32784 | 8301 | 8165 | 8443 | | | | | | |
| HD-3 | 8417 | 8223 | 8331 | 8443 | 52370 | 8301 | 8165 | 8443 | | | | | | |
| 60-11-S | 8397 | 56327 | 8231 | 17558 | 53825 | 8301 | 8165 | 17558 | | | | | | |
| 60-13-S | 8397 | 55392 | 8231 | 17558 | 8086 | 8301 | 8165 | 17558 | | | | | | |
| 60-14-S | 8397 | 59844 | 8231 | 17558 | 40057 | 8301 | 8165 | 17558 | | | | | | |
| 60-15-S | 8371 | - | 8384 | 8452 | 8086 | 8389 | 8165 | 8452 | | | | | | |
| 60-16-S | 8371 | - | 8384 | 8452 | 40057 | 8389 | 8165 | 8452 | | | | | | |
| 60-17-S | 8371 | - | - | 8452 | 50866 | 8389 | 8165 | 8452 | | | | | | |

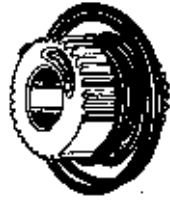

SPIRALINK PERMANENT REPLACEMENT COUPLING for B&G, Theo and Armstrong pumps.

- ⊗ Single Retrofit eliminates future coupling replacement
- ⊗ Easy Installation reduces labor hours and down-time
- ⊗ Superior Flexibility extends pump life by absorbing torque load on bearings and seals
- ⊗ Model Versatility reduces coupler inventory up to 70%



| B&G | Armstng | HP | Rot | SHAFT | B&G | Armstrong | FIG. NO. | PRICE |
|-------------------------|---------|-------|------------------------|---------------------------|---------------------|-----------|----------|-------|
| 75 100 125 150 | 5-25 | 1 1/2 | ↑ CCW ↓ | 1/2 X 1/2 | 118705 OR 189110 | 806026 | 46960 | |
| 1-1/2" | 5-34 | 1/6 | | | 118473 OR 118723 | 806168 | | |
| 2" | 5-35 | | | | | | | |
| 2 1/2" LD3 | 5-45 | 1/4 | | | 118705 OR 189110 | 806026 | | |
| HD3 | S-46 | 1/3 | | | | | | |
| HV 1" | | 1/6 | | | 118473, | | | |
| HV 1-1/4" | | | | | | | | |
| HV 1-1/2" | H-32 | | | | | | | |
| 1"PR | H-41 | | | | | | | |
| PD-35 | 5-55 | 2/3 | | | ↑ CW ↓ | 1/2 X 1/2 | | |
| PD-37 | 5-57 | 3/4 | OR 1/2X5/8 | | | 812734 | 48658 | |
| PD-38 | 5-60 | 1 | 1/2 X 5/8 | 118476 or P77271 | | 816665 | | |
| PD-39 | | | OR 5/8X5/8 | | | | | |
| Old # New | | | | | | | | |
| 60-1 60-11 | H-51 | 1/4 | B&G 1/2 X 1/2 | 118473 | | 807436 | 46961 | |
| 60-2 | H-52 | 1/3 | | | | | | |
| 60-3 60-13 | H-53 | 1/2 | Armstrong 1/2 x 5/8 | 118709 or P77234 | | 806137 | | |
| 60-4 60-14 | H-54 | 3/4 | | | | | | |
| 60-5 60-15 | H-63 | 1/2 | 1/2 x 5/8 | 186410 or P77234 | | 812734 | 48658 | |
| 60-6 60-16 | H-64 | 3/4 | | | | | | |
| 60-8 | H-66 | | | 5/8 x 5/8 | 118476 or P77271 | 816665 | | |
| | H-65 | 1 | | | | | | |
| | H-67 | | | 1/2 x 1/2 or 1/2 x 5/8 | 118473 or 118709 | | 46961 | |
| | 60-17 | | | | | | | |
| | 60-19 | | | | | | | |
| Taco Model | | HP | ROT | SHAFT | COMPARTNO. | | FIG. NO. | |
| 121 | | 1/4 | CCW | 1/2X1/2 | 1624-053RP | | 48659 | |
| 122 | | 1/4 | ↓ | OR | (Woods 3J or 4J) | | | |
| 131 | | 1/3 | | 1/2 X 5/8 | | | | |
| 132 | | 1/2 | | OR | | | | |
| 133 | | 3/4 | | 5/8 X 5/8 | | | | |
| 136 | | 1 | | | | | | |

EXPANSION TANKS



FILLTROL provides added filling control to the benefits of the EXTROL system. Includes a built-in valve and check valve for reducing supply water pressure and maintaining minimum system. Maximum working pressure: 100PSIG Maximum operating temperature 240°F. 1/2" FPT.

| FIG. NO. | MODEL # | TOTAL VOL.(GALS) | ACCEPT. VOL.(GALS) | DIAMETER (INS) | LENGTH | PRICE |
|----------|---------|------------------|--------------------|----------------|---------|-------|
| 8525 | 109 | | 1 | 8 | 14 3/4 | |
| 8530 | 110 | 4.4 | 2.5 | 11 | 17 3/4 | |
| 8771 | 111 | 7.6 | 2.5 | 11 | 24 5/16 | |
| 8772 | 112 | 14 | 11.5 | 15 3/8 | 23 | |



FILLTROL COMBINATION PACKAGE WITH AIR PURGE VENT - specify type and size air purger required. Max working pressure 100 PSIG Maximum operating pressure: 240°F.

| FIG. NO. | MODEL | PURGER SIZE | PRICE |
|----------|-------|-------------|-------|
| 60870 | 109 | 1" | |
| 60871 | 109 | 1 1/4" | |
| 60872 | 110 | 1" | |
| 60873 | 110 | 1 1/4" | |
| 60874 | 111 | 1 1/4" | |



AIR PURGER - 4" purger flanged available. Also available with 1/2" tap.

TAPPINGS

| FIG. NO. | SIZE | V | Z | PRICE |
|----------|-------|-----|-----|-------|
| 8463 | 1 | 1/8 | 1/2 | |
| 8467 | 1 1/4 | 1/8 | 1/2 | |
| 8470 | 1 1/2 | 1/8 | 1/2 | |
| 8472 | 2 | 1/2 | 1/2 | |
| 8474 | 2 1/2 | 3/4 | 1/2 | |
| 8477 | 3 | 3/4 | 1/2 | |

FILLTROL VALVE KIT - FIG. NO. 17797



EXTROL EXPANSION TANK - For use with closed hydronic heating and cooling systems. Max working pressure: 100 PSIG. Max operating temp 240°F. Shipped with standard 12 PSIG air charge which may be changed on the job to suit installation conditions. 1/2" FPT.

| FIG. NO. | TOTAL VOL. (GALS) | DIAMETER (INCHES) | LENGTH OR HEIGHT (INS) | PRICE |
|----------|-------------------|-------------------|------------------------|-------|
| 8507 | 2 | 8 | 12 5/8 | |
| 8512 | 4.4 | 11 | 15 1/2 | |
| 8513 | 7.6 | 11 | 23 | |
| 8515 | 14 | 15 3/8 | 21 | |



EXTROL COMBINATION PACKAGES. Price includes air purger and one float vent.

CALL NOW WITH YOUR SPECIFICATIONS!

AMERICAN AIR VENTS



| FIG. NO. | PIPE SIZE | TYPE | PRICE |
|----------|-----------|---------------------------|-------|
| 51068 | 1/8 MPS | Float Vent: up to 150 PSI | |
| 60736 | 1/4" MPS | Float Vent: up to 150 PSI | |
| AM706 | 3/4" MPS | Float Vent: up to 150 PSI | |



AIR ELIMINATOR - Cast iron, Max working pressure = 150 PSIG/Max working temp= 240°F.

| FIG. NO. | HEIGHT | WIDTH | SYSTEM TAPPING | PRICE |
|----------|--------|-------|----------------|-------|
| 36549 | 7 5/8 | 6 | 3/4" NPT | |



AIR SEPARATOR/ELIMINATOR - Cast iron, Max working pressure = 150 PSIG/Max working temp= 240°F.

| FIG. NO. | HEIGHT | WIDTH | SYSTEM TAPPING | PRICE |
|----------|--------|-------|----------------|-------|
| 3AM721 | 15 7/8 | 4 1/2 | 1" NPT | |

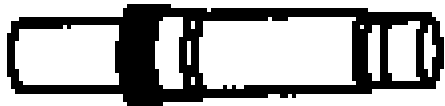

EXPANSION COUPLERS -
Temperature range: 40oF to 240oF. Working pressure up to 60 PSIG.

| FIG. NO. | NOM TUBE SIZE | LENGTH | | MAX O.D. | PRICE |
|----------------------------------|---------------|------------|----------|----------|-------|
| | | COMPRESSED | EXTENDED | | |
| NOMINAL COPPER TUBE SIZES | | | | | |
| 8480 | 3/4 | 5 | 7 1/2 | 1 3/8 | |
| 8487 | 1 | 5 7/16 | 8 | 1 5/8 | |
| 8490 | 1 1/4 | 5 3/4 | 8 1/2 | 1 7/8 | |
| NOMINAL FEMALE PIPE SIZES | | | | | |
| 8495 | 3/4 | 7 3/16 | 9 1/4 | 1 3/8 | |
| 8499 | 1 | 8 1/8 | 10 3/16 | 1 11/16 | |
| 8504 | 1 1/4 | 8 3/8 | 10 1/2 | 2 | |

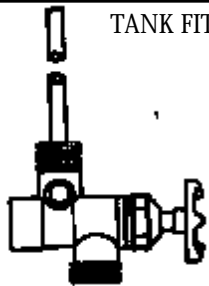

TANK FITTINGS for plain steel expansion tanks. 1/2" IPS.

| FIG. NO. | PRICE |
|----------|-------|
| 8800 | |

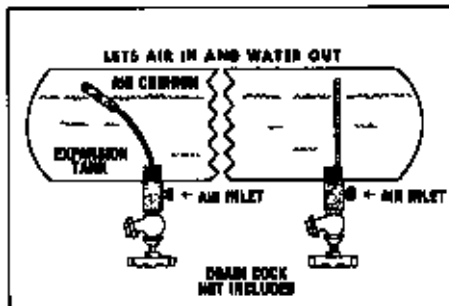

Expansion tank drainers. Flexible type may be used for tanks with side or bottom outlets. Rigid type is for bottom outlet only. All brass bodies.

| DESCR | FIG. NO. | PRICE |
|----------|----------|-------|
| FLEXIBLE | 38585 | |
| RIGID | 38674 | |



QUALITY EXPANSION TANK
NON-ASME CODE
HEAVY GAUGE WELDED
STEEL, TANK, PRIMER PAINT,
REINFORCED ENDS

TWO 1/2" FPT TAPPINGS

| GALLON | SIZE | FIG. NO. | PRICE |
|--------|-------|----------|-------|
| 12 | 12X24 | 14450 | |
| 15 | 12X30 | 14451 | |
| 18 | 12X36 | 14452 | |
| 24 | 12X48 | 14453 | |
| 30 | 12X60 | 14454 | |

For additional information call: 610-275-4453 or Fax: 610-279-6299
Please call for current prices.

FLEXIBLE CONNECTORS -
Working pressure for 1/2"=55 PSIG; for 3/4"=40 PSIG. Test pressure = 150 PSIG. 9" Copper tube-8" Flex-2 Copper tube

| FIG. NO. | COPPER TUBESIZE | PRICE |
|----------|-----------------|-------|
| 8781 | 1/2 | |
| 8782 | 3/4 | |



BALANCERS - Bronze,
Maximum working pressure=125 PSIG. Maximum operating temperature 250oF.

| FIG. NO. | SIZE | LENGTH | HEIGHT | PRICE |
|----------|-------|--------|--------|-------|
| 16697 | 1/2 | 1 5/8 | 1 7/8 | |
| 16700 | 3/4 | 2 1/8 | 2 1/8 | |
| 42545 | 1 | 2 3/4 | 2 7/16 | |
| 16706 | 1 1/4 | 2 3/4 | 2 1/2 | |



PURGE AND BALANCE VALVES

| FIG. NO. | SIZE | PRICE |
|----------|-------|-------|
| 8816 | 1/2 | |
| 8820 | 3/4 | |
| 8822 | 1 | |
| 8824 | 1 1/4 | |

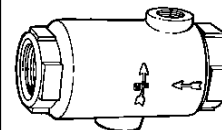

IN-LINE AIRTROL FITTINGS

B&G inline air separator fittings are designed for systems when the boiler will not accept a dip tube (Airtrol boiler fittings).

B&G Airtrol tank fittings must be used with the inline air separators to complete the air control system.

Airtrol tank fittings are not required when using the IAS inline air separator with diaphragm and bladder expansions tanks. To prevent accumulation of air in heating and cooling units and prevent noises caused by entrapped air. Specifically designed to efficiently separate air from circulating water in hydronic heating and cooling systems to assure quiet operation. NO MOVING PARTS! 175 PSI, 300oF.

| SIZE | FIG. NO. |
|-------|----------|
| 1 | 41552 |
| 1 1/4 | 41553 |
| 1 1/2 | 41554 |
| 2 | 41555 |
| 2 1/2 | 41556 |
| 3 | 41557 |

DIELECTRIC FITTINGS



DIELECTRIC UNION
Copper X Female
SWT X FIP

| SIZE | FIG. NO. | PRICE |
|-------|----------|-------|
| 1/2 | 5723 | |
| 3/4 | 5725 | |
| 1 | 5726 | |
| 1 1/4 | 5728 | |
| 1 1/2 | 5729 | |
| 2 | 5731 | |



DIELECTRIC UNION
Female IP

| SIZE | FIG. NO. | PRICE |
|-------|----------|-------|
| 1/2 | 49244 | |
| 3/4 | 44816 | |
| 1 | 49354 | |
| 1 1/4 | 49355 | |
| 1 1/2 | 49356 | |
| 2 | 49357 | |

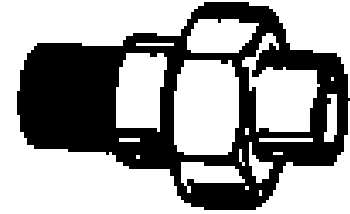

DIELECTRIC UNION
Copper x Male IP

| SIZE | FIG. NO. | PRICE |
|------|----------|-------|
| 3/4 | 53571 | |



DIELECTRIC UNION
FLANGED
Copper X Female

| SIZE | FIG. NO. | PRICE |
|-------|----------|-------|
| 2 | 84156 | |
| 2 1/2 | 36514 | |
| 3 | 50056 | |
| 4 | 62005 | |

BRAUKMAN PRESSURE REGULATING VALVE

Single union with threaded tailpiece, inlet and outlet both male threaded for union on either or both ends. 400 psi inlet; 15-150 ips outlet



| SIZE | FIG. NO. | PRICE |
|------|----------|-------|
| 1/2 | 44099 | |
| 3/4 | 44098 | |
| 1 | 44856 | |

FLO VALVES

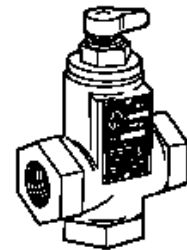

CAST IRON
STRAIGHT-ANGLE
PATTERN

| SIZE | FIG. NO. | PRICE |
|-------|----------|-------|
| 3/4 | 7880 | |
| 1 | 7881 | |
| 1 1/4 | 7882 | |
| 1 1/2 | 7883 | |
| 2 | 7886 | |
| 2 1/2 | 73303 | |
| 3 | 73304 | |

COPPER STRAIGHT
PATTERN

| SIZE | FIG. NO. | PRICE |
|------|----------|-------|
| 3/4 | 62008 | |

B&G FB38

Low pressure reducing valves equipped with a low inlet pressure check valve and removable strainer.

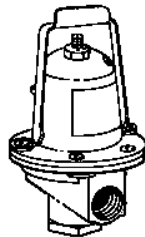

| FIG. NO. | PRICE |
|----------|-------|
| 41043 | |

REDUCING VALVE

Low pressure reducing valve is equipped with a low inlet pressure check valve and removable strainer. It is suitable for use in building with a maximum of three floors. 3/4"

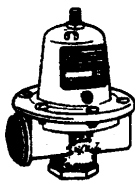

| FIG. NO. | PRICE |
|----------|-------|
| 41044 | |

NO. 6&7 HIGH PRESSURE REDUCING VALVES

Protects plumbing fixtures against excessive line pressures. All wetted part are brass. These valves are fitted with a removable strainer, low inlet pressure check valve and extra large diaphragm. They are factory adjusted to deliver 45 psi with 125 psi to the valve.

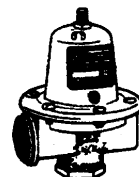

| DESCR | FIG. NO. | PRICE |
|---------|----------|-------|
| #6 1/2" | 39100 | |
| #7 3/4" | 33959 | |



SPIROVENT JUNIOR

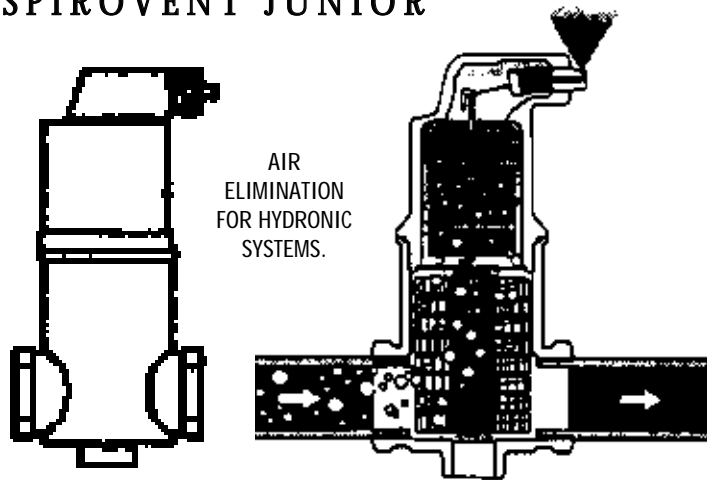

Use the "junior" for residential and light commercial jobs. It comes in 3/4", 1", 1 1/4" and 1 1/2" female-threaded sizes and is made of solid brass for long life. All models except for the 3/4" model are tapped 1/2" at the bottom to accommodate a bladder-type compression tank.

| SIZE | FIG. NO. | PRICE |
|--------|----------|-------|
| 3/4" | 76637 | |
| 1" | 76638 | |
| 1 1/4" | 76639 | |
| 1 1/2" | 84168 | |

SPIROVENT SENIOR

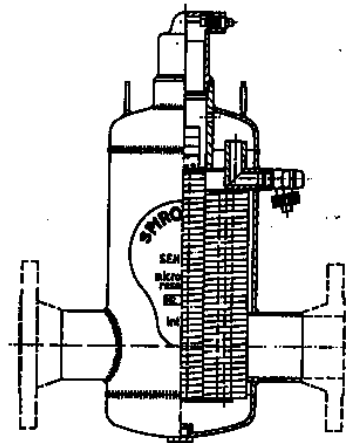

Use this mild-steel unit in larger commercial and industrial applications. With pipe sizes from 2" to 36" (male NPT, flanged, or weld connections), its operation is identical to and just as effective as the "juniors". The "senior" uses multiple Spirotube screens for maximum air separation. Its venting mechanism is mounted in a chamber inside the tank to protect it from system debris. You can also use the "senior" to remove floating dirt or liquids (oil, for instance) from the surface through a manually operated side valve. You can also use this valve during system start-up to quickly rid the system of large quantities of air.

ENHANCED AIR SEPARATOR



| SIZE | FIG. NO. | PRICE |
|--------|----------|-------|
| 1" | 56324 | |
| 1 1/4" | 60013 | |

ITT Bell & Gossett
Morton Grove, IL, U.S.A.

DESCRIPTION

The Bell & Gossett Model EAS Enhanced Air Separator is a highly efficient device for removing entrained air bubbles in hydronic systems. The combination diffuser and coalescing medium design makes possible the removal of very small air bubbles from the fluid stream by coalescence at substantial fluid velocity. The diffuser forces the system fluid to cover the entire inlet portion of the coalescing medium. The coalescing medium will collect air bubbles on its stainless steel filaments. As the bubbles coalesce together, they will rise to the top of the separator where they can be released to the atmosphere through the automatic air vent.

For additional information call: 610-275-4453 or Fax: 610-279-6299
Please call for current prices.



SPIROTOP

This unit provides reliable automatic air release in the top of a hydronic system, allowing rapid filling and draining. When used with a Spirovent, no other air bleeders are needed.

| FIG. NO. | PRICE |
|----------|-------|
| 80231 | |



CALL DUFF FIRST!

610-275-4453

WATTS RELIEF VALVES



WATTS 374A - Special pressure hot water boiler relief valve. 3/4" only. 550,000 BTU.



WATTS 530 - Calibrated pressure relief valve. Calibrated adjustment feature for setting valve to relief pressure. Adjustable range 50-175 lbs. All brass construction and stainless steel spring, Ideally suited as by-pass thermal expansion relief valve. 3/4".

| FIG. NO. | PRICE |
|----------|-------|
| 3842 | |

| FIG. NO. | PRICE |
|----------|-------|
| 3774 | |



WATTS 100XL - ASME rated, self-closing T&P relief valve for water heaters up to 100,000 BTU/hr. A thermostat with thermo-bonded (non-metallic) protective coating and a highly protective dielectric carrier to protect thermostat from accumulations of mineral deposits and galvanic corrosive action. Extends the effective life of the valve of overcoming problems created by adverse water conditions. Has test lever and 4" extension thermostat. Male inlet and female outlet. Pressure range 75-150 lbs. Standard setting - 150 lbs. Temperature relief 210oF. Thermostats with special protective coating, all bronze body, stainless steel spring, thermostat is accurate and proven exclusively designed and manufactured by Watts. AGA BTU 100,000.

DON'T LET THIS HAPPEN TO YOU!



| MODEL # | FIG. NO. | SIZE | HEIGHT (less thermostat) | WIDTH | WEIGHT (lbs) | AGA/CGA TEMP. STEAM BTU/hr | PRICE |
|---------|----------|--------|-----------------------------|-------|--------------|----------------------------------|-------|
| 100XL-4 | 3756 | 3 1/2" | 1 7/8" | 3/4 | 100,000 | | |

WATTS SERIES 40, 140, 240, 340

A.S.M.E. rated, ANSI Z21.22 "Relief valves and automatic gas shut-off devices" design certified by AGA and CA listed. Meets Military Spec. MIL-V-136-12D, Type I.

Temperature relief 210°F. Standard pressure settings 75, 100, 125 and 150 lbs.

For gas, electric or oil-fired storage water heaters between 180,000 and 200,000 BTU/hr. Rating: Use 3/4" No. 40, 140 series tested under ANSI Z21.22 with ratings as certified and listed by AGA and CGA.

For gas or oil-fired storage water heaters between 200,000 and 730,000 BTU/hr. output heating domestic water and for steam coil storage water heaters: Use No. 340, 342 series listed under ANSI Z21.22 with ratings as certified and listed by AGA and CGA.

Bronze body construction, Back-up emergency safety fuse plug, Vacuum relief valve vent in drain, Tamper-resistant bonnet screws, Thermostat is accurate and proven.

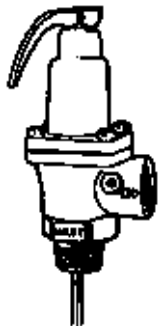

| MODEL | FIG. NO. | INLET | OUTLET | AGA-CGA TEMP. STEAM RATING BTU/hr | ASME PRESSURE STEAM RATING BTU/hr | PRICE |
|---------|----------|---------|---------|---|---|-------|
| 40XL-5 | 3725 | 3/4"M | 3/4"F | 200,000 | 777,600 | |
| 40XL-8 | 27885 | 3/4"M | 3/4"F | 200,000 | 777,600 | |
| 40XL-4 | 3734 | 1"M | 1"F | 500,000 | 1,155,000 | |
| 40XL-7 | 40706 | 1"M | 1"F | 500,000 | 1,155,000 | |
| 140S-3 | 44342 | 1"F | 1"F | 570,000 | 1,670,000 | |
| 140X-5 | 33251 | 1"F | 1"F | 670,000 | 1,670,000 | |
| N240X-6 | 3738 | 1"F | 1"F | 730,000 | 2,195,000 | |
| 340-3 | 3744 | 1 1/2"F | 1 1/2"F | 1,150,000 | 3,450,000 | |

WATTS WATER PRESSURE REGULATORS

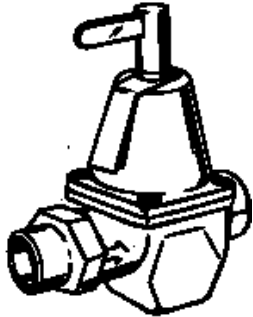

WATTS 1156F- Iron Feed Water Pressure Regulator. Features highest capacity performance (twice that of contemporary popular competitive makes) as well as unique simplified servicing accessibility for complete unitized maintenance. Max. Temp. 212°F Max Pressure 100 psi.

All 1/2" models furnished with a purge lever. Because of the exceptional high capacity feature of these Watts designs the lever is only necessary for purging of the system. When the lever is raised to a vertical position it manually forces the valve wide open. Returning the lever to its normal position permits the valve to maintain normal pressure in the system.

| FIG. NO. | MODEL | SIZE | INLET CONN UNION | HEIGHT | LENGTH | WEIGHT | PRICE |
|----------|--------|------|------------------|---------|--------|--------|-------|
| 3780 | 1156F | 1/2" | Thread | 5 5/16" | 3 1/2" | 2 1/8 | |
| 3784 | S1156F | 1/2" | Sweat | 5 5/16" | 4 1/8" | 2 1/4 | |
| 3782 | T1156F | 1/2" | Thread | 5 5/16" | 4 1/4" | 2 1/4 | |

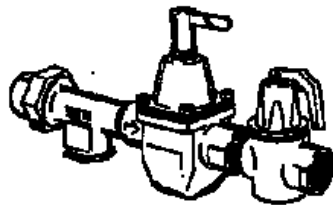

WATTS T145B- Bronze body, dual control. All bronze dual control consisting of feed water regulator, 30 lb. diaphragm relief valve and bronze body strainer. Max Temp 212°F Max Pressure 100 psi. 1/2". Union Threaded Inlet Connection.

| FIG. NO. | PRICE |
|----------|-------|
| 3803 | |

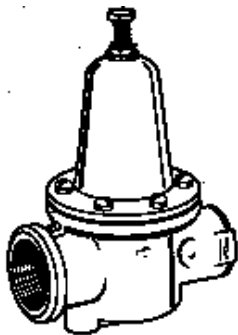

WATTS N256 Bronze Body Feed water Pressure Regulator. Tight seating check valve with integral strainer and unitized design for simplified servicing. Set at 15 psi. Max Temp 212°F. Max pressure 100 PSI.

| FIG. NO. | PRICE |
|----------|-------|
| 3788 | |

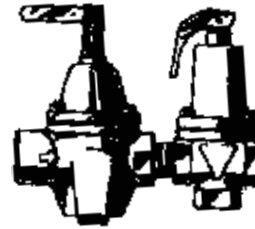

WATTS 1450F - Iron body dual control. Combines construction features of Watts 1156F and rugged iron body diaphragm relief valve. Set 30 lbs. Size 1/2" Max temp. 212°F.

| FIG. NO. | PRICE |
|----------|-------|
| 3792 | |

WATTS T1450F - Identical to above except furnished with union threaded inlet connection.

| FIG. NO. | PRICE |
|----------|-------|
| 3796 | |

WATTS S1450F - Identical to above except furnished with union sweat inlet connection.

| FIG. NO. | PRICE |
|----------|-------|
| 3799 | |

OTHER

MANUFACTURERS

AVAILABLE:

AMTROL, B&G,

HONEYWELL,

CASH ACME,

TACO...

AND MORE!

CALL US!

610-275-4453

WE SELL SOLUTIONS!



For additional information call: 610-275-4453 or Fax: 610-279-6299
Please call for current prices.

RELIEF VALVES

WATTS 174A - A.S.M.E. Water Pressure Safety Relief Valve - Bronze body safety relief valves for pressure protection only of all types of hot water heating boiler equipment. Pressure range 30 to 150 lbs. with corresponding high BTU/HR. Female inlet and outlet connections. Sizes 3/4" to 2". Meets Military Spec MIL-V-136-12D, Type III.

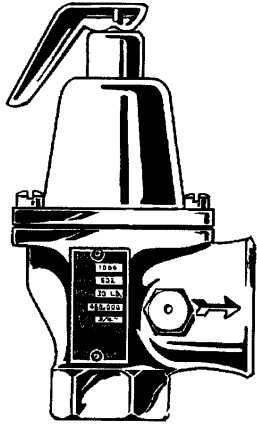

SETTING AND RELIEVING CAPACITIES

(National Board Certified Ratings) BTU Stemam Discharge Capacities

| SIZE | 30 LBS | 100 LBS | 125 LBS | 150 LBS |
|--------|-----------|-----------|------------|------------|
| 3/4" | 650,000 | 1,695,000 | 2,070,000 | 2,445,000 |
| 1" | 1,005,000 | 2,635,000 | 3,215,000 | 3,795,000 |
| 1 1/4" | 1,682,000 | 4,399,000 | 5,370,000 | 6,340,000 |
| 1 1/2" | 2,020,000 | 5,290,000 | 6,460,000 | 7,630,000 |
| 2" | 3,815,000 | 9,970,000 | 12,170,000 | 14,370,000 |

| SIZE | 30 # PSI | | 50 # PSI | | 75 # PSI | | 100 # PSI | | 125 # PSI | | 150 # PSI | | SPECIAL SET | |
|--------|----------|-------|----------|-------|----------|-------|-----------|-------|-----------|-------|-----------|-------|-------------|-------|
| | FIG. NO. | PRICE | FIG. NO. | PRICE | FIG. NO. | PRICE | FIG. NO. | PRICE | FIG. NO. | PRICE | FIG. NO. | PRICE | FIG. NO. | PRICE |
| 3/4 | 37414 | | 42487 | | 42488 | | 42489 | | 37415 | | 37416 | | 3826 | |
| 1" | 37417 | | 42490 | | 42491 | | 42492 | | 37418 | | 37419 | | 3830 | |
| 1 1/4" | 37420 | | 42493 | | 42494 | | 42495 | | 37421 | | 37422 | | 3835 | |
| 1 1/2" | 37423 | | 42496 | | 42497 | | 42498 | | 37424 | | 37425 | | 3838 | |
| 2" | 37426 | | 42499 | | 42500 | | 42501 | | 37427 | | 37428 | | 3840 | |

WATTS 740 - Iron body safety relief valves with expanded outlets for hot water space heating boilers. Pressure range 3-75 lbs. with corresponding high ratings from 925,000 to 10,700,000 BTU/hr. A wide range of relieving capacities. Lower BTU per thousand costs because this series provides a much higher BTU rating, size for size, than other valves on the market. Female inlet and outlet connections. 3/4" to 2".

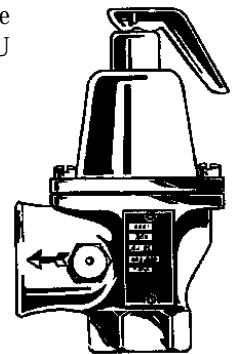

SETTING AND RELIEVING CAPACITIES

Setting and Relieving capacity National Board Certified Rating BTU discharge capacity

| SIZE | 30 LBS | 50 LBS | 75 LBS |
|---------------|-----------|-----------|------------|
| 3/4"x1" | 925,000 | 1,352,000 | 1,886,000 |
| 1"x1 1/4" | 1,300,000 | 1,899,000 | 2,649,000 |
| 1 1/4"x1 1/2" | 2,105,000 | 3,075,000 | 4,285,000 |
| 1 1/2" x 2" | 2,900,000 | 4,237,000 | 5,909,000 |
| 2" x 2 1/2" | 5,250,000 | 7,672,000 | 10,700,000 |

| SIZE | 30 # PSI | | 50 # PSI | | 75 # PSI | | SPECIAL SET | |
|--------|----------|-------|----------|-------|----------|-------|-------------|-------|
| | FIG. NO. | PRICE | FIG. NO. | PRICE | FIG. NO. | PRICE | FIG. NO. | PRICE |
| 3/4 | 37398 | | 37399 | | 37401 | | 3806 | |
| 1" | 37402 | | 37403 | | 37404 | | 3809 | |
| 1 1/4" | 37405 | | 37406 | | 37407 | | 3815 | |
| 1 1/2" | 37408 | | 37409 | | 37410 | | 3817 | |
| 2" | 37411 | | 37412 | | 37413 | | 3822 | |

STEAM AND WATER SAFETY VALVES

KUNKLE 6000 SERIES

MODELS 6010-6021, 6030, 6221, 6230, 6238 FBF-FBA



PRESSURE LIMITS

Steam to 250 PSIG 406oF
Air/Gas to 300 PSIG 300oF
Models 6030, 6130, 6230,
to 300 PSIG steam 422oF
Model 6186 to 150 PSIG
Air/Gas 300oF

APPLICATIONS

Steam boilers and genera-
tors.

Air/Gas compressors - reci-
procating or rotary - portable or stationary,
intercoolers and after coolers.

Pressure Vessels - containing steam, air or non-
hazardous gas. Including tanks, receivers, ster-
ilizers and autoclaves.

KUNKLE 252 SERIES

MODELS 252-253, 254

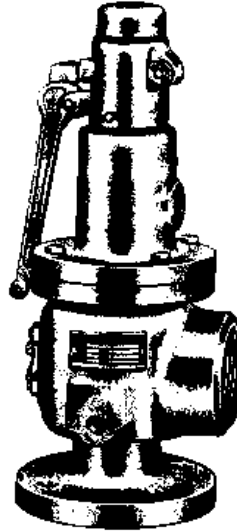

PRESSURE LIMITS

250 PSIG - 406oF

APPLICATIONS

Steam boilers and generators.
Pressure reducing stations
Air/Gas compressors - reciprocating or rotary
Pressure Vessels Including tanks, receivers, Intercoolers, Oil - Gas separators, lines.

**KUNKLE, CONSOLIDATED,
LONERGAN, LUNKENHEIMER, ETC.
CALL TODAY WITH YOUR
SPECIFICATIONS!**

**REBUILD SERVICE
NOW AVAILABLE!**

**BRASS, IRON, STAINLESS, PVC,
DUCTILE...CALL US TODAY!**

**SPECIAL EXPEDITING SERVICE FOR
THOSE HARD TO GET SETTINGS!**

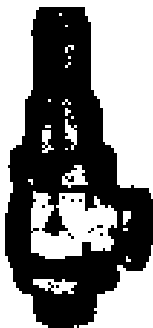

KUNKLE Pop Safety Valve
Liquid 0-300 PSI
3/4" to 4" available.
Call now for your special
pricing!



KUNKLE Pop Safety Valve.
Stainless Steel for corrosive liq-
uid service. Range 0-400 PSI.
1/2" to 2" available.
Call now for your pricing!



KUNKLE Pop Safety Valve.
High pressure liquid, gas &
vapor. Carbon steel, SS trim
Range 0-3300 PSI
Sizes 1/2" to 1" available.
Call now for your special pricing!

AQUA-MIX

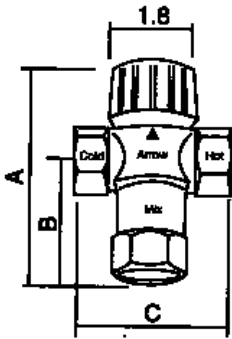

AQUAMIX anti-scald proportional thermostatic mixing and diverting valve. Aquamix offers anti-scald, anti-chill protection and meets the new plumbing codes. Aquamix accurately adjusts, maintains and limits the hot water temperature to a desired setting selected by the user. In domestic applications it makes the use of hot water safe and saves money.

APPLICATIONS Domestic water, space heating, radiant floor heating, hydro heat, combo systems, heat pump systems, solar hot water, nursing homes, greenhouses, public facilities, industrial applications, photo processing.

**GREAT
REPLACEMENT
FOR
WATTS 70A!**

| FIG. NO. | CONNECTION SIZE | FLOW AT 22PSI PRES-SURE DROP | TEMP RANGE | PRICE |
|----------|-----------------|------------------------------|------------|-------|
| 45160 | 1/2" NPT | 8 GPM | 110-145°F | |
| 45162 | 3/4" NPT | 10 GPM | (43-63°C) | |
| 48923 | 1" NPT | 12 GPM | | |
| 48921 | 1/2" NPT | 8 GPM | 90-120°F | |
| 48922 | 3/4" NPT | 10 GPM | (32-49°C) | |
| 48925 | 1" NPT | 12 GPM | | |
| 59768 | 1/2" NPT | 8 GPM | 70-100°F | |
| 59769 | 3/4" NPT | 10 GPM | (21-37°C) | |
| 59770 | 1" NPT | 12 GPM | | |

HEAT-TIMER TEMPERING VALVES

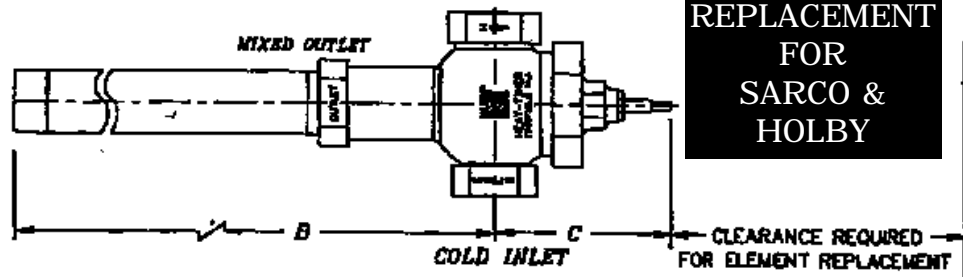
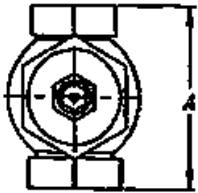

**GREAT
REPLACEMENT
FOR
SARCO &
HOLBY**

SPECIFICATIONS & DIMENSIONS

| VALVE SIZE | A | B | C | CLEARANCE FOR ELEMENT PLACEMENT | NPT PIPE TAP | | | FIG. NO. | PRICE |
|------------|--------|--------|-------|---------------------------------|--------------|-----------|------------|----------|-------|
| | | | | | MIXED OUTLET | HOT INLET | COLD INLET | | |
| 1/2" | 4 1/2 | 8 | 4 1/2 | 7 | 1/2 | 1/2 | 1/2 | 73310 | |
| 3/4" | 4 1/2 | 8 | 4 1/2 | 7 | 3/4 | 3/4 | 3/4 | 73311 | |
| 1" | 4 1/2 | 11 1/4 | 4 1/2 | 12 | 1 | 1 | 1 | 73312 | |
| 1 1/4" | 4 3/4 | 19 | 5 | 19 | 1 1/4 | 1 1/4 | 1 | 73313 | |
| 1 1/2" | 5 1/2 | 23 | 5 | 24 | 1 1/2 | 1 1/2 | 1 1/4 | 73314 | |
| 2" | 6 3/8 | 25 | 6 | 24 | 2 | 2 | 1 1/2 | 73315 | |
| 2 1/2" | 7 1/2 | 27 3/4 | 6 | 28 | 2 1/2 | 2 1/2 | 2 | 73316 | |
| 3" | 9 | 29 1/8 | 6 1/2 | 28 | 3 | 3 | 2 1/2 | 73317 | |
| 4" | 10 1/4 | 31 | 7 | 28 | 4 | 4 | 4 | 73318 | |

THE HEAT-TIMER TEMPERING VALVE IS A PRIMARY TEMPERING VALVE AND IS NOT DESIGNED OR RECOMMENDED TO BE USED AS A "FAILSAFE OR ANTI-SCALD" VALVE

HEAT-TIMER TEMPERING VALVES

PRECISE WATER TEMPERATURE CONTROL FOR:

Hotels, hospitals, other healthcare facilities, schools, apartments, office and industrial buildings, processing plants. Designed with a come-apart internal bore (now called inserts) that can be removed and replaced. This same modular construction also applies to the adjusting screw, bonnet, piston, spring and thermostat element of all heat-timer valves. Heat-timer valves are designed to handle all flows from low to peak automatically.

DOLE STEAM VENTS

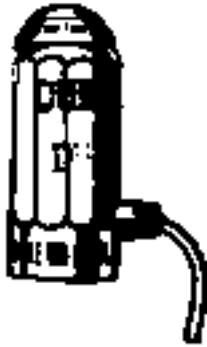

NO 1A VARI-VENT - Adjustable to balance steam distribution. 1/8" angle connection for radiators. Chrome plated.

| FIG. NO. | PRICE |
|----------|-------|
| 8875 | |

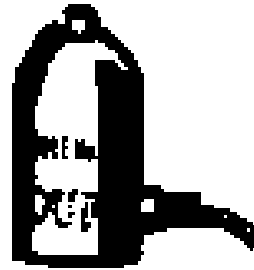

NO 1933 ANGLE VALVE - For radiators, 1/8" connection. Nickel plated.

| FIG. NO. | PRICE |
|----------|-------|
| 8884 | |



NO 1933 1/8" & 1/4" STRAIGHT SHANK AIR VALVES. For convectors, pipe coils, etc. Nickel plated.

| SIZE | FIG. NO. | PRICE |
|------|----------|-------|
| 1/8 | 8887 | |
| 1/4 | 30968 | |



NO. 1933 STRAIGHT SHANK AIR VALVE - For convectors, pipe coils, ect. 3/4" male x 1/2" female. Nickel plated.

| FIG. NO. | PRICE |
|----------|-------|
| 8889 | |



NO. 4 QUICK VENT - For mains, does not close against water. 3/4" male x 1/2" female connection. Chrome plated.

| FIG. NO. | PRICE |
|----------|-------|
| 8879 | |



ECONOMY STEAM AIR VALVE - Good quality, low price.

| | FIG. NO. | PRICE |
|---------------|----------|-------|
| Adjustable | 51106 | |
| Nonadjustable | 41238 | |

WATER VENTS

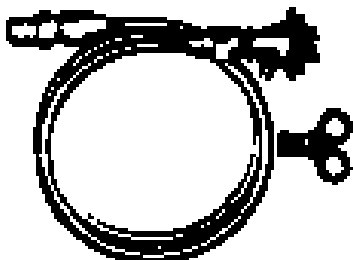

NO. 14 KEY AIR VALVE ASSEMBLY. Tubing length 20". 1/8" NPT connection

| FIG. NO. | PRICE |
|----------|-------|
| 30967 | |



NO. 55 QUICK VENT- For unit heaters. Max pressure 35 lbs. 3/4" male x 1/2" female connection. chrome plated.

| FIG. NO. | PRICE |
|----------|-------|
| 8882 | |



LOOSE KEY

One piece brass body, precision milled insert, full port, perfect threads.

| FIG. NO. | PRICE |
|----------|-------|
| 17683 | |



Coin function, key function.

| FIG. NO. | PRICE |
|----------|-------|
| 17684 | |

HOFFMAN AIR VALVE



NO. 1-A AIR VALVE
- A float-type vent with adjustable port for true proportional venting. Port settings from (#1)

slow to (#6) fast venting. Operating pressure up to 1 1/2 PSI. Max pressure: 10 PSI

| FIG. NO. | PRICE |
|----------|-------|
| 7619 | |



NO 76 AIR VENT FOR VACUUM STEAM SYSTEM

- Float-type vents, each with single non-adjustable port for relieving air from the mains of medium and large size one-pipe vacuum systems. 1/2" female x

3/4" male straight shank. Operating pressure up to 3 PSI

| FIG. NO. | PRICE |
|----------|-------|
| 38697 | |



NO. 78 WATER MAIN VENT VALVE

- Designed for use on high pressure hot or cold water mains and process applications. Cast brass body. Safety drain connection for discharging moisture entrained in the vented air. Tapped at top for

1/8" IPS built-in check valve. 3/4". 150 PSI will withstand hydrostatic pressures of 450 PSI

| FIG. NO. | PRICE |
|----------|-------|
| 7624 | |



NO. 75 MAIN STEAM VENT

- Float type vents, each with single non-adjustable port for relieving air from the mains of medium and large size systems.

| FIG. NO. | PRICE |
|----------|-------|
| 7623 | |



NO. 40 STEAM-AIR VALVE - A float-type vent with a single non-adjustable port. For use on ordinary one-pipe system not requiring proportional venting. 1/8" angle.

| FIG. NO. | PRICE |
|----------|-------|
| 7620 | |



NO. 74 STEAM UNIT HEATER AIR VALVE

- Float-type vent with single non-adjustable port especially designed for use with steam unit heaters. Vents air, when present, with rising, dropping or steady pressure. Operating pressure up to 35 PSI. 3/4"

| FIG. NO. | PRICE |
|----------|-------|
| 7628 | |



NO. 79 WATER MAIN VENT VALVE

- Designed for use on hot or cold water mains and process applications. Tapped at top for 1/8" IPS safety drain connection for discharging moisture entrained in the vented

air. Built in check valve. 1/2" F x 3/4" M. Max Oper pressure: 75 PSI will withstand hydrostatic pressures of 200 PSI

| FIG. NO. | PRICE |
|----------|-------|
| 7625 | |

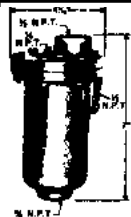

NO. 792 HIGH PRESSURE WATER VENT - Designed for releasing air from hot or cold water mains, hydronic heating and chilling systems storage and processing tanks filters, centrifugal pumps. Cast iron body and cover, stainless steel interior.



NO. 500 STEAM OR WATER AIR VALVE - For convectors and radiators, a disc-type vent, with built-in check valve, for automatic venting. Can be taken apart for cleaning without removing from line. 1/8"

straight shank. Max steam pressure 15 PSI.

| FIG. NO. | PRICE |
|----------|-------|
| 41940 | |



NO. 4 QUICK STEAM VALVE

- Thermostatic air vent for steam systems and process equipment. Operates on temperature changes only: does not close against water. Quick vent must be installed on a nipple 6" to 10" above horizontal return, which must be at least 18" above the boiler water. 1/2" F x 3/4" M. Max Opera. Press: 25 PSI

| FIG. NO. | PRICE |
|----------|-------|
| 7627 | |



NO. 62 STEAM VACUUM BREAKER

- Designed for use on closed vessels and piping systems to control induced vacuum within safe limits. Factory set to open at 2" (mercury) vacuum. Adjustable from 1/4" to 20" (mercury) vacuum. 3/4" IPS straight shank. 150 PSI.

| FIG. NO. | PRICE |
|----------|-------|
| 7629 | |

| FIG. NO. | PRICE |
|----------|-------|
| 7630 | |



No. 7
for vertical mounting 4
3/8" x 2 1/4" with
1/8" IP female connec-
tion. **For water.**

| FIG. NO. | PRICE |
|----------|-------|
| 17687 | |



AIR VENTS
AUTO VENT #67
for vertical mounting 3
3/16" x 1 1/2", with
1/4 IPT male connection.
For water.

| MODEL | FIG. NO. | PRICE |
|-------|----------|-------|
| 67 | 17686 | |
| 68 | 49276 | |

SHORT STOP

with a short stop valve installed in a Maid-O-Mist (#67) air vent, **water** can flow around the extended valve mechanism into the vent. When the air vent is removed from the line, the mechanism automatically retracts to shut off the flow of water.

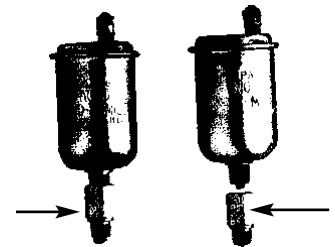

| FIG. NO. | PRICE |
|----------|-------|
| 49275 | |

INDUSTRIAL AIR VENT



Built-in shutoff.
Includes vent cap and
leakage guard. 3/4"
male x 1/2" female.
For **hydronic** heating
and cooling applica-
tions.

| FIG. NO. | PRICE |
|----------|-------|
| 48875 | |

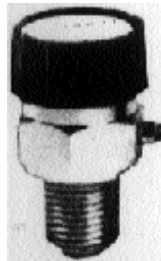

HYDROVENT

Automatic air vent for hot
water and steam systems.
Install in baseboards, radiators,
convectors and high points in
piping systems to remove air.
The nickel plated valve has a
quick venting design and a posi-
tive shut-off ball check. The hydrovent features a
replaceable cartridge with hygroscopic discs. The
cartridges can be replaced without shutting off the
system.

| FIG. NO. | PRICE |
|----------|-------|
| 41940 | |



AUTO VENT
Built-in shutoff. 1/8" NPT male.
EPDM seat disc and O-ring. For
hydronic heating/cooling applications.
**DO NOT use in systems with oil or
petroleum based additives.**

| FIG. NO. | PRICE |
|----------|-------|
| 34297 | |



Fast Venting Air Valve for Steam.
"C". Gorton Vapor Equalizing Valve.
Venting capacity equal to 15 ordinary
type air valves on radiators far-
thest from the boiler and in
coldest rooms; For example,
on third-floor radiators and
above.
"D". Gorton Vapor
Equalizing Valve. Venting
capacity equal to 27 ordinary
type air valves in cases where a
large amount of air must be vented; for
example, on radiators having particularly long branches and on
very large radiators. Not to be used on hand-fired systems
unless radiator supply valves are left "on" all the time.

| DESCR | FIG. NO. | PRICE |
|-------|----------|-------|
| C | 45443 | |
| D | 45444 | |

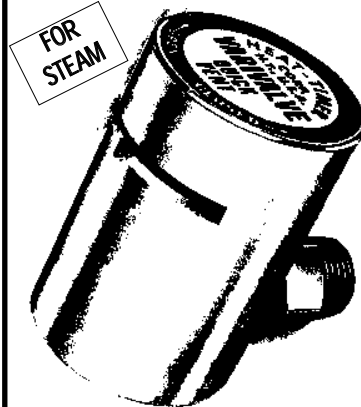

FOR STEAM

VARIVALVE - Adjustable
at each location; Each radiat-
or vented as required...
With just ounces of pres-
sure VariValves can be
adjusted to make radiators
heat up faster.
*Exclusive fingertip adjust-
ment. The venting orifice
can be adjusted by a simple
sliding lever to provide
fastest venting in hard-to-
heat areas, or reduced vent-
ing in overheated areas.
*Give each radiator its own venting speed. No longer is
there any need to build pressure to reach remote areas -
meanwhile overheating the rest of the space.
*Cost competitive with ordinary air valves. Considering the
extra value, the VariValve is quite inexpensive only slightly
more than ordinary non-adjustable valves.

| DESCRIPTION | FIG. NO. | PRICE |
|-------------|----------|-------|
| Angle | 38919 | |
| Straight | 38918 | |

ADJUSTABLE INDUSTRIAL THERMOMETER



*9" Case
*3 1/2" stem
*30-240°
OTHER RANGES AVAILABLE
s-40-160, -10-180, 0-160, 30-300, 50-550



SOLAR DIGITAL

| FIG. NO. | PRICE | FIG. NO. | PRICE |
|----------|-------|----------|-------|
| 16491 | | 85098 | |

BRASS WELL



3/4"

| FIG. NO. | PRICE |
|----------|-------|
| 16501 | |

STRAP ON THERMOMETER



| FIG. NO. | PRICE |
|----------|-------|
| 47352 | |

CALL DUFF FOR ALL YOUR GAUGE APPLICATIONS!

THERMOMETERS

ANGLE HOT WATER THERMOMETER



With iron well.

| FIG. NO. | PRICE |
|----------|-------|
| 16470 | |

With brass well.

| FIG. NO. | PRICE |
|----------|-------|
| 16473 | |

DIAL THERMOMETER

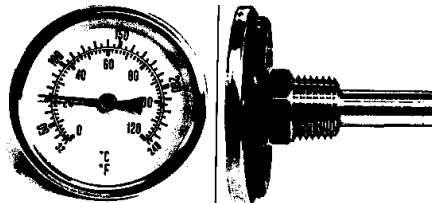

1/2" Male brass well. 30°-250°F 1-3/4" stem

| FIG. NO. | PRICE |
|----------|-------|
| 44471 | |

POCKET THERMOMETER

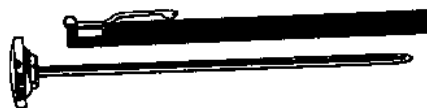

Plastic water tight dial cover
Stainless steel construction
Recalibration nut

| RANGE | FIG. NO. | PRICE |
|---------|----------|-------|
| 0+220 | 8868 | |
| -40+160 | 63942 | |

STRAIGHT HOT WATER THERMOMETER

With iron well.



| FIG. NO. | PRICE |
|----------|-------|
| 16471 | |

With brass well.

| FIG. NO. | PRICE |
|----------|-------|
| 16483 | |

HYDRO THERMOMETERS

Boiler gauge - Trindicator
68°F-250°F, 0-60", 0-130 ft H₂O



| MOUNT | FIG. NO. | PRICE |
|-------------|----------|-------|
| 2 1/2 Back | 16903 | |
| 3 1/2 Back | 16921 | |
| 3 1/2 Lower | 16925 | |

DIAL THERMOMETERS

VAPOR ACTUATED

4 1/2" ADJUSTABLE ANGLE

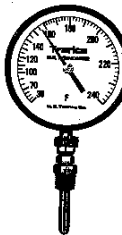

CASE: Cast aluminum - black finished
RING: close type -stainless steel
WINDOW: Glass

DIAL: White background with black embossed figures
POINTER: Adjustable - Stainless Steel - black finish
MOVEMENT: Brass - bronze bearings
BOURDON TUBE: Phosphor bronze
CONNECTION: 1/2" brass union connection and copper bulb. For separable sockets see price sheet
ACCURACY: Within one scale division

30 to 240°F

| FIG. NO. | PRICE |
|----------|-------|
| 80759 | |

DIGITAL POCKET TEMPERATURE INDICATOR

DESCRIPTION:

The KWIK THERM is a digital temp indicator that has a swiveling head which makes it easy to read at any angle. The swivel head allows it to be placed flat in your pocket. Updates every 15 seconds.

SPECIFICATIONS: Model #PAD-300, range -50/300°F, 1%, 1% accuracy, 5" length.

| FIG. NO. | PRICE |
|----------|-------|
| 47581 | |



MINITHERM COMPACT DIGITAL THERMOMETER



| WITH 3' SENSOR LEAD | |
|---------------------|-------|
| FIG. NO. | PRICE |
| 47583 | |



| SELF-CONTAINED | |
|----------------|-------|
| FIG. NO. | PRICE |
| 48973 | |

Super Heat
The mini-THERM costs 10 times less than other super heat temperature indicators.



The mini-therm is a compact digital temperature indicator that weighs only 10 grams and is a mere 2 1/4" wide. The mini-therm is so versatile that it can be used to measure the temperature of everything from Super Heat to Refrigerant Recovery to outside air temperature.

WATER GAUGE SET

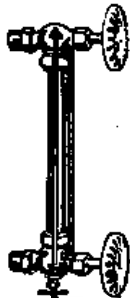

1/2 MIP X 5/8 OD Glass

| FIG. NO. | PRICE |
|----------|-------|
| 16938 | |

HEAVY DUTY INDUSTRIAL WATER GAUGE SET



For Industrial and Commercial use

| DESCR | FIG. NO. | PRICE |
|------------------|----------|-------|
| 1/2 MIP X 5/8 OD | 34342 | |
| 3/4 MIP X 3/4 OD | 37546 | |

ALL WATER GAUGE SETS ARE AVAILABLE IN STAINLESS STEEL!

PIG TAIL SYPHONS

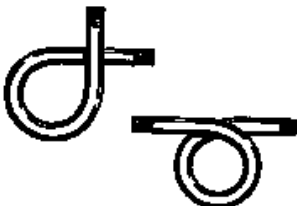

| 1/4" BLACK | |
|------------|-------|
| Angle | 17048 |
| Straight | 17044 |
| 1/4" BRASS | |
| Angle | 17060 |
| Straight | 17056 |

**WATER GAUGE SETS
REGULAR GAUGE GLASS**

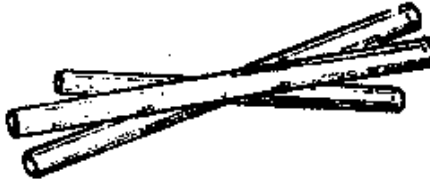

| SIZE | FIG. NO. | PRICE |
|-------------|----------|-------|
| 5/8 OD X 12 | 16941 | |
| 5/8 OD X 18 | 49663 | |
| 5/8 OD X 24 | 16949 | |
| 5/8 OD X 36 | 16952 | |
| 5/8 OD X 48 | 45178 | |
| 3/4 OD X 12 | 16989 | |
| 3/4 OD X 24 | 16995 | |
| 3/4 OD X 36 | 16999 | |

RED LINE GLASS

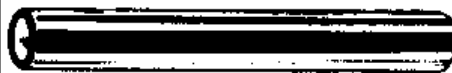

Extra hard for shock
Corrosive resistant

Heat resisting to temperature change
boiler water gauges and other liquid level gauges

| DESCR | FIG. NO. | PRICE |
|-------------|----------|-------|
| 5/8 OD X 12 | 16956 | |
| 5/8 OD X 24 | 16958 | |
| 5/8 OD X 36 | 16973 | |
| 5/8 OD X 48 | 50593 | |
| 3/4 OD X 12 | 17000 | |
| 3/4 OD X 24 | 17002 | |
| 3/4 OD X 36 | 17006 | |
| 1/2 OD X 12 | 17014 | |
| 1/2 OD X 24 | 17017 | |
| 1/2 OD X 36 | 17023 | |

GAUGE GLASS BRUSH



FOR 5/8 OD GAUGE GLASS

| LENGTH | FIG. NO. | PRICE |
|--------|----------|-------|
| 8" | 45184 | |
| 30" | 63946 | |

GAUGE GLASS WASHERS



| DESCR | FIG. NO. | PRICE |
|---------------|----------|-------|
| 1/2 OD | 17034 | |
| 5/8 OD | 17040 | |
| 5/8 OD Teflon | 50848 | |
| 3/4 OD | 17028 | |

GAUGE GLASS NUTS



Brass gauge glass coupling nuts 5/8 OD

| SIZE | FIG. NO. | PRICE |
|------|----------|-------|
| 5/8" | 48884 | |
| 3/4" | 48885 | |

FRICTION RING



Gauge glass friction ring 5/8 OD

| FIG. NO. | PRICE |
|----------|-------|
| 48882 | |

TRI-COCK



| SIZE | FIG. NO. | PRICE |
|------|----------|-------|
| 3/8 | 8446 | |
| 1/2 | 8448 | |

OBSERVATION PORTS



3/8" NPT TO 1 1/2" NPT AVAILABLE. CALL FOR PRICING!

WATER GAUGE SETS

AUTOMATIC DUCTILE IRON OR STAINLESS STEEL GAUGE

For steam 250 pounds at 450o F.

Liquid level up to 500 pounds

Subject to limitations of gauge glass
Material used conforms with or exceeds requirements of AISA, ASTM and/or API-ASME for maximum recommended pressures and temperatures.

Specify for steam or liquid level as automatic balls must be removed for steam.



Ruber washer for:

5/8" glass 9/12x13/16x3/8

3/4" glass 11/16x15/16x3/8

Rods 1-1/4" shorther than centers.

Glass 2" shorther than centers.

| MODEL NO. | TYPE OF GAUGE | CONN. SIZE | GLASS O.D. |
|------------|-----------------|------------|------------|
| DEEP70A316 | Stainless Steel | 1/2" | 5/8" |
| DEEP71A316 | Stainless Steel | 3/4" | 3/4" |
| DEEP70A | Iron | 1/2" | 5/8" |
| DEEP71A | Iron | 3/4" | 3/4" |

PVC GAUGE POLYVINYL CHLORIDE

NON-AUTOMATIC OR AUTOMATIC
HAND WHEEL SHUT OFF FOR PRESSURE UP TO
125 POUNDS AT 75oF

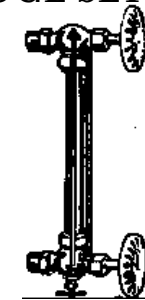

All parts coming in contact with liquid made of Polyvinyl Chloride (PVC) has greater resistance to corrosive environments and solutions than many other materials. This gauge can be used in place of stainless steel and monel. Supplied with Teflon packings.

To determine length of glass: Rods 1-3/8"
Glass 2" shorther than centers: shorther than centers

| MODEL NO. | CONN. SIZE | GLASS O.D. |
|-----------|------------|------------|
| DEEP-PVC | 1/2" | 3/4" |
| DEEP-PVC | 3/4" | 3/4" |

BRONZE GAUGE CHAIN LEVER SQUARE BODY automatic

For steam pressures up to 300 PSI



Ruber washer for:

5/8" glass 9/16"x13/16"x3/8"

3/4" glass 11/16"x15/16"x3/8"

Rods 1-1/4" shorther than centers.

Glass 2" shorther than centers.

3/8" drain cock.

| FIG. NO. | NPT CONN | GLASS OD | STYLE | PRICE |
|----------|----------|----------|-------|-------|
| DEEP31AL | 1/2" | 5/8" | 5-35 | |
| DEEP34AL | 3/4" | 3/4" | 5-35 | |

SAFETY BOILER

HIGH AND LOW ALARM

250 POUND

10" GAUGE CENTERS

STEAM & WATER CONNECTION

1-1/4"

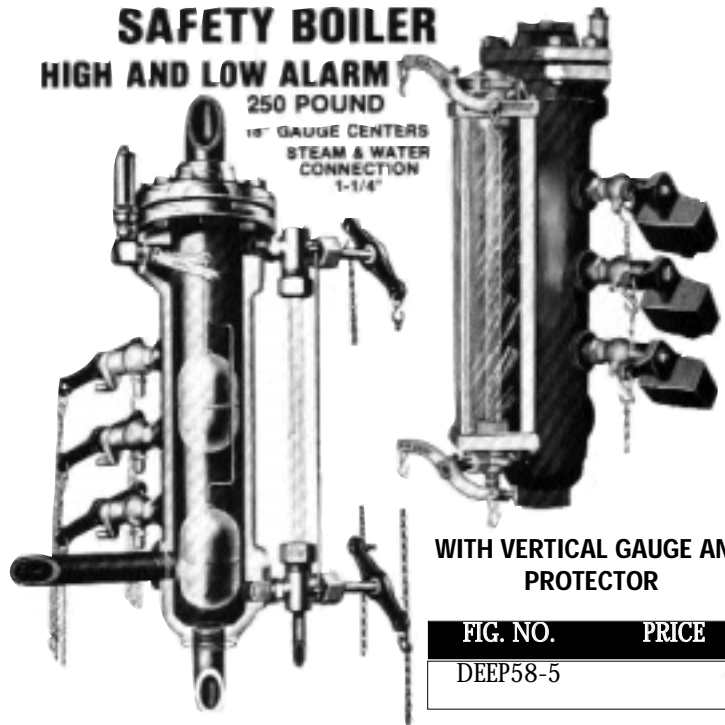

WITH VERTICAL GAUGE AND PROTECTOR

| FIG. NO. | PRICE |
|----------|-------|
| DEEP58-5 | |

WITH VERTICAL GAUGE

| FIG. NO. | PRICE |
|------------|-------|
| DEEP58-5-2 | |

WATER GAUGE SETS

**V-SHAPE SAFETY EYE
GAUGE GLASS PROTECTOR**

PLEXIGLAS OR WIRE GLASS

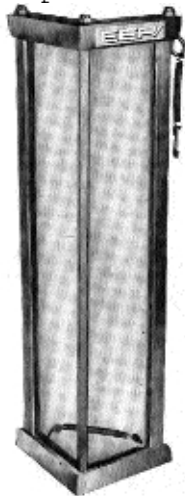

PLEXIGLAS
MODEL NO.
EEP 31-508

**DON'T WAIT FOR ACCIDENTS
TO HAPPEN MADE TO
FIT ALL WATER GAUGES
AND LIQUID LEVEL GAUGES
IN ANY LENGTH SPECIFIED**

**When ordering to insure
Proper Fit Specify**

**A - Distance
Between
Thread
Ends**

**B - Distance
(outside)**

**Nuts made
up on
your
gauges**

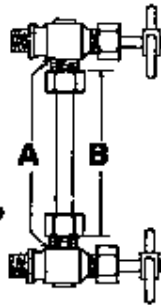

WIRE GLASS
MODEL NO.
EEP 9-508

GAUGE GLASS CUTTER

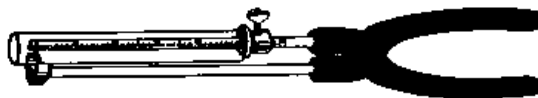

Standard Gauge Glass Cutter with Carbide Wheel for Round Tubular Gauge Glasses.

| FIG. NO. | PRICE |
|----------|-------|
| 17470 | |

**SQUEEZE & POP
GLASS CUTTER**



Cuts cast iron, tile and asbestos cement pipe in seconds with no turning.

Cutter chain is wrapped around tubing right at the point where cut is to be made. Any length from 1/2: to several feet may be cut. Cuts up to 3/4" OD.

| FIG. NO. | PRICE |
|----------|-------|
| 17473 | |

For additional information call: 610-275-4453 or Fax: 610-279-6299
Please call for current prices.

PINCH AND CUT GLASS CUTTER



Forged Bronze. For cutting by the rotation of a hardened steel wheel about the outside of a tube of any size not larger than 1-1/8". It employs two V guides to align the tubing at a position normal to the cut. The wheel is held normally open by a coil spring.

| FIG. NO. | PRICE |
|----------|-------|
| 49662 | |

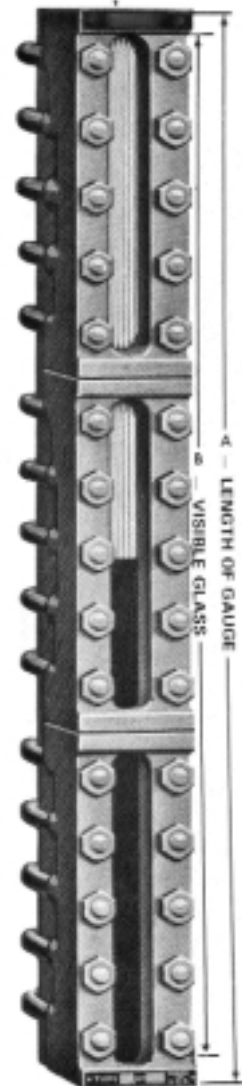

**STEEL GAUGE VALVES
CALL FOR PRICE AND
AVAILABILITY**

GAUGES



| 1 1/2" FACE | | | |
|-------------|-------|------------|-----------------|
| LOWER MOUNT | | BACK MOUNT | |
| RANGE | MOUNT | FIG. NO. | PRICE |
| 0-15 | 1/4 | 36522 | |
| 0-60 | 1/8 | 16503 | |
| 0-100 | 1/8 | 16507 | |
| 0-160 | 1/8 | 16512 | 0-160 1/8 16515 |
| 0-300 | 1/8 | 33867 | |
| 2" FACE | | | |
| 0-15 | 1/4 | 16519 | 0-15 1/4 16582 |
| 0-30 | 1/8 | 36523 | 0-30 1/8 36528 |
| 0-30 | 1/4 | 16532 | 0-30 1/4 16583 |
| 0-60 | 1/4 | 16533 | 0-60 1/8 20250 |
| 0-60 | 1/8 | 16566 | 0-60 1/4 16586 |
| 0-100 | 1/4 | 16537 | 0-100 1/8 16574 |
| 0-160 | 1/4 | 16541 | 0-100 1/4 16590 |
| 0-160 | 1/8 | 16570 | 0-160 1/8 16578 |
| 0-200 | 1/4 | 16544 | 0-160 1/4 18369 |
| 0-300 | 1/4 | 16550 | 0-200 1/4 47156 |
| 0-300 | 1/8 | 16572 | 1/4 |
| 0-400 | 1/4 | 16553 | 1/4 |
| 0-600 | 1/4 | 16557 | 1/4 |
| 0-1000 | 1/4 | 16561 | 1/4 |
| 0-4000 | 1/4 | 52379 | 1/4 |
| 2 1/2" FACE | | | |
| 0-5 | 1/4 | 48434 | 1/4 |
| 0-15 | 1/4 | 16592 | 0-15 1/4 17727 |
| 0-30 | 1/4 | 16594 | 0-30 1/4 47158 |
| 0-30 | 1/8 | 36524 | 1/4 |
| 0-60 | 1/4 | 16596 | 0-60 1/4 16641 |
| 0-60 | 1/8 | 36525 | 1/4 |
| 0-100 | 1/4 | 16604 | 0-100 1/4 16646 |
| 0-100 | 1/8 | 36527 | 1/4 |
| 0-160 | 1/4 | 16607 | 0-160 1/4 16649 |
| 0-200 | 1/4 | 16610 | 0-200 1/4 47157 |
| 0-300 | 1/4 | 16613 | 0-300 1/4 52380 |
| 0-400 | 1/4 | 16617 | 0-400 1/4 47155 |
| 0-600 | 1/4 | 16621 | 1/4 |
| 0-1000 | 1/4 | 16625 | |
| 0-2000 | 1/4 | 16628 | |
| 0-3000 | 1/4 | 16633 | |
| 0-5000 | 1/4 | 16637 | |

GAUGE GUARD



Protects gauges and other instruments from corroding. They also prevent gauges from contaminating sensitive fluids. The viton membrane isolates the gauge from the process medium, while still maintaining a highly accurate instrumental reading. Ideal for use in instrumentation systems, or with valves requiring a pressure or vacuum gauge.

1/4"

| FIG. NO. | PRICE |
|----------|-------|
| 42449 | |

| 3 1/2" FACE | |
|-------------|-------|
| LOWER MOUNT | |
| RANGE | MOUNT |
| 0-15 | 1/4 |
| 0-30 | 1/4 |
| 0-60 | 1/4 |
| 0-100 | 1/4 |
| 0-160 | 1/4 |
| 0-200 | 1/4 |
| 0-300 | 1/4 |
| 0-400 | 1/4 |
| 0-600 | 1/4 |
| 0-1000 | 1/4 |
| 0-2000 | 1/4 |
| 0-5000 | |

| 4 1/2" FACE | | |
|-------------|-----|-------|
| 0-15 | 1/4 | 16740 |
| 0-30 | 1/4 | 16757 |
| 0-60 | 1/4 | 16763 |
| 0-100 | 1/4 | 16769 |
| 0-160 | 1/4 | 16774 |
| 0-200 | 1/4 | 16782 |
| 0-300 | 1/4 | 16786 |
| 0-400 | 1/4 | 16795 |
| 0-600 | 1/4 | 16802 |
| 0-1000 | 1/4 | 16810 |
| 6" FACE | | |
| 0-15 | 1/4 | 16816 |
| 0-30 | 1/4 | 16821 |
| 0-60 | 1/4 | 16828 |
| 0-100 | 1/4 | 16841 |
| 0-160 | 1/4 | 16843 |
| 0-200 | 1/4 | 16849 |

PANEL MOUNT GAUGES



FIG. NO. PRICE

BRASS PRESSURE SNUBBER



1/4" NPT porous core.

| FIG. NO. | PRICE |
|----------|-------|
| 16935 | |

FIG. NO. PRICE

STAINLESS PRESSURE GAUGE

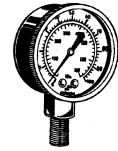

1/4" LOWER MOUNT
2 1/2" FACE

| | |
|-------------|-------|
| 100 LB | 36529 |
| 160 LB | 36530 |
| 100 LB | 45439 |
| Liquid fill | |

LIQUID FILL PRESSURE GAUGE



1/4" LOWER MOUNT
2 1/2" FACE

| | |
|--------|-------|
| 100 LB | 51680 |
| 160 LB | 47551 |

COMPOUND GAUGE VACUUM AND PRESSURE 30/30



1/4" LOWER MOUNT

| FACE | FIG. NO. | PRICE |
|-------|----------|-------|
| 2 | 16880 | |
| 2 1/2 | 16891 | |
| 3 1/2 | 16897 | |

VACUUM GAUGE 30 HG!



1/4" LOWER MOUNT

| FACE | FIG. NO. | PRICE |
|-------|----------|-------|
| 2 | 16854 | |
| 2 1/2 | 16862 | |
| 3 1/2 | 16868 | |

MCDONNELL MILLER REPLACEMENT PARTS
REPLACEMENT PARTS

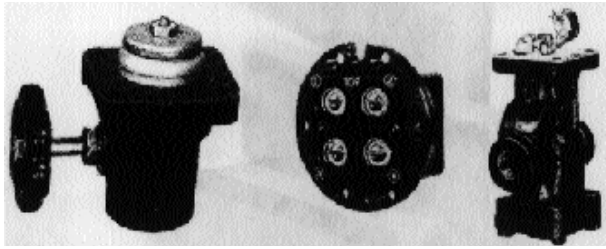

No. 14 Blow Off Valve for 67 series and No's 47, 47-2, 467B, 767. Shipping wt. 2 lbs.

| FIG. NO. | PRICE |
|----------|-------|
| 8950 | |

No. 11 Switch for 67, 69 and 70 series, No's 61, 467 and 767. For 110V or 230V service. Shipping Wt. 1 lb.

| FIG. NO. | PRICE |
|----------|-------|
| 8949 | |

No. SA 47-101-102 Valve and strainer assembly for No's 47 and 247. Shipping Wt. 4 lbs.

| FIG. NO. | PRICE |
|----------|-------|
| 8988 | |

No. SA 51-101-102 Same as above, but for No. 51.

| FIG. NO. | PRICE |
|----------|-------|
| 8995 | |



No. 2 CUT-OFF AND ALARM SWITCH (model #2)

Used to add electrical low water cut-off to mechanical boiler water feeder. Supplied as part of the feeder cut-off combinations or can be purchased separately and added

in brief time. Has high voltage terminals for low water cut-off, and for low water alarm.

ELECTRICAL RATINGS
(underwriters Listed)

Ampere Rating: 115V. DC .5 Amps

| | 115 VAC | 230 VAC |
|--------------|---------|---------|
| Motor duty | 10.2 | 5.1 |
| Full load | 61.2 | 30.6 |
| Locked Rotor | | |

| FIG. NO. | PRICE |
|----------|-------|
| 8858 | |

STRAINER BASKET ASSEMBLY

BRASS COMPRESSION NUT



MP-296
BRASS COMPRESSION NUT
Catalog #: 66-133
Part #: 318700
Used in: 67

| FIG. NO. | PRICE |
|----------|-------|
| 41424 | |

MP-290
STRAINER BASKET ASSEMBLY
FOR MCDONNELL & MILLER
Boxed with M-38 Gasket and
4 Bolts
Cat. #: SA101-38
Part #: 347100
Used in: 47, 51, 101

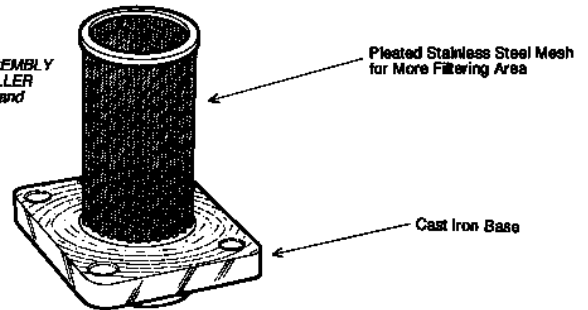

| FIG. NO. | PRICE |
|----------|-------|
| 8997 | |

DUFF ACCEPTS

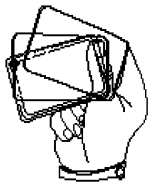

VISA
AND
MASTERCARD!

BRASS TUBE

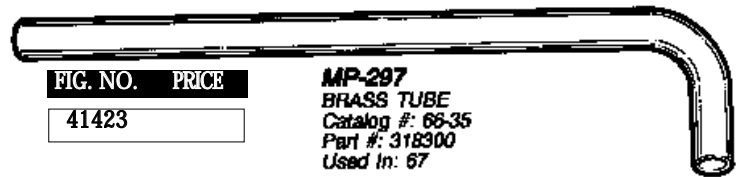

| FIG. NO. | PRICE |
|----------|-------|
| 41423 | |

MP-297
BRASS TUBE
Catalog #: 66-35
Part #: 318300
Used in: 67

MCDONNELL MILLER REPLACEMENT PARTS

DUFF HAS A VERY LARGE INVENTORY
OF ORIGINAL EQUIPMENT PARTS
IN STOCK AND READY FOR IMMEDIATE SHIPMENT!

MCDONNELL & MILLER



Feeder cut-off combination for closed heating system steam boilers up to 5000 sf. **Model 47-2.**

| FIG. NO. | PRICE |
|----------|-------|
| 8840 | |



Make-up water feeder, for boiler receiver tanks, direct mounting eliminates need for equalizing connections. **Model 21.**

| FIG. NO. | PRICE |
|----------|-------|
| 20050 | |



Feeder cut-off combination - larger feeding capacity than #8840. For steam and hot water boilers. **Model 51-2.**

| FIG. NO. | PRICE |
|----------|-------|
| 8850 | |



Make-up water feeder, for low pressure steam boilers, float operated, integral strainer monel seat, maximum water supply pressure 100psig maximum boiler pressure 25 psig. **Model 25A.**

| FIG. NO. | PRICE |
|----------|-------|
| 8856 | |



Feeder cut-off combination for higher pressure service, up to 75 lbs. for steam and hot water. **Model 53-2.**

| FIG. NO. | PRICE |
|----------|-------|
| 25697 | |



Low water fuel cut-off for low pressure steam boilers. For "quick Hook-up" in gauge glass tappings. **Model 67.**

| FIG. NO. | PRICE |
|----------|-------|
| 8872 | |



Low water fuel cut-off for 1" equalizing pipe installation on low pressure steam boilers. **Model 61.**

| FIG. NO. | PRICE |
|----------|-------|
| 8878 | |



Test-N-Check valves for hot water boilers simplifies ASME, CSD 1-a codes mandated testing of low water cut offs by eliminating the need to drain boiler. **Model TC-4.**

| FIG. NO. | PRICE |
|----------|-------|
| 8930 | |



Low water fuel cut-off for hot water space heating boilers up to 50 lbs. pressure. **Model 63.**

| FIG. NO. | PRICE |
|----------|-------|
| 8918 | |



Low water fuel cut-off for installation in 2 1/2" tapping provided on some hot water boilers. **Model 764.**

| FIG. NO. | PRICE |
|----------|-------|
| 22176 | |



Pump control, cut-off and alarm for boilers of any size up to 150 psi. **Model 150-S.**

| FIG. NO. | PRICE |
|----------|-------|
| 63833 | |



Pump control, cut-off and alarm - like #8909 but with integral water column type body. **Model 157-S.**

| FIG. NO. | PRICE |
|----------|-------|
| 63835 | |



Probe type low water cut off. Modern electronic circuitry to sense the level of a conductive liquid within a vessel. **Model PS-801-U-120V.**

| FIG. NO. | PRICE |
|----------|-------|
| 44767 | |



Uni-match electronic flow controlled fueler. **Model WF-2U-120V.**

| FIG. NO. | PRICE |
|----------|-------|
| 44477 | |



Electronic water feeder for systems up to 5000 sq ft cap. **Model 101A-120V.**

| FIG. NO. | PRICE |
|----------|-------|
| 8852 | |

FLOW SWITCHES



NEMA 4X rated flow switch for general purpose applications with environmental exposure, or those requiring a water tight, dust tight enclosure. **Model FS8W.**

| FIG. NO. | PRICE |
|----------|-------|
| 19553 | |



Flow switch for heavy duty service. Brass or stainless steel construction. Explosion proof and vandal-proof models. Pressure to 1000 psi. **Model FS7-4.**

| FIG. NO. | PRICE |
|----------|-------|
| 35671 | |



Flow switch combines low-flow responses with large flow-through capacity. Max pressure, 100 psi. **Model F-S-1.**

| FIG. NO. | PRICE |
|----------|-------|
| 8931 | |

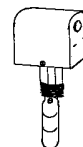

Liquid Flow Switch. **Model FS4-3.**

| FIG. NO. | PRICE |
|----------|-------|
| 8932 | |



Air flow switches for low air velocity systems. **Model AF-2.**

| FIG. NO. | PRICE |
|----------|-------|
| 41421 | |

**CALL DUFF FIRST FOR ALL YOUR
MCDONNELL MILLER
REQUIREMENTS!**

MCDONNELL MILLER REPLACEMENT GASKETS

NOT SHOWN ACTUAL SIZE

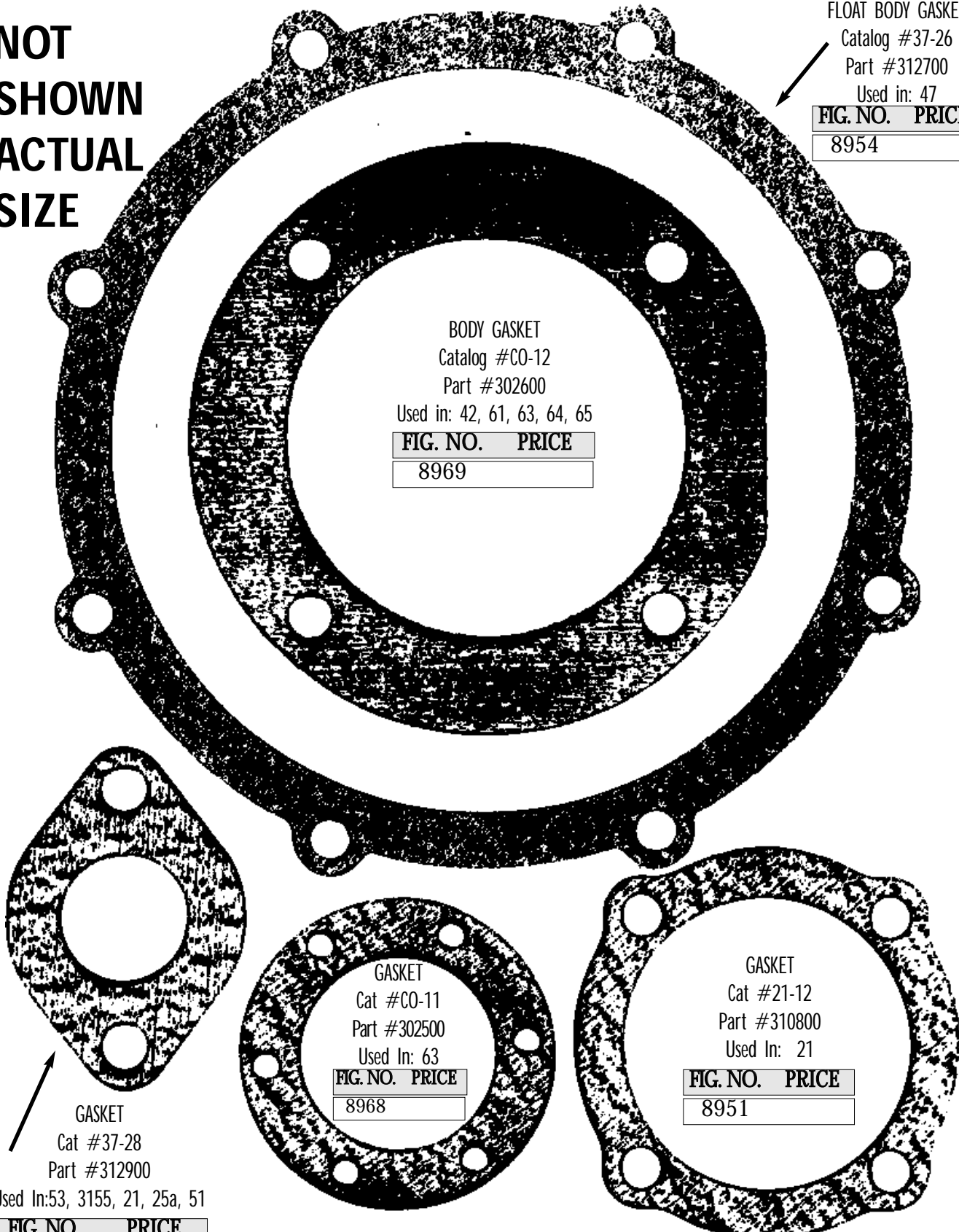

FLOAT BODY GASKET
 Catalog #37-26
 Part #312700
 Used in: 47

| FIG. NO. | PRICE |
|----------|-------|
| 8954 | |

BODY GASKET
 Catalog #CO-12
 Part #302600
 Used in: 42, 61, 63, 64, 65

| FIG. NO. | PRICE |
|----------|-------|
| 8969 | |

GASKET
 Cat #37-28
 Part #312900
 Used In: 53, 3155, 21, 25a, 51

| FIG. NO. | PRICE |
|----------|-------|
| 8957 | |

GASKET
 Cat #CO-11
 Part #302500
 Used In: 63

| FIG. NO. | PRICE |
|----------|-------|
| 8968 | |

GASKET
 Cat #21-12
 Part #310800
 Used In: 21

| FIG. NO. | PRICE |
|----------|-------|
| 8951 | |

MCDONNELL MILLER REPLACEMENT GASKETS

NOT
SHOWN
ACTUAL
SIZE

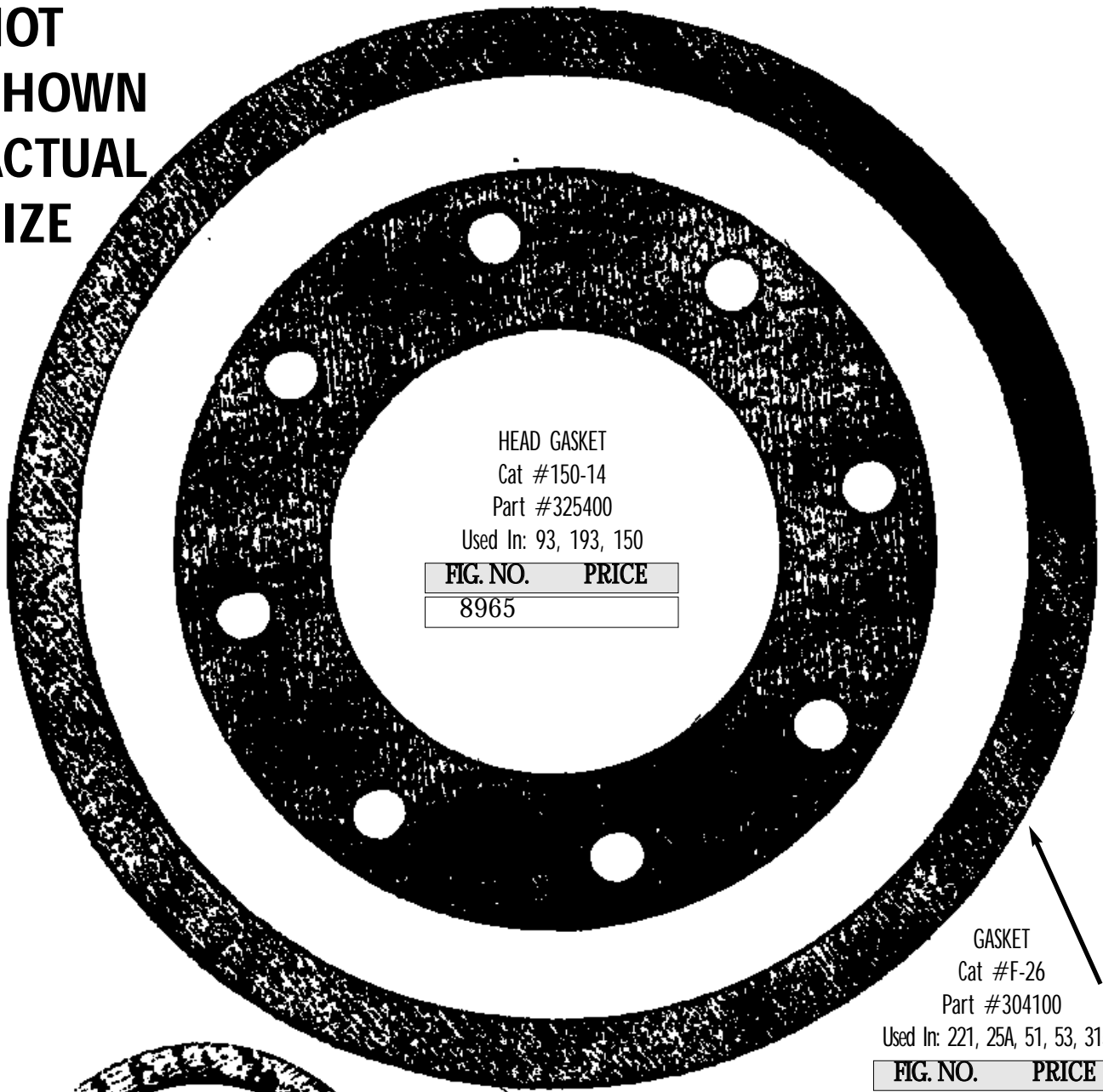

HEAD GASKET
Cat #150-14
Part #325400
Used In: 93, 193, 150

| FIG. NO. | PRICE |
|----------|-------|
| 8965 | |

GASKET
Cat #F-26
Part #304100
Used In: 221, 25A, 51, 53, 3155

| FIG. NO. | PRICE |
|----------|-------|
| 8971 | |

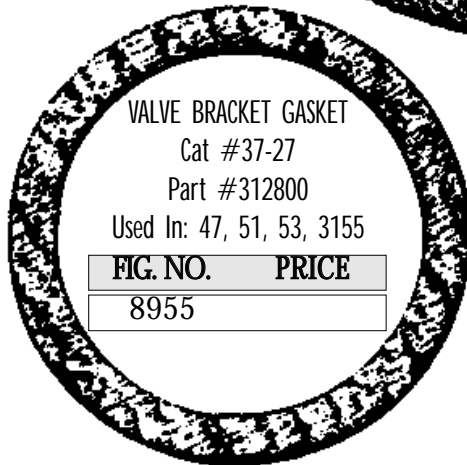

VALVE BRACKET GASKET
Cat #37-27
Part #312800
Used In: 47, 51, 53, 3155

| FIG. NO. | PRICE |
|----------|-------|
| 8955 | |



BELLOW BASE GASKET
Cat #150-9
Part #325300
Used In: 42, 150

| FIG. NO. | PRICE |
|----------|-------|
| 8962 | |

STEAM REGULATORS

WATSON McDANIEL PILOT OPERATED REGULATORS

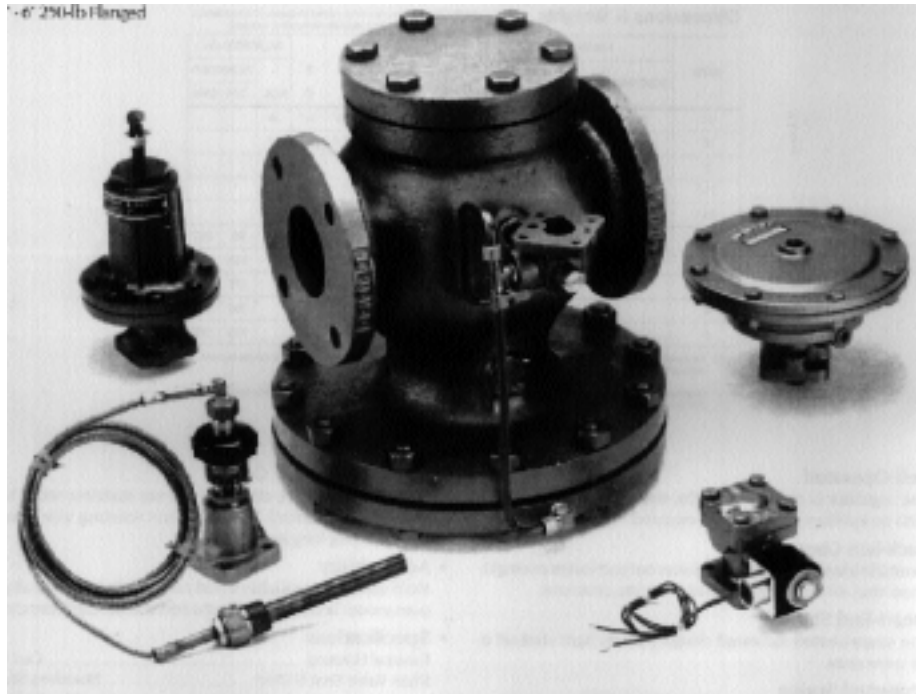

PILOTS

- ❖ Pressure
- ❖ Temperature
- ❖ Solenoid
- ❖ Air
- ❖ Back pressure
- ❖ Pneumatic temperature controller
- ❖ Electronic timing
- ❖ Any 3 combinations above per main valve

MAIN VALVES

- ❖ 1/2"-2" screwed
- ❖ 2"-6" 125-lb flanged
- ❖ 2"-6" 250-lb flanged

One main valve plus pilot or combination of pilots will perform pressure regulation, temperature regulation, solenoid regulation, back pressure regulation, pressure and temperature regulation, pressure, temperature, solenoid regulation, pressure/solenoid regulator, temperature/solenoid regulator, pneumotor temperature controller, air pilot, electronic timing control.

PRESSURE

- 3-25 psig yellow spring
- 20-100 psig blue spring
- 80-200 psig red spring

TEMPERATURE

- 60-120°F 100-160°F
- 120-180°F 160-220°F
- 160-220°F

BACK PRESSURE

- 10-25 psig
- 20-100 psig
- 80-200 psig

AIR PILOT

- 3-35 lb 1:1
- 3-100 lb 4:1
- 20-200 lb 6:1

PNEUMATIC TEMP CONTROLLER

- PTL-E7 50-350oF
- PTR-E8 0-300oF

SOLENOID

- 0-180 psig 120 volt
- 180-250 psig 120 volt
- Special 24 volt available

Main valves available 1/2" thru 2" threaded 250 psig @ 450 °F
 2" thru 6" 125 lb flanged 250 lb flanged

**CALL OUR HEATING EXPERTS FOR
 PRICING AND AVAILABILITY!**

STEAM TRAPS

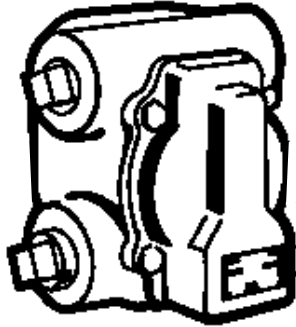

FLOAT & THERMOSTATIC STEAM TRAP - Designed to freely remove large quantities of condensate. For use on: Unit & space heaters, water heaters, converters, pressing machines, steam process equipment, draining mains & risers - low pressure, heat exchangers, coils. Features noiseless operation, in-line servicing, two side inlets & outlets - easy installation, valve, seat, float & air vent - stainless steel.

| | | RANGE | | | | | | | |
|-------|----------|-------|----------|--------|----------|--------|----------|---------|--|
| | | 15LB. | | 30 LB. | | 75 LB. | | 125 LB. | |
| SIZE | FIG. NO. | PRICE | FIG. NO. | PRICE | FIG. NO. | PRICE | FIG. NO. | PRICE | |
| 3/4 | 8924 | | 35680 | | 42541 | | 8947 | | |
| 1 | 8929 | | 35681 | | 42542 | | 8953 | | |
| 1 1/4 | 8941 | | 44772 | | 42543 | | 8960 | | |
| 1 1/2 | 8945 | | 47233 | | 42544 | | 8967 | | |
| 2 | 8946 | | 47234 | | 47235 | | 8970 | | |



INVERTED BUCKET STEAM TRAPS - Recommended for all services where the most important requirements are overall operating efficiency, freedom from maintenance, and long, trouble-free service life. Designed for pressing machines, tire molds, cookers, unit heaters, high-pressure drips, dryers, laundry equipment. Features only 2 moving parts, heat-treated stainless steel valve & seats, free-floating & frictionless valve lever assembly. All working part are attached to cover for in-line service.

| | | RANGE | | | | | | | | | | | | | |
|-------|----------|-------|----------|--------|----------|--------|----------|---------|----------|---------|----------|---------|----------|---------|--|
| | | 15LB. | | 30 LB. | | 75 LB. | | 125 LB. | | 150 LB. | | 200 LB. | | 250 LB. | |
| SIZE | FIG. NO. | PRICE | FIG. NO. | PRICE | FIG. NO. | PRICE | FIG. NO. | PRICE | FIG. NO. | PRICE | FIG. NO. | PRICE | FIG. NO. | PRICE | |
| 1/2 | 8983 | | 47243 | | 47244 | | 47245 | | 47246 | | | | | | |
| 3/4 | 47247 | | 47248 | | 47249 | | 47250 | | 47251 | | | | | | |
| 1 | 47245 | | 47257 | | 47259 | | 47260 | | | | | | | | |
| 1 1/4 | | | 8987 | | 47261 | | 47262 | | 47263 | | 47264 | | 47265 | | |
| 1 1/2 | | | 47266 | | 47267 | | 47268 | | 47269 | | 47270 | | 47271 | | |

TURBO DISC TRAP - Designed to remove condensate and air automatically from steam lines. Freeze-proof design can be easily achieved. Typical uses are: Sterilizers, pressing machines, tanks, tracer steam heating lines, industrial processing equipment, small dryers, high-pressure drips. Features: Stainless steel, excellent capability for handling light to medium loads, works efficiently in any position, snap-opening provides purging action in unit being drained, compact for easy installation. The disc trap uses the higher kinetic energy of flash steam over water to close the trap with static pressure.



| SIZE | FIG. NO. | PRICE |
|------|----------|-------|
| 3/8 | 47880 | |
| 1/2 | 48539 | |
| 3/4 | 49272 | |
| 1 | 49273 | |

STEAM RADIATOR TRAPS



NO. 17C Low pressure traps. Max operating pressure 25 PSI. 1/2" x 1/2" Angle.

| FIG. NO. | PRICE |
|----------|-------|
| 7632 | |



NO. 17C Swivel pattern. 1/2" X 1/2". Max 25 PSI

| FIG. NO. | PRICE |
|----------|-------|
| 7634 | |



NO. 17C VERTICAL PATTERN. 1/2" x 1/2" vertical. Max 25 LB PSI.

| FIG. NO. | PRICE |
|----------|-------|
| 7633 | |



NO. 8 TRAP-1/2"x1/2" angle pattern. All bronze body, brass cap and unions. The thermostat is of a non-corrosive alloy to give long life under actual service conditions. The thermostat and seat are renewable. Seat and pin are stainless steel. Max 50 lbs.

| FIG. NO. | PRICE |
|----------|-------|
| 7638 | |



NO. 9 TRAP-3/4"x3/4" or 1"x1" angle pattern only. All bronze body, brass cap and unions. The thermostat is of a non-corrosive alloy to give long life under actual service conditions. The thermostats and seats are renewable. Seat and pins are stainless steel. Max 50 lbs.

| SIZE | FIG. NO. | PRICE |
|------|----------|-------|
| 3/4 | 73739 | |
| 1 | 7637 | |



NO. 8C ANGLE STEAM TRAP - 3/4" pipe connections. Body, cap nut and tailpiece are of high quality brass. Seat and thermostat are renewable. The thermostat, pin and seat are constructed of a non-corrosive alloy to give long life under actual service conditions. Stainless steel pin and seat available. Max 25 PSI.

| FIG. NO. | PRICE |
|----------|-------|
| 7635 | |



NO. 8C STRAIGHTWAY STEAM TRAP. 3/4" pipe connection. For radiator or convector locations which will not permit the use of an angle trap. Body, cap, nut and tailpiece are of high quality brass. Thermostat, pin and set are constructed of a non-corrosive alloy for maximum life under actual service conditions. Seat and thermostat renewable. Stainless steel pin and seat available. Max 25 LBS.

| FIG. NO. | PRICE |
|----------|-------|
| 7636 | |



NO. 9C ANGLE STEAM TRAP - 1" pipe connections. Body, cap, nut and tailpiece are of high quality brass. Seat and thermostat are renewable. The thermostat, pin and seat are constructed of a non-corrosive alloy to give long life under actual service conditions. Stainless steel pin and seat available. Max 25 LBS.

| FIG. NO. | PRICE |
|----------|-------|
| 7637 | |

REPAIR KITS

| MODEL | FIG. NO. | PRICE |
|-------|----------|-------|
| 17C | 7647 | |
| 8C | 7648 | |

REGULATORS

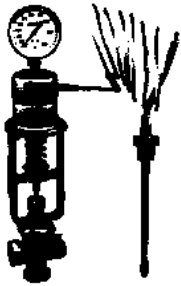

TEMPERATURE REGULATOR - used to increase the temperature of a medium (liquid or gas) by remotely sensing that medium's temperature and throttling steam flow to it. Typical uses are: plating or finishing tanks, hot water generators and storage tanks,

heat exchangers, fuel oil storage tanks and heaters, steam tables, open tank or kettle control, heating ducts, circulating dryers or ovens, sterilizing equipment.

Balanced main valve for better temperature control. Control down to $\pm 2^{\circ}\text{F}$. Dial thermometer optional.

| SIZE | FIG. NO. | PRICE |
|-------|----------|-------|
| 1/2 | 9055 | |
| 3/4 | 9056 | |
| 1 | 9058 | |
| 1 1/4 | 9059 | |
| 1 1/2 | 9063 | |
| 2 | 9064 | |

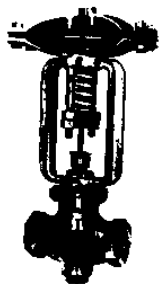

PRESSURE REGULATING VALVE - single-seated, unbalanced, tight-closing and recommended for dead end and/or continuous service. Used for the reduction of steam, water or any other fluid pressure in:

Industrial plants, public buildings, hotels, institutions, etc. Controls pressure where the supply to valve remains constant for: Laundry equipment, pressing machines, small heating systems, unit heaters, secondary water & air systems. Self powered, works off controlled medium.

| SIZE | FIG. NO. | PRICE |
|-------|----------|-------|
| 1/2 | 9025 | |
| 3/4 | 9028 | |
| 1 | 9030 | |
| 1 1/4 | 9031 | |
| 1 1/2 | 9033 | |
| 2 | 9034 | |



WATSON MCDANIEL (STYLE O)

Good for Steam

PRESSURE REDUCING VALVE - Pressure reduction for numerous types of systems and equipment industrial plants, hospitals, hotels, power plants, etc. A small, highly-versatile valve that

offers a wide range of reduced pressures. It provides accurate regulation where demand and incoming pressure are fairly constant.

| SIZE | RANG | FIG. NO. | PRICE |
|------|---------|----------|-------|
| 1/2 | 0-10 | 55610 | |
| 1/2 | 10-50 | 55612 | |
| 1/2 | 40-100 | 55613 | |
| 1/2 | 100-200 | 55620 | |
| 3/4 | 0-10 | 55615 | |
| 3/4 | 10-50 | 55617 | |
| 3/4 | 40-100 | 55618 | |
| 3/4 | 100-200 | 55619 | |
| 1 | 0-10 | 74792 | |
| 1 | 10-30 | 74793 | |
| 1 | 30-130 | 73875 | |

CALL FOR WATER AND AIR APPLICATIONS, OTHER SIZES AND RANGES READILY AVAILABLE!



SUCTION TEE

Cast iron, bronze or stainless steel construction.

APPLICATIONS

The suction tee is a specialized type of pipe fitting that is used for:

Blending, Agitation, Recirculation, Mixing, Aeration, Heating. Sizes 1/2" to 3".

The operation medium, under pressure, enters the suction tee through a convergent nozzle into the suction chamber. This action increases the velocity of the operating medium as it leaves the nozzle and lowers the pressure in the suction chamber. This causes the medium in the suction system to flow through the suction tee.

RELIEF VALVES



TYPE R ADJUSTABLE RELIEF VALVE. Recommended for unloading operations on oil, chemical, non-corrosive substances and water lines. Used for pump bypass relief, back pressure relief, open tank discharging and pump closing relief. Adjustment is done by removing the cap and adjusting the regulating screw. Installed in an upright, vertical position. **CAUTION: SHOULD NOT BE USED AS EMERGENCY OR SAFETY RELIEF VALVE.**

Found in the following applications:

- Water pump bypass
- Irrigation
- Sprinkler system on golf courses
- Fountains
- Fire protection systems
- Fuel Oil Pump
- Bypass on commercial systems or large residential systems.

| SIZE | 5-35 RANGE | | 25-100 RANGE | | 75-300 RANGE | |
|-------|------------|-------|--------------|-------|--------------|-------|
| | FIG. NO. | PRICE | FIG. NO. | PRICE | FIG. NO. | PRICE |
| 1/2 | 9066 | | 47308 | | 47309 | |
| 3/4 | 9069 | | 47310 | | 47311 | |
| 1 | 9073 | | 47312 | | 47313 | |
| 1 1/4 | 9076 | | 47314 | | 47315 | |
| 1 1/2 | 9078 | | 47316 | | 47317 | |
| 2 | 9081 | | 47318 | | 47319 | |
| 2 1/2 | 9084 | | 47320 | | 47321 | |
| 3 | 9087 | | 47322 | | 47323 | |

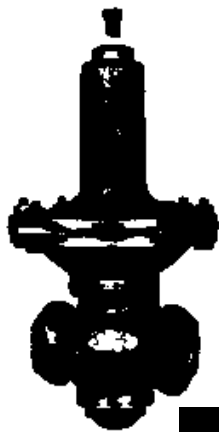

STYLE B PRESSURE REGULATING VALVE. Tight closing for dead end service for **water or air**. Single seated, balanced. For processing lines or wherever low-pressure equipment is subject to high-pressure damage. Recommended for industrial plant, apartment houses, office buildings, schools, underground water distribution systems. Screwed bronze body for 1/2" to 2 1/2". Flanged cast iron body for 3" to 8". Balanced pressure regulator insuring accurate control even when incoming pressure fluctuates.

| SIZE | 5-35 RANGE | | 20-70 RANGE | | 40-125 RANGE | |
|-------|------------|-------|-------------|-------|--------------|-------|
| | FIG. NO. | PRICE | FIG. NO. | PRICE | FIG. NO. | PRICE |
| 1 1/4 | 9017 | | 47278 | | 47279 | |
| 1 1/2 | 9018 | | 47280 | | 47281 | |
| 2 | 9019 | | 47282 | | 47283 | |
| 2 1/2 | 9020 | | 47284 | | 47285 | |
| 3 | 9022 | | 47286 | | 47287 | |
| 4 | 9024 | | 47288 | | 47289 | |

PRESSURE MOTIVE PUMPS

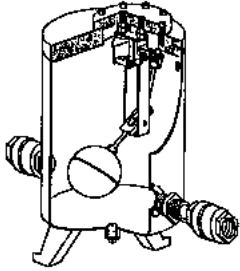

APPLICATIONS

The pressure motive pump (PMP) is recommended when liquids must be moved to a higher elevation, higher pressure or great distances. Typical applications are: Condensate from vacuum or low pressure system, Condensate systems with high back pressure, Any steam condensing equipment (ie, heat exchangers, condensers, turbines), Remote installation (ie. tanks farms) where electricity is not available, Where electricity is prohibited (ie some underground steam distribution systems, tank farms, etc.), Submersible, hard-to-get-at areas with fluids such as acids.

The series PUMP uses a spring-loaded float mechanism inside a pump body to control liquid removal. When the pump body is filled with liquid, which enters through a check valve, the vent valve at the top is open and the motive gas (steam or air) supply valve is closed.

When the spring loaded mechanism reaches the trip point and snaps over the center, the vent valve closes and the gas supply valve opens simultaneously. As the liquid in the body is pumped out through the outlet check valve, the float starts to drop. When the float reaches the critical point, the mechanism snaps over the center, the gas supply valve closes, and the vent valve opens, allowing the filling process to repeat.

SIZES: 1 x 1, 1 1/2 x 1, 2 x 1, 2 x 2, 3 x 2

DUFF HIGH QUALITY REPLACEMENT KITS FOR OTHER STEAM TRAP MANUFACTURERS

- * Quick, easy and economical.
- * All stainless steel corrosion resistant internal parts.
- * Hardened stainless steel condensate valves and seats for extra long life.

DRKS1 - The cover assembly consists of a complete, factory assembled unit which simply bolts on for ease of repair. No pipe connections need to be broken. There will be no reduction in the original traps capacity.

DRKS2 - Complete repair kits for large traps which have piping connections into the cover plate. To avoid the 'breaking' of piping connections, these kits are installed by removing the trap body. Each complete kit contains the thermostatic air vent, float, linkage, valve, seat and body gasket. These kits were designed to assure ease of installation.

For models of 75 or 125 psi, please contact your Duff representative for Figure Number.

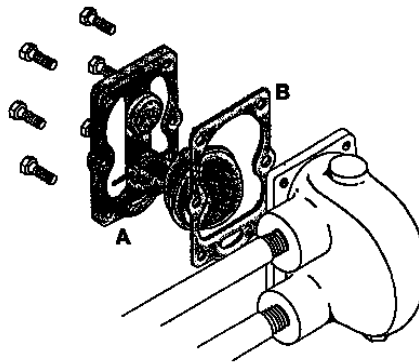

Series DRKS1 cover assemblies include the cast iron cover, condensate valve assembly, float and linkage, thermostatic vent in one factory assembled unit (A) and cover gasket (B).

| FITS MANUFACTURERS | | | | |
|--------------------|-------|-----------|----------|-------|
| MODEL | TRAP | LINE SIZE | FIG. NO. | PRICE |
| SARCO | FT-15 | 3/4" | 88261 | |
| SARCO | FT-30 | 3/4" | 88262 | |
| SARCO | FT-15 | 1" | 88266 | |
| SARCO | FT-30 | 1" | 88267 | |
| SARCO | FT-15 | 1 1/4" | 88268 | |
| SARCO | FT-30 | 1 1/4" | 88269 | |

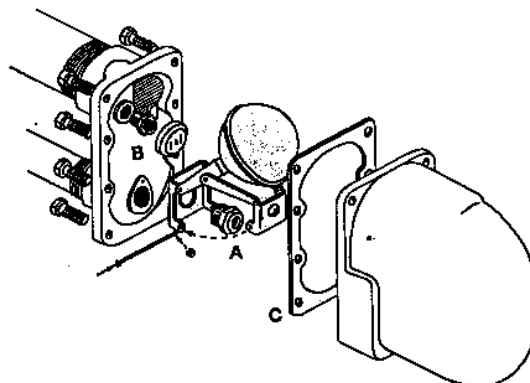

Series DRKS2 repair kits include condensate valve assembly - float and linkage (A), thermostatic vent and seat (B) and cover gasket (C).

THESE KITS ALSO FIT MANY
DUNHAM BUSCH , HOFFMAN &
WATTS/ILLINOIS TRAPS!
CALL FOR APPLICATIONS!
610-275-4453

| FITS MANUFACTURERS | | | | |
|--------------------|-------|-----------|----------|-------|
| MODEL | TRAP | LINE SIZE | FIG. NO. | PRICE |
| SARCO | FT-15 | 1 1/2" | 88273 | |
| SARCO | FT-30 | 1 1/2" | 88274 | |
| SARCO | FT-15 | 2" | 88275 | |
| SARCO | FT-30 | 2" | 88276 | |

STEAM CONDENSATE PUMP

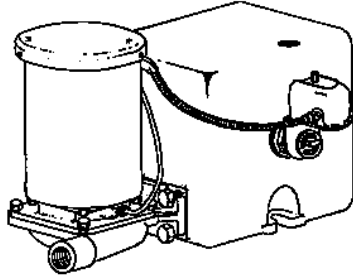

| DESCRIPTION | FIG. NO. | PRICE |
|---------------------|----------|-------|
| Pump Motor Assembly | 7655 | |
| Seal Kit | 7656 | |
| Float Switch | 7657 | |

HOFFMAN WATCHMAN SERIES WC CAST IRON RECEIVER CONDENSATE UNITS - 3500 RPM, 1 phase, 115V Mechanical seal, Cast Iron Receiver warranted against failure due to corrosion for 20 years from date of shipment.

| QEM# | FIG. NO. | SYSTEMS/FT EDR | NUMBER OF PUMPS | DISCH PRESS (psig) | PUMP CAPAC-ITY (GPM) | RECEIVER CAPACITY (GAL) | DIM | ACC | PRICE |
|----------------|----------|----------------|-----------------|--------------------|----------------------|-------------------------|-------|-----------------------|-------|
| WC-6-20-B | 47004 | 6000 | Single | 22 | 9 | 6 | 24x20 | Float switch | |
| WC-8-20-B | 7659 | 8000 | Single | 21 | 12 | 9 | 24x20 | Float switch | |
| WC-12-20-B | - | 12000 | Single | 20 | 18 | 14 | 26x31 | Float switch | |
| WCD-12-20-B MA | - | 12000 | Duplex | 20 | 18 | 14 | 26x31 | Mechanical Alternator | |

AUTOMATIC SUMP DRAINER

Designed to pump liquids from sumps automatically (when a pre-determined level is reached), without an outside power source. Most common applications are: Rain & ground water removal in manhole sumps, Draining of sumps in underground steam distribution systems.

HOW IT WORKS

The key piece of equipment in the automatic sump drainer is an ejector (or syphon) pump, which will pump liquid using steam as the operating medium.

3/4", 1", 1 1/4", 1 1/2" available!

Call today for pricing and availability!

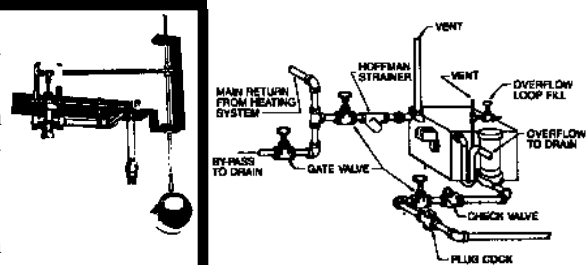

MAIN CONTROL AGA GAS BALL VALVE
Valves tapped 1/8"



| SIZE | FIG. NO. | PRICE |
|-------|----------|-------|
| 3/4 | 8488 | |
| 1 | 8492 | |
| 1 1/4 | 8494 | |
| 1 1/2 | 8498 | |
| 2 | 8502 | |

PILOT VALVE
1/8M X 1/4 OD



| DESCR | FIG. NO. | PRICE |
|-------|----------|-------|
| RH | 65576 | |
| LH | 65577 | |

LOW PRESSURE STEAM SAFETY RELIEF VALVE



ASME rated steam safety relief valves up to 450 lbs/hr. for low pressure steam heating equipment up to 15 lbs. Also available with lower setting such as 8 lbs. for pressure cooker requirements, but are not ASME, call us for rating and quotation. Set at 15#.

CONDENSATE REMOVAL PUMPS

Steam condensate. 2 Gallon cast reservoir. 115/230 volt.



| Cap. Sq Ft EDR | Max Steam BTU | Pump Discharge | Pump Cap. GPM | Fig. No. | Price |
|-----------------|---------------|----------------|---------------|----------|-------|
| 2000 | 480000 | 20 | 2 | 9120 | |
| SWITCH ASSEMBLY | | | | 9122 | |

| SIZE | FIG. NO. | PRICE |
|-------|----------|-------|
| 3/4 | 8419 | |
| 1 | 8427 | |
| 1 1/4 | 8430 | |
| 1 1/2 | 8432 | |
| 2 | 8439 | |
| 2 1/2 | 8441 | |
| 3 | 8444 | |

QUIK-FIX

QUIK-FIX RADIATOR STEAM TRAP REPLACEMENT KITS

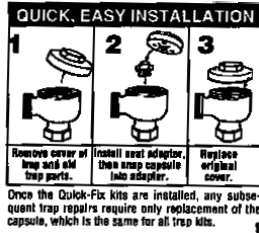
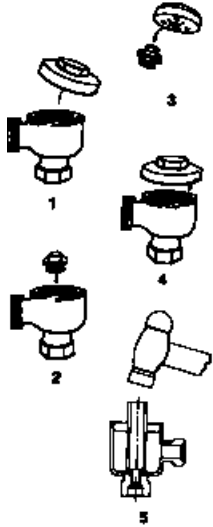

Designed so that it could be easily used to rebuild almost any of the popular radiator traps currently in use. Many of the original manufacturers models and parts for steam radiator traps are no longer available. Additionally, as existing heating systems expanded different traps were used creating a spare parts inventory problem. Quik Fix replacement kits address both these situations by offering a kit which induces a thermostatic capsule that is the same for all traps and a simple, easy to install adapter. Once installed, the steam trap operates like new. The Quik Fix kit uses no springs or gaskets, never needs a different cover or uses inaccurate bi-metal wafers.

PRESSURE RATINGS:

For pressures from 25" Hg vacuum to 65 psig
Meets or exceeds capacities according to recommended
SHEMA standards for 1/2" and 3/4" size low pressure
radiator traps.

FEATURES:

Quick, easy, economical
Simplifies/reduces inventory
Uses existing cover
Stainless steel capsule
Stainless steel adapters
3 year warranty

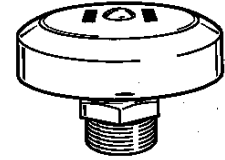

TRAPS WITH REPLACEABLE SETS

| MODEL # | MANUF | 1/2" TRAPS | 3/4" TRAPS | FIG. NO. |
|---------|-------------------------|--|--|----------|
| QF-1 | Warren Webster | O2H, 02V, 502, 502V-1, 702, 702V-1, 712, 902V | 503,703,713 | 58984 |
| QF-2 | Warren Webster | 512, 512H-1, 512G-1, 522, 522H,522HB, 712HB, 722HB | 513,533,5231,523H-1, 5236-1, 713HB, 733, 733HB, 723A | 58986 |
| QF-3 | Warren Webster | 902H | | 58988 |
| QF-4 | Warren Webster | | 913A, 913H | 58989 |
| QF-5 | Sarco | E, H, S65, TB25, TS25, T65 | E, H, S65, TB25, TS25, T65 | 58990 |
| | Erwel | R30 | | |
| | Illinois | 1G | 3GH | |
| | Trane | B1 | | |
| | Marsh Monash-Younger | 1 30 | | |
| QF-6 | Hoffman | 17C | 8C | 58133 |
| QF-14 | Marsh | | 2-4, 2-7 | 59005 |
| QF-15 | Sterling | 7-50A | | 59006 |
| QF-16 | Trane Dunham-Bush | | B3 TH2A | 59007 |

TRAPS WITH INTEGRAL SEATS

| | | | | |
|-------|------------------|-----------------|------------|-------|
| QF-7 | Dunham-Bush | 1B, 1C, 1E, V1B | | 58997 |
| | Trane | B2 | | |
| | Sarco | | T25 | |
| QF-8 | Sarco Hoffman | T25 8 | | 58998 |
| QF-9 | Illinois | 1T,2T | | 59000 |
| QF-10 | Barnes & Jones | 122A,122S,3045 | | 59001 |
| QF-11 | Barnes & Jones | | 134A, 134S | 59002 |
| QF-12 | Trane | B1 | | 59003 |
| QF-13 | Trane | | B3 | 59004 |

REPLACEMENT AIR VENTS FOR F&T TRAPS (15 AND 30 PSI)

| | | | | |
|-------|-------|--|-------------------|-------|
| QF-25 | Sarco | | Series FT 3/4"-2" | 59008 |
| QF-26 | Trane | | 686/55AL 3/4"-1" | 59009 |

STEAM TRAP REPAIRS

BARNES & JONES REPLACEMENT INTERIORS (CAGE UNITS) FOR VARIOUS OEM RADIATOR STEAM TRAPS

Renew worn out thermostatic steam traps the easy, efficient way by installing Barnes & Jones cage units in your **PRESENT TRAP BODIES**. The cage unit contains all working parts, plug, element & seat in one compact unit, correctly and permanently calibrated before leaving the factory. Barnes & Jones cage units are made for practically any make of thermostatic trap. Easy to install: ready to drop into your trap with no tapping or machining necessary.*

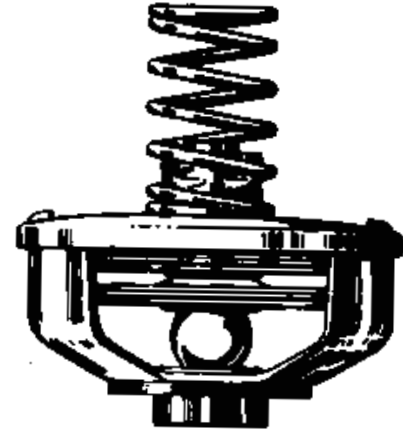

**CALL DUFF
FOR ALL YOUR STEAM NEEDS!
610-275-4453**

Barnes & Jones

Durham Bush

Hoffman

Milrois

Marsh

Sarco

Trane

Warren Webster

| B & J No. | Size | Type | Interior Replacements For OEM Numbers | Special Notes |
|-----------|----------|------|---|--|
| 1721 | 1/2" | A | 122A, 122B, 12, 3045 | |
| 1829 | 3/4" | A | 134A, 134B | |
| 1955 | 1-1/4" | A | 45T, 45A F&T Traps | |
| 1955 | 1-1/2" | A | 44T, 44A F&T Traps | |
| 1955 | 2" | A | 45T, 45T F&T Traps | |
| 1988* | 1/2" | A | 1(1A, 1B, 1C, 1D, 1E) | Less trap cover. Order following item if new trap cover is necessary. Includes new cover, necessary first time this cage unit is used. |
| 1988 | 1/2" | A | 1(1A, 1B, 1C, 1D, 1E) | |
| 1990* | 1/2" | A | 2(Small Body), 2E, 2A, 2B, 3A & #20 F&T | Less trap cover. Order following item if new trap cover is necessary. Includes new cover, necessary first time this cage is used. |
| 1990 | 1/2" | A | 2(Small Body), 2E, 2A, 2B, 3A & #20 F&T | |
| 3500 | 1/2" | A | 17C & 17D | |
| 3507 | 3/4" | A | 8C | |
| 2818* | 1/2" | A | 68, 70, 8G, 9G | Less trap cover. Order following item if new trap cover is necessary. Includes new cover, necessary first time this cage unit is used. |
| 2818 | 1"-2" | A | 68, 70, 8G, 9G | |
| 1927* | 1/2" | A | 1 & 1M | Less trap cover. Order following item if new trap cover is necessary. Includes new cover, necessary first time this cage unit is used. |
| 1927 | 1/2" | A | 1 & 1M | |
| 1971* | 1/2" | A | 2 | Less trap cover. Order following item if new trap cover is necessary. Includes new cover, necessary first time this cage unit is used. |
| 1971 | 1/2" | A | 2 | |
| 3443 | 3/4" | A | 2-4 | Less trap cover |
| 3053-C | 3/4" | A | 2-4 | Includes new cover, necessary first time this cage unit is used. |
| 4114 | 1/2" | A | E (Integral or Removable Seat) | |
| 4117 | 1/2" | A | H (Integral or Removable Seat) | |
| 4118 | 3/4" | A | H (Integral or Removable Seat) | |
| 3148 | 1/2-3/4" | A | H, E (Remove Existing Seat) | |
| 2854 | 1/2" | A | B-1 Removable Bellows | Less trap cover. Order following item if new trap cover is necessary. Includes new cover, necessary first time this cage unit is used. |
| 4328* | 1/2" | A | B-1 (Integral Bellows) | |
| 4320 | 1/2" | A | B-1 (Integral Bellows) | |
| 4321 | 1/2" | A | B-1 Vertical | |
| 1985 | 1/2" | A | B-2 Removable Bellows | |
| 4321* | 1/2" | A | B-2 Integral Bellows | Less trap cover. Order following item if new trap cover is necessary. Includes new cover, necessary first time this cage unit is used. |
| 4321 | 1/2" | A | B-2 Integral Bellows | |
| 4278* | 1/2" | A | B-1 (Integral Bellows Removable Seat) | Less trap cover. Order following item if new trap cover is necessary. Includes new cover, necessary first time this cage unit is used. |
| 4278 | 1/2" | A | B-1 (Integral Bellows Removable Seat) | |
| 3444* | 1/2" | A | B-2 (Integral Bellows Removable Seat) | Less trap cover. Order following item if new trap cover is necessary. Includes new cover, necessary first time this cage unit is used. |
| 3444 | 1/2" | A | B-2 (Integral Bellows Removable Seat) | |
| 1972 | 1/2" | A | 02H | |
| 1988 | 1/2" | A | 412H | |
| 1784 | 1/2" | A | 712 | |
| 3186 | 3/4" | A | 718HB | |
| 3479 | 1" | A | 8026T F&T | |
| 4122 | 1" | B | 724HB | |
| 4172 | 1/2" | A | 902H | Less trap cover. Order following item if new trap cover is necessary. Includes new cover, necessary first time this cage unit is used. |
| 4172-C | 1/2" | A | 902H | |

* On these models, a new trap cover is necessary the first time you use a B & J cage unit. Once you install a new B & J trap cover, all future renewals of trap will be made by the cage unit alone.

| B&J OEM No. | Replacement Cages Less Covers For OEM Steam Traps | B&J OEM No. | Replacement Cages Less Covers For OEM Steam Traps |
|-------------|---|-------------|---|
| 1721 | Barnes & Jones - 122A, 122B, 12, 3045 | 2818 | Milrois - 68, 70, 8G, 9G |
| 1784 | Warren Webster - 712 | 2854 | Trane - B-1 Removable Bellows |
| 1827 | Marsh - 1 & 1M | 3444 | Trane - B-2 Integral Bellows Removable Seat |
| 1950 | Durham - 1(1A, 1B, 1C, 1D, 1E) | 3500 | Hoffman - 17C & 17D |
| 1985 | Trane - B-2 Removable Bellows | 4114 | Sarco - E (Integral or Removable Seat) |
| 1971 | Marsh - 2 | 4117 | Sarco - H (Integral or Removable Seat) |
| 1872 | Warren Webster - 02H | 4221 | Trane - B-1 Vertical |
| 1990 | Durham - 2(Small Body), 2E, 2A, 2B, 3A, #20 F&T | 4278 | Trane - B-1 (Integral Bellows Removable Seat) |
| 1988 | Warren Webster - 412H | 4320 | Trane - B-1 (Integral Bellows) |
| | | 4321 | Trane - B-2 (Integral Bellows) |

PLEATED AIR FILTERS AIR FILTERS

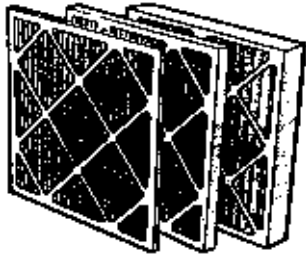

PLEATED AIR FILTERS offer the following advantages over conventional filters;

*Diagonal supports are designed for maximum open area while providing excellent structural stability in heavy dirt loading and high humidity.

*V-Shaped pleat design that provides the same open area on the air intake and air exiting sides for low airflow resistance.

*Heavy gauge beverage board that prevents moisture breakdown.

*Adhesives that are designed to maintain stability in normal temperature and humidity applications. Media-to-frame bond prevents air by-pass and maintains filter integrity over the life of the filter.

*The media is a blend of synthetic and natural fibers offering high dust-holding capacity and high efficiency.

ALL SIZES AVAILABLE!
SOLD IN CASE QUANTITY ONLY
PLEASE CALL FOR PRICING AND AVAILABILITY!

ELECTRONIC AIR CLEANERS

Many Styles-Designs to fit your needs



Whole house, offices, schools, restaurants & bars, duct mounted, ceiling mounted.

Page 334

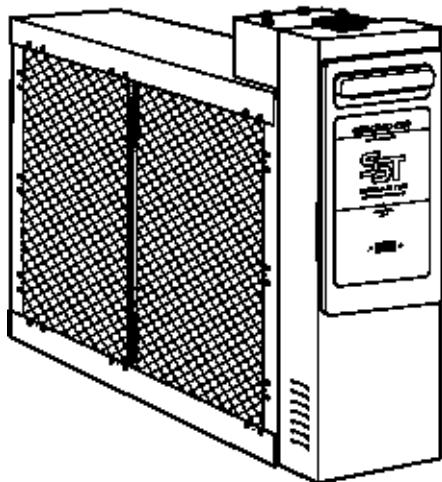

HIGH EFFICIENCY ELECTROSTATIC AIR FILTERS

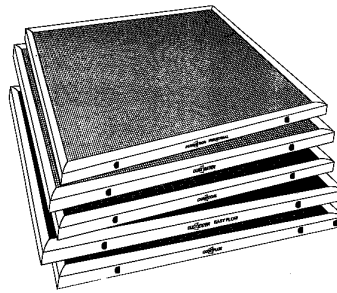

DUFF offers a variety because there isn't just one filter for every job!

Industrial - for commercial/industrial applications.

HFA - for areas with the toughest air filtration requirements.

Charcoal - for odor and fume removal.

Dust Eater - allergy filter for homes and special air filtering needs.

Filter for wall and window A/C units

Arrestance efficiencies form 50-96%

*Permanent, washable. Low resistance to air flow. Requires no electrical connections or modifications of HVAC system.

*Standard sizes available immediately: special sizes shipped within a few days.

Call today for your pricing and availability!

ALL SIZES AVAILABLE!
SOLD IN CASE QUANTITY ONLY
PLEASE CALL FOR PRICING AND AVAILABILITY!

MEDIA FILTERS AND REPLACEMENT ELEMENTS

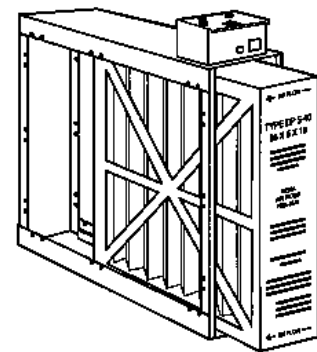

| DESCRIPTION | FIG. NO. | PRICE |
|-------------------|----------|-------|
| Research Products | 48844 | |
| April Aire | 48844 | |
| General AC-1 | 65387 | |
| Trion Air Bear | 82785 | |
| Trion Air Bear TM | 82786 | |

For additional information call: 610-275-4453 or Fax: 610-279-6299.
 Please call for current prices.

ALSO AVAILABLE IN 5'
OR 10' LENGTHS!

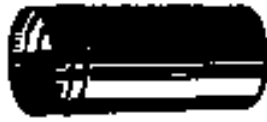

Galvanized Smoke Pipe.
2 Foot Sections.

| SIZE | FIG. NO. | PRICE |
|------|----------|-------|
| 3" | 3901 | |
| 4" | 3902 | |
| 5" | 3903 | |
| 6" | 3904 | |
| 7" | 3905 | |
| 8" | 3906 | |
| 9" | 3907 | |
| 10" | 3908 | |
| 12" | 3909 | |
| 14" | 3910 | |

SMOKE PIPE



Smoke pipe -
adjustable elbow.

| SIZE | FIG. NO. | PRICE |
|------|----------|-------|
| 3" | 3891 | |
| 4" | 3892 | |
| 5" | 3893 | |
| 6" | 3894 | |
| 7" | 3895 | |
| 8" | 3896 | |
| 9" | 3897 | |
| 10" | 3898 | |
| 12" | 3899 | |
| 14" | 3900 | |
| 18" | 37996 | |



Smoke Pipe Tee

| SIZE | FIG. NO. | PRICE |
|------|----------|-------|
| 3" | 3881 | |
| 4" | 3882 | |
| 5" | 3883 | |
| 6" | 3884 | |
| 7" | 3885 | |
| 8" | 3886 | |
| 9" | 3887 | |
| 10" | 3888 | |
| 12" | 3889 | |
| 14" | 3890 | |



Smoke Pipe Y

| SIZE | FIG. NO. | PRICE |
|------|----------|-------|
| 3" | 10837 | |
| 4" | 10839 | |
| 5" | 14155 | |
| 6" | 10846 | |
| 7" | 10851 | |
| 8" | 14819 | |
| 9" | 10858 | |
| 10" | 10859 | |



Smoke Pipe Reducers

| SIZE | FIG. NO. | PRICE | SIZE | FIG. NO. | PRICE |
|------|----------|-------|-------|----------|-------|
| 4X3 | 14791 | | 8X7 | 14805 | |
| 5X3 | 14792 | | 9X6 | 14808 | |
| 5X4 | 14793 | | 9X7 | 14809 | |
| 6X3 | 14794 | | 9X8 | 14811 | |
| 6X4 | 14795 | | 10X6 | 14812 | |
| 6X5 | 14796 | | 10X7 | 14813 | |
| 7X3 | 14797 | | 10X8 | 14814 | |
| 7X4 | 14798 | | 10X9 | 14815 | |
| 7X5 | 14799 | | 12X8 | 40023 | |
| 7X6 | 14800 | | 12X9 | 14816 | |
| 8X4 | 14802 | | 12X10 | 14817 | |
| 8X5 | 14803 | | 14X10 | 14818 | |
| 8X6 | 14804 | | 14X12 | 52341 | |



Shanty Cap

| SIZE | FIG. NO. | PRICE |
|------|----------|-------|
| 3" | 3911 | |
| 4" | 3912 | |
| 5" | 3913 | |
| 6" | 3914 | |
| 7" | 3915 | |
| 8" | 3916 | |
| 9" | 3917 | |
| 10" | 3918 | |
| 12" | 3919 | |



Smoke Pipe CO Cap

| SIZE | FIG. NO. | PRICE |
|------|----------|-------|
| 3" | 3920 | |
| 4" | 3921 | |
| 5" | 3922 | |
| 6" | 3923 | |
| 7" | 3924 | |
| 8" | 3925 | |
| 9" | 3926 | |
| 10" | 3927 | |
| 12" | 3928 | |
| 16" | 36244 | |



Smoke Pipe Damper

| SIZE | FIG. NO. | PRICE |
|------|----------|-------|
| 4" | 14456 | |
| 5" | 14457 | |
| 6" | 14458 | |
| 7" | 14459 | |
| 8" | 14460 | |
| 9" | 14461 | |
| 10" | 14462 | |
| 12" | 14463 | |



CASING COLLARS
Flat collars with crimp

| SIZE | FIG. NO. | PRICE |
|------|----------|-------|
| 5" | 45265 | |
| 6" | 45266 | |
| 7" | 45267 | |
| 8" | 45268 | |

ZIP-IN SCREWS



| SIZE | CTN QTY | FIG. NO. | PRICE EA |
|---------|---------|----------|----------|
| 6X3/8 | 100 | 16176 | |
| 7X1/2 | 100 | 16178 | |
| 8X1/2 | 100 | 16179 | |
| 8X3/4 | 100 | 16181 | |
| 8X1 | 100 | 16182 | |
| 8X1 1/2 | 100 | 16183 | |
| 10X12 | 100 | 16186 | |

ALL FUEL STAINLESS STEEL AND ALUMINUM CHIMNEY LINER KIT

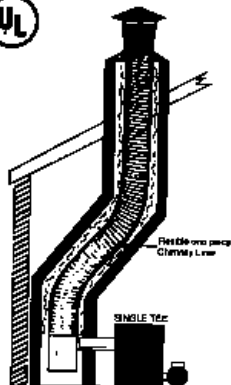

READY FOR IMMEDIATE DELIVERY

CALL WITH YOUR SPECIFICATIONS!

DRAFT REGULATOR

For oil and solid fuel

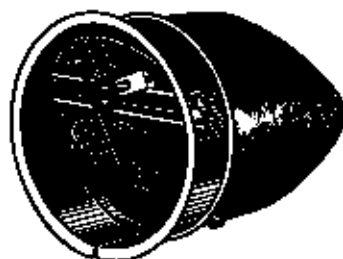

SIZE FIG. NO. PRICE

| | | |
|-----|------|--|
| 5" | 9602 | |
| 6" | 3942 | |
| 7" | 3943 | |
| 8" | 3944 | |
| 9" | 3945 | |
| 10" | 3946 | |
| 12" | 3947 | |

HEATING ACCESSORIES

ALL FUEL CHIMNEY



For use with low-heat appliances. Sized 6" to 12"

Call now for specs!

TYPE B GAS VENT



For venting all listed gas appliances having draft hoods. Sized 3" to 8". Oval and round.

Call now for specs!

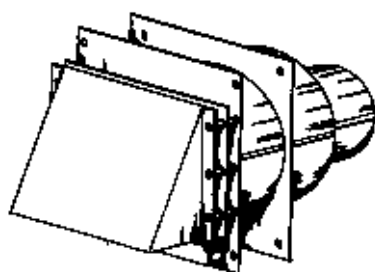

FIELD TYPE SWH SIDE WALL VENT HOOD Designed for standard vent pipe and Class B type double wall connection to be used inside wall venting of oil or gas fired heating systems. Provides proper clearances between flue-gas stream and wall combustibles. Available for immediate delivery in 3", 4", 5" 6" and 8" sizes.

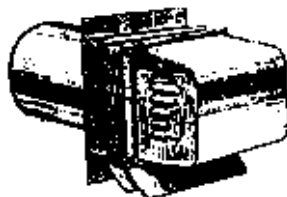

FIELD POWER VENTERS MODEL SWG Our new, patented power venter design is a giant step forward in the evolution of sidewall venting. It's the safe, economical, easy to install answer to power venting. The SWG series from field controls combines the fan, motor and vent hood into one complete and compact unit that's easily installed outside the building, so noise and vibration are virtually eliminated from the occupied areas. Venting with negative pressure, the SWG prevents possible flue gas leakage from the venting system. Plus, the unique design allows for easy use of outside air for direct vent appliances. Available for immediate delivery in 3", 4", 5", 6", 7", and 8" sizes.

FIELD POWER VENTERS MODELS PVAE-1, PVAE-2, PVAE-3

For side wall venting of natural gas, LP gas or No. 2 fuel oil furnaces, boilers, water heaters, and unit heaters. Produces constant flow for higher combustion efficiency and safe flue gas removal. This significant fuel and installation savings device has qualified for listing by ETL Testing Laboratories and provides a positive venting capacity of up to 610,000 BTU/HR.

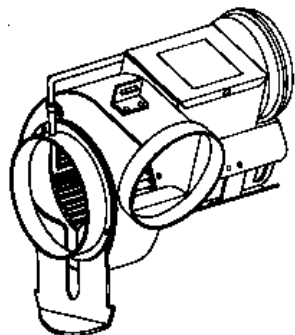

DUCT



VINYL COVERED FLEXDUCT FLEXIBLE HOSE

Vinyl covered high-tensile steel wire covered with vinyl impregnated fiberglass cloth. Temp range = 0-250oF. Gray canvas with wire. Simple to connect and install.

- *Flexible duct connectors
- *General purpose venting
- *Fume and dust removal
- *Drying and cooling
- *Plating tank vents
- *Oil vapor vents
- *25' Coils

LIGHT WEIGHT HEAVY DUTY

| SIZE | FIG. NO. | PRICE | SIZE | FIG. NO. | PRICE |
|------|----------|-------|--------|----------|-------|
| 3" | 14529 | | 2" | 14464 | |
| 4" | 14535 | | 2 1/2" | 14465 | |
| 5" | 14537 | | 3" | 14466 | |
| 6" | 14539 | | 4" | 14467 | |
| 7" | 14541 | | 5" | 14468 | |
| 8" | 14543 | | 6" | 14469 | |
| 9" | 14544 | | 7" | 14470 | |
| 10" | 14545 | | 8" | 14471 | |
| 12" | 14548 | | 10" | 14473 | |
| 14" | 14550 | | 12" | 14475 | |
| | | | 14" | 14476 | |



INSULATED DUCT 25' SECTIONS

Smooth inner core - Air tight
 Low to medium operating air pressure
 Double thick fiberglass
 Silver jacket
 Compliance to UL, BOCA, HUD

| SIZE | FIG. NO. | PRICE |
|------|----------|-------|
| 5" | 45269 | |
| 6" | 45270 | |
| 7" | 45271 | |
| 8" | 45272 | |



FLEXIBLE METAL DUCT

Fits standard sheet metal fittings
 Self-supporting
 Eliminates Fittings
 Excellent air flo
 Lightweight aluminum
 8' compressed to 30"

| SIZE | FIG. NO. | PRICE |
|------|----------|-------|
| 3x8 | 14551 | |
| 4x8 | 14553 | |
| 5x8 | 14556 | |
| 6x8 | 14558 | |
| 7x8 | 14560 | |
| 8x8 | 14561 | |
| 10x8 | 14563 | |
| 12x8 | 14564 | |
| 14x8 | 14567 | |
| 16x8 | 14568 | |
| 18x8 | 14570 | |

DUCT SEAL COMPOUND



| | FIG. NO. | PRICE |
|------|----------|-------|
| 1 lb | 52596 | |
| 5 lb | 49003 | |

4 IN 1 DRYER VENT KIT

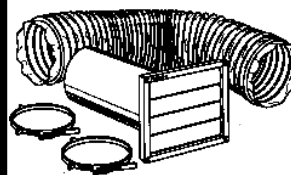

| DESCR | FIG. NO. | PRICE |
|-----------|----------|-------|
| KIT | 3949 | |
| 4" Hood | 14477 | |
| Only | | |
| 4" Clamps | 14519 | |

DRYER VENT HOSE



| SIZE | FIG. NO. | PRICE |
|-------------|----------|-------|
| 3" PER FOOT | 38017 | |
| 4" PER FOOT | 21297 | |
| 4" X 20' | 14525 | |
| 4X8' | 14523 | |
| 4X50' | 14526 | |



HEAT BY THE FOOT! Unlike conventional "series heaters", FROSTEX is constructed with parallel electrical circuitry. This allows it to be cut to any length without changing its heat output per foot. Specially designed power plug and end cap complete the heater assembly quickly and easily. The heating element in FROSTEX is a continuous core of semi-conductive polymer plastic that varies its electrical resistance with temperature change. Safer, longer lasting and more reliable! Won't overheat, needs NO thermostat, OK for steel, copper and plastic pipe. **CUT TO ANY LENGTH.**

TRUCK PACK includes; 50' Frostex, 2 Plug kits, 1 applications tape.

Frostex™ Pipe-Heating System



- Fast, easy installation
- Good for plastic pipes too!
- Unsurpassed reliability
- No call backs



| DESCRIPTION | FIG. NO. | PRICE |
|----------------------|----------|-------|
| 100' Roll Frostex | 9141 | |
| 250' Roll Frostex | 67758 | |
| Truck Pack | 98404 | |
| Plug Kit w/ end seal | 64129 | |
| Application Tape | 46873 | |

HEAT TAPES Self-regulating heat tape with plug 120 Volt. Packaged ready to use!

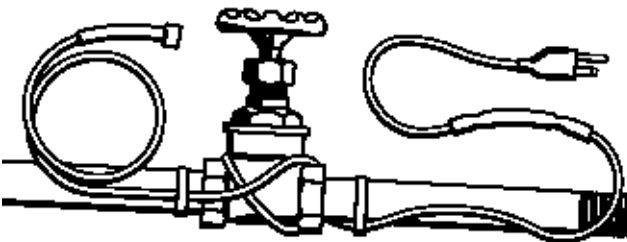

| LENGTH | FIG. NO. | PRICE |
|--------|----------|-------|
| 6' | 9162 | |
| 13' | 56719 | |
| 18' | 56721 | |
| 24' | 9169 | |
| 50' | 62232 | |
| 100' | 62233 | |

WINTERGUARD WET PIPE HEATING CABLE

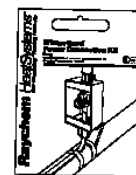
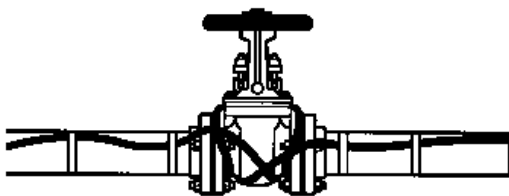

For marine, farm, industrial & commercial pipe, ice formations or roofs and to keep drain running free. 120 V. (220 available).

Won't burnout, won't over heat, No thermostat required, OK to overlap, OK for plastic-steel-brass-etc. UL & LSA approved.

TRUCK PACK includes 100 Ft, 2 power ends, 1 splice kit and tee, 1 application tape.

| DESCRIPTION | FIG. NO. | PRICE |
|------------------|----------|-------|
| Per foot | 9148 | |
| 250' roll | 9149 | |
| Truck pack | 9150 | |
| Power connection | 9151 | |
| Plug in cord | 51162 | |
| Splice tee kit | 9152 | |
| Tape | 9154 | |

RUBATEX
ARMAFLEX/RUBATEX - Closed Cell Pipe Insulation.

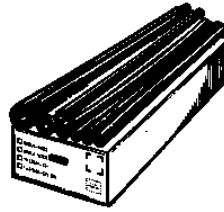

| IRON PIPE | | | | | | | | | | | |
|------------|---------------------|---------|----------------|---------------------|---------|----------------|---------------------|---------|----------------|-------------------|----------------|
| DIAMETER | 3/8" WALL THICKNESS | | | 1/2" WALL THICKNESS | | | 3/4" WALL THICKNESS | | | 1" WALL THICKNESS | |
| | FIG. NO. | BOX QTY | PRICE PER FOOT | FIG. NO. | BOX QTY | PRICE PER FOOT | FIG. NO. | BOX QTY | PRICE PER FOOT | FIG. NO. | PRICE PER FOOT |
| 1/4" IPS | 13945 | 480 | | 13956 | 360 | | 28592 | 216 | | - | |
| 3/8" IPS | 13946 | 420 | | 13957 | 306 | | 28593 | 168 | | - | |
| 1/2" IPS | 13948 | 306 | | 13959 | 252 | | 28595 | 144 | | - | |
| 3/4" IPS | 13949 | 252 | | 13960 | 168 | | 28596 | 120 | | 28627 | |
| 1" IPS | 13950 | 168 | | 13961 | 144 | | 28597 | 96 | | 56753 | |
| 1 1/4" IPS | 13951 | 144 | | 13962 | 120 | | 28598 | 96 | | 28609 | |
| 1 1/2" IPS | 17775 | 120 | | 17785 | 120 | | 28619 | 72 | | 62023 | |
| 2" IPS | 17776 | 96 | | 17786 | 72 | | 28620 | 54 | | 28631 | |
| 2 1/2" IPS | 17777 | 72 | | 17787 | 54 | | 28621 | 36 | | 28632 | |
| 3" IPS | 17778 | 54 | | 17788 | 48 | | 28622 | 30 | | 62028 | |
| 4" IPS | - | - | | 17790 | 24 | | 28624 | 24 | | 62027 | |

| NOMINAL COPPER TUBE | | | | | | | | | | |
|---------------------|------------|---------------------|---------|----------------|---------------------|---------|----------------|---------------------|---------|----------------|
| COPPER TUBE SIZE | | 3/8" WALL THICKNESS | | | 1/2" WALL THICKNESS | | | 3/4" WALL THICKNESS | | |
| OD | NOMINAL | FIG. NO. | BOX QTY | PRICE PER FOOT | FIG. NO. | BOX QTY | PRICE PER FOOT | FIG. NO. | BOX QTY | PRICE PER FOOT |
| 3/8 | 1/4" CTS | 13944 | 600 | | 13955 | 384 | | 28591 | 252 | |
| 1/2 | 3/8" CTS | 13945 | 480 | | 13956 | 360 | | 28592 | 216 | |
| 5/8 | 1/2" CTS | 13946 | 420 | | 13957 | 306 | | 28593 | 168 | |
| 3/4 | 5/8" CTS | 13947 | 336 | | 13958 | 252 | | 28594 | 180 | |
| 7/8 | 3/4" CTS | 13948 | 306 | | 13959 | 252 | | 28595 | 144 | |
| 1 1/8 | 1" CTS | 13949 | 252 | | 13960 | 168 | | 28596 | 120 | |
| 1 3/8 | 1 1/4" CTS | 13950 | 168 | | 13961 | 144 | | 28597 | 96 | |
| 1 5/8 | 1 1/2" CTS | 13951 | 144 | | 13962 | 120 | | 28598 | 96 | |
| 2 1/8 | 2" CTS | 13952 | 108 | | 13963 | 96 | | 28599 | 72 | |
| 2 5/8 | 2 1/2" CTS | 13953 | 72 | | 13964 | 72 | | 28600 | 54 | |
| 3 1/8 | 3" CTS | 13954 | 54 | | 13965 | 48 | | 28601 | 36 | |
| 3 5/8 | 3 1/2" CTS | - | - | | 55435 | 48 | | 28602 | 30 | |
| 4 1/8 | 4" CTS | - | - | | 13966 | 30 | | 28603 | 24 | |

RUBATEX SHEETS

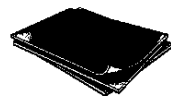

| SIZE | FIG. NO. | PRICE |
|-----------|----------|-------|
| 1/4X36X48 | 28634 | |
| 1/2X36X48 | 23980 | |
| 3/4X36X48 | 23981 | |
| 1X36X48 | 28637 | |



RUBATEX CEMENT

For closed cell insulation

| | FIG. NO. | PRICE |
|-------|----------|-------|
| PINT | 13992 | |
| QUART | 14138 | |

FIBERGLASS PIPE INSULATION

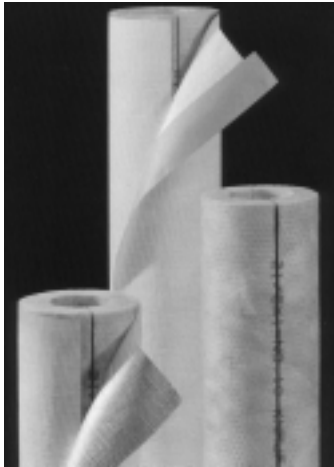

Thickness to Prevent Surface Condensation ASJ All-Service Jacket for up to 16" (376mm) NPS (1)

| Ambient Temp. | Relative Humidity | System Operating Temperature | | |
|---------------|-------------------|------------------------------|------------|------------|
| | | 35F (2°C) | 45F (7°C) | 55F (13°C) |
| 110F (43°C) | 50% - 70% | 1" (25mm) | 1" (25mm) | 1" (25mm) |
| | 80% | 1½" (38mm) | 1½" (38mm) | 1" (25mm) |
| | 90% | 3½" (89mm) | 3" (76mm) | 2½" (64mm) |
| 100F (38°C) | 50% - 70% | 1" (25mm) | 1" (25mm) | 1" (25mm) |
| | 80% | 1½" (38mm) | 1½" (38mm) | 1" (25mm) |
| | 90% | 3" (76mm) | 3" (76mm) | 2½" (64mm) |
| 90F (32°C) | 50% - 70% | 1" (25mm) | 1" (25mm) | 1" (25mm) |
| | 80% | 1½" (38mm) | 1" (25mm) | 1" (25mm) |
| | 90% | 3" (76mm) | 2½" (64mm) | 2" (51mm) |
| 80F (27°C) | 50% - 80% | 1" (25mm) | 1" (25mm) | 1" (25mm) |
| | 90% | 2½" (64mm) | 2" (51mm) | 1½" (38mm) |
| | 90% | 1" (25mm) | 1" (25mm) | 1" (25mm) |
| 70F (21°C) | 50% - 80% | 1" (25mm) | 1" (25mm) | 1" (25mm) |
| | 90% | 1½" (38mm) | 1½" (38mm) | 1" (25mm) |
| | 90% | 1" (25mm) | 1" (25mm) | 1" (25mm) |

EASY ON FIBERGLASS PIPE COVERING

Heavy density - in 3 foot lengths

For use on surface temperatures to 500°F (160°C)

650°F (343°C) when applied min. 2" thick

SEE PAGE 128 FOR INSULATION SHIELDS!

ALL SERVICE JACKET WITH SELF-SEALING LIP!

IRON PIPE

| IPS DIAMETER | 1/2" WALL THICKNESS | | | 1" WALL THICKNESS | | | 1 1/2" WALL THICKNESS | | | 2" WALL THICKNESS | | |
|--------------|---------------------|---------|----------------|-------------------|---------|----------------|-----------------------|---------|----------------|-------------------|---------|----------------|
| | FIG. NO. | BOX QTY | PRICE PER FOOT | FIG. NO. | BOX QTY | PRICE PER FOOT | FIG. NO. | BOX QTY | PRICE PER FOOT | FIG. NO. | BOX QTY | PRICE PER FOOT |
| 3/8" | 13887 | 270 | | 13900 | 126 | | 13913 | 84 | | 28563 | 72 | |
| 1/2" | 13888 | 270 | | 13936 | 126 | | 61994 | 84 | | 28564 | 72 | |
| 3/4" | 13889 | 180 | | 13902 | 126 | | 13915 | 84 | | 28565 | 72 | |
| 1" | 13890 | 180 | | 13903 | 90 | | 13916 | 87 | | 28566 | 57 | |
| 1 1/4" | 13930 | 126 | | 13939 | 90 | | 13917 | 72 | | 28567 | 57 | |
| 1 1/2" | 13892 | 126 | | 13905 | 108 | | 13914 | 72 | | 28568 | 57 | |
| 2" | 13893 | 90 | | 13906 | 87 | | 13919 | 57 | | 28569 | 36 | |
| 2 1/2" | 13894 | 108 | | 13907 | 72 | | 13920 | 57 | | 28570 | 36 | |
| 3" | 13895 | 87 | | 13908 | 57 | | 13921 | 36 | | 28571 | 27 | |
| 4" | 13897 | 57 | | 13910 | 36 | | 13923 | 27 | | 28573 | 21 | |
| 5" | 13898 | 36 | | 13911 | 27 | | 13924 | 21 | | 28574 | 12 | |
| 6" | 13899 | 27 | | 13912 | 21 | | 13925 | 18 | | 28575 | 12 | |
| 8" | 28579 | 18 | | 20167 | 12 | | 28586 | 12 | | 28576 | 12 | |
| 10" | 28580 | 12 | | 28583 | 12 | | 28587 | 12 | | 28577 | 10 | |
| 12" | 28581 | - | | 28585 | 12 | | 28588 | 6 | | 28578 | 6 | |

COPPER TUBE SIZE

COPPER TUBE

| OD | NOM | 1/2" WALL THICKNESS | | | 1" WALL THICKNESS | | | 1 1/2" WALL THICKNESS | | | 2" WALL THICKNESS | | |
|-------|--------|---------------------|---------|----------------|-------------------|---------|----------------|-----------------------|---------|----------------|-------------------|---------|----------------|
| | | FIG. NO. | BOX QTY | PRICE PER FOOT | FIG. NO. | BOX QTY | PRICE PER FOOT | FIG. NO. | BOX QTY | PRICE PER FOOT | FIG. NO. | BOX QTY | PRICE PER FOOT |
| 5/8 | 1/2" | 13887 | 270 | | 13900 | 126 | | 13913 | 84 | | 28563 | 72 | |
| 7/8 | 3/4" | 13888 | 270 | | 13936 | 126 | | 61994 | 84 | | 28564 | 72 | |
| 1 1/8 | 1" | 13889 | 180 | | 13902 | 126 | | 13915 | 84 | | 28565 | 72 | |
| 1 3/8 | 1 1/4" | 13929 | 180 | | 13938 | 90 | | - | - | | - | - | |
| 1 5/8 | 1 1/2" | 13930 | 126 | | 13939 | 90 | | 13917 | 72 | | - | - | |
| 2 1/8 | 2" | 13931 | 90 | | 13940 | 87 | | 38053 | 57 | | - | - | |
| 2 5/8 | 2 1/2" | 13932 | 108 | | 13941 | 72 | | - | - | | - | - | |
| 3 1/8 | 3" | 13933 | 87 | | 13942 | 57 | | - | - | | - | - | |
| 4 1/8 | 4" | 13934 | 72 | | 13943 | 36 | | - | - | | - | - | |

ZESTON FITTINGS

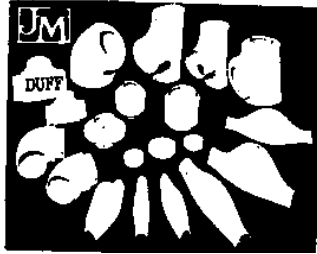

ZESTON pre-molded PVC fitting covers for fiberglass insulation. Pre-molded PVC insulated fitting covers temperatures to 500°F. High-low temperature inserts furnished with fitting. Secured by tacking, banding or taping ends to adjacent pipe covering.

Copper Tube Table

| Copper Tubing Actual O.D. | Insulation Thickness | | | | | | | | |
|---------------------------|----------------------|------|----|--------|-----|--------|-----|--------|-----|
| | 1/2" | 3/4" | 1" | 1 1/2" | 2" | 2 1/2" | 3" | 3 1/2" | 4" |
| 1/2" | — | — | #5 | #9 | #11 | #13 | #15 | — | — |
| 5/8" | #3 | #2 | 7 | 9 | 11 | 13 | 15 | — | — |
| 7/8" | 3 | 3 | 7 | 10 | 12 | 15 | 17 | #18 | #19 |
| 1 1/8" | 5 | 4 | 7 | 10 | 12 | 15 | 17 | 18 | 19 |
| 1 3/8" | 5 | 5 | 9 | 11 | 13 | 15 | 17 | 18 | 19 |
| 1 5/8" | 7 | 6 | 9 | 12 | 13 | 15 | 17 | 18 | 19 |
| 2 1/8" | 9 | 8 | 10 | 12 | 15 | 17 | 18 | 19 | 20 |
| 2 3/8" | 10 | 9 | 11 | 13 | 15 | 17 | 18 | 19 | 20 |
| 3 1/8" | 11 | 10 | 12 | 15 | 17 | 18 | 19 | 20 | 21 |
| 3 3/8" | 11 | 11 | 13 | 15 | 17 | 18 | 19 | 20 | 21 |
| 4 1/8" | 13 | 12 | 15 | 17 | 18 | 19 | 20 | 21 | 22 |
| 5 1/8" | 15 | 14 | 17 | 18 | 19 | 20 | 21 | 22 | 23 |
| 6 1/8" | 17 | 16 | 18 | 19 | 20 | 21 | 22 | 23 | 24 |

Above fit long radius and short radius, 90°, 45° and Tee. On 90° long radius Copper Tubing Elbows, push pipe covering about 1" onto fittings before applying cover.

| Iron Pipe Size | Insulation Thickness | | | | | | | | |
|----------------|----------------------|------|----|--------|----|--------|----|--------|----|
| | 1/2" | 3/4" | 1" | 1 1/2" | 2" | 2 1/2" | 3" | 3 1/2" | 4" |
| 3/8" | #2 | #7 | #9 | | | | | | |
| 1/2" | 3 | 7 | 10 | 12 | 15 | 17 | 18 | 19 | |
| 3/4" | 5 | 4 | 7 | 10 | 12 | 15 | 17 | 18 | 19 |
| 1" | 5 | | 9 | 11 | 13 | 15 | 17 | 18 | 19 |
| 1 1/4" | 7 | 6 | 9 | 12 | 13 | 15 | 17 | 18 | 19 |
| 1 1/2" | 7 | | 10 | 12 | 15 | 17 | 18 | 19 | 20 |
| 2" | 9 | | 11 | 13 | 15 | 17 | 18 | 19 | 20 |
| 2 1/2" | 10 | | 12 | 15 | 17 | 18 | 19 | 20 | 21 |
| 3" | 11 | | 13 | 15 | 17 | 18 | 19 | 20 | 21 |
| 3 1/2" | 12 | | 15 | 17 | 18 | 19 | 20 | 21 | 22 |
| 4" | 13 | | 15 | 17 | 18 | 19 | 20 | 21 | 22 |
| 5" | 15 | | 17 | 18 | 19 | 20 | 21 | 22 | 23 |
| 6" | 17 | | 18 | 19 | 20 | 21 | 22 | 23 | 24 |
| 8" | 19 | | 20 | 21 | 22 | 23 | 24 | 25 | 26 |
| 10" | 21 | | 22 | 23 | 24 | 25 | 26 | 27 | 28 |
| 12" | | | 24 | 25 | 26 | 27 | 28 | 29 | 30 |
| 14" | | | 25 | 26 | 27 | 28 | 29 | 30 | 31 |
| 16" | | | 27 | 28 | 29 | 30 | 31 | 32 | 33 |
| 18" | | | 29 | 30 | 31 | 32 | 33 | 34 | 35 |
| 20" | | | 31 | 32 | 33 | 34 | 35 | 36 | 37 |
| 22" | | | 33 | 34 | 35 | 36 | 37 | 38 | 39 |
| 24" | | | 35 | 36 | 37 | 38 | 39 | 40 | 41 |

| ZESTON # | 90 | | 45 | | TEE | |
|----------|----------|-------|----------|-------|----------|-------|
| | FIG. NO. | PRICE | FIG. NO. | PRICE | FIG. NO. | PRICE |
| 3 | 13969 | | 13987 | | 14120 | |
| 4 | 13970 | | 13988 | | 14121 | |
| 5 | 13971 | | 13989 | | 14122 | |
| 6 | 13972 | | 13990 | | 14123 | |
| 7 | 13973 | | 13991 | | 14124 | |
| 8 | 13974 | | 14107 | | 14125 | |
| 9 | 13975 | | 14108 | | 14126 | |
| 10 | 13976 | | 14109 | | 14127 | |
| 11 | 13977 | | 14110 | | 14128 | |
| 12 | 13978 | | 14111 | | 14129 | |
| 13 | 13979 | | 14112 | | 14130 | |
| 14 | 13980 | | 14113 | | 14131 | |
| 15 | 13981 | | 14114 | | 14132 | |
| 16 | 13982 | | 14115 | | 14133 | |
| 17 | 13983 | | 14116 | | 14134 | |
| 18 | 13984 | | 14117 | | 14135 | |
| 19 | 13985 | | 14118 | | 14136 | |
| 20 | 13986 | | 14119 | | 14137 | |
| 22 | 38442 | | 38441 | | 38443 | |
| 25 | 38562 | | 38563 | | - | |

INSULATION ACCESSORIES

RUBATEX FOAM TAPE

2" X 30'



For thermal insulation of hot or cold pipe, fittings and valves. Stops condensation, reduces heat loss on heated pipes and fittings, seals out air, sound and dirt, convenient and easy to apply - self adhering rolls, will not dry out, decay or crack.

| FIG. NO. | PRICE |
|----------|-------|
| 28638 | |



Fast easy way to bond materials such as fibrous glass, paper foil, cork, polystyrene foam plastic sheeting, foam rubber, cardboard felt, cloth, etc. to themselves or to metal, glass and wood.

| FIG. NO. | PRICE |
|----------|-------|
| | |

FAX YOUR ORDER!
610-279-6299

CORK INSULATION TAPE

2" x 30'



Especially for use on cold pipe associated with air-conditioning systems, commercial refrigeration, wherever the problem of condensation needs to be controlled.

Especially for use on cold pipe associated with air-conditioning systems, commercial refrigeration, wherever the problem of condensation needs to be controlled.

| FIG. NO. | PRICE |
|----------|-------|
| 21472 | |

ALUMINUM FOIL TAPE

3" X 50'

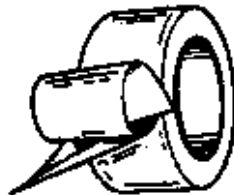

Self Adhering
Great for duct board!

| FIG. NO. | PRICE |
|----------|-------|
| 43259 | |

PROTECTIVE COATING



White preflex protective coating gives an attractive high gloss, flexible protective coating to tubing insulations. Open cell for both indoor and outdoor applications. Can be

spray, dip, brush, mitten or roller applied. Two coats are recommended.

| FIG. NO. | PRICE |
|-----------|-------|
| QT 65584 | |
| GAL 65585 | |

FIBER INSULATION TAPE

3" X 150'

To seal fiberglass insulation



White craft back tape.

| FIG. NO. | PRICE |
|----------|-------|
| 45395 | |

PVC FITTING TAPE

1 1/2" X 100' WHITE



TO SEAL ZESTON FITTINGS!

| FIG. NO. | PRICE |
|----------|-------|
| 14139 | |

NON ASBESTOS CEMENT FOR BOILERS, FITTINGS, TANKS



WRAP ON

Fiber glass roll

| FIG. NO. | PRICE |
|----------|-------|
| 14142 | |

| SIZE | FIG. NO. | PRICE |
|-------|----------|-------|
| 5 LB | 14140 | |
| 50 LB | 14141 | |

DUCT TAPE

High quality cloth tape with adhesive back



| FIG. NO. | PRICE |
|------------|-------|
| 2X60 16837 | |
| 3X60 35819 | |

WE SELL SOLUTIONS!



GAS RANGE CONNECTORS AND ADAPTERS

RESIDENTIAL

COMMERCIAL

ASK ABOUT SAFETY CABLE!



Gas Appliance Connection - Stainless Steel, IAPMO - ANSI. Meets requirements for inside or outdoor use.

Commercial Gas Connectors - AGA, ANSI, corrugated stainless steel hose covered by stainless braid with smooth plastic covering for easy cleaning. Also ideal for equipment on casters.

| LENGTH | 3/4 FEMALE | PRICE |
|--------|------------|-------|
| 24" | 16738 | |
| 36" | 16743 | |
| 48" | 16750 | |
| 60" | 16761 | |
| 72" | 16765 | |

| SIZE | FIG. NO. |
|--------------|----------|
| 1/2" X 24" | 53281 |
| 1/2" X 36" | 53283 |
| 1/2" X 48" | 53284 |
| 1/2" X 60" | 53285 |
| 3/4" X 24" | 53286 |
| 3/4" X 36" | 53287 |
| 3/4" X 48" | 53288 |
| 3/4" X 60" | 53289 |
| 1" X 24" | 53290 |
| 1" X 36" | 53291 |
| 1" X 48" | 53292 |
| 1" X 60" | 53293 |
| 1 1/4" X 24" | 53294 |
| 1 1/4" X 36" | 53295 |
| 1 1/4" X 48" | 53296 |
| 1 1/4" X 60" | 53297 |

FITTINGS FOR GAS RANGE CONNECTORS

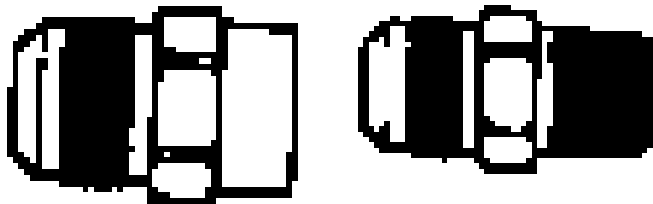

| SIZE | FIG. NO. | PRICE |
|--------------------|----------|-------|
| 1/2 Fem | 16770 | |
| 3/4 Fem | 16778 | |
| 1/2 Male x 3/8 Fem | 16779 | |
| 3/4 Male x 1/2 Fem | 53304 | |



GAS COCKS

GAS QUICK DISCONNECTS

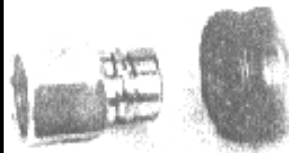
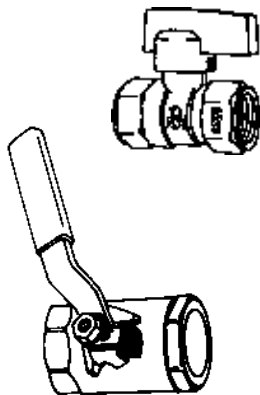

Allows gas appliances to be disconnected quickly and easily automatically shuts off.

GAS REGULATORS

Inlet pressures to 10 PSIG
 Outlet pressures to 2" WC to 2 PSIG
 Please specify your inlet pressure and desired outlet pressure and BTU requirement when ordering.

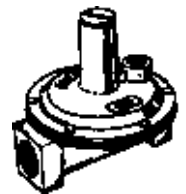

OTHER SIZES AND APPLICATIONS AVAILABLE!

| SIZE | FIG. NO. | PRICE |
|------|----------|-------|
| 1/2 | 39340 | |
| 3/4 | 35991 | |
| 1 | 39341 | |

| SIZE | FIG. NO. | PRICE |
|-------|----------|-------|
| 1/2 | 50802 | |
| 3/4 | 50803 | |
| 1 | 47873 | |
| 1 1/4 | 6349 | |
| 1 1/2 | 6352 | |
| 2 | 49737 | |

| Size | Fig. No. | Price |
|--------|----------|-------|
| 1/2" | 53298 | |
| 3/4" | 53299 | |
| 1" | 53300 | |
| 1 1/4" | 53301 | |

GAS LINE TEFLON TAPE



Yellow gas line teflon thread seal tape. MADE IN USA. 1/2" x 260". Full Density. UL Listed. For use on threaded joints of metal pipe (not exceeding 1-1/2" pipe size) in assemblies handling gasoline, petroleum oils, propane, butane, naphtha, benzene, kerosene and natural gas (pressure no over 100 PSIG). A minimum of two full wraps is required.

| FIG. NO. | PRICE |
|----------|-------|
| 61358 | |

HEATING ACCESSORIES

FIT ALL THERMOCOUPLE KIT

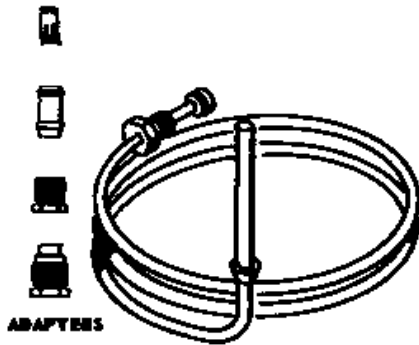

| SIZE | FIG. NO. | PRICE |
|------|----------|-------|
| 18" | 16852 | |
| 24" | 16858 | |
| 36" | 16864 | |

FLOOR AND CEILING PLATES



| COPPER | | | IRON PIPE | | |
|--------|----------|-------|-----------|----------|-------|
| SIZE | FIG. NO. | PRICE | SIZE | FIG. NO. | PRICE |
| 1/2 | 16879 | | 1/2 | 16908 | |
| 3/4 | 16884 | | 3/4 | 16909 | |
| 1 | 16886 | | 1 | 16914 | |
| 1 1/4 | 16894 | | 1 1/4 | 16915 | |
| 1 1/2 | 16899 | | 1 1/2 | 16917 | |
| 2 | 21354 | | 2 | 16922 | |
| | | | 2 1/2 | 16924 | |
| | | | 3 | 16926 | |
| | | | 4 | 16931 | |

4-IN-1 RADIATOR HANDLE



| FIG. NO. | PRICE |
|----------|-------|
| 16794 | |

THERMOCOUPLE TESTER



For quick testing of thermocouple output. Provides visual indication of proper thermocouple operation.

| FIG. NO. | PRICE |
|----------|-------|
| 66260 | |

SELF TAPPING BOILER PLUGS

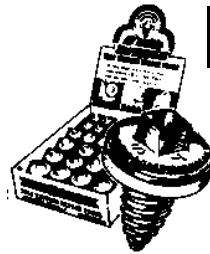

| SIZE | FIG. NO. | PRICE |
|------|----------|-------|
| 1/4 | 16799 | |
| 5/16 | 16804 | |
| 3/8 | 16812 | |
| 7/16 | 16817 | |

ACE BOILER PLUG

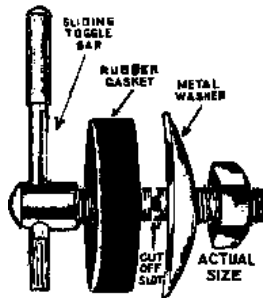

| SIZE | FIG. NO. | PRICE |
|-------|----------|-------|
| STD | 16829 | |
| JUMBO | 16833 | |

FOLDING TANK STICKS



| FIG. NO. | PRICE |
|----------|-------|
| 50412 | |

SEE PAGE 732 FOR WATER FINDING PASTE

TANK STICKS

SEE PAGE 732 FOR WATER FINDING PASTE



| SIZE | FIG. NO. | PRICE |
|-------|----------|-------|
| 9 FT | 25678 | |
| 14 FT | 29220 | |

THERMOSTAT CABLE WITH PLASTIC JACKET



| SIZE | FIG. NO. | PRICE |
|------|----------|-------|
| 18-2 | 8838 | |
| 18-3 | 8845 | |
| 18-4 | 8864 | |
| 18-5 | 8865 | |
| 18-6 | 8867 | |

ELECTRICAL TAPE



| SIZE | FIG. NO. | PRICE |
|----------|----------|-------|
| 3/4 X 60 | 15332 | |

IGNITION CABLE



Fits "Rajah" terminal perfectly. 25 FT to plastic box.

| FIG. NO. | PRICE |
|----------|-------|
| 34312 | |

IGNITORS

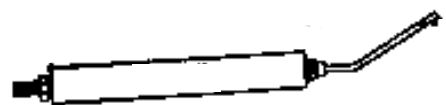

CALL FOR CORRECT SIZING

TOUGH TANK

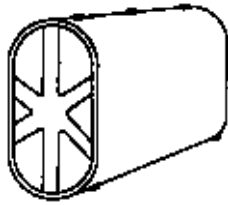

TOUGHTANK for indoor or outdoor use! Exclusive design provides greater structural integrity and weld protection. Withstands internal pressures over 100 psi in actual test without rupture. **WARNING:** Permanent distortion will occur if tanks are operated in excess of normal operating pressure (2 1.2 psi). Tanks bear a UL 80 Label. UL 142 available on request. Designed and fabricated for storage of home heating oil. Tanks are painted with red primer and are available in other colors on request. **LEGS SOLD SEPARATELY.**

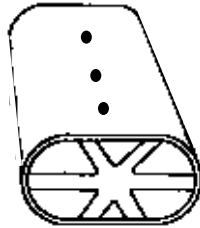

| HORIZONTAL | | | | | | |
|------------|--------|------|------|-------|----------|-------|
| CAP (GAL) | WIDTH | HGHT | LNTH | GAUGE | FIG. NO. | PRICE |
| 275 | 44 1/4 | 27 | 60 | 12 | 47152 | |
| 330 | 44 1/4 | 27 | 72 | 12 | 47153 | |
| 275 | 44 1/4 | 27 | 60 | 14 | 74708 | |

| VERTICAL | | | | | | |
|-----------|-------|---------|------|-------|----------|-------|
| CAP (GAL) | WIDTH | HGHT | LNTH | GAUGE | FIG. NO. | PRICE |
| 275 | 27 | 44 1/4 | 60 | 12 | 47150 | |
| 330 | 27 | 44 1/4 | 72 | 12 | 47151 | |
| 275 | 27 | 44 1/4 | 60 | 14 | 74707 | |
| 230* | 22* | 44 1/4* | 60* | 14* | 18465* | |

*SPECIAL NARROW FOR THOSE TIGHT STAIR WAYS!

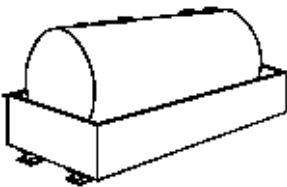

DIKE TANKS
240-30,000 gallon

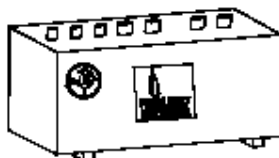

FIREGUARD TANKS
500-12,000 gallon
30 year warranty

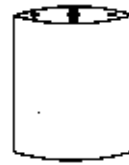

OIL TANKS

14 Gauge steel, finished red primer, UL Listed.
Vertical Heating Fuel Tanks designed to be used in a finished part of the house.

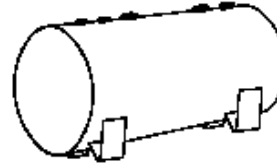

Horizontal Heating Fuel Tanks designed to be used outdoors along side or under mobile homes or in crawl spaces.

| NOM CAP (GAL) | DESCR. | FIG. NO. | DIA | LGTH | PRICE |
|---------------|----------|----------|-----|------|-------|
| 192 | Vertical | 50629 | 28" | 76" | |
| 160 | Vertical | 48892 | 28" | 64" | |
| 240 | Horiz. | 53869 | 28" | 7'6" | |

FUEL HOPPER

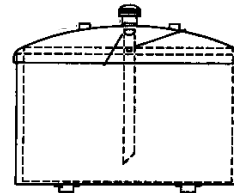

State of the art technology for low profile, above-ground storage. They are suitable for the containment of all types of liquid fuels, new and used oils, waste solvents and anti-freeze.

HAZ HOPPER

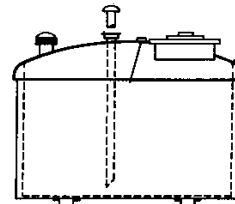

Designed and built to the rigid UL 142 specifications. Consists of an inner tank, placed in the he second tub-like steel container, providing a minimum of 110% secondary containment.

PETRO-HOPPER

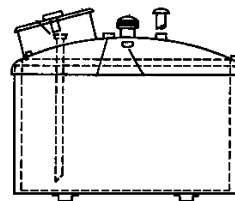

Unique, extended-dome top design, prevents rain, snow and debris from collecting in the secondary containment.

CALL NOW FOR PRICING AND AVAILABILITY

**CALL FOR MANY OTHER APPLICATIONS!
610-275-4553**

SCULLY SYSTEMS

VENTALARM GAUGE

The original whistle alarm.



| SIZE | FIG. NO. | PRICE |
|--------------------|----------|-------|
| 2"x1 1/4", 26"-27" | 9610 | |
| 2"x1 1/4", 42"-44" | 9609 | |
| 2"x1 1/2", 26"-27" | 47592 | |
| 2"x1 1/2", 42"-44" | 47591 | |

ECONO GAUGE

Inexpensive and accurate. Fits 1 1/2" or 2".



| TANK SIZE | FIG. NO. | PRICE |
|-----------|----------|-------|
| 26" - 27" | 9608 | |
| 37" | 49281 | |
| 42" | 9607 | |
| 48" | 49281 | |

SNORKEL GAUGE

Level indicator with floating burner feed line. Fits 1 1/2" or 2". Ideal for mobile homes!



| SIZE | FIG. NO. | PRICE |
|---------|----------|-------|
| 42"-44" | 51480 | |

VENTALARM SIGNAL



| SIZE | FIG. NO. | PRICE |
|----------------|----------|-------|
| 1 1/2"x1 1/4" | 51482 | |
| 2" x 1 1/4" | 9606 | |
| 2" x 1/12" | 9605 | |
| 2" x 2" | 40118 | |
| 2" compression | 47590 | |



ALL WEATHER

LOCKING CAP

This cap fits the top of all Scully straight and 45°

adapters and features a new heavy weight design. Operates with magnetic key.

| FIG. NO. | PRICE |
|----------|-------|
| 58987 | |

GOLDEN GALLON GAUGES



Double float gauge for indoor, outdoor or buried tank. Fits 1 1/2" or 2". Reads in inches.

| SIZE | FIG. NO. | PRICE |
|------|----------|-------|
| 48" | 16452 | |
| 64" | 50613 | |
| 72" | 49280 | |



UNIFILL FITTINGS

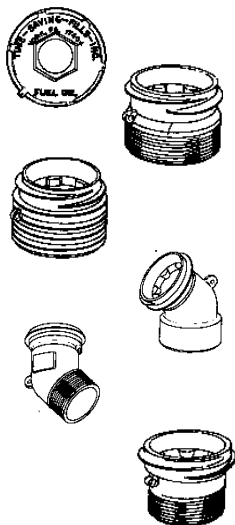

| DESCRIPTION | FIG. NO. | PRICE |
|---------------------------------|----------|-------|
| Cap to fit all Unifill adapters | 44563 | |
| 1 1/2" male straight adapter | 52393 | |
| 2" male straight adapter | 52394 | |
| 1 1/2" female straight adapter | 44564 | |
| 2" female straight adapter | 44565 | |
| 1 1/2" Female 45° adapter | 52332 | |
| 2" Female 45° adapter | 52333 | |
| 1 1/2" Male 45° adapter | 52334 | |
| 2" Male 45° adapter | 44566 | |

FUSIBLE VALVES

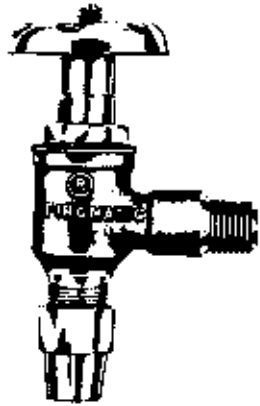

ANGLE VALVE
3/8 OD Flare X 1/4 M

| FIG. NO. | PRICE |
|----------|-------|
| 51171 | |



FEM IP CHECK VALVE
SPRING LOADED
3/8 FIP X 3/4 FIP

| FIG. NO. | PRICE |
|----------|-------|
| 32328 | |

1/2 FIP X 1/2 FIP

| FIG. NO. | PRICE |
|----------|-------|
| 32330 | |



STRAIGHT FLARE
3/8 OD FL X 3/8 OD FL

| FIG. NO. | PRICE |
|----------|-------|
| 32326 | |

1/2 OD FL X 1/2 OD FL

| FIG. NO. | PRICE |
|----------|-------|
| 32327 | |



FLARE CHECK VALVE
SPRING LOADED
3/8 ID FL X 3/8 OD FL

| FIG. NO. | PRICE |
|----------|-------|
| 32329 | |

1/2 OD FL X 1/2 OD FL

| FIG. NO. | PRICE |
|----------|-------|
| 32331 | |



STRAIGHT FEMALE PIPE

3/8" FIP

| FIG. NO. | PRICE |
|----------|-------|
| 32324 | |

1/2" FIP

| FIG. NO. | PRICE |
|----------|-------|
| 32325 | |

3/4" FIP

| FIG. NO. | PRICE |
|----------|-------|
| 51437 | |

OIL SAFETY VALVE

Not Fusible

3/8" FIP

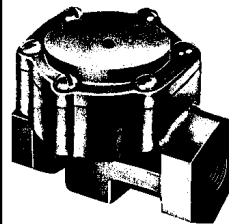

- ∞Relieves pressure strain on fuel pump inlets
- ∞Prevents syphonage of fuel tanks
- ∞Prevents spilling due to accidental line breakage

The OSV is ideal for use in oil supply stems which have from 0 to 60 PSI supply line pressure on the inlet side of the valve, but requires a sustained vacuum on the outlet

side of the valve for the fuel to flow to the burner pump.

3/8" FIP

| FIG. NO. | PRICE |
|----------|-------|
| 48474 | |

1/2" FIP

| FIG. NO. | PRICE |
|----------|-------|
| 48475 | |

FUEL OIL MOTOR/PUMP SUPPLY UNITS

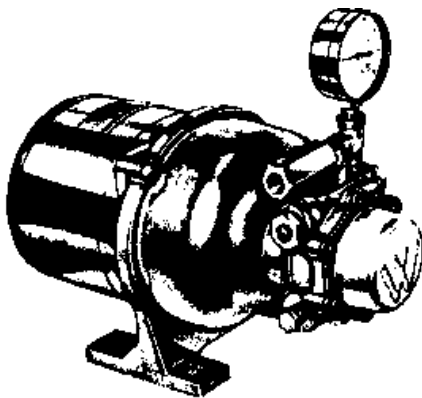

Webster Supply Pump/Motor Units have been developed to supply fuel oil to one or more overhead furnaces, daytanks or for underground central distribution in trailer courts and housing developments.

Four Pump/Motor sizes are available with capacities of 15, 30, 65 and 135 GPH. the units are capable of lifting oil 15 feet from a storage tank and supplying it to furnaces located 200' plus above the pump. A complete unit consists of a pump direct coupled to the motor, a check valve and combination vacuum/pressure gauge. Duplex units are also available completely piped and wired.

CALL NOW FOR YOUR SPECIAL PRICING!

HYDRONIC SPECIALTIES



COPPER
HOT
WATER

RADIATOR VALVE

| SIZE | FIG. NO. | PRICE |
|------|----------|-------|
| 1/2 | 16635 | |
| 3/4 | 16639 | |

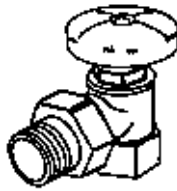

IRON PIPE
HOT WATER
RADIATOR
VALVE

| SIZE | FIG. NO. | PRICE |
|------|----------|-------|
| 1/2 | 16615 | |
| 3/4 | 16618 | |
| 1 | 16620 | |

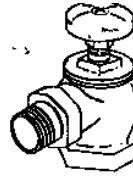

STEAM
RADIATOR
VALVE

| SIZE | FIG. NO. | PRICE |
|-------|----------|-------|
| 1/2 | 16643 | |
| 3/4 | 16647 | |
| 1 | 16652 | |
| 1 1/4 | 16655 | |
| 1 1/2 | 16656 | |
| 2 | 16658 | |

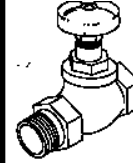

STRAIGHT
RADIATOR
VALVE

| SIZE | FIG. NO. | PRICE |
|-------|----------|-------|
| 1/2 | 16660 | |
| 3/4 | 16666 | |
| 1 | 16671 | |
| 1 1/4 | 16677 | |
| 1 1/2 | 16690 | |

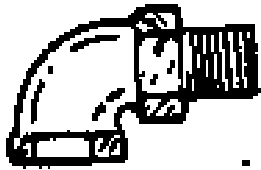

RADIATOR
ELBOW

| SIZE | FIG. NO. | PRICE |
|----------|----------|-------|
| 1/2" IP | 16711 | |
| 3/4" IP | 16716 | |
| 1/2" COP | 16729 | |
| 3/4" COP | 16730 | |



MUSHROOM
VENT
CAP

| SIZE | FIG. NO. | PRICE |
|-------|----------|-------|
| 3/4 | 16427 | |
| 1 | 16428 | |
| 1 1/4 | 9613 | |
| 1 1/2 | 9614 | |
| 2 | 9615 | |
| 3 | 16432 | |
| 4 | 16453 | |



DOUBLE
TAPPED TANK
BUSHING

| SIZE | FIG. NO. | PRICE |
|-----------|----------|-------|
| 2X3/8X3/8 | 9611 | |
| 2X1/2X1/2 | 9612 | |
| 2X5/8X5/8 | 9734 | |



FILL BOX

| SIZE | FIG. NO. | PRICE |
|-------|----------|-------|
| 1 1/2 | 41375 | |
| 2 | 9618 | |
| 3 | 9621 | |
| 4 | 9622 | |



HINGED VENTED
FILL CAP

| SIZE | FIG. NO. | PRICE |
|-------|----------|-------|
| 1 1/2 | 21071 | |
| 2 | 16445 | |
| 3 | 16450 | |
| 4 | 44813 | |

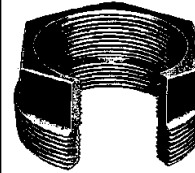

DOUBLE TAPPED
TANK BUSHING

| SIZE | FIG. NO. | PRICE |
|-------------|----------|-------|
| 1X1/2 | 9619 | |
| 1 1/4X1/2 | 9623 | |
| 1 1/4X1 | 9625 | |
| 1 1/2X1 | 9628 | |
| 1 1/2X1 1/4 | 9629 | |
| 2X1/2 | 9630 | |
| 2X3/4 | 9631 | |
| 2X1 | 9632 | |
| 2 X1 1/4 | 9633 | |
| 2X1 1/2 | 9634 | |
| 2 1/2X1 1/4 | 9637 | |
| 2 1/2X1 1/2 | 9638 | |
| 2 1/2 X 2 | 9639 | |
| 3X1 | 9640 | |
| 3X1 1/2 | 9642 | |
| 3X2 | 9643 | |
| 4X2 | 42444 | |
| 4X3 | 38915 | |



MONOFLO
TEE

| SIZE | FIG. NO. | PRICE |
|-----------|----------|-------|
| 3/4X1/2 | 7848 | |
| 1X3/4 | 7852 | |
| 1X1/2 | 7850 | |
| 1 1/4X3/4 | 7862 | |
| 1 1/2X3/4 | 7866 | |
| 1 1/2X1 | 7872 | |
| 2X3/4 | 26910 | |
| 2X1 | 26911 | |

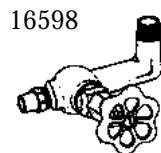

16598

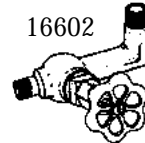

16602

OIL TANK FILTER VALVE
BOTTOM OUTLET

| SIZE | FIG. NO. | PRICE |
|-----------|----------|-------|
| 1/2MX3/8M | 16602 | |
| 1/2MX3/8 | 16598 | |
| OD FL | | |

FUEL AND AIR FILTERS



GENERAL FUEL OIL FILTER

Industry standard for domestic and commercial fuel oil systems. All models feature cast iron filter base with sturdy steel case. Filters are held within the case with a knife-edge seal at top and bottom to insure that nothing bypasses the filter. Cover has air vent port on outlet side.

16454 - For most domestic and light commercial burner systems, maximum firing rate of 10 gph on #2 oil. Uses wool-felt type cartridge.

38831 - For large capacity burner systems, or domestic systems with multiple burners; maximum firing rate of 25 gph on #2 oil. Uses wool-felt type filter cartridge.

33568 - For commercial burner systems; maximum firing rate of 24 gph on #2 fuel oil, 22 gph on #4, #5, #6 oil. Furnished with cleanable 60 mesh monel wire screen element.

| FIG. NO. | PRICE |
|----------|-------|
| 16454 | |
| 38831 | |
| 33568 | |



REPLACEMENT CARTRIDGES FOR GENERAL FUEL FILTERS

"Step Design" wool-felt element furnished as original equipment in 16454 filter. Also, fits Unifilter 77, Autoflo F-300, Sid Harvey XF-25, Eddington S-254 and Federal A77 filters.

| FIG. NO. | PRICE |
|----------|-------|
| 16456 | |
| 32848 | |

REPLACEMENT GASKETS FOR GENERAL FUEL FILTERS

| FIG. NO. | PRICE |
|----------|-------|
| 38832 | |

PUMP STRAINER

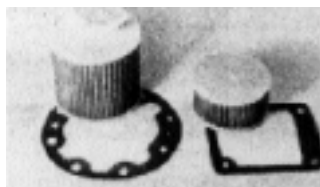

| FOR MODEL 'A' PUMP | |
|---------------------|-------|
| FIG. NO. | PRICE |
| 34304 | |
| FOR MODELS J, H & S | |
| FIG. NO. | PRICE |
| 34303 | |

For additional information call: 610-275-4453 or Fax: 610-279-6299
Please call for current prices.



REPLACEMENT CARTRIDGES FOR FULFLO FUEL FILTERS
Honeycomb filter tubes specially engineered for heating oils give precision, control filtration.

| FIG. NO. | PRICE |
|----------|-------|
| 34306 | |



GAR-BER FUEL FILTER CARTRIDGE

Inline filter with 7 to 10 micron filtering capacity and convenient spin-on cartridge replacement. Superior filtering capability makes this an ideal solution for systems with recurring nozzle clogging problems. Cast aluminum adapter head, resin treated paper filter element.

| FIG. NO. | PRICE |
|----------|-------|
| 82496 | |

REPLACEMENT CARTRIDGE for GAR-BER fuel filter

| FIG. NO. | PRICE |
|----------|-------|
| 42530 | |

REPLACEMENT CARTRIDGE

For general 2A-700 Filter. 100 mesh cleanable. Other sizes and mesh available!



| FIG. NO. | PRICE |
|----------|-------|
| 82771 | |

CALL DUFF FIRST!
610-275-4453

OIL BURNER NOZZLES



| H O L L O W | | | | S O L I D | | | |
|-------------|-----------|----------|-----------|-----------|-----------|----------|-----------|
| G P H | A N G L E | FIG. NO. | P R I C E | G P H | A N G L E | FIG. NO. | P R I C E |
| .65 | 80 | 16457 | | .65 | 60 | 35878 | |
| .65 | 90 | 16465 | | .65 | 70 | 44076 | |
| .75 | 60 | 16466 | | .65 | 80 | 16526 | |
| .75 | 70 | 16468 | | .75 | 60 | 16528 | |
| .75 | 80 | 16475 | | .75 | 70 | 35879 | |
| .85 | 60 | 16477 | | .75 | 80 | 16530 | |
| .85 | 70 | 16481 | | .85 | 60 | 16531 | |
| .85 | 80 | 16482 | | .85 | 70 | 35880 | |
| 1.00 | 60 | 16485 | | .85 | 80 | 16534 | |
| 1.00 | 70 | 16488 | | 1.00 | 60 | 16536 | |
| 1.00 | 80 | 16489 | | 1.00 | 70 | 35881 | |
| 1.10 | 60 | 35874 | | 1.00 | 80 | 16539 | |
| 1.10 | 70 | 35875 | | 1.10 | 60 | 35882 | |
| 1.10 | 80 | 35876 | | 1.10 | 70 | 35883 | |
| 1.20 | 60 | 16490 | | 1.10 | 80 | 35884 | |
| 1.20 | 70 | 16493 | | 1.20 | 60 | 16540 | |
| 1.20 | 80 | 16496 | | 1.20 | 70 | 44077 | |
| 1.25 | 60 | 16498 | | 1.20 | 80 | 16543 | |
| 1.25 | 70 | 16500 | | 1.25 | 60 | 16546 | |
| 1.25 | 80 | 16502 | | 1.25 | 80 | 16548 | |
| 1.35 | 60 | 16504 | | 1.35 | 60 | 16551 | |
| 1.35 | 80 | 16506 | | 1.35 | 80 | 16554 | |
| 1.50 | 60 | 16509 | | 1.50 | 60 | 16555 | |
| 1.50 | 70 | 44075 | | 1.50 | 80 | 16558 | |
| 1.50 | 80 | 16511 | | 1.65 | 60 | 16560 | |
| 1.65 | 60 | 16514 | | 1.65 | 80 | 16563 | |
| 1.65 | 80 | 16517 | | 1.75 | 60 | 16564 | |
| 1.75 | 60 | 35877 | | 1.75 | 80 | 16565 | |
| 1.75 | 80 | 16520 | | 2.00 | 60 | 16567 | |
| 2.00 | 60 | 16522 | | 2.00 | 80 | 16569 | |
| 2.00 | 80 | 16523 | | 3.00 | 80 | 16571 | |
| | | | | 3.50 | 60 | 53805 | |

CONVERSION CHART

CONVERSION FACTORS

| MULTIPLY | BY | TO OBTAIN |
|---------------------------|-----------------------|-------------------|
| Atmospheres (680) | | |
| 760 MM of Mercury at 32°F | 14.696 | Lbs./sq. inch |
| Atmospheres | 76.0 | Cms. of mercury |
| Atmospheres | 29.92 | In. of mercury |
| Atmospheres | 33.90 | Feet of water |
| Atmospheres | 1.0333 | Kgs./sq. cm. |
| Atmospheres | 14.70 | Lbs./sq. inch |
| Atmospheres | 1.058 | Tons/sq. ft. |
| Brit. Therm. Units | 0.2520 | Kilogram-calories |
| Brit. Therm. Units | 777.5 | Foot-lbs. |
| Brit. Therm. Units | 0.000393 | Horse-power-hrs. |
| Brit. Therm. Units | 0.293 | Watt-hrs. |
| BTU/min. | 12.96 | Foot-lbs./sec. |
| BTU/min. | 0.02355 | Horse-power |
| BTU/min. | 0.01757 | Kilowatts |
| BTU/min. | 17.57 | Watts |
| Calorie | 0.003968 | BTU |
| Centimeters | 0.3937 | Inches |
| Centimeters | 0.03280 | Feet |
| Centimeters | 0.01 | Meters |
| Centimeters | 10 | Millimeters |
| Centims. of Merc. | 0.01316 | Atmospheres |
| Centims. of merc. | 0.4461 | Feet of water |
| Centims. of merc. | 135.0 | Kgs./sq. meter |
| Centims. of merc. | 27.85 | Lbs./sq. ft. |
| Centims. of merc. | 0.1934 | Lbs./sq. inch |
| Cubic feet | 2.832x10 ⁴ | Cubic cms. |
| Cubic feet | 1728 | Cubic inches |
| Cubic feet | 0.02832 | Cubic meters |
| Cubic feet | 0.03704 | Cubic yards |
| Cubic feet | 7.48052 | Gallons U.S. |
| Cubic feet/minute | 472.0 | Cubic cms./min. |
| Cubic feet/minute | 0.1247 | Gallons/sec. |
| Cubic feet water | 62.4 | Pounds @ 60°F. |
| Foot | 30.48 | Centimeters |
| Foot | 12 | Inches |
| Foot | 0.3048 | Meters |
| Foot | 1/3 | Yards |

| MULTIPLY | BY | TO OBTAIN |
|----------------------|----------|--------------------|
| Foot of water | 0.02950 | Atmospheres |
| Foot of water | 0.8826 | Inches of mercury |
| Foot of water | 0.03048 | Kgs./sq. cm. |
| Foot of water | 62.43 | Lbs./sq. ft. |
| Foot of water | 0.4333 | Lbs./sq. inch |
| Foot/min. | 0.5080 | Centimeters/sec. |
| Foot/min. | 0.01667 | Feet/sec. |
| Foot/min. | 0.01829 | Meters/hr. |
| Foot/min. | 0.3048 | Meters/min. |
| Foot/min. | 0.01196 | Miles/hr. |
| Foot-pounds | 0.001285 | BTU |
| Gallons | 3785 | Cu. centimeters |
| Gallons | 0.1337 | Cubic feet |
| Gallons | 231 | Cubic inches |
| Gallons | 128 | Fluid ounces |
| Gallons | 3.785 | Liters |
| Gallons water | 8.35 | Lbs. water @ 60°F. |
| Horse-power | 42.44 | BTU/min. |
| Horse-power | 33,000 | Foot-lbs./min. |
| Horse-power | 550 | Foot-lbs./sec. |
| Horse-power | 0.7457 | Kilowatts |
| Horse-power | 745.7 | Watts |
| Horse-power (boiler) | 23,479 | BTU/hr. |
| Horse-power (boiler) | 9,803 | Kilowatts |
| Horse-power-hours | 2547 | BTU |
| Horse-power-hours | 0.7457 | Kilowatt-hours |
| Inches | 2.540 | Centimeters |
| Inches | 25.4 | Millimeters |
| Inches | 0.0254 | Meters |
| Inches | 0.0833 | Foot |
| Inches of mercury | 0.03342 | Atmospheres |
| Inches of mercury | 1.133 | Feet of water |
| Inches of mercury | 13.57 | Inches of water |
| Inches of mercury | 70.73 | Lbs./sq. ft. |
| Inches of mercury | 0.4912 | Lbs./sq. inch |
| Inches of water | 0.002458 | Atmospheres |
| Inches of water | 0.07355 | In. of mercury |
| Inches of water | 0.5781 | Ounces/sq. inch |
| Inches of water | 5.202 | Lbs./sq. foot |
| Inches of water | 0.03613 | Lbs./sq. inch |
| Kilowatts | 56.92 | BTU/min. |
| Kilowatts | 1.341 | Horse-power |
| Kilowatts | 1000 | Watts |
| Kilowatt-hours | 3415 | BTU |

| MULTIPLY | BY | TO OBTAIN |
|--------------------|----------|------------------|
| Liters | 0.2642 | Gallons |
| Liters | 2.113 | Pints (U.S.) |
| Liters | 1.057 | Quarts (U.S.) |
| Meters | 100 | Centimeters |
| Meters | 3.281 | Feet |
| Meters | 39.37 | Inches |
| Meters | 1000 | Millimeters |
| Meters | 1.094 | Yards |
| Ounces (fluid) | 1.805 | Cubic inches |
| Ounces (fluid) | 0.02957 | Liters |
| Ounces/sq. inch | 0.0625 | Lbs./sq. inch |
| Ounces/sq. inch | 1.73 | Inches of water |
| Pints | 0.4732 | Liter |
| Pounds (avoird.) | 16 | Ounces |
| Pounds of water | 0.01602 | Cubic feet |
| Pounds of water | 27.68 | Cubic inches |
| Pounds of water | 0.1198 | Gallons |
| Pounds/sq. foot | 0.01602 | Feet of water |
| Pounds/sq. foot | 0.006945 | Pounds/sq. inch |
| Pounds/sq. inch | 0.06804 | Atmospheres |
| Pounds/sq. inch | 2.307 | Feet of water |
| Pounds/sq. inch | 2.036 | In. of mercury |
| Pounds/sq. inch | 27.68 | Inches of water |
| Temp. (°F) + 273 | 1 | Abs. temp. (°C) |
| Temp. (°C) + 17.78 | 1.8 | Temp. (°F) |
| Temp. (°F) + 450 | 1 | Abs. temp. (°F) |
| Temp. (°F) - 32 | 5/9 | Temp. (°C) |
| Therm. | 100,000 | BTU |
| Tons (long) | 2240 | Pounds |
| Ton, Refrigeration | 12,000 | BTU/hr. |
| Tons (short) | 2000 | Pounds |
| Watts | 3.415 | BTU |
| Watts | 0.05692 | BTU/min. |
| Watts | 44.28 | Foot-pounds/min. |
| Watts | 0.7376 | Foot-pounds/sec. |
| Watts | 0.001341 | Horse-power |
| Watts | 0.001 | Kilowatts |
| Watt-hours | 3.415 | BTU/hr. |
| Watt-hours | 2655 | Foot-pounds |
| Watt-hours | 0.001341 | Horse-power hrs. |
| Watt-hours | 0.001 | Kilowatt-hours |

| BTU INPUT | DRILL SIZE | | | | | | DRILL SIZE | | | | | | |
|-----------|-------------|-----|------|--------|-----|----|-------------|-------|------|--------|-------|------|----|
| | NATURAL GAS | | | LP GAS | | | NATURAL GAS | | | LP GAS | | | |
| | 3" | 4" | 6" | 3" | 4" | 6" | 3" | 4" | 6" | 3" | 4" | 6" | |
| 10,000 | 51 | 52 | 1/16 | 53 | 54 | 62 | 85,000 | 17 | 19 | 20 | 5/32 | 28 | 39 |
| 12,000 | 50 | 50 | 51 | 51 | 53 | 59 | 90,000 | 15 | 17 | 19 | 20 | 27 | 38 |
| 14,000 | 48 | 49 | 50 | 50 | 52 | 57 | 95,000 | 13 | 16 | 17 | 18 | 25 | 36 |
| 16,000 | 46 | 46 | 48 | 49 | 51 | 56 | 100,000 | 11 | 14 | 16 | 18 | 24 | 35 |
| 18,000 | 45 | 46 | 47 | 48 | 50 | 55 | 105,000 | 9 | 11 | 13 | 15 | 22 | 34 |
| 20,000 | 44 | 44 | 45 | 46 | 49 | 54 | 110,000 | 7 | 10 | 13 | 15 | 21 | 33 |
| 25,000 | 3/32 | 42 | 43 | 44 | 46 | 53 | 115,000 | 6 | 9 | 11 | 14 | 19 | 32 |
| 30,000 | 3/8 | 40 | 41 | 42 | 44 | 52 | 120,000 | 4 | 7 | 9 | 11 | 18 | 31 |
| 35,000 | 3/8 | 36 | 38 | 39 | 42 | 50 | 125,000 | 3 | 5 | 8 | 10 | 16 | 28 |
| 40,000 | 31 | 33 | 36 | 36 | 41 | 48 | 130,000 | 7/32 | 4 | 13/64 | 9 | 16 | 28 |
| 45,000 | 50 | 1/8 | 32 | 33 | 38 | 47 | 140,000 | #1 | 7/32 | 3 | 6 | 14 | 30 |
| 50,000 | 29 | 30 | 1/8 | 31 | 36 | 46 | 150,000 | 15/64 | #1 | 7/32 | 3 | 3/16 | 29 |
| 55,000 | 28 | 29 | 30 | 30 | 34 | 44 | 175,000 | 1/4 | C | 15/64 | #1 | 6 | 27 |
| 60,000 | 26 | 28 | 29 | 30 | 34 | 44 | 200,000 | H | F | 1/4 | C | 7/32 | 23 |
| 65,000 | 24 | 26 | 28 | 29 | 1/8 | 43 | 225,000 | L | J | 17/64 | F | A | 19 |
| 70,000 | 22 | 24 | 26 | 28 | 30 | 42 | 250,000 | N | L | K | I | C | 17 |
| 75,000 | 20 | 22 | 24 | 26 | 30 | 42 | 275,000 | O | N | M | 9/32 | F | 14 |
| 80,000 | 18 | 20 | 22 | 24 | 29 | 40 | 300,000 | 21/64 | O | N | 19/64 | H | 10 |

K Factor .82
 Calculation Based on Natural-1050 BTU Gas—0.65 Spec. Gr./LP-2500 BTU Gas—1.55 Spec. Gr.
 Approximate Sizes based on average data for all orifice types

OHMS LAW EQUATION WHEEL

This wheel shows the equation for calculating any one of the basic factors of electricity - Voltage (E), Amperes (I), Watts (P) or Ohms (R) - when any two of these factors are known. The basic equation shows three equations for solving the unknown. Select the equation appropriate for the factors values. Example: A 240V Watt heater is connected to a 240 Volt circuit. How many Amperes does it draw?
 Solution: Because amperes and volts are given, the formula will be based on the I (Amperes) position of the wheel.
 I = E or 240V ÷ 240V = 240V ÷ 24 Ohms
 I = 10

CONVERSION TABLE FOR WATTS - AMPERES - VOLTS

| WATTS | VOLTAGE (E - Single Phase) | | |
|-------|----------------------------|------|------|
| | 120 | 240 | 277 |
| 100 | 4.2 | 2.4 | 2.1 |
| 150 | 6.3 | 3.6 | 3.2 |
| 200 | 8.3 | 4.8 | 4.3 |
| 250 | 10.4 | 6.0 | 5.4 |
| 300 | 12.5 | 7.2 | 6.5 |
| 350 | 14.6 | 8.4 | 7.6 |
| 400 | 16.7 | 9.6 | 8.7 |
| 450 | 18.8 | 10.8 | 9.8 |
| 500 | 20.8 | 12.0 | 10.9 |
| 550 | 22.9 | 13.2 | 12.0 |

DUFF QUIZ

- How many British thermal units (BTU's) are required to raise one pound of water 1 degree fahrenheit?
 - 212
 - 100
 - 1
 - 513
- One cubic foot of water weighs?
 - 1 lb
 - 8.33 lbs
 - 7.48 lbs
 - 62.4 lbs
- One gallon of water weighs?
 - 1 lb
 - 8.33 lbs
 - 7.48 lbs
 - 62.4 lbs
- How many gallons are contained in a cubic foot of water?
 - 2.5
 - 3.33
 - 8.33
 - 7.48

- How many BTU's are in 1 kilowatt-hour?
 - 212
 - 3,412
 - 1,000
 - 62.4
- If you mix 180-degree hot water with 40-degree cold water to obtain 140-degree tempered water, what percentage of the mixed water is hot water?
 - 88.3%
 - 71.5%
 - 75.2%
 - 50.0%
- If you have a storage tank that is 30 inches in diameter by 60 inches high, how many gallons of water will the storage tank hold?
 - 183.62
 - 1,800
 - 120.5
 - 100

$$V = 3.142 \times R \times R \times H$$

$$231$$

- How many BTU's are in one cubic foot of natural gas?
 - 212
 - 1,000
 - 2,500
 - 3,200
- How many BTU's are in one cubic foot of propane?
 - 212
 - 1,000
 - 2,500
 - 3,200
- In gas water heaters, scale deposits on the bottom of the water heater insulate the bottom of the water heater from the burner assembly. How much more fuel does a water heater use if it has 1/2 inch of scale on its bottom?
 - 15%
 - 20%
 - 39%
 - 70%

ANSWERS:

1c, 2d, 3b, 4d, 5b, 6b, 7a, 8b, 9c, 10d

THIS IS PROPER PIPING FOR MOST BRANDS OF MIXING VALVES

POWERS EQUIPMENT

MV430 Hydroguard

*Note: On intermittent (flow) domestic water systems, add electric thermostat to stop pump when return water temperature exceeds Hydroguard set point. Locate pump and thermostat after last tap point. Pump should be sized for following capacities:

- 431 Hydroguard - 5 GPM
- 432 Hydroguard - 8 GPM
- 433 Hydroguard - 10 GPM
- 434 Hydroguard - 12 GPM

POWERS
PROCESS CONTROLS
 A UNIT OF MARK CONTROLS CORPORATION

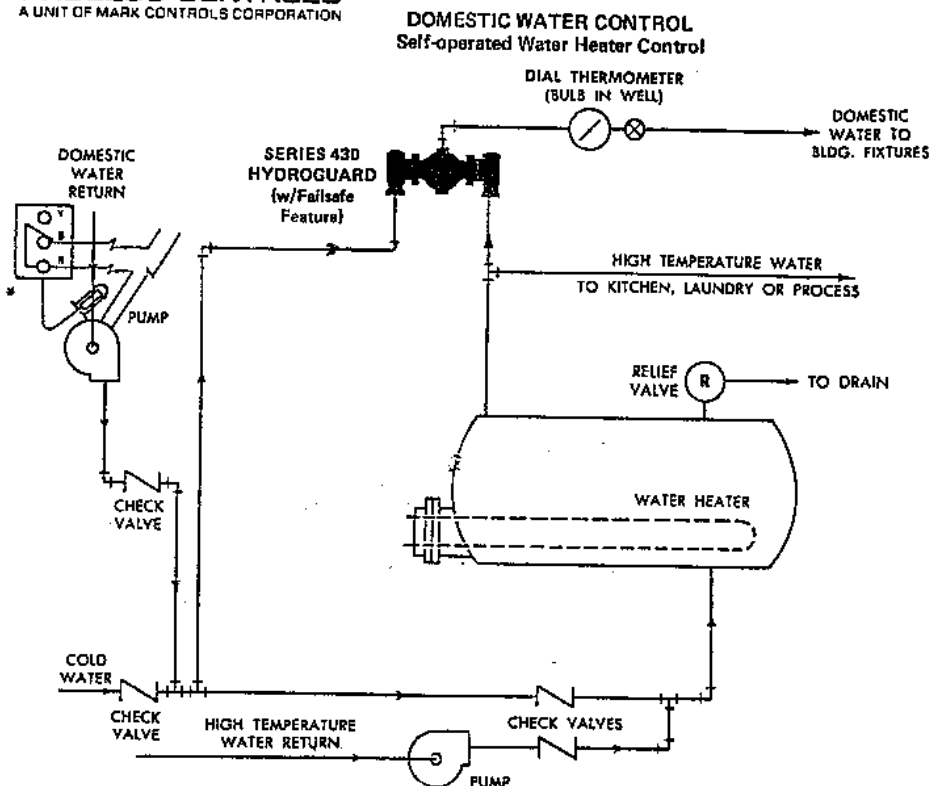

WATER REGULATORS, BACKFLOW PREVENTERS AND METERS

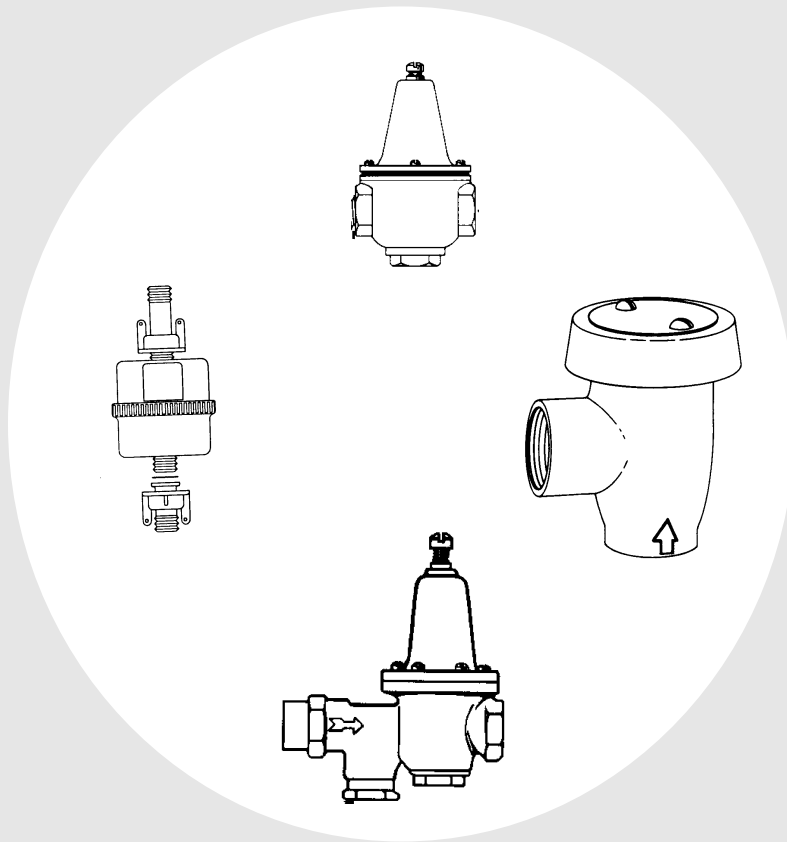

WATER REGULATORS, BACKFLOW PREVENTERS AND METERS

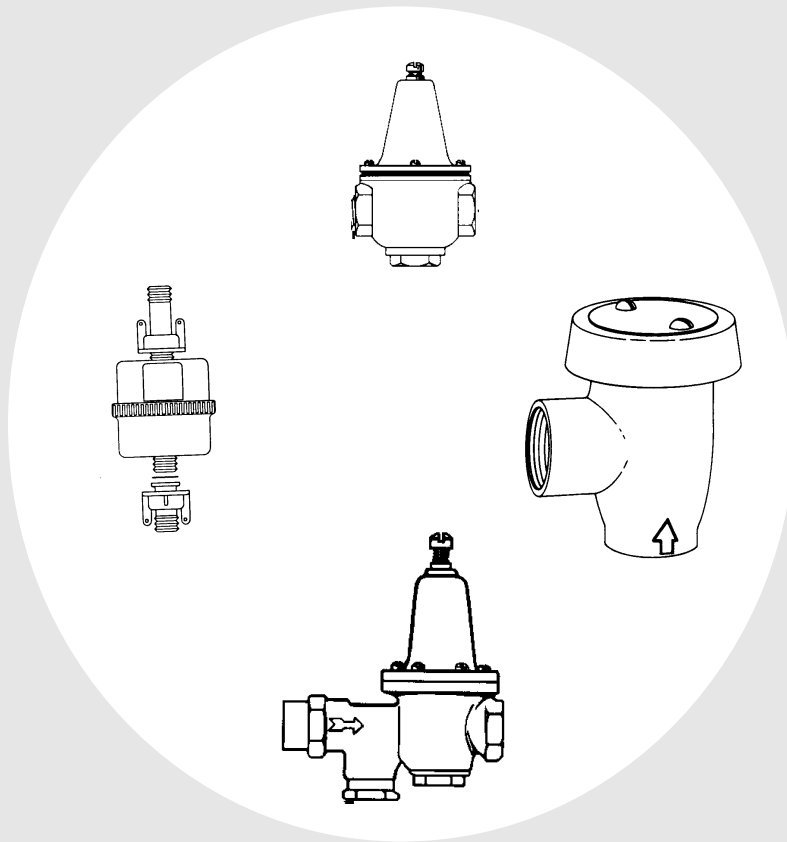

WATTS WATER PRESSURE REDUCING VALVE

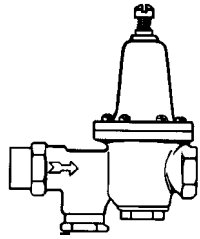

WATTS U5B- Standard capacity water pressure reducing valve with integral strainer. For residential, commercial and industrial applications. Furnished with NPT union inlet and NPT female outlet, for sizes 1/2" through 2". Suitable for initial pressure unless otherwise specified. Max. temp. 160oF. Bronze body con-

struction, Stainless Steel integral strainer, renewable stainless steel seat, high temperature resistant diaphragm. Built-in thermal expansion by-pass equalizing feature to relieve thermal expansion in closed systems.

AVAILABLE - low pressure range - U5BLP 10-35. Set 30 LB 1/2 to 1".

AVAILABLE - high pressure range - U5B HP Range 75-100. Set 90#.

| SIZE | FIG. NO. | PRICE |
|-------|----------|-------|
| 1/2 | 3584 | |
| 3/4 | 4109 | |
| 1 | 3595 | |
| 1 1/4 | 3651 | |
| 1 1/2 | 3655 | |
| 2 | 3661 | |

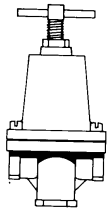

No. 26A WATTS 26A water pressure regulators for water, No. 2 fuel oil and other liquids. Brass body regulators readily meet requirements for beverage dispensing equipment, paint spraying, drinking fountains and many other services. Initial pressures up to 300 lbs. Female inlet and outlet connections. Max temp 140oF.

| SIZE | SET | FIG. NO. | PRICE |
|------|--------|----------|-------|
| 1/8 | 1-25 | 3699 | |
| 1/4 | 1-25 | 76759 | |
| 1/4 | 3-50 | 3705 | |
| 1/4 | 10-125 | 76760 | |
| 3/8 | 1-25 | 76761 | |
| 3/8 | 3-50 | 3709 | |
| 3/8 | 10-125 | 76763 | |
| 1/2 | 1-25 | 76765 | |
| 1/2 | 3-50 | 3712 | |
| 1/2 | 10-125 | 76764 | |

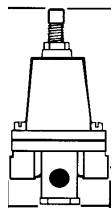

WATTS SS-263AP - Same as above but with stainless steel body and spring cage. Max. temp 120oF. Initial pressure 400 PSI

| SIZE | FIG. NO. | PRICE |
|------|----------|-------|
| 3/8 | 29941 | |
| 1/2 | 29942 | |

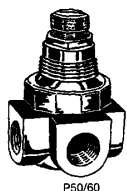

WATTS P50, P60 (1/4") - Suitable to be used with deionized operated equipment. NSF approved grade acetal plastic body. Max supply pressure - 300 PSI. Operating temperature range - 0-150oF. Reduced pressure ranges available: 0-25/0-60/0-125. 1/4 lb.

| FIG. NO. | PRICE |
|----------|-------|
| 45053 | |

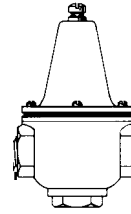

WATTS 223 (1/2" to 2 1/2") N223B (2 1/2", 3") - Super capacity water pressure reducing valves with and without separate strainers. Series 223 and N223B are one of the most experience proven designs available. For commercial, institutional or industrial applications. Initial pressures up to 300 lbs. Reduced pressure range

25-75 lbs. Set for 50 lbs. delivery pressure unless otherwise specified. NPT female inlet and outlet. Max. temperature 160oF. Bronze body.

AVAILABLE - low pressure range 1--35 lbs. Set for 30 lbs unless otherwise specified.

AVAILABLE - high pressure range 1/2", 3/4", 1" 50-145; 1 1/4" 50-120; 1 1/2"-2 1/2", 50-95 lbs.

| SIZE | FIG. NO. | PRICE |
|-------|----------|-------|
| 1/2 | 33112 | |
| 3/4 | 33113 | |
| 1 | 33114 | |
| 1 1/4 | 33115 | |
| 1 1/2 | 33116 | |
| 2 | 33117 | |
| 2 1/2 | 33120 | |

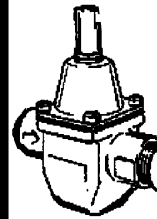

WATTS 123LP - Super sensitive low pressure regulators for water, No. 2 fuel oil and other liquids. Especially engineered for precision regulation and features an extra large diaphragm to assure close control of reduced pressure. Forged, brass body. NPT female inlet and outlet. Initial pressures up to 300 lbs. Max. Temp 120oF. High performance low pressure water regulator. Size 1/2" reduced pressure range 10-30 lbs.

| SIZE | FIG. NO. | PRICE |
|------|----------|-------|
| 1/2" | 21990 | |
| 3/4" | 28384 | |

PILOT OPERATED CONTROL VALVES

For waterworks, commercial, irrigation, fire protection systems and controls.

Watts ACV manufactures automatic control valves to solve a wide variety of fluid control problems. Pacesetting features include our exclusive, positive-closure QUAD-RING SEAT SEAL, a non-edged seat, and a high-protection, FDA Approved, FUSED epoxy finish. In-line maintenance is minimal. Sizes range from 1/4" - 16" globe pattern and 1/4" - 12" angle pattern. End connections in threaded, grooved and flanged. Main valve materials are available in cast iron, ductile iron, steel, aluminum, bronze and aluminum bronze. Pilot operated, diaphragm actuated, the valve is capable of numerous functional combinations within these categories:



CLAY AND MUESCO VALVE ALSO AVAILABLE!

DUFF CO. REGULATORS-BACKFLOWPREVENTERS-METERS

FOUR BASIC TYPES OF BACKFLOW PREVENTERS

| | TYPE & PURPOSE | DESCRIPTION | INSTALLED AT | EXAMPLES |
|----------|---|--|--|--|
| 1 | REDUCED PRESSURE ZONE BACKFLOW PREVENTER For high hazard cross connections and continuous pressure application. | Two independent check valves with intermediate relief valve. Supplied with shut-off valves and ball type test cocks. | All cross-connections subject to backpressure or back siphonage where there is a high potential health contamination. continuous pressure. | Main supply lines Commercial boilers Hospital Equip Lab equipment Waste digesters Car washes |
| | REDUCED PRESSURE DETECTOR ASSY High hazard. | RPZ valve backflow preventers with a water meter and RPZ in by pass line. | Fire protection system supply main. Detects leaks and unauthorized use of water. | Fire Sprinkler Lines |
| 2 | DOUBLE CHECK VALVE ASSEMBLY For low hazard cross connections and continuous pressure applications. | Two independent check valves. Checks are replaceable for repair & testing. | All cross-connections subject to backpressure or back siphonage where there is a low potential health contamination. Continuous pressure. | Main supply lines Food cookers Tanks & vats Lawn sprinklers Fire sprinkler lines Commercial pools |
| | DOUBLE CHECK DETECTOR ASSY Low hazard | Double check valve backflow preventers with a water meter and double check in by pass line. | Fire protection system supply main. Detects leaks and unauthorized use of water. | Fire sprinkler lines |
| | DUAL CHECK VALVE BACKFLOW PREVENTER For low hazard cross-connections. Continuous pressure applications. | Two independent check valves. Checks are replaceable for repair & testing. | Cross connections where there is a low potential health hazard and moderate flow requirements. | Res supply lines (at the meter) Residential fire sprinkler systems |
| 3 | SPECIALTY BACKFLOW PREVENTERS with INTERMEDIATE ATMOSPHERIC VENT For low hazard cross-connections in small pipe sizes. Continuous pressure app. | Two independent check valves with intermediate vacuum breaker and relief vent. | Cross connections subject to backpressure or backsiphonage where there is low health hazard. Continuous pressure. Pressure outlet to prevent backflow of carbon dioxide gas and carbonated water into the water supply system to beverage machines. | Boilers (small) Cooling towers (small) Dairy equipment Post-mix carbonated beverage machine |
| | LABORATORY FAUCET DUAL CHECK VALVE WITH INTERMEDIATE VACUUM BREAKER In small pipe sizes for low hazard. | Two independent check valves with intermediate vacuum breaker and relief vent. | Cross connection subject to backpressure or back siphonage where there is a health hazard. | Lab faucets and pipe lines Barber shop and Beauty parlor sinks |
| | ATMOSPHERIC VACUUM BREAKERS For high hazard cross-connections not subject to continuous pressure - 6" above flood rim. | Single float and disc with large atmospheric port | Cross connection not subject to backpressure or continuous pressure. Install at least 6" above fixture rim. Protection against back siphonage only. | Process tanks dishwashers Soap dispensers Washing machines Lawn sprinklers |
| 4 | PRESSURE VACUUM BREAKERS For high hazard cross-connections. Continuous pressure applications - 12" above flood rim. | Spring loaded single float and disc with independent 1st check. Supplied with shutoff valves and ball type test cocks. | Valve is designed for installation in a continuous pressure potable water supply system 12" above the overflow level of the system being supplied. Protection against backsiphonage only. | Lab equipment Cooling towers Comm laundry Mach Swimming pools Chemical planting tanks Lawn sprinklers |
| | ANTI-SIPHON, ANTI-SPILL VACUUM BREAKER 1" above flood rim factory installed 6" above flood rim field installed | Anti spill vacuum breaker with modular check & float assembly of thermo plastic. Housing bronze body. | Indoor point of use. | Chemical Dispenser Commercial dishwasher Sterilizers |
| | HOSE CONNECTION VACUUM BREAKERS For res. and industrial hose supply outlets not subject to continuous pressure. | Single check with atmospheric vacuum breakers vent. | Install directly on hose bibbs, service sinks and wall hydrants. Not for continuous pressure. | Hose bibbs Service sinks Hydrants |
| | | | | |

| | USC APPROVALS | | AVAILABLE PRODUCT SIZES (INCHES) |
|----------|-------------------|---------------|----------------------------------|
| | SERIES | SIZE (INCHES) | |
| 1 | 009 | 1/4-3 | 1/4-3 |
| | 909 | 3/4-10 | 3/4-10 |
| | 909RPDA | 2 1/2 - 10 | 2 1/2-10 |
| | 993 | - | 4 |
| | 993RPDA | 1/2-3 | 4 |
| 2 | 007 | 2 1/2 - 10 | 1/2-3 |
| | 709 | - | 2 1/2-10 |
| | 773 | 2-3 | 4 |
| | 007DCDA | 3-10 | 2-3 |
| | 709DCDA | - | 3-10 |
| | 773DCDA | - | 4 |
| 3 | 7 | - | 1/2-1 1/4 |
| | 7B | - | 3/4 |
| | A7 | - | 5/8-3/4 |
| | L7 | - | 3/4-1 |
| | 07S | - | 1 |
| | 7C | - | 3/8 |
| 4 | 9DM3/M2, 911 | - | 1/2-3-4 |
| | 98D | - | 3/8FCT |
| | NLF9 | - | 1/4, 3/8 NPTM |
| | N9-CD | - | 3/8 |
| | N9 | - | 3/4 |
| | 288A/289 | 3/4-3 | 1/4, 3/8 |
| | N388 | - | 1/4-3 |
| | 188A | - | 1/4-3/8 |
| | 800MQT | 1/2, 3/4 | 3/4-2 |
| | 800M4QT | 1/2 - 2 | 1/2,3/4 |
| | 008QT | - | 1/2-2 |
| | SBC, 8, NF8, HB-1 | - | 3/8, 1/2, 3/4, 1 |
| | FHB | - | 3/8,1/2, 3/4 HT |
| | TWS | - | 1/2, 3/4 |
| | 07F | - | 3/4, 1 |
| | | | 4-10 |

REDUCED PRESSURE DETECTOR ASSEMBLIES
REDUCED PRESSURE ZONE BACKFLOW PREVENTERS



DOUBLE CHECK VALVE ASSEMBLIES



DOUBLE CHECK DETECTOR ASSEMBLIES

Series 709DCDA



DUAL CHECK VALVE BACKFLOW PREVENTERS

Series 7



Series 07S

SPECIALTY BACKFLOW PREVENTERS
with INTERMEDIATE ATMOSPHERIC VENT



ATMOSPHERIC VACUUM BREAKERS



PRESSURE VACUUM BREAKERS



HOSE CONNECTION VACUUM BREAKERS



DUFF CO. REGULATORS-BACKFLOWPREVENTERS-METERS

HOSE CONNECTORS

 WATTS 8 A- Hose connection vacuum breakers for back-siphonage protection. For potable hoses attached to hose thread faucets. Prevent the flow of contaminated water back into the portable water supply. Furnished with with feature that allows sill cock to be drained - this feature is NON-REMOVABLE.

| FIG. NO. | PRICE |
|----------|-------|
| 8678 | |

WITHOUT DRAINAGE FEATURE

WATTS 8 - Same as 8A except has no non-removable drainage feature.

| FIG. NO. | PRICE |
|----------|-------|
| 8675 | |

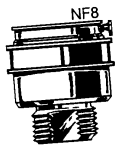

WATTS NF8 - Especially made for wall and yard hydrants. Permits manual draining for freezing conditions.

| FIG. NO. | PRICE |
|----------|-------|
| 8683 | |

ANTI-SIPHON VACUUM BREAKERS

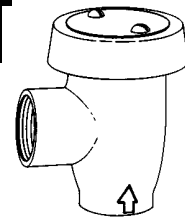
 WATTS 288A ANTI-SIPHON VACUUM BREAKERS for hot or cold water. For health hazard cross connections not subject to continuous pressure - install 6" above highest downstream point of water. Designed to prevent back-siphonage of contaminated water into a potable water supply. Max temperature 160oF at 125 lbs. working pressure. NOT A BACKFLOW PREVENTER.

| SIZE | WEIGHT | FIG. NO. | PRICE |
|--------|--------|----------|-------|
| 1/4" | 3/8 | 8670 | |
| 3/8" | 3/8 | 8660 | |
| 1/2" | 1/2 | 8661 | |
| 3/4" | 1 1/8 | 8662 | |
| 1" | 1 3/4 | 8663 | |
| 1 1/4" | 2 1/8 | 8664 | |
| 1 1/2" | 3 5/8 | 8665 | |
| 2" | 5 1/4 | 8669 | |
| 2 1/2" | 16 | 8667 | |
| 3 | 17 1/8 | 8668 | |

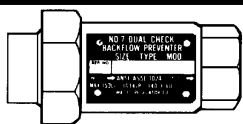

| SIZE | FIG. NO. | PRICE |
|------|----------|-------|
| 1/2" | 48538 | |
| 3/4" | 8717 | |
| 1" | 8720 | |

WATTS 7 - Dual check backflow preventer for water supply service or individual outlets. For non-health hazard continuous pressure applications - Residential system containment. For installation immediately downstream from residential water meters. Horizontal or vertical installation with union end.

WATTS BACKFLOW PREVENTERS



WATTS NFL9 - Laboratory faucet vacuum breaker. Has 3/8" male inlet connections. Fits standard laboratory faucet pipe outlet or gooseneck. Outlet fits standard lab hose nipple or aspirator.

Polished chrome finish. Max pressure 125 psi.

| FIG. NO. | PRICE |
|----------|-------|
| 8686 | |

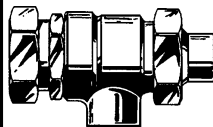

WATTS 9D - Backflow preventer with intermediate atmospheric vent.

For use on hot or cold water and can be used under continuous pressure. For laboratory/dairy equipment, processing tanks, sterilizers, and low hazard applications. For boiler feed lines to prevent backflow when supply pressure falls below system pressure. Female union inlet and outlet connections. May be installed either horizontally or vertically.

| SIZE | FIG. NO. | PRICE |
|------|----------|-------|
| 1/2 | 8711 | |
| 3/4 | 8714 | |

SERIES 288A REPAIR KITS

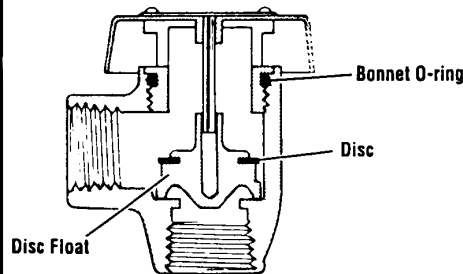

| SIZE | FIG. NO. | PRICE |
|---------|----------|-------|
| 1/4-3/8 | 76675 | |
| 1/2 | 70901 | |
| 3/4-1 | 70902 | |



WATTS N9 - Backflow preventer with atmospheric vent for exposed serviceable installations for in-line continuous pressure applications.

Double check design providing dependable protection against both back-siphonage and backflow. All brass construction.

| SIZE | FIG. NO. | PRICE |
|------|----------|-------|
| 1/4" | 8700 | |
| 3/8" | 8701 | |

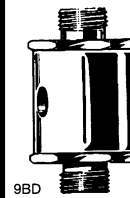

WATTS 9BD - Backflow preventer for vending machine water supply lines. Prevent backflow of carbon dioxide gas and carbonated water into the water supply system. Stainless steel body and internal parts comply with FDA food additive regulations. 3/8" flare.

| FIG. NO. | PRICE |
|----------|-------|
| 8708 | |



WATTS 800M4QT- Anti-siphon pressure vacuum breaker. For health hazard cross connections, continuous pressure applications - install 12" above highest downstream point of water. This valve is designed to prevent back-siphonage of contaminated water into a potable water supply. It is ideal for continuous systems or other continuous pressure piping systems. Working temp 33oF to 140oF - Max pressure 150 psi. Replaceable plastic seat, bronze body and accessory construction, easy in-line maintenance, serves as both anti-siphon and check valve, ball valve test cocks for trouble - free operation.

Working temp 33oF to 140oF - Max pressure 150 psi. Replaceable plastic seat, bronze body and accessory construction, easy in-line maintenance, serves as both anti-siphon and check valve, ball valve test cocks for trouble - free operation.

| SIZE | FIG. NO. | PRICE |
|--------|----------|-------|
| 1/2" | 8652 | |
| 3/4" | 8653 | |
| 1" | 8654 | |
| 1 1/4" | 8655 | |
| 1 1/2" | 8656 | |
| 2" | 8657 | |

WATTS BACKFLOW PREVENTERS

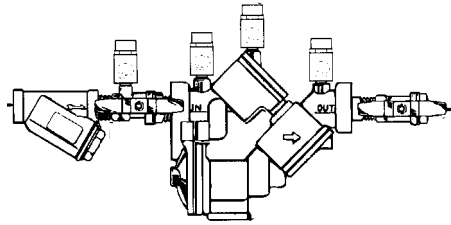

WATTS 909 provides protection in cross-connection control and containment for cold and hot water installations. Furnished with NPT connections

and quarter-turn full port resilient seated bronze ball valve. 175 PSI, 140oF. Bronze body construction, modular design, replaceable seats, ball valve test cocks, easily serviced with no special tools, captured spring assemblies. WITH BRONZE STRAINER.

| SIZE | LENGTH | WGHT W/ STRAINER | FIG. NO. | PRICE |
|--------|---------|---------------------|----------|-------|
| 3/4" | 21 1/4 | 15 5/8 | 8643 | |
| 1 | 22 1/4 | 17 1/2 | 8644 | |
| 1 1/4" | 25 5/8 | 42 3/4 | 8645 | |
| 1 1/2" | 27 3/16 | 44 | 8646 | |
| 2 | 30 3/4 | 473/8 | 8647 | |

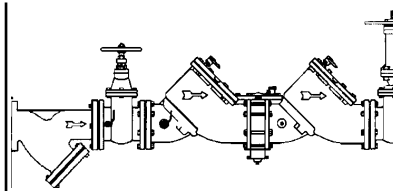

WATTS 909 SIZES 2 1/2" TO 10" Air in/water out principal provides high capacity relief valve discharge.

during the emergency conditions of combined back-siphonage and back pressure with both checks fouled. Epoxy coated cast iron check valve body with bronze seats. 175 psi to 140oF. Removable bronze seats, stainless steel internal parts, easily serviced with no special tools, captured spring assemblies.

| SIZE | LENGTH | WGHT W/ STRAINER | FIG. NO. | PRICE |
|-------|--------|---------------------|----------|-------|
| 2 1/2 | 41 1/4 | 195 | 22778 | |
| 3 | 42 1/4 | 225 | 22777 | |
| 4 | 55 1/8 | 455 | 29948 | |
| 6 | 65 1/2 | 718 | 29949 | |

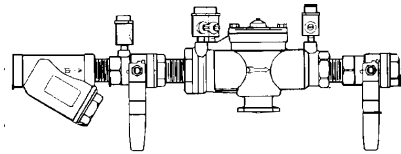

WATTS 009 Protection of the potable water supply. for high hazard cross-connections. For containment at the service line entrance. Two in-

line, independent check valves with an intermediate relief valve. Modular construction, replaceable seats, captured springs, no special tools required for servicing, top access, single cover. WITH BRONZE STRAINER.

| SIZE | LENGTH | WGHT W/ STRAINER | FIG. NO. | PRICE |
|-------|--------|---------------------|----------|-------|
| 1/2 | 13 | 5 1/2 | 61590 | |
| 3/4 | 19 1/4 | 15 | 50517 | |
| 1 | 22 1/2 | 15 1/4 | 51054 | |
| 1 1/4 | 26 5/8 | 31 | 61591 | |
| 1 1/2 | 28 5/8 | 35 | 61592 | |
| 2 | 31 1/2 | 43 | 50518 | |

WATTS 909 90° ELBOW

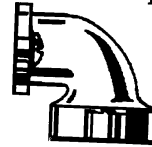

Used with series 909 air gap for connections to 1/2" - 3" backflow preventers on vertical installations.

| SIZE | FIG. NO. | PRICE |
|-------------|----------|-------|
| 3/4" - 1" | 29944 | |
| 1 1/4" - 2" | 29945 | |

WATTS 909 AIR GAP

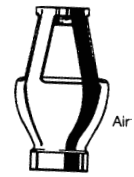

Used with series 909 and 009 series backflow preventers on horizontal installations. Can be easily mounted to body.

| SIZE | FIG. NO. | PRICE |
|-------------|----------|-------|
| 3/4" - 1" | 29943 | |
| 1 1/4" - 3" | 24414 | |
| 4" - 6" | 29946 | |

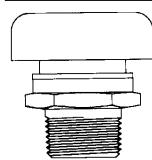

WATTS N36 - Vacuum relief valve for water service. Automatically vents a system if vacuum occurs. Opens at less than 1/2" vacuum. Automatic venting of a closed system to atmosphere when a vacuum is created, thereby, permitting air to enter and prevent vacuum conditions which could siphon the water from the system and burn out a heater or collapse a tank. Also suitable for steam service. Max pressure 15 psi.

| SIZE | WEIGHT | FIG. NO. | PRICE |
|------|--------|----------|-------|
| 1/2" | 3/8 lb | 45181 | |
| 3/4" | 3/4 lb | 45182 | |

WATTS BACKFLOW PREVENTER TEST KIT

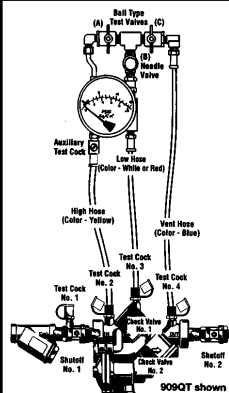

For testing all reduced pressure zone backflow preventers. Accurate testing of "zone" and relief valve opening differential fouled check valves or similar problems that visual inspections cannot locate. 175 psi. 210oF.

| FIG. NO. | PRICE |
|----------|-------|
| 8650 | |

For additional information call: 610-275-4453 or Fax: 610-279-6299
Prices are a guide only. Please call for current prices.

DUFF CO. REGULATORS-BACKFLOWPREVENTERS-METERS

SERIES 909 CHECK VALVES KIT

KIT CONSISTS OF: DISC ASSEMBLY, SPRING, SEAT, SEAT O-RING, COVER O-RING AND LUBRICANT.

WATTS 909 REPAIR KITS

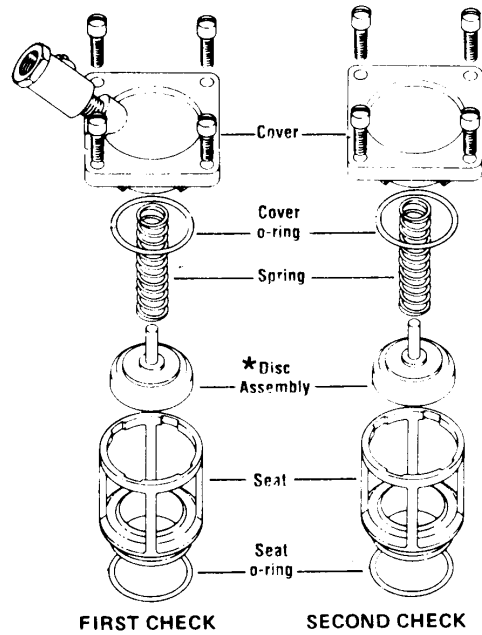
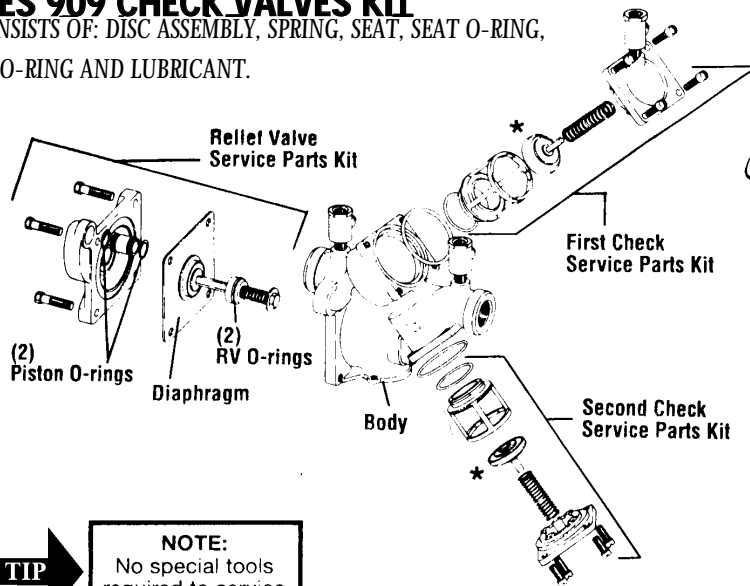

DUFF TIP → **NOTE:**
No special tools required to service Series 909.

*Note: Rubber seat disc can be replaced. However, disc holder and disc retainer are permanently bonded to prevent failure.

FIRST CHECK KITS

| OEM # | KIT # | SIZE | FIG. NO. | PRICE |
|--------|--------------|-------------|----------|-------|
| 887120 | RK 909 CK1 | 3/4" - 1" | 60473 | |
| 887133 | RK 909 CK1 | 1 1/4" - 2" | 60474 | |
| 887122 | RK 909 CK1SS | 3/4" - 1" | 60475 | |
| 887135 | RK 909 CK1SS | 1 1/4" - 2" | 60476 | |

SECOND CHECK KITS

| OEM # | KIT # | SIZE | FIG. NO. | PRICE |
|--------|--------------|-------------|----------|-------|
| 887121 | RK 909 CK2 | 3/4" - 1" | 60477 | |
| 887134 | RK 909 CK2 | 1 1/4" - 2" | 60478 | |
| 887123 | RK 909 CK2SS | 3/4" - 1" | 60479 | |
| 887136 | RK 909 CK2SS | 1 1/4" - 2" | 60480 | |

WHEN ORDERING, PLEASE SPECIFY FIGURE NUMBER AND VALVE SIZE!

SERIES 909 RELIEF VALVE KITS

KIT CONSISTS OF: RELIEF VALVE ASSEMBLY, SEAT, SEAT O-RING, 2 PISTON O-RINGS AND LUBRICANT.

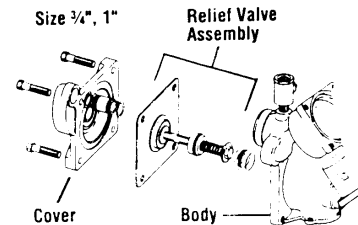

| OEM # | KIT # | SIZE | FIG. NO. | PRICE |
|--------|-----------|-------------|----------|-------|
| 887126 | RK 909 VT | 3/4" - 1" | 60481 | |
| 887138 | RK 909 VT | 1 1/4" - 2" | 60482 | |

WHEN ORDERING, PLEASE SPECIFY FIGURE NUMBER AND VALVE SIZE!

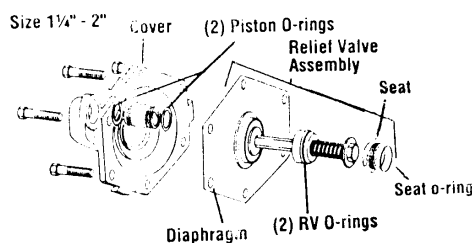

RUBBER GOODS (ONLY) KITS

| OEM # | KIT # | SIZE | FIG. NO. | PRICE |
|--------|----------|-------------|----------|-------|
| 887130 | WRK909RT | 3/4" - 1" | 8648 | |
| 887144 | WRK909RT | 1 1/4" - 2" | 8649 | |

ALL KITS READY FOR IMMEDIATE SHIPMENT!

REDUCED PRESSURE ZONE BACKFLOW PREVENTERS

Series 909 2 1/2" - 10"
Reduced Pressure Zone
Backflow Preventers

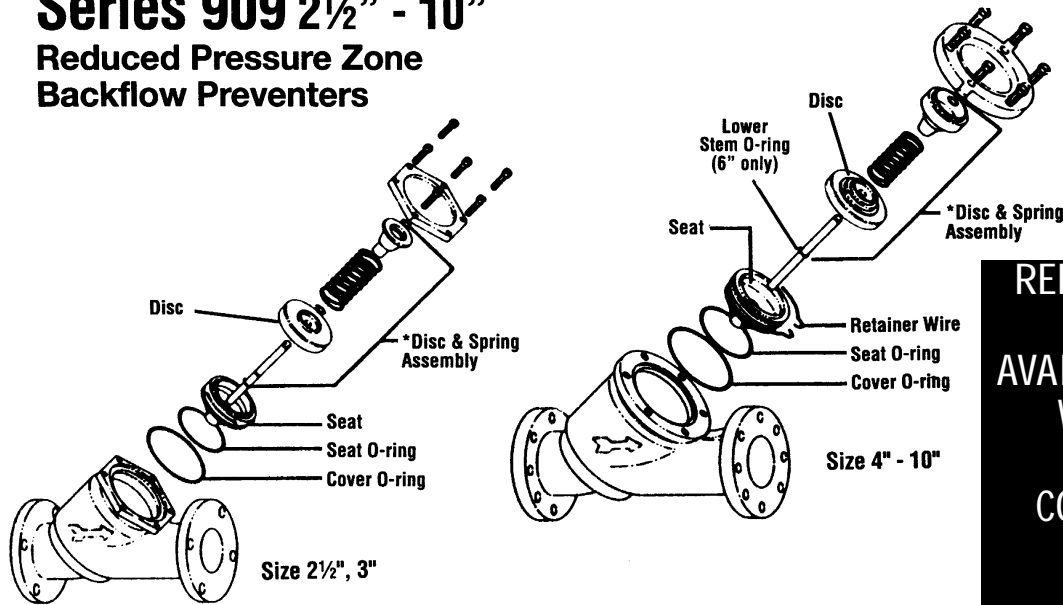

REBUILD KITS
ALSO
AVAILABLE FOR:
WILKINS
ZURN
COMBRACO
FEBCO
HERSEY

CHECK VALVE KITS

When ordering please specify FIG. NO. and VALVE SIZE

| FIG. NO. | KIT NO. | SIZE | PRICE | FIG. NO. | KIT NO. | SIZE | PRICE |
|--|----------|-----------|-------|--|----------|-----------|-------|
| FIRST CHECK KITS: | | | | FIRST CHECK RUBBER PARTS KITS: | | | |
| 85637 | RK909CK1 | 2 1/2"-3" | | 85646 | RK909RC1 | 2 1/2"-3" | |
| 64683 | RK909CK1 | 4" | | 85647 | RK909RC1 | 4" | |
| 85638 | RK909CK1 | 6" | | 85648 | RK909RC1 | 6" | |
| 85639 | RK909CK1 | 8" | | 85649 | RK909RC1 | 8" | |
| 85640 | RK909CK1 | 10" | | 85650 | RK909RC1 | 10" | |
| SECOND CHECK KITS: Kit consists of disc & spring assembly, cover o-ring and lubricant | | | | SECOND CHECK RUBBER PARTS KITS: Kit consists of lower check stem o-ring (6" only), check disc, cover o-ring and lubricant. | | | |
| 64685 | RK909CK2 | 2 1/2"-3" | | 85651 | RK909RC2 | 2 1/2"-3" | |
| 85641 | RK909CK2 | 4" | | 85652 | RK909RC2 | 4" | |
| 85642 | RK909CK2 | 6" | | 85653 | RK909RC2 | 6" | |
| 85643 | RK909CK2 | 8" | | 85654 | RK909RC2 | 8" | |
| 85644 | RK909CK2 | 10" | | 85655 | RK909RC2 | 10" | |
| SEAL KITS Kit consists of seat, set o-ring, cover o-ring, retainer wires and lubricant | | | | COVER KITS FOR CHECKS Kit contains of cover, cover o-ring and lubricant | | | |
| 64688 | RK909CKS | 2 1/2"-3" | | 85668 | RK909C | 2 1/2"-3" | |
| 85656 | RK909CKS | 4" | | 85669 | RK909C | 4" | |
| 85657 | RK909CKS | 6" | | 85671 | RK909C | 6" | |
| 85658 | RK909CKS | 8" | | 85672 | RK909C | 8" | |
| 85659 | RK909CKS | 10" | | 85673 | RK909C | 10" | |

DUFF CO. REGULATORS-BACKFLOWPREVENTERS-METERS

REDUCED PRESSURE ZONE BACKFLOW PREVENTERS

Series 909 2½" - 10" Reduced Pressure Zone Backflow Preventers

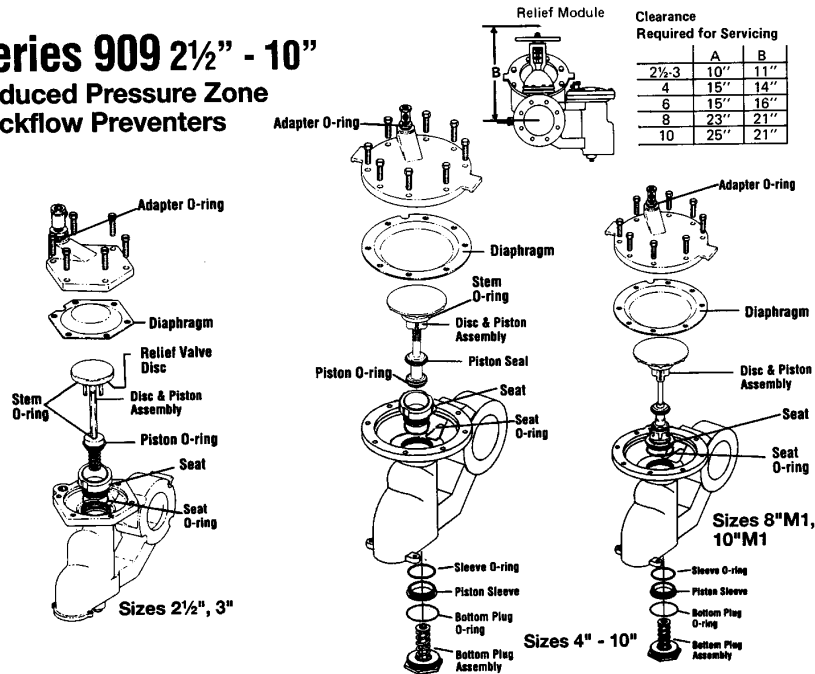

RELIEF VALVE KITS

When ordering please specify FIG. NO. and VALVE SIZE

| FIG. NO. | KIT NO. | SIZE | PRICE |
|--|-----------|-------------|-------|
| RELIEF VALVE RUBBER PARTS Kit consists of sleeve o-ring, piston o-ring, stem o-ring, RV disc assembly, diaphragm, piston seal, bottom plug o-ring, adapter o-ring and lubricant. | | | |
| 85660 | RK909RV | 2 1/2" - 3" | |
| 85661 | RK909RV | 4" - 6" | |
| 85662 | RK909RV | 8" - 10" | |
| 85663 | RK909M1RV | 4" - 10" | |
| RELIEF VALVE TOTAL Kit consists of diaphragm, disc & piston assembly, seat, seat o-ring, adapter o-ring and lubricant (sizes 4" -10" M1 includes bottom plug & spring assembly). | | | |
| 64689 | RK909VT | 2 1/2" - 3" | |
| 85665 | RK909VT | 4" - 6" | |
| 85666 | RK909VT | 8" - 10" | |
| 85667 | RK909M1VT | 4" - 10" | |
| TOTAL RUBBER PARTS KITS Kit consists of lower check stem o-ring (6" only), check disc, cover o-ring, sleeve o--ring, piston o-ring, RV disc assembly, diaphragm, piston seal and lubricant. | | | |
| 85704 | RK909RT | 2 1/2" - 3" | |
| 63072 | RK909RT | 4" | |
| 85705 | RK909RT | 6" | |
| 85706 | RK909RT | 8" | |
| 85708 | RK909M1RT | 8" | |
| 85707 | RK909RT | 10" | |
| 85709 | RK909M1RT | 10" | |

REGULATORS-BACKFLOWPREVENTERS-METERS DUFF CO.

DOLE FLOW REGULATORS (CHROME PLATED BRASS)

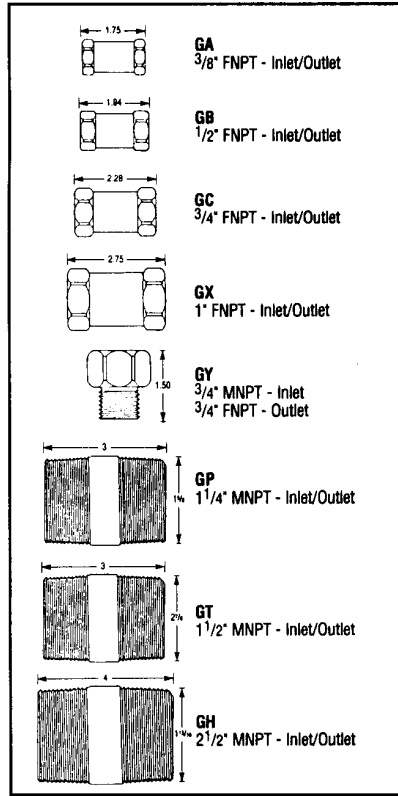

| Flow Rate in GPM | GA | GB | GC | GY | GX | GP | GT | GH |
|------------------|----|----|----|----|----|----|----|----|
| 0.06 | ✓ | | | | | | | |
| 0.13 | ✓ | | | | | | | |
| 0.19 | ✓ | | | | | | | |
| 0.25 | ✓ | | | | | | | |
| 0.35 | ✓ | | | | | | | |
| 0.50 | ✓ | | | | | | | |
| 0.60 | ✓ | | | | | | | |
| 0.75 | ✓ | | | | | | | |
| 1.00 | ✓ | | | | | | | |
| 1.50 | ✓ | ✓ | | | | | | |
| 1.60 | ✓ | ✓ | | | | | | |
| 1.75 | ✓ | ✓ | | | | | | |
| 2.00 | ✓ | ✓ | ✓ | | | | | |
| 2.60 | ✓ | ✓ | ✓ | ✓ | | | | |
| 3.00 | ✓ | ✓ | ✓ | ✓ | ✓ | | | |
| 3.50 | ✓ | ✓ | ✓ | ✓ | ✓ | ✓ | | |
| 4.00 | ✓ | ✓ | ✓ | ✓ | ✓ | ✓ | | |
| 4.50 | ✓ | ✓ | ✓ | ✓ | ✓ | ✓ | | |
| 5.00 | ✓ | ✓ | ✓ | ✓ | ✓ | ✓ | | |
| 5.50 | ✓ | ✓ | ✓ | ✓ | ✓ | ✓ | | |
| 6.25 | ✓ | ✓ | ✓ | ✓ | ✓ | ✓ | | |
| 7.00 | ✓ | ✓ | ✓ | ✓ | ✓ | ✓ | | |
| 8.20 | ✓ | ✓ | ✓ | ✓ | ✓ | ✓ | | |
| 8.30 | ✓ | ✓ | ✓ | ✓ | ✓ | ✓ | | |
| 9.00 | ✓ | ✓ | ✓ | ✓ | ✓ | ✓ | | |
| 10.00 | ✓ | ✓ | ✓ | ✓ | ✓ | ✓ | | |
| 11.50 | ✓ | ✓ | ✓ | ✓ | ✓ | ✓ | | |
| 12.00 | ✓ | ✓ | ✓ | ✓ | ✓ | ✓ | | |
| 13.50 | ✓ | ✓ | ✓ | ✓ | ✓ | ✓ | | |
| 15.00 | ✓ | ✓ | ✓ | ✓ | ✓ | ✓ | | |
| 20.00 | ✓ | ✓ | ✓ | ✓ | ✓ | ✓ | | |
| 25.00 | ✓ | ✓ | ✓ | ✓ | ✓ | ✓ | | |
| 30.00 | ✓ | ✓ | ✓ | ✓ | ✓ | ✓ | | |
| 35.00 | ✓ | ✓ | ✓ | ✓ | ✓ | ✓ | | |
| 40.00 | ✓ | ✓ | ✓ | ✓ | ✓ | ✓ | | |
| 45.00 | ✓ | ✓ | ✓ | ✓ | ✓ | ✓ | | |
| 50.00 | ✓ | ✓ | ✓ | ✓ | ✓ | ✓ | | |
| 55.00 | ✓ | ✓ | ✓ | ✓ | ✓ | ✓ | | |
| 60.00 | ✓ | ✓ | ✓ | ✓ | ✓ | ✓ | | |
| 65.00 | ✓ | ✓ | ✓ | ✓ | ✓ | ✓ | | |
| 70.00 | ✓ | ✓ | ✓ | ✓ | ✓ | ✓ | | |
| 75.00 | ✓ | ✓ | ✓ | ✓ | ✓ | ✓ | | |
| 80.00 | ✓ | ✓ | ✓ | ✓ | ✓ | ✓ | | |
| 85.00 | ✓ | ✓ | ✓ | ✓ | ✓ | ✓ | | |
| 90.00 | ✓ | ✓ | ✓ | ✓ | ✓ | ✓ | | |

| FIG. NO. | MODEL NO. | SIZE | FLOW GALLONS | PRICE | FIG. NO. | MODEL NO. | SIZE | FLOW GALLONS | PRICE |
|----------|-----------|------|--------------|-------|----------|-----------|--------|--------------|-------|
| 8734 | GA006 | 3/8" | 1/16 | | 30940 | GY4.50 | 3/4" | 4 1/2 | |
| 8737 | GA013 | 3/8" | 1/8 | | 30941 | GY5 | 3/4" | 5 | |
| 30957 | GA019 | 3/8" | 1/5 | | 40146 | GY5.50 | 3/4" | 5 1/2 | |
| 8740 | GA025 | 3/8" | 1/4 | | 30942 | GY6 | 3/4" | 6 | |
| 30903 | GA035 | 3/8" | 1/3 | | 30943 | GY7 | 3/4" | 7 | |
| 8743 | GA050 | 3/8" | 1/2 | | 30944 | GY8 | 3/4" | 8 | |
| 51954 | GA060 | 3/8" | 2/3 | | 30945 | GY9 | 3/4" | 9 | |
| 8744 | GA0.75 | 3/8" | 3/4 | | 30946 | GY10 | 3/4" | 10 | |
| 8745 | GA1.1 | 3/8" | 1 | | 30947 | GY11.50 | 3/4" | 11 1/2 | |
| 30919 | GB1.1 | 1/2" | 1 | | 30948 | GX1 | 1" | 1 | |
| 8747 | GB1.50 | 1/2" | 1 1/2 | | 30949 | GX1.50 | 1" | 1 1/2 | |
| 8750 | GB2 | 1/2" | 2 | | 30950 | GX2 | 1" | 2 | |
| 8753 | GB2.50 | 1/2" | 2 1/2 | | 8770 | TX2.50 | 1" | 2 1/2 | |
| 8755 | GB3 | 1/2" | 3 | | 8773 | GX3 | 1" | 3 | |
| 8757 | GB3.50 | 1/2" | 3 1/2 | | 8776 | GX3.50 | 1" | 3 1/2 | |
| 8760 | GB4 | 1/2" | 4 | | 8778 | GX4.1 | 1" | 4 | |
| 30920 | GB4.50 | 1/2" | 4 1/2 | | 8780 | GX4.50 | 1" | 4 1/2 | |
| 30921 | GB5 | 1/2" | 5 | | 8783 | GX5.0 | 1" | 5 | |
| 30922 | GB5.50 | 1/2" | 5 1/2 | | 30951 | TX5.50 | 1" | 5 1/2 | |
| 30923 | GB6.0 | 1/2" | 6 | | 8784 | GX6 | 1" | 6 | |
| 30924 | GC1 | 3/4" | 1 | | 8786 | GX7 | 1" | 7 | |
| 30925 | GC1.50 | 3/4" | 1 1/2 | | 8788 | GX8 | 1" | 8 | |
| 30926 | GC2 | 3/4" | 2 | | 8790 | GX9 | 1" | 9 | |
| 30927 | GC2.50 | 3/4" | 2 1/2 | | 8793 | GX10 | 1" | 10 | |
| 30928 | GC3 | 3/4" | 3 | | 8795 | GX12 | 1" | 12 | |
| 30929 | GC3.50 | 3/4" | 3 1/2 | | 30952 | GX13.50 | 1" | 13 1/2 | |
| 30930 | GC4.1 | 3/4" | 4 | | 8798 | GX15 | 1" | 15 | |
| 30931 | GC4.50 | 3/4" | 4 1/2 | | 8801 | GX20 | 1" | 20 | |
| 32543 | GC5.0 | 3/4" | 5 | | 8803 | GX25 | 1" | 25 | |
| 30923 | GC5.50 | 3/4" | 5 1/2 | | 8806 | GX30 | 1" | 30 | |
| 8764 | GC6 | 3/4" | 6 | | 40147 | GH30 | 2 1/2" | 30 | |
| 8765 | GC7 | 3/4" | 7 | | 8807 | GH35 | 2 1/2" | 35 | |
| 8766 | GC8 | 3/4" | 8 | | 8809 | GX40 | 2 1/2" | 40 | |
| 8767 | GC9 | 3/4" | 9 | | 8812 | GH45 | 2 1/2" | 45 | |
| 8768 | GC10 | 3/4" | 10 | | 8818 | GH50 | 2 1/2" | 50 | |
| 30933 | GC11.5 | 3/4" | 11 1/2 | | 8819 | GH55 | 2 1/2" | 55 | |
| 8769 | GY1 | 3/4" | 1 | | 8821 | GH60 | 2 1/2" | 60 | |
| 30934 | GY1.50 | 3/4" | 1/2 | | 30953 | GH65 | 2 1/2" | 65 | |
| 30935 | GY2 | 3/4" | 2 | | 8823 | GH70 | 2 1/2" | 70 | |
| 30936 | GY2.50 | 3/4" | 2 1/2 | | 30954 | GH75 | 2 1/2" | 75 | |
| 30937 | GY3 | 3/4" | 3 | | 8826 | GH80 | 2 1/2" | 80 | |
| 30938 | GY3.50 | 3/4" | 3 1/2 | | 30955 | GH85 | 2 1/2" | 85 | |
| 30939 | GY4 | 3/4" | 4 | | 8828 | GH90 | 2 1/2" | 90 | |

For additional information call: 610-275-4453 or Fax: 610-279-6299
 Prices are a guide only. Please call for current prices.

DUFF CO. REGULATORS-BACKFLOWPREVENTERS-METERS

DUFF FLOW REGULATORS - ASSEMBLED TO YOUR SPECIFICATIONS

Duff offers a wide range of flow controls that are ideal for use in private homes and buildings.

Water flow rate can be equalized throughout the home or building by installing a Flo-et at the inlet to each appliance. And, water usage can be reduced substantially by controlling the volume of water used in sinks, showers and drinking fountains.

Flo-et flow controls can be incorporated into in-line housings for specific contact time with point-of-use water filters.

Residential and light commercial flo-et flow controls are available in flow rates form 1/4 to 20 gpm. For temperatures less than 140°.

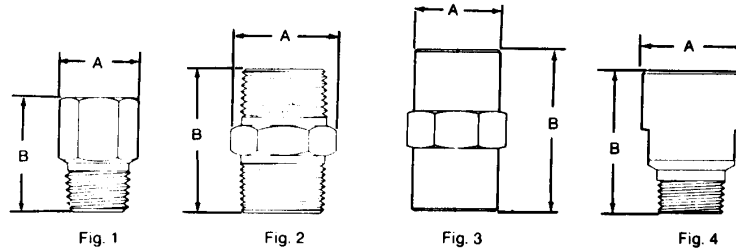

| Order No. | Description | Available Flow Rates | Pipe Size | A In. (mm) | B In. (mm) | Flow Direction | Housing Material | Figure |
|-----------|-----------------------------|----------------------|-----------|----------------------|-----------------|----------------|-------------------------------------|--------|
| 56161 | #77-19 3/8" B Flo-Control | .25 - 3.5 gpm | 3/8" | 3/4" Hex (19.1mm) | 1-1/4" (31.8mm) | F—M, M—F | Brass | 1 |
| | #80-23 3/8" P Flo-Control | .25 - 4.0 gpm | 3/8" | 13/16" Hex (20.8mm) | 1-1/2" (38.1mm) | F—F | Nickel-Chrome, Plated Brass | 3 |
| | Hydro Saver 1/2" NPT | 2.5 - 3.0 gpm | 1/2" | 1" Dia. (25.4mm) | 1-1/2" (38.1mm) | F—M | Polished Nickel Chrome Plated Brass | 4 |
| | #70-CN3 1/2" B Flo-Control | .25 - 4.0 gpm | 1/2" | 1" Hex (25.4mm) | 1-1/4" (31.8mm) | F—M, M—F | Brass | 1 |
| 39025 | #76-1A 1/2" PVC Flo-Control | .25 - 3.5 gpm | 1/2" | 1-1/2" Dia. (38.1mm) | 1-3/4" (44.5mm) | F—M, M—F | Type 1, Grade P.V.C. | 4 |
| * | #83-46A 1/2" P Flo-Control | .25 - 4.0 gpm | 1/2" | 1" Hex (25.4mm) | 1-7/8" (47.6mm) | F—F | Nickel-Chrome, Plated Brass | 3 |
| * | #83-46B 1/2" P Flo-Control | 5.0 - 10.0 gpm | 1/2" | 1" Hex (25.4mm) | 1-7/8" (47.6mm) | F—F | Nickel-Chrome, Plated Brass | 3 |
| 53503 | #70-CN25 3/4" B Flo-Control | .25 - 10.0 gpm | 3/4" | 1-3/32" Hex (27.8mm) | 1-3/4" (44.5mm) | M—M | Brass | 2 |
| 54039 | #78-111 3/4" P Flo-Control | .25 - 10.0 gpm | 3/4" | 1-1/4" Hex (31.8mm) | 2" (50.8mm) | F—F | Nickel-Chrome, Plated Brass | 3 |
| | #77-4 1" B Flo-Control | 5.0 - 20.0 gpm | 1" | 1-3/8" Hex (34.9mm) | 2-1/4" (57.2mm) | M—M | Brass | 2 |
| * | #78-109 1" P Flo-Control | 5.0 - 20.0 gpm | 1" | 1-1/2" Hex (38.1mm) | 2-3/4" (69.9mm) | F—F | Nickel-Chrome, Plated Brass | 3 |

*Specify flo rate

Duff commercial/Industrial Flo-ets provide flow control in a variety of applications, including multi-story buildings, water treatment equipment, cooling towers, and agricultural irrigation systems.

These highly efficient flow controls are available in flow rates from 1/4 gpm to 28 gpm. The body of the Commercial/Industrial Flo-et is a steel nipple with sizes from 3/4 inch to 6 inches in diameter.

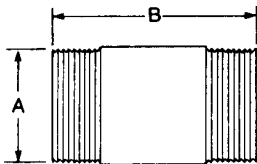

| ORDER NUMBER | A | | B | | APPROX. WEIGHT | | STATE FLOW WHEN ORDERING | | NO. OF FLO-ETS EACH |
|--------------|--------------------|--------------|-------------|--------------|----------------|----------|--------------------------|-----------------|---------------------|
| | N.P.T. U.S. INCHES | CENTI-METERS | U.S. INCHES | CENTI-METERS | U.S. LBS. | KILOGRAM | U.S. GALLONS PER/MIN. | LITERS PER/MIN. | |
| 53503 | 3/4" | 1.90 | 1-3/4" | 4.4 | 3 oz. | .08 Kg | 0.25-10 | .95-38 | 1 |
| | 1" | 2.54 | 2-1/4" | 5.7 | 6 oz. | .17 Kg | 5-20 | 17-76 | 1 |
| 65027 | 2" | 5.08 | 4" | 10.2 | 1.5 lbs. | .68 Kg | 15-30 | 57-114 | 3 |
| 55649 | 3" | 7.62 | 4-1/2" | 11.4 | 2.75 lbs. | 1.25 Kg | 30-70 | 114-265 | 7 |
| 55111 | 4" | 10.16 | 5" | 12.7 | 4.75 lbs. | 2.15 Kg | 60-120 | 227-454 | 12 |
| 66527 | 5" | 12.70 | 5" | 12.7 | 6 lbs. | 2.72 Kg | 70-190 | 265-719 | 19 |
| 73882 | 6" | 15.24 | 5-1/2" | 14.0 | 8.75 lbs. | 3.97 Kg | 140-280 | 530-1060 | 28 |

*On 3/4" N.P.T. and 1" N.P.T. body material is brass.

DUFF FLOW REGULATORS

Flo-et flow controls offer many advantages over conventional valve-type flow controls.

Initially, flo-et controls cost less to install. And, because they require no maintenance or adjustments, they maximize cost saving over the life of your equipment.

Flo-et flow controls are completely tamper-proof, yet authorized persons can easily alter them for increases or decreases in flow rate.

Duff offers a wide range of customized Flo-et inserts to meet your exact application needs. Both Flo-et inserts and retainers are ideal for incorporation into custom-designed housings. This provides additional cost savings by eliminating the need to purchase the brass housing. Because of our unique design, Duff can offer you the option to purchase only the Flo-et insert or the insert and the retainer.

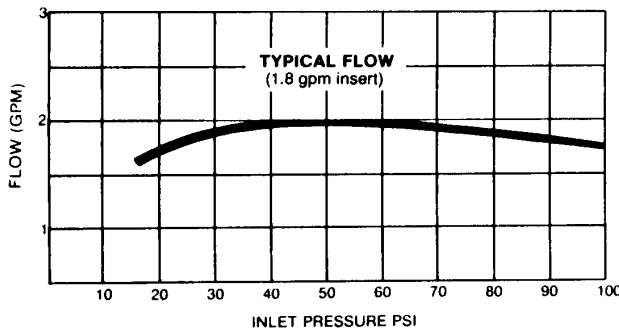

| | | | | | | | | | | | | | | | | | |
|-----------|---------------------|----------|----------------------|--------------------|--------------|--------------------|----------|------------------|----------|-----------|----------|------|--------|------|------------|------------|------------------------|
| | ABRASION RESISTANCE | SUNLIGHT | OXIDATION RESISTANCE | SOLVENT RESISTANCE | ALPHANUMERIC | SOLVENT RESISTANCE | ALUMINUM | ORGANIC SOLVENTS | ALCOHOLS | GIL & GIL | RESOLINE | ACID | DILUTE | ACID | RESISTANCE | CONTROLLED | WATER SWEEP RESISTANCE |
| Fair | | ● | | | | | | | | | | | | | | | |
| Good | ● | | ● | | | ● | | | | | | | | ● | | | |
| Excellent | | | | ● | | | | | | | ● | | | | | | ● |

Normal Operating Temperature Range 40° F to 140° F (5° C to 60° C)
Normal Operating Pressure Range 20 to 120 psi
(1.4 - 8.4 Kg per Sq. Cm.)

CHEMICAL RESISTANCE CHART (58B & 78B Series Inserts)

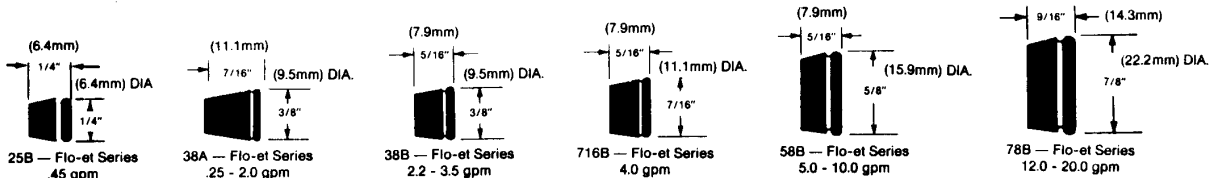

| Order No. | Description |
|-----------|-------------------|
| | #25B4-52 0.45 gpm |
| | #38A3-47 0.25 gpm |
| | #38A3-57 0.30 gpm |
| 52289 | #38A4-47 0.40 gpm |
| 49208 | #38A4-57 0.50 gpm |
| | #38A5-46 0.60 gpm |
| | #38A5-47 0.70 gpm |
| 72560 | #38A5-57 0.80 gpm |
| | #38A6-47 0.90 gpm |
| 49886 | #38A6-57 1.0 gpm |
| 50657 | #38A7-47 1.2 gpm |

| Order No. | Description |
|-----------|--------------------|
| | #38A7-52 1.4 gpm |
| | #38A8-47 1.6 gpm |
| | #38A8-52 1.8 gpm |
| 49887 | #38A8-57 2.0 gpm |
| | #38B9-52 2.2 gpm |
| 49888 | #38B9-57 2.5 gpm |
| | #38B10-52 2.6 gpm |
| 49889 | #38B10-57 3.0 gpm |
| | #38B10-623 3.5 gpm |

| Order No. | Description |
|-----------|---------------------|
| 49890 | #716B11-623 4.0 gpm |
| 49891 | #58B13-535 5.0 gpm |
| 49892 | #58B14-568 6.0 gpm |
| 49893 | #58B15-568 7.0 gpm |
| 49894 | #58B16-568 8.0 gpm |
| | #58B16-602 9.0 gpm |
| 49895 | #58B17-602 10 gpm |
| 49896 | #78B20-58 12 gpm |
| 49897 | #78B21-62 15 gpm |
| | #78B23-62 17 gpm |
| 49898 | #78B24-74 20 gpm |

Note: Special flow rates can be designed upon request.

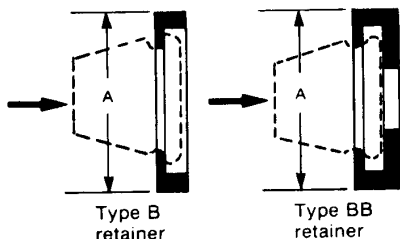

Type B retainer is intended for a press fit into an adapter that provides back-up support for the Flo-et insert. The BB type can be used in an adapter that does not provide back-up support.

| Order No. | Description | "A" Dimension | | For Insert Series No. |
|-----------|--------------------|---------------|-------------|-----------------------|
| | | Inches | Millimeters | |
| | #25R-1BB Retainer | .301 - .303 | 7.6 - 7.7 | 25B |
| | #38R-1B Retainer | .463 - .465 | 11.7 - 11.8 | 38A & 38B |
| 70974 | #38R-1BB Retainer | .463 - .465 | 11.7 - 11.8 | 38A & 38B |
| 49875 | #38R-2B Retainer | .525 - .527 | 13.3 - 13.4 | 38A & 38B |
| 49881 | #38R-4BB Retainer | .787 - .789 | 20.0 - 20.1 | 38A & 38B |
| 49878 | #716R-1B Retainer | .525 - .527 | 13.3 - 13.4 | 716B |
| 49882 | #716R-2BB Retainer | .787 - .789 | 20.0 - 20.1 | 716B |
| 49883 | #58R-2BB Retainer | .787 - .789 | 20.0 - 20.1 | 58B |
| 49885 | #58R-4BB Retainer | .995 - .997 | 25.2 - 25.3 | 58B |
| 50658 | #78R-2BB Retainer | .995 - .997 | 25.2 - 25.3 | 78B |

DUFF CO. REGULATORS-BACKFLOWPREVENTERS-METERS

DUFF FLOW REGULATORS

PVC FLOW REGULATORS

Duff PVC flow controls are designed for applications where constant flow rates are required and variable pressures are encountered. They are ideal for use in environments where metal housings are not recommended, such as high purity, deionized water applications. Flow capacities are available from 1/4 gpm to 540 gpm. Specify exact GPM flow rate.

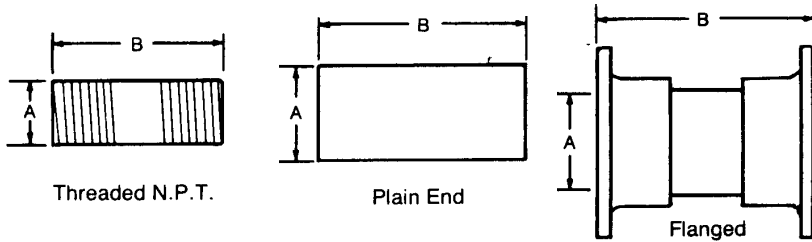

T H R E A D E D

| FLOW RATE GPM (1) | NO. OF INSERTS | PIPE SIZE "A" | MODEL NO. | LENGTH "B" (INCHES) | APPRX WEIGHT LBS. | FIG. NO. | PRICE |
|-------------------|----------------|---------------|-----------|---------------------|-------------------|----------|-------|
| .25-3.5 | 1 | 1/2 | T-050-1 | 2 | .05 | 53801 | |
| .25-10 | 1 | 3/4 | T-075-1 | 2 | .06 | 65707 | |
| 5-20 | 1 | 1 | T-100-1 | 3 | .12 | 47566 | |
| 10-20 | 2 | 1-1/4 | T-125-2 | 3 | .18 | 83723 | |
| 20-40 | 4 | 1-1/2 | T-150-4 | 3 | .25 | 61035 | |
| 35-70 | 7 | 2 | T-200-7 | 3 | .31 | 53585 | |
| 45-90 | 9 | 2-1/2 | T-250-9 | 4 | .56 | 83731 | |
| 70-140 | 14 | 3 | T-300-14 | 4 | .68 | 52813 | |
| 120-250 | 25 | 4 | T-400-25 | 4 | 1.00 | 52782 | |
| 270-540 | 54 | 6 | T-600-54 | 4 | 2.50 | 83732 | |

P L A I N E N D

| FLOW RATE GPM (1) | NO. OF INSERTS | PIPE SIZE "A" | MODEL NO. | LENGTH "B" (INCHES) | APPRX WEIGHT LBS. | FIG. NO. | PRICE |
|-------------------|----------------|---------------|-----------|---------------------|-------------------|----------|-------|
| .25-3.5 | 1 | 1/2 | P-050-1 | 5 | .09 | 63261 | |
| .25-10 | 1 | 3/4 | P-075-1 | 5 | .12 | 83720 | |
| 5-20 | 1 | 1 | P-100-1 | 5 | .18 | 83728 | |
| 10-20 | 2 | 1-1/4 | P-125-2 | 5 | .27 | 57017 | |
| 20-40 | 4 | 1-1/2 | P-150-4 | 5 | .36 | 57019 | |
| 35-70 | 7 | 2 | P-200-7 | 5 | .47 | 65862 | |
| 45-90 | 9 | 2-1/2 | P-250-9 | 5 | .80 | 83733 | |
| 70-140 | 14 | 3 | P-300-14 | 5 | 1.00 | 62133 | |
| 120-250 | 25 | 4 | P-400-25 | 5 | 1.47 | 83734 | |
| 270-540 | 54 | 6 | P-600-54 | 8 | 3.90 | 83735 | |

F L A N G E D

| FLOW RATE GPM (1) | NO. OF INSERTS | PIPE SIZE "A" | MODEL NO. | LENGTH "B" (INCHES) | APPRX WEIGHT LBS. | FIG. NO. | PRICE |
|-------------------|----------------|---------------|-----------|---------------------|-------------------|----------|-------|
| 35-70 | 7 | 2 | F-200-7 | 6 | 2.43 | 56081 | |
| 45-90 | 9 | 2-1/2 | F-250-9 | 6 | 3.80 | 83736 | |
| 70-140 | 14 | 3 | F-300-14 | 6 | 4.76 | 83737 | |
| 120-250 | 25 | 4 | F-400-25 | 6 | 7.55 | 52971 | |
| 270-540 | 54 | 6 | F-600-54 | 6 1/2 | 12.60 | 83738 | |

FRS-Series Flow Regulators

For Food Service

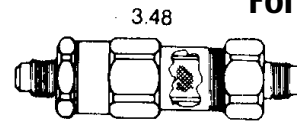

0.06 to 1.0 GPM

- 1/8" Flare - Inlet & Outlet
- Serviceable 100 x 90 Mesh Monel Screen
- Brass Housing
- 5.5 oz. Net Weight

SS-G Series Stainless Steel Flow Regulators

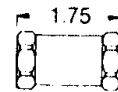

- 3/8" FNPT - Inlet/Outlet
- 0.06 to 1.0 GPM
- 3 oz. Net Weight

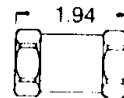

- 1/2" FNPT - Inlet/Outlet
- 1.0 to 6.0 GPM
- 3 1/2" oz. Net Weight

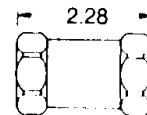

- 3/4" FNPT - Inlet/Outlet
- 1.0 to 11.5 GPM
- 8 oz. Net Weight

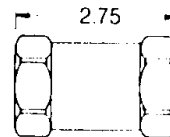

- 1" FNPT - Inlet/Outlet
- 1.0 to 30 GPM
- 12 oz. Net Weight



DUFF SELLS

SOLUTIONS!

CALL US TODAY!

610-275-4453

WATER METERS

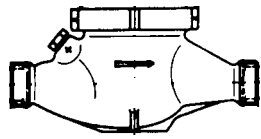

MULTI-JOB COLD WATER METERS measure unheated water below 100°F. They can be used to

detect waste or leaks, to allocate cost accounting charges and to set standards of water consumption. Center sweep register, superior accuracy, magnetic drive.

WITH COUPLINGS

| SIZE | FIG. NO. | PRICE |
|---------|----------|-------|
| 5/8X1/2 | 47606 | |
| 5/8X3/4 | 47607 | |
| 1 | 47608 | |
| 1 1/2 | 47609 | |
| 2 | 47610 | |

METER COUPLINGS, NUTS AND WASHERS

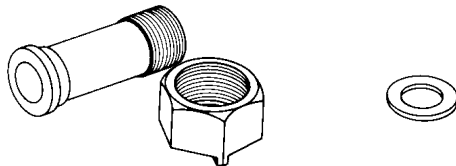

| COUPLING & NUT | | | WASHER | | |
|----------------|----------|-------|--------|----------|-------|
| SIZE | FIG. NO. | PRICE | SIZE | FIG. NO. | PRICE |
| 1/2 | 7157 | | 1/2 | 36273 | |
| 3/4 | 7158 | | 3/4 | 43678 | |
| 1 | 7159 | | 1 | 43679 | |
| 1 1/2 | 7160 | | 1 1/2 | 43680 | |
| 2 | 7161 | | 2 | 43681 | |

CONTACT HEAD METER (LESS TOTALIZER)



| SIZE | FIG. NO. | PRICE |
|------|----------|-------|
| 3/4" | 43369 | |
| 1" | 44949 | |
| 1/2" | 44950 | |
| 2" | 44951 | |
| 3" | 44952 | |

REMOTE TOTALIZER (BATTERY OPERATED)



ALSO AVAILABLE WITH RESET BUTTON

| FIG. NO. | PRICE |
|----------|-------|
| 7168 | |



You must order meter AND totalizer for remote applications!

FLANGED WATER METER



Center sweep register, superior accuracy, magnetic drive.

| SIZE | FIG. NO. | PRICE |
|------|----------|-------|
| 2" | 45186 | |
| 3" | 44426 | |
| 4" | 44427 | |

Brass Flange & Gasket Sets (pair) 1/2" - 2" use Meter Flanges

| SIZE | FIG. NO. | PRICE |
|--------|----------|-------|
| 1 1/2" | 53771 | |
| 2" | 50702 | |

***For 3"&4" Meter, use Brass or Black Iron Companion Flanges - See pages 70 or 59**

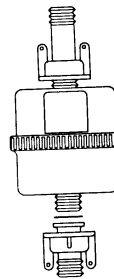

POLYMER Suitable for D.I. use. Polymer & thermoplastic for potable cold water. 120° F WP to 150 psi. Tamper proof, non-corrosive, low cost.

| DESCR | FIG. NO. | PRICE |
|--|----------|-------|
| 1/2" 125-20 Horizontal or vertical installation | GPM | 23541 |
| 3/4" 25-20 max flo 20 | | 30094 |



HOT AND WARM WATER METERS are designed for measurement at temperatures from 100 to 450°F. Ideal for boiler feed, factory hot water installations, condensate return and similar application.

| SIZE | FIG. NO. | PRICE |
|------|----------|-------|
| 3/4" | 7162 | |

DUFF CO. REGULATORS-BACKFLOWPREVENTERS-METERS

FLO-METERS

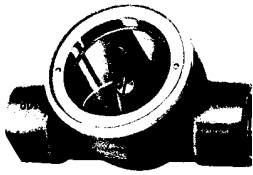

Midwest **sight flow indicators.** Inexpensive protection for expensive equipment. Manufactured of quality materials and safety-tested to assure you of long, dependable service at an economical price.

Sight flow indicators are standard construction. Indicators of other metals, pressures and temperatures are available. All standard production sight flow indicators have the following specifications:

Bonze body, 304 stainless spinner shaft, lightweight plastic spinner for indicating low flow, operating pressure 125 psi, operating temperature 200oF, glass windows, hydrostatically tested to double recommended rating, window available in tempered glass!

| SIZE | GLASS THICKNESS | LENGTH | HEIGHT | WIDTH | FIG. NO. | PRICE |
|-------|-----------------|----------|--------|--------|----------|-------|
| 1/2 | 1/4" | 3 13/16" | 2 1/8" | 1 3/4" | 16376 | |
| 3/4 | 1/4" | 3 13/16" | 2 1/8" | 1 3/4" | 16378 | |
| 1 | 1/4" | 4 1/16" | 2 5/8" | 2 7/8" | 16380 | |
| 1 1/4 | 1/4" | 4 1/16" | 2 5/8" | 2 7/8" | 16382 | |
| 1 1/2 | 3/8" | 5 11/32" | 3 3/4" | 3 1/4" | 16385 | |
| 2 | 3/8" | 5 11/32" | 3 3/4" | 3 1/4" | 16388 | |

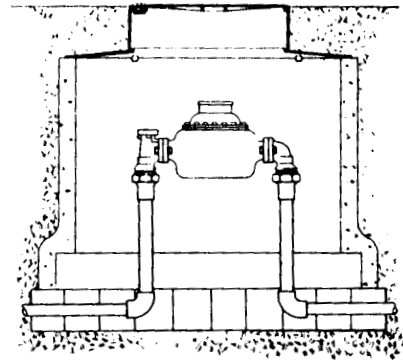

METER BOX & LID

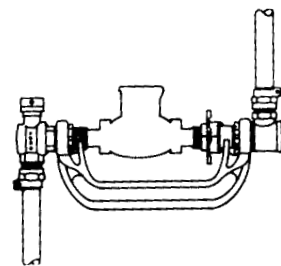

METER SETTER

E-Z VIEW RATE-OF-FLOW METERS

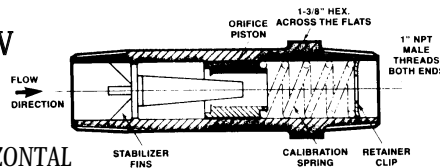

VERTICAL OR HORIZONTAL

| Media (Piston Type) | Flow Range | MODEL NUMBER | | | | |
|---|------------|------------------------------------|---|-------------------------------|-------------------|---------------------|
| | | 3/4" or 1" Nominal Brass Sweat Ftg | 1" Nominal PVC ² Sweat Fitting | 1" ³ Male NPT Poly | 3/4" Male NPT Ftg | 1/2" Female NPT Ftg |
| Oil (Standard Piston) .876 Sp. Gr. | 0.5-4 GPM | - | 628-104 | 621-104 | 625-104 | 624-104 |
| | 1.0-7 GPM | - | 628-107 | 621-107 | 625-107 | 624-107 |
| | 1.0-10 GPM | - | 628-110 | 621-110 | 625-110 | 624-110 |
| | 1.0-16 GPM | - | 628-116 | 621-116 | 625-116 | 624-116 |
| | 3.0-18 GPM | - | 628-118 | 621-118 | 625-118 | - |
| | 4.0-28 GPM | - | 628-128 | 621-128 | 625-128 | - |
| Water (Standard Piston) 1.0 Sp. Gr. | .05-4 GPM | 620-004 | 628-004 | 621-004 | 625-004 | 624-004 |
| | 1.0-7 GPM | 620-007 | 628-007 | 621-007 | 625-007 | 624-007 |
| | 1.0-10 GPM | 620-010 | 628-010 | 621-010 | 625-010 | 624-010 |
| | 1.0-16 GPM | 620-016 | 628-106 | 621-016 | 625-106 | 624-016 |
| | 4.0-18 GPM | 620-018 | 628-108 | 621-018 | 625-018 | - |
| | 4.0-28 GPM | 620-028 | 628-028 | 621-028 | 625-028 | - |
| Water (Ribbed Piston) 1.0 Sp. Gr. | 1.5-7 GPM | 620-307 | 628-307 | 621-307 | 625-307 | 624-307 |
| | 3.0-10 GPM | 620-310 | 621-310 | 621-310 | 625-310 | 624-310 |
| | 3.0-17 GPM | 620-316 | 628-316 | 621-316 | 625-316 | 624-316 |
| | 4.0-24 GPM | 620-324 | 628-324 | 621-324 | 625-324 | - |
| Hex | - | 1.5" | 1.5" | 1.125 | 1.5" | 1.5" |
| Length In (MM) | - | 7.8" | 8.5" | 5.3" | 8.3" | 7.8" |
| | | 198 MM | 216 MM | 135 MM | 211MM | 198 MM |
| Weight | - | 13 oz. | 5 oz. | 3 oz. | 1 lb. | 1 lb. |

1 Fits 3/4" Nominal (7/8" OD) or 1" nominal 1-1/8" OD) Type M Copper Tubing
 2 (1.315 OD and 0.935 ID) for use with Schedule 40, 80 & 120 PVC Pipe Fittings
 3 DO NOT use pipe dope. Use teflon tape only.

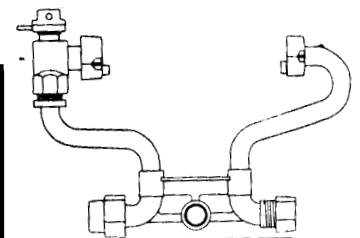

METER YOKE

CALL DUFF COMPANY WITH THE NAME OF YOUR WATER COMPANY - WE WILL QUOTE YOU ON EXACT SPECIFICATIONS THAT ARE REQUIRED!

FLO-METERS

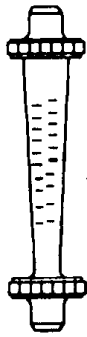

| FIG. NO. | FLOW RATE | PIPE SIZE | PRICE |
|----------|--------------|-----------|-------|
| 61513 | .025 to .250 | 3/8" MPT | |
| 61514 | .025 to .250 | 1/2" MPT | |
| 47779 | .1 to 1 | 3/8" MPT | |
| 61516 | .1 to 1 | 1/2" MPT | |
| 61519 | .2 to 2 | 3/8" MPT | |
| 61520 | .2 to 2 | 1/2" MPT | |
| 61521 | .5 to 5 | 3/8" MPT | |
| 47780 | .5 to 5 | 1/2" MPT | |
| 47781 | 1 to 10 | 3/4" MPT | |
| 61522 | 3 to 30 gph | 3/8" MPT | |
| 61523 | 3 to 30 gph | 1/2" MPT | |
| 61524 | 5 to 60 gph | 3/8" MPT | |
| 61525 | 5 to 60 gph | 1/2" MPT | |

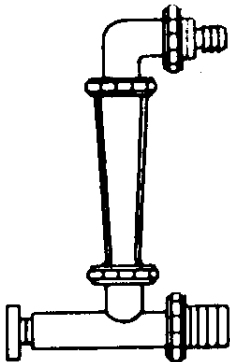

| FIG. NO. | FLOW RATE | PIPE SIZE | PRICE |
|----------|--------------|--------------|-------|
| 61526 | .025 to .250 | 3/8" MPT | |
| 61527 | .025 to .250 | 1/2" MPT | |
| 61528 | .025 to .250 | 1/2" ID Barb | |
| 61529 | .1 to 1 | 3/8" MPT | |
| 61530 | .1 to 1 | 1/2" MPT | |
| 61531 | .1 to 1 | 1/2" ID Barb | |
| 61532 | .2 to 2 | 3/8" MPT | |
| 61533 | .2 to 2 | 1/2" MPT | |
| 61534 | .2 to 2 | 1/2" ID Barb | |
| 61535 | .5 to 5 | 3/8" MPT | |
| 61536 | .5 to 5 | 1/2" MPT | |
| 61537 | .5 to 5 | 1/2" ID Barb | |
| 61538 | 1 to 10 | 1/2" MPT | |
| 61540 | 1 to 10 | 3/4" MPT | |
| 61541 | 1 to 10 | 1/2" ID Barb | |
| 61542 | 1 to 10 | 5/8" ID Barb | |

61546-61553

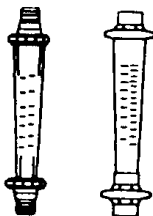

61554-61556

61557 to 61562

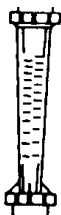

| FIG. NO. | FLOW RATE | PIPE SIZE | PRICE |
|----------|----------------|-----------|-------|
| 61546 | .1 to 1 | 3/8" FPT | |
| 61547 | .1 to 1 | 1/2" MPT | |
| 61548 | .2 to 2 | 3/8" FPT | |
| 61549 | .2 to 2 | 1/2" MPT | |
| 61550 | .5 to 5 | 3/8" FPT | |
| 61551 | .5 to 5 | 1/2" MPT | |
| 61552 | .5 to 5 | 3/4" MPT | |
| 61553 | 1 to 10 | 3/4" MPT | |
| 61554 | 1 to 10 | 1" FPT | |
| 71217 | 2 to 20 | 1" FPT | |
| 83074 | 3 to 30 | 1" FPT | |
| 61556 | 4 to 40 | 1" FPT | |
| 61557 | 2 to 20 | 2" FPT | |
| 61558 | 6 to 60 | 2" FPT | |
| 61559 | 10 to 80 | 2" FPT | |
| 61560 | 5 to 100 | 2" FPT | |
| 61561 | 15 to 130 | 2" FPT | |
| 61562 | 20 to 230 SCFM | 2" FPT | |

For additional information call: 610-275-4453 or Fax: 610-279-6299
 Prices are a guide only. Please call for current prices.

DUFF CO. REGULATORS-BACKFLOWPREVENTERS-METERS

SHOCK SUPPRESSORS

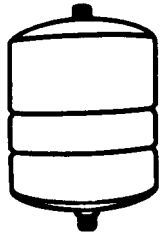

DIATROL SHOCK SUPPRESSOR

Max working pressure=100 PSIG.
 Max shock pressure=150 PSIG.
 Max operating temperature=200°F.
 Precharge pressure=22 PSIG.
 Large size to 48" diameter available!
 Compressible air volume is held within a light weight, deep drawn steel vessel. This air

chamber, carefully calculated, is separated from system water by a heavy-duty, sealed-in, butyl diaphragm that prevents loss of air and water logging. The air pressure can be measured and field adjusted through the vessel air valve. Water never contacts steel, and the polypropylene lined water reservoir provides a 100% corrosive-free surge chamber.

| FIG. NO. | RATED FLOW | CONN NPT | HEIGHT | DIA | VOLUME CU. FT. | PRICE |
|----------|------------|----------|--------|-------|----------------|-------|
| 48971 | 9.5 | 3/4 | 8 1/2 | 9 1/8 | .092 | |
| 57113 | 104.6 | 1 1/4 | 11 7/8 | 6 1/8 | .145 | |

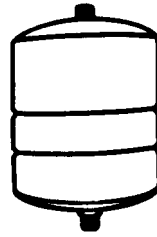

THERM-X-TROL Thermal Expansion Tank

Steel shell Polypropylene liner

Butyl diaphragm

Max operating pressure=200°F Standard factory precharge 40 PSIG

For use with potable water heaters only. Therm-X-Trols are pressurized, diaphragm-type expansion tanks designed to accept the expansion of water created when a storage tank is heated, keeping the system pressure below the relief valve setting.

| FIG. NO. | MAX PSIG | TANK VOL | SYS CONN | DIA | PRICE |
|----------|----------|----------|----------|--------|-------|
| 43561 | 150 | 2.0 | 3/4" | 8 | |
| 38696 | 150 | 4.4 | 3/4" | 11 | |
| 49699 | 150 | 10.3 | 1 | 15 3/8 | |

OTHER TANK VOLUMES AVAILABLE

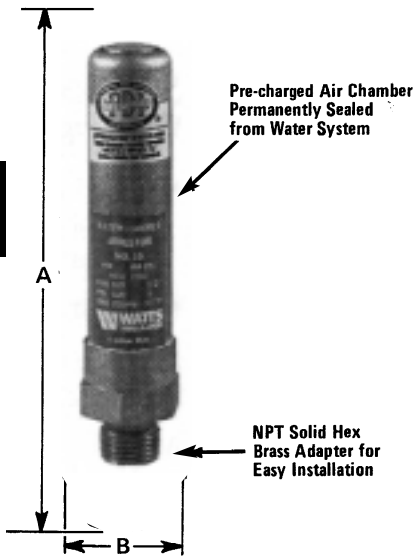

WATER HAMMER

The noise from banging pipes is caused by shocks of high speed water flowing in the piping system when a fixture is suddenly closed. Sudden stoppage of the water (a non-compressible liquid) flowing at a given pressure and velocity causes a surge or spike of water and is called water hammer. When this occurs a pressure wave travels back through the piping until it finds a point of relief. Dishwashers, clothes washers, fast closing positive shut off valves incorporated in the system, all contribute to creating water shock which is not only annoying but damaging to pipes and appliances. The Watts No. 15 Series incorporates a permanent pre-charged sealed air chamber to absorb the shock. The sealed chamber prevents the loss of air to the water and insures long and trouble free life. All potential leak points are permanently sealed.

| NPT CONN | AIR PRE-LOAD PSI | DIMENSIONS | | FIXTURE UNITS | FIG. NO. | PRICE |
|----------|------------------|------------|---------|---------------|----------|-------|
| | | A | B | | | |
| 1/2" | 60 | 5 1/2" | 1 7/16" | 1-11 | 55131 | |
| 3/4" | 60 | 7 1/2" | 1 7/8" | 12-32 | 51666 | |
| 1" | 60 | 8 1/8" | 2 3/16" | 33-60 | 55135 | |

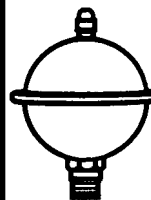

MINI-TROL shock suppressor.

Max working pressure=150 PSIG. Max shock pressure=200 PSIG. Max operating temp=200°F. Max velocity=10 FPS Total Volume=10 cu. inc. Precharge pressure=22 PSIG.

| FIG. NO. | HGHT | WIDTH | SYS CONN | PRICE |
|----------|-------|-------|----------|-------|
| 8799 | 4 1/2 | 3 3/8 | 1/2NPT | |



MINI CHAMBER Designed for single fixture use

Copper cylinder
 Spun-closed seamless chamber (1.4" cu. vol.)
 Max operating temperature=250°F.
 Arrestor length 4 1/4" not including fitting
 Permanently sealed 60 PSI pressure charge.

An acetal piston with three EPDM O-rings separates a 60 psi pre-pressurized, captured air cushion from system water in a seamless type L copper chamber. The mini chamber arrestor is available with various system connections in individually packaged film-wrapped cards or bulk packed in cartons.

| SIZE | FIG. NO. | PRICE |
|------|----------|-------|
| 3/8" | 85245 | |
| 1/2" | 85246 | |



PUMPS

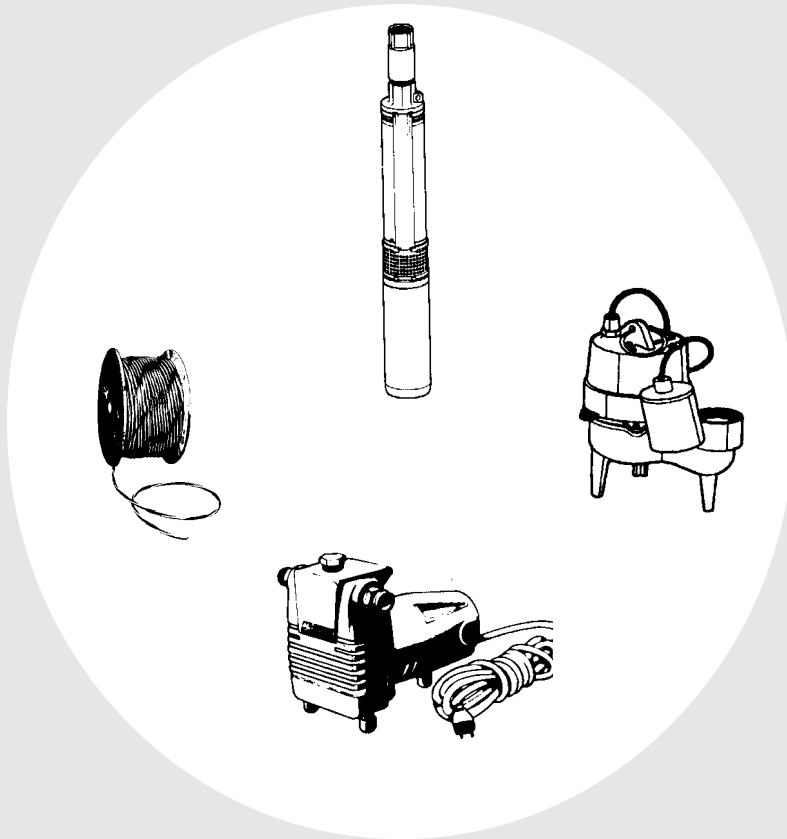

PUMPS

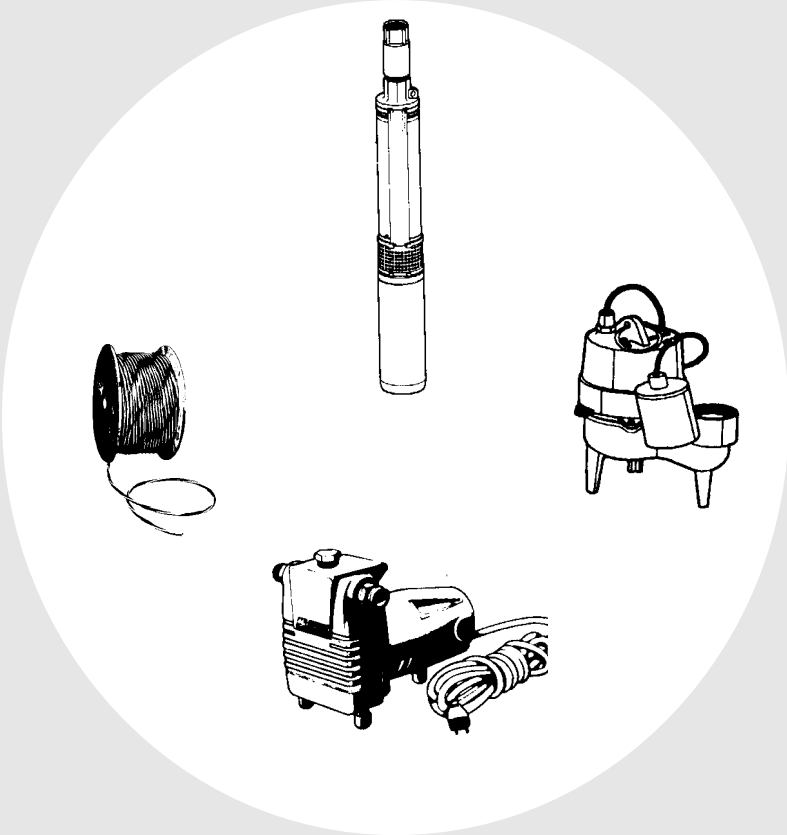

DUFF SUMP PUMPS AND CONTROLS

Duff submersible and pedestal sump pumps are designed to pump any basement drainage water and residential flooding.

TOOLS AND MATERIALS NEEDED FOR SUBMERSIBLE OR PEDESTAL SUMP PUMP INSTALLATION

- * Duff hose kit or PVC pipe and cement (or galvanized pipe)
- * PVC adapter (same size as PVC/ABS pipe)
- * Check valve
- * Plastic, fiberglass or concrete sump basin
- * Screwdriver, pipe wrench, adjustable wrench (med.-large)
- * Hacksaw with 24-tooth blade for cutting plastic pipe
- * Knife or round file for smoothing inside of plastic pipe connections.



GRUNDFOS

BASIC SUBMERSIBLE SUMP PUMP INSTALLATION

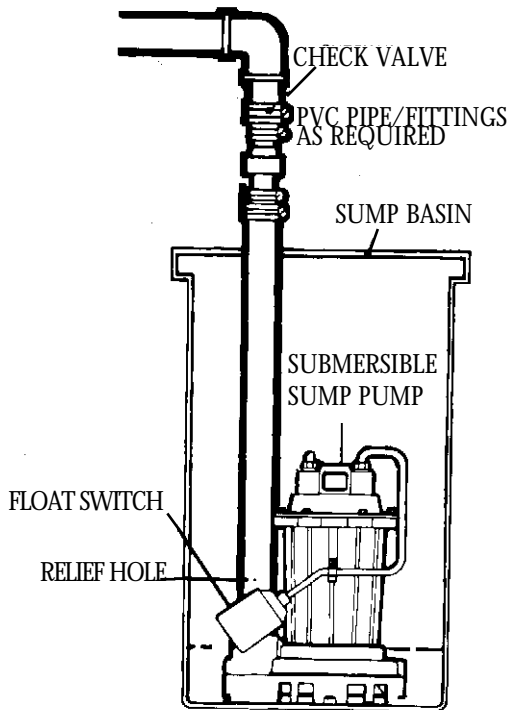

BASIC PEDESTAL SUMP PUMP INSTALLATION

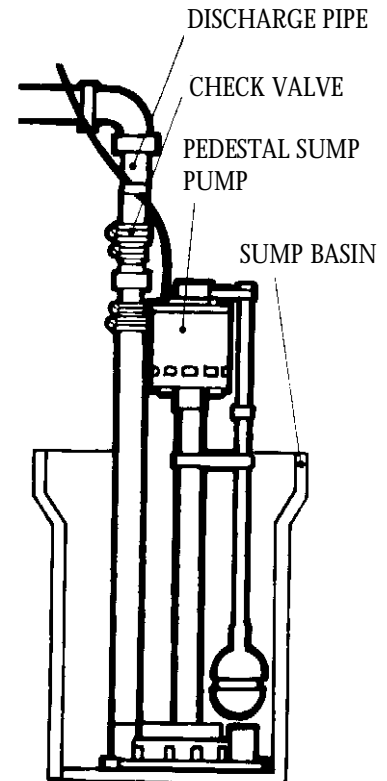

SUMP PUMP CONTROLS



DIAPHRAGM LEVEL CONTROL

Rated for 115V operation.
Available on all SS Style pumps

| FIG. NO. | PRICE |
|----------|-------|
| 8238 | |

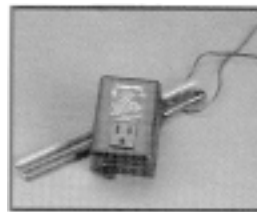

SSA NARROW SUMP SWITCH

No float to tangle and no moving parts - just stainless steel sensors. Converts system from wide angle float to stationary liquid level detection switch. For use in small sumps where it is not practical for two floats because sump opening is too small or corroded. Fully adjustable sensor rods for desire on/off levels.

| FIG. NO. | PRICE |
|----------|-------|
| 52287 | |



LIQUID LEVEL CONTROL

Patented solid state design
Use with sump or utility pumps
Keep sumps, basements, or tanks dry
Use to actuate water level alarms
Mounts anywhere - on pump, wall, etc.

| FIG. NO. | PRICE |
|----------|-------|
| 10644 | |

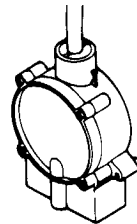

LITTLE GIANT LOW LEVEL DIPHHRAGM SWITCH

Converts any manual pump up through 1/2 HP to automatic operation on level 6".

| FIG. NO. | PRICE |
|----------|-------|
| 25363 | |

SUMP PUMP TRIM

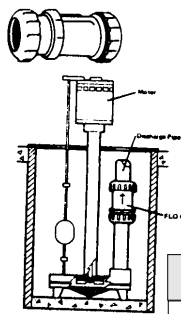

PVC SUMP PUMP SWING CHECK

Compression. One size fits 1 1/2x1 1/2, 1 1/2x1 1/4, or 1 1/4x1 1/4

| FIG. NO. | PRICE |
|----------|-------|
| 15900 | |

CORRUGATED SUMP PUMP HOSE KIT

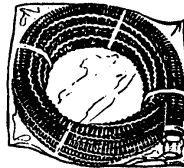

| FIG. NO. | PRICE |
|----------|-------|
| 15851 | |

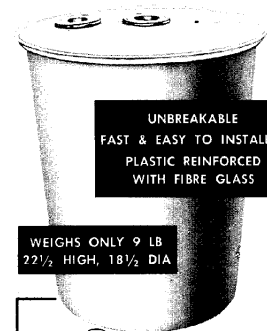

UNBREAKABLE
FAST & EASY TO INSTALL
PLASTIC REINFORCED
WITH FIBRE GLASS

WEIGHS ONLY 9 LB
22 1/2" HIGH, 18 1/2" DIA

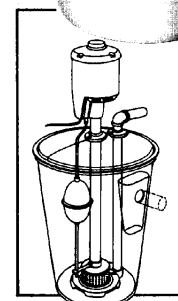

COMES READY TO INSTALL AS SHOWN AT LEFT
ONE MAN DOES IT IN ABOUT 30 MIN.
LID KEEPS OUT VERMIN AND DIRT. INVERT AND DRILL IT FOR SURFACE DRAIN.

SUMP PIT
18x22 Pit and Lid for submersible or upright sump pump.

| FIG. NO. | PRICE |
|----------|-------|
| 10885 | |



SUMP PUMP CHECK VALVE

Super quiet
Fiberglass body
Stainless steel flapper
Fits PVC, steel or copper

| SIZE | FIG. NO. | PRICE |
|--------------|----------|-------|
| 1 1/4 HxMale | 15838 | |
| 1 1/4 HxH | 15845 | |
| 1 1/2 HxH | 15846 | |
| 2 HxH | 15847 | |
| 3 HxH | 15849 | |

**DUFF GLADLY
ACCEPTS VISA AND
MASTERCARD!**

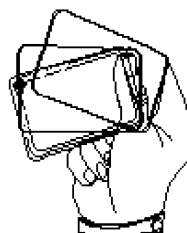



SUMP PUMPS
SUBMERSIBLE HIGH TEMPERATURE
PUMP

Cast Iron. Solids handling capability to 3/4", 1/3 HP, 115v. 1 1/2" NPT vertical discharge. Includes separate high temperature mercury float switch. **APPLICATIONS:** boiler blow down pits, condensate pits, hot water sumps. Liquid temperature - 200°F (93°C)

PERFORMANCE CURVE

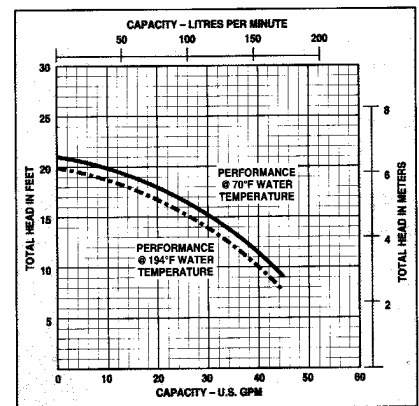

ORDERING INFORMATION

| Catalog Number | HP | Max. Load Amps | Volts | Phase/Cycle | Solids Handling Capability | Discharge |
|----------------|-----|----------------|-------|-------------|----------------------------|------------|
| 33040 | 1/3 | 12.0 | 115 | 1/60 | 3/4" | 1-1/2" NPT |



HEAVY DUTY BRASS SUMP PUMP
Durable bronze body-industrial as well as domestic applications. Dependable wide-angle or diaphragm level control. American made 1/2 HP motor, with over-load protection. 1 1/2" female discharge - 1800 GPH at 28' head.

| FIG. NO. | PRICE |
|----------|-------|
| 8209 | |

SUBMERSIBLE SUMP PUMP
Durable cast iron body. Reliable 1/3 HP American made motor. Dependable wide-angle or diaphragm level control. Adapts to manual or automatic operation.

| FIG. NO. | PRICE |
|----------|-------|
| 47005 | |

FLOAT TYPE SUMP PUMP
Mechanical snap action switch, cast iron epoxy coated, 10' power cord, 1/3 HP, 1 1/2" discharge. Model 6E-CIA-SFS.

| FIG. NO. | PRICE |
|----------|-------|
| 9283 | |

CAST BRONZE SUMP PUMP
1/2 HP, 1 1/2" discharge, heavy duty, diaphragm switch, 10' powercord.

| Gallons Per Hour | | | | | | |
|------------------|------|------|----------|-----|----------|-------|
| 1' | 10' | 20' | shut off | PSI | Fig. No. | Price |
| 3250 | 2500 | 1550 | 22.9 | 9.9 | 11541 | |

CAST IRON SUBMERSIBLE PUMP
Cast iron, epoxy coated, passes 1/2" solids, 1 1/2" discharge, diaphragm switch, 8' power cord, 1/3 HP motor.

| Gallons Per Hour | | | | | | |
|---|------|-----|----------|-----|----------|-------|
| 1' | 10' | 20' | shut off | PSI | Fig. No. | Price |
| 2750 | 1750 | 750 | 18.0 | 7.8 | 11539 | |
| SAME AS 11539 WITH 25' CORD LESS SWITCH | | | | | | |
| 2750 | 1750 | 750 | 18.0 | 7.8 | 48537 | |

BACK-UP SUMP PUMP SYSTEM

The greatest protection for basements. Uses any standard 12 volt battery. Battery is kept charged and automatically recharges when pump is used. If power goes out or the main sump pump fails, the battery pump will keep the basement dry and free of potential damage. Pump is made of corrosion resistant thermoplastics. High head pump to accommodate long piping runs. Sold LESS BATTERY.

| Discharge Height above pumping level | Performance - up to 5100 gallons per hour | | | | | | |
|--------------------------------------|---|----|-----|-----|-----|-----|-----|
| | 0' | 5' | 10' | 15' | 20' | 25' | 30' |
| Gallons per minute | 23 | 20 | 18 | 14 | 10 | 6 | 1 |

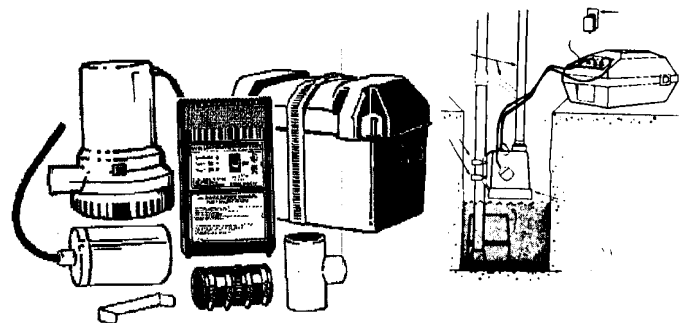

| FIG. NO. | PRICE |
|----------|-------|
| 58653 | |

For additional information call: 610-275-4453 or Fax: 610-279-6299
Please call for current prices.

SUMP PUMPS

GEYSER II "CLASSIC"

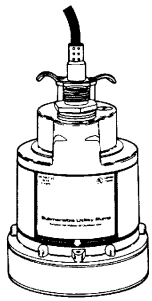

Open type trash impeller resists clogging
Removable screen for easy cleaning
1 1/4" FPG discharge with garden hose adapter included
Pumps floor dry to 1/8"
Fits into 7" opening
Two year warranty

| FIG. NO. | PRICE |
|----------|-------|
| 10629 | |

| Discharge Height above pumping level | Performance - up to 5100 gallons per hour | | | | |
|--------------------------------------|---|----|-----|-----|-----|
| | 0' | 5' | 10' | 15' | 20' |
| Gallons per minute | 21 | 19 | 17 | 14 | 8 |

MARK IV

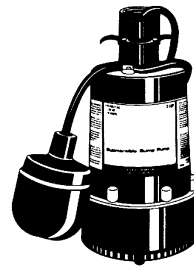

Heavy duty 1/2 HP, 115 volt oil filled motor, 6.3 Amps
High capacity - rate 85 GPM
Automatic operation features piggy-back style float switch
Removable snap-off strainer for easy cleaning
Vent relief prevents air lock
1 1/2" MPT discharge
Fits into 2" diameter sump

| FIG. NO. | PRICE |
|----------|-------|
| 50555 | |

| Discharge Height above pumping level | Performance - up to 5100 gallons per hour | | | | |
|--------------------------------------|---|----|-----|-----|-----|
| | 0' | 5' | 10' | 15' | 20' |
| Gallons per minute | 85 | 65 | 45 | 28 | 4 |

GEYSER "CLASSIC" SUMPLESS

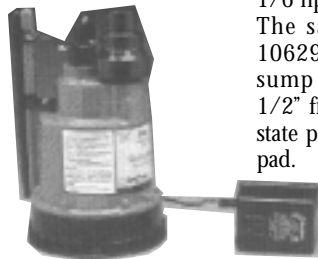

1/6 hp, 115 volt oil filled motor, 5 amps
The same "Classic" utility pump as 10629, but converted to an automatic sump pump that can pump down to 1/2" from floor. Includes pump, solid state probe switch, check valve and mud pad.

| FIG. NO. | PRICE |
|----------|-------|
| 10631 | |

| Discharge Height above pumping level | Performance - up to 1260 gallons per hour | | | | |
|--------------------------------------|---|----|-----|-----|-----|
| | 0' | 5' | 10' | 15' | 20' |
| Gallons per minute | 21 | 19 | 17 | 14 | 8 |

Don't see what you're looking for?
Call the pump experts at Duff
Company for ALL your pump needs!

610-275-4453

SUPER GEYSER

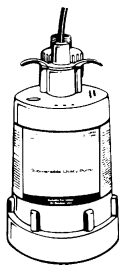

3 HP, 115 volt motor, 10 Amps
Pumps floor dry to 5/8"; fits into 7" opening
1 1/4" MPT discharge with garden hose adapter included.

| FIG. NO. | PRICE |
|----------|-------|
| 37878 | |

| Discharge Height above pumping level | Performance - up to 1860 gallons per hour | | | | | |
|--------------------------------------|---|----|-----|-----|-----|-----|
| | 0' | 5' | 10' | 15' | 20' | 25' |
| Gallons per minute | 36 | 29 | 27 | 21 | 12 | 1 |

GRUNDFOS STAINLESS STEEL SUMP & UTILITY PUMP



Stainless steel. Handles clean or gray water. Pump up to 4080 gallons per hour, Series KP pumps can handle solids up to 3/8". Suited for hard to reach areas. Operates continuously in hot water up to 95o F. Automatic thermal protection and restart system to prevent motor damage. All stainless steel housing, impeller, and suction screen. Use for effluent, clear or dirty sump water, grey water and waste water, draining ponds, pits and tanks, de-watering, draining and filling tanks, draining pools & spas, light commercial mixing. DO NOT USE FOR: raw sewage, flammables, highly corrosive liquids. Flow range = .5-.68 US GPM. Temp range 32o-95oF (0o-35oC) Continuous, 32o-122oF (0o-50oC) Intermittent (totally submerged). Minimum pumping level - 1/2 inch

| HP | Descr | Model | Fig. No. | Price |
|-----|-------|--------|----------|-------|
| 1/5 | Auto | KP150A | 67065 | |
| 1/3 | Auto | KP250A | 67158 | |
| 1/2 | Auto | AP12A | 67160 | |

SUBMERSIBLE SUMP PUMP

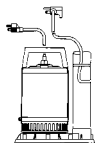

Durable cast iron body.
Reliable 1/3 HP American made motor. Dependable wide-angle or diaphragm level control. Adapts to manual or automatic operation.

| DESCRIPTION | FIG. NO. | PRICE |
|-------------------------------|----------|-------|
| Sump pump w/ diaphragm switch | 25253 | |

PEDESTAL SUMP PUMP

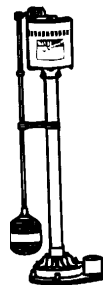

| DESCR | FIG. NO. | PRICE |
|---------|----------|-------|
| Bronze | 47431 | |
| Plastic | 67490 | |

ALL PURPOSE PUMPS

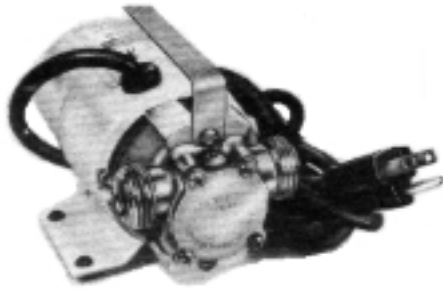

ORIGINAL PONY PUMP

115 volt, AC. Instant self-priming. Moves up to 360 GPM with hydro impeller. Excellent for even tanks and water heater. 3/4" GH in & out.

| VOLT | FIG. NO. | PRICE |
|---------------------|----------|-------|
| 115 AC | 10700 | |
| 12 V | 10697 | |
| IMPELLER REPAIR KIT | | |
| FIG. NO. | PRICE | |
| 28174 | | |

H A N D I - P U M P

Cordless Utility Pump. Many household uses. Powerful - Pumps up to 4.5 gallons per minute. Safe - non-electric, uses one 6 volt lantern battery (not included). Completely Submersible!

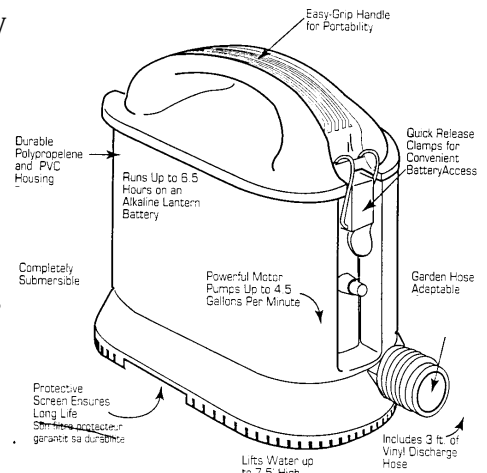

| FIG. NO. | PRICE |
|----------|-------|
| 65799 | |

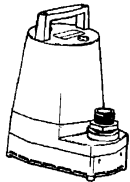

WATER WIZZARD

Bottom pick up. 1" Female discharge. Epoxy coated aluminum, removes water to 1/8", 1" IP with garden hose adapter. Pumps to 26" high.

WITH LOW LEVEL SWITCH

| FIG. NO. | PRICE | FIG. NO. | PRICE |
|----------|-------|----------|-------|
| 46933 | | 57068 | |

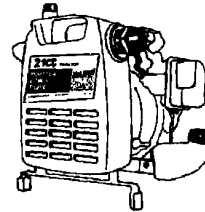

FUEL TRANSFER PUMP

Gas driven (40 minutes to one tank), Self-priming, 3/4" IPS, wt=30 lbs. 21 CC McCullough engine.

| FIG. NO. | PRICE |
|----------|-------|
| 44607 | |



PORTABLE GAS UTILITY PUMP

2 cycle McCullough engine, includes 3/4"x10' hose, primes in 15 seconds.

| FIG. NO. | PRICE |
|----------|-------|
| 44606 | |

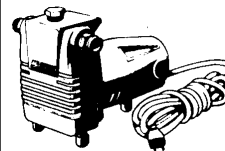

UTILITY PUMP

Compact, portable design, self priming. High powered 1/2 HP, 7500-RPM, 115 volt, double insulated american made motor. 3/4" inlet and outlet.

| FIG. NO. | PRICE |
|----------|-------|
| 9286 | |

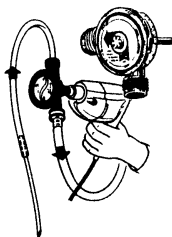

DRILL PUMP

| FIG. NO. | PRICE |
|----------|-------|
| 10668 | |

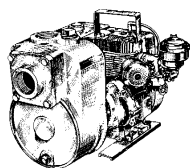

8M CONTRACTOR PUMP

Heavy duty, cast iron case will survive even the most rugged applications. Self-priming. Non-clogging, semi-open, cast iron impeller. Gas-driven engine is air-cooled and has manual start.



3.5 HP, 2" inlet & outlet.

| FIG. NO. | PRICE |
|----------|-------|
| 45485 | |

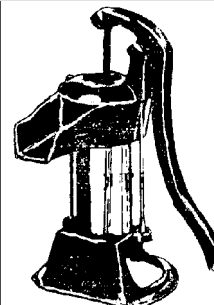

PITCHER PUMP

- *Brass body
- *Left or right hand
- *Cut-a-way base
- *3" Dia. cylinder
- *1 1/4" pipe tape
- *Spout type

| FIG. NO. | PRICE |
|----------|-------|
| 10605 | |

For additional information call: 610-275-4453 or Fax: 610-279-6299
Please call for current prices.

LAUNDRY TRAY PUMPS

LAUNDRY TRAY PUMP



Fully sealed, two gallon cast aluminum reservoir.



| Model | Max PSI | HP | Wgt. | Fig. No. | Price |
|-------|----------------------|-----|------|----------|-------|
| LTS-1 | 8 | 1/3 | 30 | 9115 | |
| LTP-1 | 8 | 1/4 | 30 | 47184 | |
| L111A | switch assembly only | | | 9122 | |

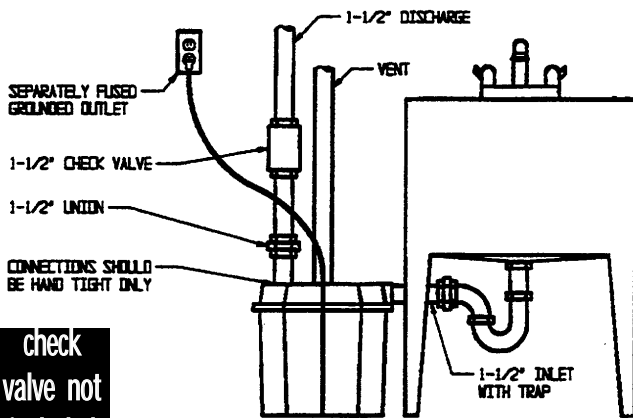

check valve not included

AUTOMATIC LAUNDRY TRAY/SINK/SHOWER PUMP

1/3 hp, 1-1/4" discharge for full flow, high output performance. Over 30 gpm at 10'. Corrosion-proof receiver is attractive and light in weight, with over 5-gallons capacity. safety features include double-insulated construction, automatic thermal overload protection and complete factory pre-wiring. Sealed, submersible pump and switch design eliminates the possibility of moisture damage. Unit can be even installed below floor level. Diameter 13-1/4", height 14-3/4" shipping wt. 27 lbs.

| FIG. NO. | PRICE |
|---------------|-------|
| COMPLETE UNIT | |
| 9125 | |



MODEL LP3A AUTOMATIC LAUNDRY TRAY PUMP

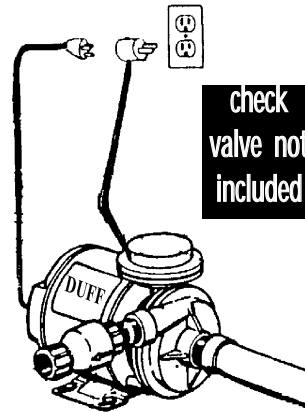

The control is a 15 Ampere heavy duty Microswitch manufactured by Minneapolis Honeywell Regulator Co. The diaphragm is made of heavy gauge neoprene, reinforced with nylon. A three way switch with Automatic off and manual settings. Also included is eight feet of three conductor electric cord and plug.

| FIG. NO. | PRICE |
|-------------|-------|
| 9132 | |
| SWITCH ONLY | |
| 18150 | |

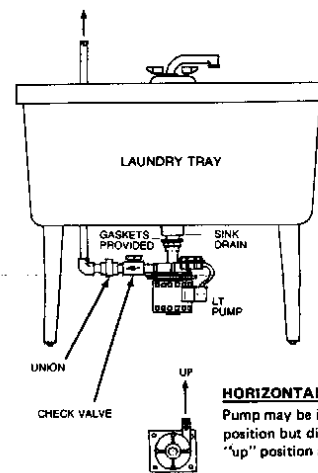

check valve not included



MODEL LTA-1 AUTOMATIC LAUNDRY TRAY PUMP

Completely self-contained unit that is easy to connect directly to laundry tray tubs. Light weight and compact, this model eliminates reservoirs, traps, extra fittings and costly labor. (Automatic model LTA-1 includes a pressure-activated switch that turns pump on when water enters tub.)

ABS plastic design features high impact & corrosion resistance, thus assuring long life. 1/8 hp motor, 1550 rpm. Inlet: 1 1/2" NPSM: Outlet: 1" NPT. Integral junction box.

| FIG. NO. | PRICE |
|----------|-------|
| 42878 | |

GRUNDFOS STAINLESS STEEL SEWAGE PUMPS

Technical Data

PERFORMANCE RANGE:

- Flow: 0 – 170 U.S. GPM
- Head: 0 – 47.5 feet of water
- Horsepower: 1/10 – 1 1/2 HP

SOLIDS HANDLING:

- 2" spherical solids

MOTOR TYPE:

- AC Induction
- Permanent split capacitor
- Oil filled
- Class F insulation
- Manufactured by Grundfos

MOTOR DUTY:

- Continuous, not to exceed 8 hours per 24 hour period

THERMAL PROTECTION:

- Automatic reset

STARTS PER HOUR:

- Maximum 20 starts per hour
- Evenly distributed once every 3 minutes

MOTOR BEARING SYSTEM:

- 2-ball bearing races

TEMPERATURE LIMITS: Fluid temperature

- Continuous operation when fully submerged
- 104°F (40° C)
- Intermittent operation (approx. 3-4 minutes)
- 140°F (60° C)

DISCHARGE SIZE: 2" female NPT

IMPELLER DESIGN:

- Vortex

APPROVALS: Listed 99K4

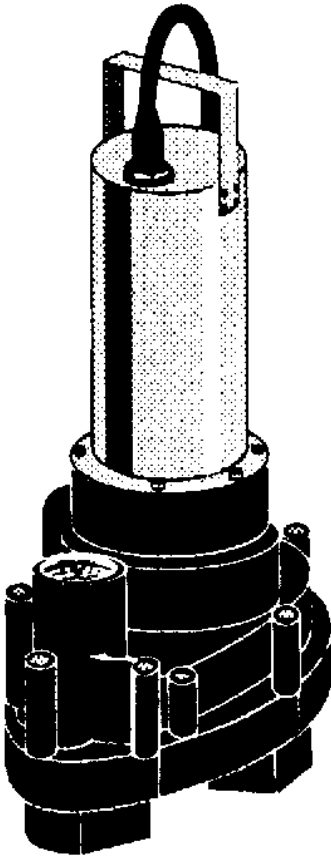

Performance Curve

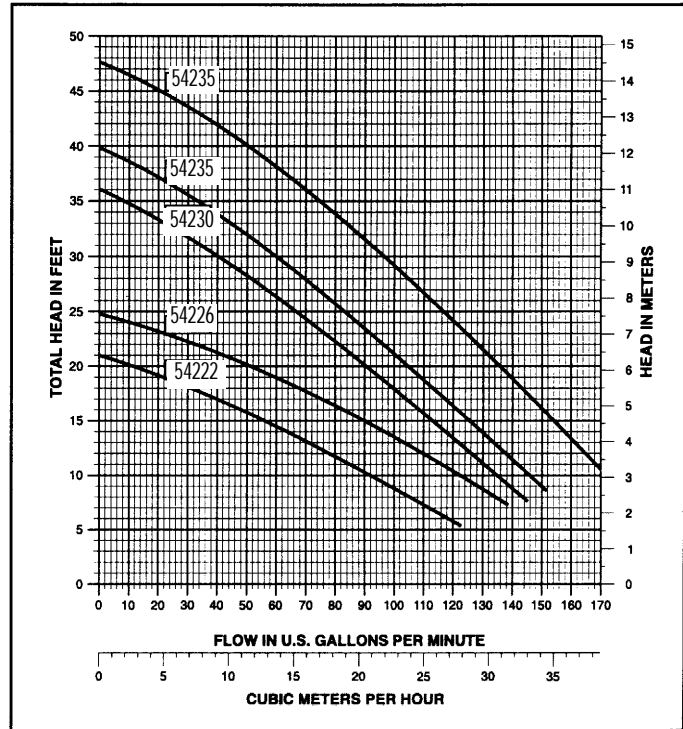

GRUNDFOS



Leaders in Pump Technology

| Figure No. | HP | Service Factor | PH | Voltage | Max Watts | MaxRun Amps | Locked RotorAmp | Nom Speed (rpm) | Price |
|------------|-------|----------------|----|---------|-----------|-------------|-----------------|-----------------|-------|
| 54222 | 4/10 | 1.4 | 1 | 115 | 935 | 8.7 | 18 | 1625 | |
| 54226 | 1/2 | 1.6 | 1 | 115 | 1155 | 11.2 | 24 | 1635 | |
| 54231 | 3/4 | 1.5 | 1 | 230 | 2155 | 9.7 | 23 | 3335 | |
| 54234 | 1 | 1.4 | 1 | 230 | 2290 | 10.3 | 23 | 3315 | |
| 54236 | 1 1/2 | 1.3 | 1 | 230 | 2890 | 13.1 | 30 | 3350 | |

For additional information call: 610-275-4453 or Fax: 610-279-6299

Please call for current prices.

PACKAGED RESIDENTIAL SEWAGE SYSTEM

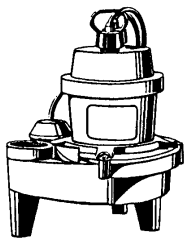

SEWAGE PUMP
2" solids, 115V, 1/2" IP

| FIG. NO. | PRICE |
|----------|-------|
| 9129 | |

used in #9130 assembly

1/2 hp 2" solids-handling 2" discharge

Features:

Heavy cast iron construction with 2-vane semi-open *HYTREL impeller

Oil filled, thermally protected motor

Permanently lubricated bearings

All stainless steel fasteners

Stainless steel rotor shaft

10' UL approved power cord with quick disconnect design - standard (consult factory for longer cord lengths)

Mercury-free float with series plug on automatic models

PERFORMANCE CURVE

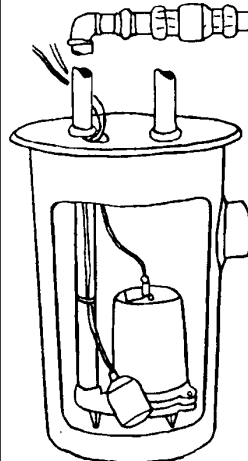
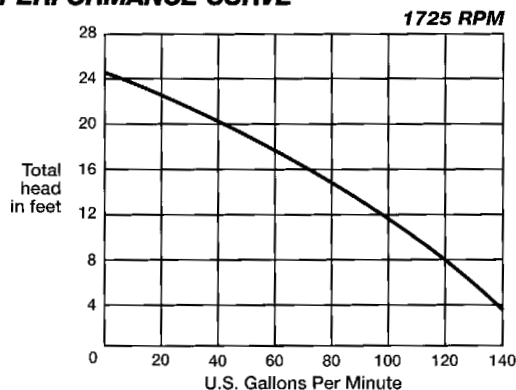

SEWAGE EJECTOR COMPLETELY PRE-ASSEMBLED

*2" Solid handling

*2" Discharge vent

*3" or 4" inlet

*Capacity 37 gallons

*For residential and light commercial installations (up to 60 fixture units).

Features:

Durable polyethylene basin with reinforcing ribs for structural strength; 20" x 30"

'Torque stops' molded into the base provide added pump stability and assure proper clearance for the float switch.

Molded inlet hub has no bolts or gaskets - sized for 4" flexible couplings

25% more capacity than 18"x30"basins - provided more gallons per pump cycle and longer pump and switch life

2" discharge of schedule 80 PVC pipe (steel pipe nipple optional)

2" threaded vent flange

Reinforced polyethylene over (steel cover optional)

COMPLETE UNIT

| FIG. NO. | PRICE |
|----------------------------|-------|
| 9130 | |
| 20 x 30 PIT AND LID | |
| 25111 | |

GRINDER SEWAGE PUMP

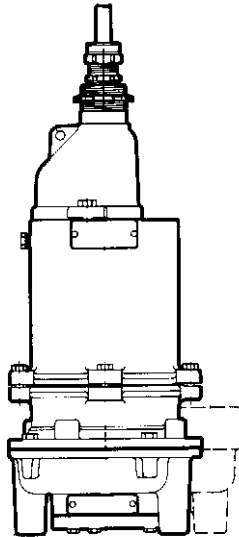

ADVANTAGES BY DESIGN

IDEAL FOR USE IN PRESSURE SEWER SYSTEMS.

- Recessed impeller provides steep non-overloading operating curve.

DURABLE MOTOR WILL DELIVER MANY YEARS OF RELIABLE SERVICE.

- Oil-filled motor for maximum heat dissipation and constant bearing lubrication.
- Recessed impeller reduces radial bearing loads, increases bearing life.
- High torque capacitor starts single phase or three phase motors for assured starting under heavy load.
- Optional seal leak probe warns of seal leak condition, helps prevent costly motor damage.
- Single phase motors have on-winding current and temperature sensitive overload.

COMPLETE GRINDER SEWAGE PUMP SYSTEM

GENERAL SPECIFICATIONS

| Pump | | Electrical | |
|-------------|---------|------------|------------------|
| Speed – RPM | 3450 | Voltage | 230 230 or 460 |
| Horsepower | 2 | Hertz | 60 60 |
| Weight | 71 lbs. | Phase | 1 3 |
| Height | 16 3/4" | Amps | 12.5 6.1/3.1 |
| Width | 11" | | |
| Discharge | 1 1/4" | | |

Basin Package

Basin:
30" x 36" or 24" x 42"
fiberglass; 34" or 28" epoxy
painted steel lid with 20"
inner cover

Control Box:
NEMA 4X control panel;
hand-off-automatic switch;
terminal strip; audible alarm,
thermal overload and
"sealminder"

Floats:
three encapsulated mercury
switches in polypropylene
housing; on, off, and alarm

Weight:
210 lbs. grinder pump system

WIRING PER SPECIFICATION

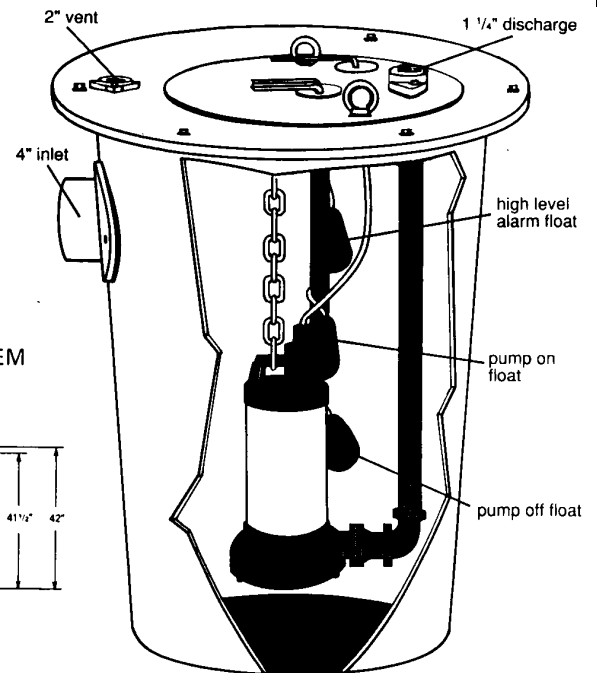

30" x 36" SYSTEM

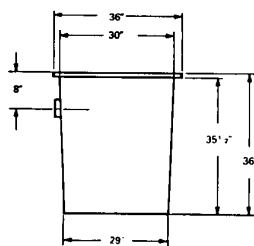

24" x 42" SYSTEM

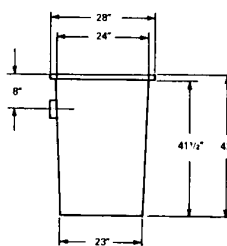

E F F L U E N T P U M P S
1 1/2" DISCHARGE

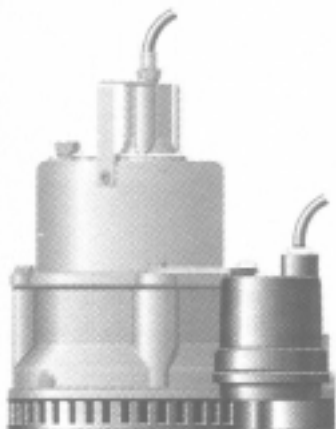

AURORA PUMP **G_S**
A UNIT OF GENERAL SIGNAL

HYDROMATIC SD25/33
Submersible Sump/Effluent Pump

| | | | | | | | | | | | | |
|--------------------------|---------------|-----------|-----------|-----------|-----------|-----------|-----------|-----------|-----------|-----------|-----------|-----------|
| Total Head (feet) | 4 | 6 | 8 | 10 | 12 | 14 | 16 | 18 | 20 | 22 | 24 | |
| GPM | 1/4 HP | 44 | 41 | 36 | 33 | 29 | 26 | 23 | 18 | 12 | 6 | 0 |
| | 1/3 HP | 47 | 45 | 43 | 40 | 37 | 34 | 30 | 26 | 22 | 16 | 10 |

| SIZE | FIG. NO. | PRICE |
|--------|----------|-------|
| 1/4 HP | 24898 | |
| 1/3 HP | 24899 | |

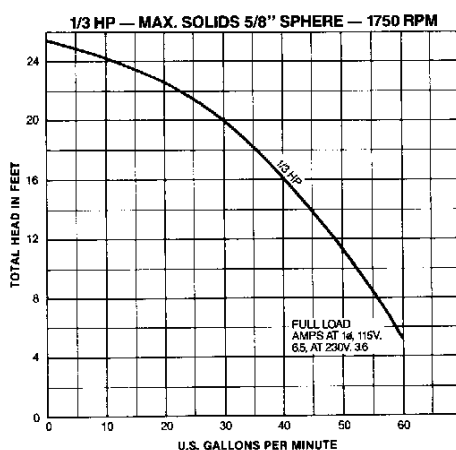

- Available in automatic or manual.
- Completely submersible.
- Non-clog bronze impeller.
- No suction screens to clean.
- Oil-filled, double ball bearing motor with built-in overload protection.
- Reliable diaphragm switch with piggyback plug-in.
- Rugged cast iron construction.
- Completely field serviceable.
- 1 1/2" NPT discharge.

| DESCRIPTION | FIG. NO. | PRICE |
|-------------------|----------|-------|
| Automatic OSP33A1 | 7897 | |
| Manual OSP33M1 | 7892 | |

S E W A G E E J E C T O R P U M P S
2" DISCHARGE

| | | | | | | | | |
|--------------------------|----------------|------------|------------|-----------|-----------|-----------|-----------|----------|
| Total Head (feet) | 4 | 8 | 12 | 16 | 20 | 24 | 28 | |
| GPM | 4/10 HP | 120 | 108 | 90 | 68 | 42 | 20 | 0 |

| DESCRIPTION | FIG. NO. | PRICE |
|-----------------|----------|-------|
| Automatic SP40A | 8000 | |
| Manual SP40M | 8016 | |

| | | | | | | | | |
|--------------------------|---------------|------------|------------|-----------|-----------|-----------|-----------|----------|
| Total Head (feet) | 8 | 12 | 16 | 20 | 24 | 28 | 29 | |
| GPM | 1/2 HP | 150 | 120 | 95 | 70 | 40 | 7 | 0 |

| DESCRIPTION | FIG. NO. | PRICE |
|-----------------|----------|-------|
| Automatic SP50A | 8030 | |
| Manual SP50M | 8053 | |



CONTROLS

PUMP SWITCHES - Pump switches designed to directly control pumps up to 1 HP at 120V and 2HP at 230V. Each of these switches has an adjustable pumping range and is available in various cord lengths, all with piggy back plug unless noted. Each pump switch is UL Listed and CSA Certified.

JUNIOR SUPER SINGLE

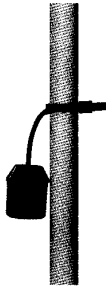

Mercury-activated
Controls pumps up to 1/2HP at 120V and 1HP at 230V
Not sensitive to rotation
Recommended for use in non-turbulent applications
Not designed to be directly wired to relays or motor contractors.
Pumping range: 5.5 to 17 inches
Available for pump up or pump down application.

| MODEL | FIG. NO. | PRICE |
|-------|----------|-------|
| JSD | 10883 | |
| JSU | 43320 | |

SUPER SINGLE

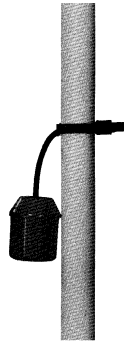

Mercury-activated
Controls pumps up to 1/2HP at 120V and 2HP at 230V
Not sensitive to rotation or turbulence
Suitable for use with intrinsically safe circuits
Pumping range: 5.5 to 15 inches
Available for pump up or pump down application.

| MODEL | FIG. NO. | PRICE |
|------------------------|----------|-------|
| SSD less plug 120/230v | 10875 | |
| SSD 120v | 10874 | |
| SSD 230v | 10878 | |
| SSU 120v | 45343 | |

DOUBLE FLOAT



Mercury-activated
Controls pumps up to 1 HP at 120V and 2HP at 230V
Not sensitive turbulence
Pumping range: 1 to 48 inches (wider ranges available)
Available for pump up or pump down application.

| MODEL | FIG. NO. | PRICE |
|--------------------|----------|-------|
| DFD 120V | 10884 | |
| DFU 120V | 41239 | |
| DFD 230V | 25278 | |
| DFU 230V | 41240 | |
| DFU 230V less plug | 58134 | |
| DFD 230V less plug | 50365 | |

DUPLIX ALTERNATING PUMP CONTROL SYSTEM

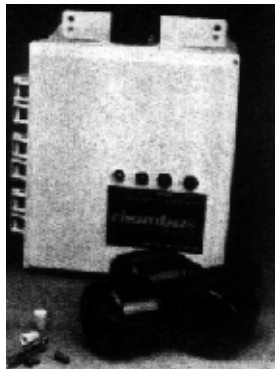

RHOMBUS TYPE 122 - Control panel is designed to alternately control two single-phase pumps in residential and commercial water and sewage systems. The alternating action equalizes pump wear. In addition to the alternating pump control, this system provides override control should either pump fail. If an alarm condition occurs, an alarm switch activates the audio/visual alarm system. Common applications include lift stations, pump chambers, sump pump basins and irrigation systems. One control for either indoor or outdoor use.

system. Common applications include lift stations, pump chambers, sump pump basins and irrigation systems. One control for either indoor or outdoor use.

| FIG. NO. | PRICE |
|----------|-------|
| 41559 | |

TANK ALERT 1

PUMP ALARM SYSTEM - Designed to visually and audibly warn of threatening high or low liquid level conditions in lift pump chambers, sump pump basins, holding tanks, sewage plus irrigation and other water systems. The standard alarm system includes a Tank Alert I and a sensor float control switch.



Designed for indoor use
Features horn and warning light
Switching mechanism operates on low voltage and is designed to reduce the possibility of shock
Includes optional auxiliary dry contacts for remote alarm hookup
UL Listed and CSA Certified

| FIG. NO. | PRICE |
|----------|-------|
| 10871 | |

**DUFF SELLS SOLUTIONS!
LET US HELP YOU!
610-275-4453**



LITTLE GIANT PUMPS

Small Submersible Pumps

Designed to operate when the pump is totally submerged in fluid, Little Giant Small Submersibles are hermetically sealed and filled with a special oil that provides lifetime lubrication and rapid dissipation of heat. The new 10EA series pump is epoxy encapsulated instead of oil filled.

FEATURES

Except where noted, all units feature:

- * Cast aluminum housing with protective epoxy coating.
- * 1/4" MNPT discharge
- * 6' power cord with 3 prong molded plug
- * Buna-N seal

Model P-AAA

Corrosion-resistant, glass filled nylon housing can be set on all five sides. Screen flush with pump side allows more complete pickup of fluid. Impedance protected. UL listed.

Model 1-AA

Polypropylene front and impeller, with polyethylene screen. 3' power cord with 3 prong molded plug.

Model 1-EA

Compact pump with epoxy encapsulated motor; case is constructed of cast aluminum and polyester. Volute, impeller and screen and polypropylene. Perfect for fresh water circulation/aeration in aquariums. Impedance protected. UL Listed.

Model PCPK-N (Pool Cover Pump)

For standing water removal from pool cover. Also ideal for use as a submersible pump in

waterfall, fountain, sump, bilge, pond and other applications.

Model 1-MA

Side intake and vertical discharge. Polypropylene front, impeller and screen. UL Listed.

Model 1

Polypropylene front and impeller, with polyethylene screen. UL Listed.

Model 1-A

Same as Model 1 above, with smaller motor. UL Listed.

Model 2E-N

Smooth, hooded intake with polypropylene screen. Vertical discharge. Thermally protected. UL Listed.

Model 4E-34N

Polypropylene screen. 3/4" FNPT intake and 1/2" MNPT discharge., Viton seal. Thermally protected. UL Listed.

Model NK-1

Designed for use in mild acids, alkalies and hard water applications. Has glass-filled corrosion-resistant nylon housing. Viton seal. Thermally protected.

Model NK-2

Same as above, with larger motor.



Dual Purpose Pumps

Little Giant dual purpose pumps may be used either totally submerged or in an open air closed line system application. Pumps are filled with a special oil that provides lifetime lubrication and rapid dissipation of heat. The new 1-EA 42 pump epoxy encapsulated instead of oil filled.

FEATURES

Except where noted, all units feature:

- * Cast aluminum housing with protective epoxy coating.
- * Threaded intake and discharge ports
- * Nylon pumping head and impeller
- * 6' power cord with 3 prong molded plug
- * Thermal overload protection
- * Buna-N Seal

Model 1-EA-42

Compact, submersible or in-line pump with epoxy-encapsulated motor; outer case is constructed of durable die cast aluminum and polyester. Volute and impeller are nylon. Impedance protected. Has both 1/2" MNPT and 1/4" FNPT intake ports and 1/4" MNPT discharge port. UL Listed.

Model 1-42A

Has both 1/2" MNPT and 1/4" FNPT intake ports, and 1/4" MNPT discharge port. UL Listed.

Model 1-42

Same as above with larger motor. UL Listed.

Model 2E-38N

3/8" FNPT intake and 1/4" MNPT discharge ports. Viton seal and stainless steel backplate. Used in Hot Tub and spa applications. 10' power cord.

Model 3E-12N

3/4" FNPT intake and 1/2" MNPT discharge ports. Nylon screen. Viton seal. UL Listed.

Model 3E-12NR

Same as Model 3E-12N, with heavy duty motor. UL Listed.

Model 3E-112R

Same as model 3E-12N, with high pressure impeller. UL Listed.

Small Submersible
Dual Purpose

| | Gallons Per Hour @ 115 VAC 60 Hz | | | Shut Off | PSI | Fig. No. |
|---------|-------------------------------------|----------|----------|-------------|------|-------------|
| | 1' 3' | 3' 5' | 5' 5' | | | |
| P-AAA | 120 | 70 | - | 4.6' | 2.0 | 11498 |
| 1-AA | 170 | 140 | 100 | 7.0' | 3.0 | 11500 |
| 1-A | 170 | 140 | 100 | 7.0' | 3.0 | 11502 |
| 1 | 205 | 168 | 120 | 7.4' | 3.2 | 11503 |
| NK-1 | 210 | 180 | 150 | 10.2' | 4.4 | 11514 |
| 2E-N | 300 | 255 | 205 | 11.8' | 5.1 | 11505 |
| NK-2 | 325 | 300 | 270 | 12.3' | 5.3 | 11515 |
| 4E-34N | 710 | 690 | 670 | 23.1 | 10.0 | 11512 |
| 4E-34NR | 810 | 790 | 745 | 24.5 | 10.6 | 11513 |
| PCPK-N | 325 | 300 | 270 | 12.3 | 5.3 | 11516 |
| 1-EA-42 | 170 | 100 | - | 7.0' | 3.0 | 47008 |
| 1-42 | 205 | 120 | - | 7.4' | 3.2 | 11507 |
| 2E-38N | 300 | 205 | 70 | 11.8' | 5.1 | 11508 |
| 3E-12N | 500 | 337 | 210 | 17.3' | 6.5 | 11509 |
| 3E-12NR | 670 | 575 | 460 | 22.6 | 9.8 | 11510 |
| 3E-12R | 525 | 490 | 450 | 25.9 | 11.2 | 38160 |
| 3E-34N | 670 | 575 | 460 | 20.3' | 8.8 | 11511 |

LITTLE GIANT CHEMICAL TRANSFER PUMPS

Magnetic Driven Pumps

Model 1-AA-MD

Employing a completely "seal-less" engineering concept, Little Giant Magnet Driven Centrifugal Pumps are specifically designed to handle acids, alkalis, solvents and other sophisticated fluid chemistry with efficiency and trouble-free reliability.

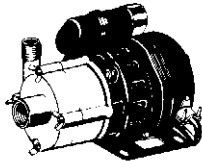
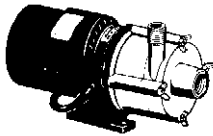
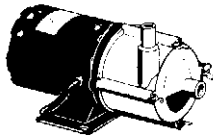
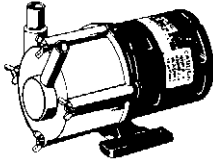

FEATURES

- Except where notes, all units feature:
- * Titanium shaft and thrust washers for excellent wear and corrosion resistance.
- * High quality, permanent, uncoated ceramic (barium ferrite) driven magnet.
- * Glass-filled polypropylene pumping head and impeller.
- * Nitrile O-ring.

FLUID SYSTEM DESIGN PARAMETERS

- * Specific gravity: Up to 1.1
- * Viscosity: Up to 100 SSU (20CPS)
- * Ambient Air Temperatures: up to 77 Deg Far (24 Deg C)

NOTE: CONSULT FACTORY FOR APPLICATIONS WITH HIGHER AMBIENT TEMPERATURE, SPECIFIC GRAVITIES AND VISCOSITIES.

FLUID/MATERIALS IN CONTACT

Poly propylene, Titanium, Barium Ferrite and Nitrile.

Model 1-MD

1/2" OD smooth discharge and intake ports. Open fan-cooled motor has sleeve bearings. Thermally protected. 6' power cord with 3 prong molded plug.

Model 2-MD

1/2" threaded MNPT discharge, and 1/2" threaded FNPT intake ports. Pen fan-cooled motor has sleeve bearings. Thermally protected. 6' power cord with 3 prong molded plug.

Model 3-MDX

5/6" OD smooth discharge and intake ports. Open fan-cooled motor has sleeve bearings. Thermally protected. 6' power cord with 3 prong molded plug.

Model 4-MD

Same features as Model 3-MD with larger motor.

Model 5-MD

1/2" threaded FNPT intake ports. Open fan-cooled PSC motor has sleeve bearings. Thermally protected. 6' power cord with 3 prong molded plug.

| MD Series Specifications | | | | | | | | | | | | | | | | | | | | | | |
|--------------------------|-------|-------------|-----------|-------|------|-------|-------|------|-------------|---------|---------------------|------------------|-----|-----|-----|-----|-----|-----|-----------------|-----|-----|-------------------|
| Model | Fig | Intake Size | Dis. Size | Motor | | | | | Motor Type | Max PSI | Shut Off Head (Ft.) | Gallons Per Hour | | | | | | | Dimensions (In) | | | Wt. Pack- ed Lbs. |
| | | | | Hertz | RPM | HP | Watts | Amps | | | | 1' | 3' | 6' | 9' | 15' | 18' | 24' | HT. | WD. | LG. | |
| 1-AA-MD* | 11544 | 1/2" OD | 1/2" OD | 60 | 3250 | 1/200 | 16 | .27 | OPEN | 2.35 | 5.4 | 180 | 100 | - | - | - | - | - | 3.7 | 2.4 | 4.4 | 1.5 |
| 1-MD* | 11546 | 1/2" OD | 1/2" OD | 60 | 2450 | 1/70 | 60 | .79 | OPEN FC | 4.6 | 10.8 | 180 | 165 | 90 | 20 | - | - | - | 5.0 | 4.0 | 8.3 | 4.0 |
| 2-MD | 11548 | 1/2" FNPT | 1/2" MNPT | 60 | 3100 | 1/30 | 100 | 1.5 | OPEN FC | 6.3 | 14.8 | 510 | 465 | 410 | 330 | - | - | - | 4.3 | 4.0 | 8.5 | 4.0 |
| | | | | 50 | 2600 | 1/30 | 105 | 1.7 | 4.5 | 10.5 | 470 | 420 | 350 | 200 | - | - | - | | | | | |
| 3-MDX | 11551 | 5/8" OD | 5/8" OD | 60 | 3150 | 1/30 | 100 | 1.7 | OPEN FC | 6.6 | 15.2 | 445 | 415 | 360 | 295 | - | - | - | 4.3 | 4.0 | 8.3 | 4.0 |
| | | | | 50 | 2850 | 1/30 | 95 | 1.5 | 4.8 | 11.1 | 415 | 385 | 290 | 180 | - | - | - | | | | | |
| 3-MI | 11552 | 1/2" FNPT | 1/2" MNPT | 60 | 3300 | 1/20 | 105 | 1.4 | OPEN FC | 7.1 | 18.3 | 590 | 545 | 490 | 390 | 150 | - | - | 4.3 | 4.0 | 8.5 | 7.0 |
| 4-MD* | 11554 | 1/2" FNPT | 1/2" MNP | 60 | 3250 | 1/12 | 213 | 2.4 | OPEN FC | 10.2 | 23.7 | 690 | 660 | 600 | 545 | 390 | 280 | - | 4.3 | 4.0 | 8.9 | 7.5 |
| | | | | 50 | 2800 | 1/8 | 155 | 1.9 | 9.7 | 22.4 | 945 | 905 | 800 | 715 | 530 | 440 | - | | | | | |
| 5-MD | 11556 | 1/2" FNPT | 1/2" MNP | 60 | 3250 | 1/8 | 200 | 2.1 | OPEN FC PSC | 15.0 | 34.8 | 905 | 875 | 800 | 750 | 635 | 575 | 440 | 5.6 | 5.4 | 8.3 | 8.8 |
| | | | | 50 | 2800 | 1/8 | 155 | 1.9 | 9.7 | 22.4 | 945 | 905 | 800 | 715 | 530 | 440 | - | | | | | |

LITTLE GIANT PUMPS

COLD WATER CONDENSATE PUMPS

An inexpensive, trouble-free solution to condensate removal where gravity drainage is impossible or impractical, Little Giant Automatic Condensate units are designed to fit most mechanical refrigeration and air conditioning units. Also for use in the disposal of waste water of Drinking Fountains, Humidifiers, Ice Makers, Beverage Machines and other applications.

Model 1-ABS

Designed for in-pan mounting, submersible pump has cast aluminum housing with protective epoxy coating, smooth intake and 1/4" MNPT discharge. Float operated switch is waterproof and engages pump in 1.06" of water, and disengages pump in .5" of water. Pump has 6' power cord, with 3 prong molded plug.

Model TKT

Nylon, corrosion-proof tank for use with Model 1-ABS pump unit. Kit consists of tank, check valve, and 20' of 1/4" tubing.

Model 2EC-SPT

Shallow pan tank unit for use where minimum height is a requirement. Pump has 1/4" MNPT discharge. Float operated switch engages pump in 2.25" of water, and disengages in 1.5" of water. Pump has 6' power cord with 3 prong molded plug.

Model 34C-SPT

Larger of the shallow pan tank units has greater pumping capacity. Pump has 1/2" MNPT discharge, 6' power cord with 3 prong molded plug. Pump engages in 4.45" of water, and disengages in 3.45" of water. Unit includes 3/8" check valve.

Suitable for High Efficiency Applications

For Condensate and waste water removal tasks, Little Giant vertical-pump Automatic Condensate Units are an efficient, low cost answer. Designed to fit most larger mechanical refrigeration and air conditioning units, these pump units also serve as excellent waste water disposal systems where increased volume is needed.

FEATURES

Except where noted, all units feature: Vertical type pump unit. Leakproof, rust-proof, high-impact polystyrene tank. ABS Motor & Tank cover, volute and impeller. Stainless steel shaft. Snap action Switch. 3/8" OD barbed discharge. 6' power cord with 3 prong molded plug. Thermal overload protection.

Model VCM-15UL

Pump engages in 2.40" of water, and disengages in 1.25" of water. Check valve. UL Listed.

Model VCM-15ULS

Same as above, but includes safety switch, and check valve. UL Listed.

Model VCM-20UL

Same as Model VCM-15UL above, with greater pumping capacity. Check Valve. UL Listed.

Model VCM-20ULS

Same as Model VCM-20UL, with safety switch, and check valve. UL Listed.

Model VCC-20ULS

Low-profile, compact size for limited space installations. Pump engages in 1" of water, and disengages in .45 of water. Includes safety switch and check valve.

Model VCL-14ULS

Pump engages in 3.56" of water, and disengages in 2.6" of water. Includes safety switch.

Model VCL-24UL

Same as above with larger motor. No safety switch. Thermally protected. UL Listed.

Model VCL-24ULS

Same as Model VCL-24UL above, with safety switch. UL Listed.

Model VCL-45S

Heavy duty pumping unit. Pump engages in 3.56" of water, and disengages in 2.6" of water. Will pump 75 GPH at 40' Head. 3' power cord, without plug. 3/8" OD copper tube discharge. Includes safety switch.

Coil Cleaning Kit

Model GKPK-SC

A fast inexpensive and effective system for "boiling out" coils, the Little Giant Coil Cleaning Kit is ideal for use with steam converters, burnouts, shell and tube head exchangers, water heaters and oil supply lines to fuel oil heaters. Used with coil cleaning acids. Kit includes 5 gallon polyethylene tank with cover and baffle, and Little Giant Model 2-MD-SC (Special Version #582523) magnet-driven pump with mounting bracket. Also includes 18' of 1/2" Tygon tubing, 10'.

| | Gallons per hour @ 115 VAC 60 HZ | | | SHUT OFF | PSI | FIG. NO. |
|-------------|----------------------------------|-----|-----|----------|------|----------|
| | 1' | 5' | 9' | | | |
| 1-ABS | 205 | 145 | - | 10' | 4.3 | 11517 |
| VCC-20ULS | 70* | 55* | - | 20' | 8.6 | 43186 |
| VCM-15UL(S) | 50* | 30* | - | 15' | 6.5 | 30238 |
| VCM-20UL(S) | 701* | 55* | - | 20' | 8.6 | 38162 |
| VCL-14UL(S) | 170 | 125 | - | 14' | 6.1 | 16965 |
| VCL24-UL(S) | 250 | 210 | 105 | 24' | 10.4 | 30244 |
| VCL-45S | 440 | 415 | 330 | 45' | 10.5 | 30245 |
| GKPK-SC | 310 | 285 | 225 | 14.6' | 6.5 | 18146 |

*GPH RATES SHOWN ARE WITH CHECK VALVES.

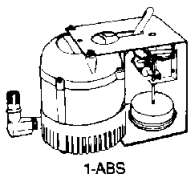

1-ABS

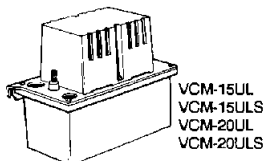

VCM-15UL
VCM-15ULS
VCM-20UL
VCM-20ULS

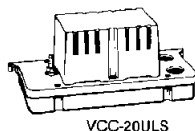

VCC-20ULS

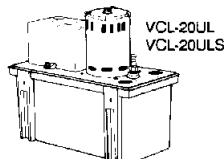

VCL-20UL
VCL-20ULS

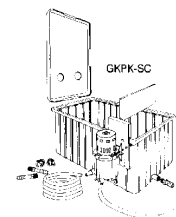

GKPK-SC

LOOKING FOR REPAIR PARTS FOR YOUR PUMPS?

CALL DUFF!

WE CAN SUPPLY YOU WITH PARTS FOR ANY BRAND PUMP!

ARMSTRONG

AMTROL INC.

P A C O

GRUNDFOS
Leaders in Pump Technology

Myers **ZOELLER CO.**

Liberty Pumps™

JACUZZI

Little Giant
PUMP COMPANY
SUBSIDIARY
TECUMSEH PRODUCTS COMPANY

STA-RITE

RED JACKET

COVERT
PUMP DIVISION

ABS

GOULDS PUMPS, INC.
WATER TECHNOLOGIES GROUP
SENECA FALLS, NEW YORK 13148

BARNES PUMPS

THRUSH

Bell & Gossett
ITT Fluid Technology Corporation

TACO

AURORA

BARNES PUMPS

mud 'n sludge

DIAPHRAGM

PUMPS

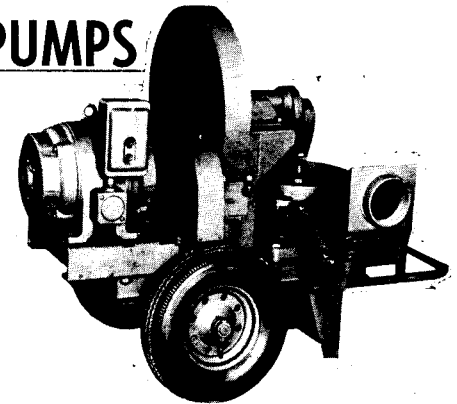

PERFORMANCE

| MODEL NO. | HEIGHT OF PUMP ABOVE WATER | | | | |
|-----------|----------------------------|------|------|------|------|
| | 5' | 10' | 15' | 20' | 25' |
| 20ADG | 3760 | 3720 | 3600 | 3480 | 3420 |
| 30ADG | 4380 | 4080 | 3960 | 3840 | 3780 |
| 30ADD | 4380 | 4080 | 3960 | 3840 | 3780 |
| 4CDG | 8000 | 8000 | 6000 | 4000 | 2000 |
| 2CDE | 3000 | 2500 | 2000 | 1500 | 1250 |
| 3CDE | 6000 | 5500 | 4500 | 3500 | 3000 |
| 4CDE | 8000 | 8000 | 6000 | 4000 | 2000 |
| 20CDE | 1680 | 1560 | 1320 | 1140 | 900 |

U.S. GALLONS PER HOUR

NOTE: Above Performance Based on 10' Static Discharge Head.

**FOR EXACT MODEL
SPECIFICATIONS & PRICES
CALL DUFF
610-275-4453**

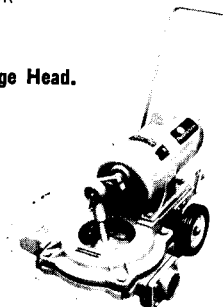

- * 2", 3" and 4" sizes with capacities to 8,000 GPH to handle slurry, sludge and residue.
- * Lightweight, compact, minimum overall dimensions.
- * Economical—low original cost, easy maintenance.
- * Flexible coupled engine for easy replacement.
- * Simple construction—enclosed gear reduction, hardened, heat-treated and ground shaft, heavy-duty bearings on pump shaft and plunger crank.
- * Easy diaphragm replacement without disturbing suction or discharge lines.
- * Free-opening flap valves—large rubber-faced swing-type valves offer easy passage of foreign materials.

GENERAL PURPOSE CENTRIFUGAL PUMPS



J Series pump and other Sta-Rite centrifugal pumps can be ordered with 50 cycle motors and with other design characteristics. Call Duff for complete information on Sta-Rite centrifugal pumps for specific applications... on other equipment... or for any specific installation requirements.

- *1/3 to 2 1/2 HP - in either high head or medium head models, with heavy duty motors, easy service design, four position discharge and air volume control tapping.
- *Easy Serviceability - All models include replaceable wear ring and feature back pull-out design.
- *Medium Head - Models deliver up to 110' of head with capacities to 140 GPM.
- *High Head - Models deliver up to 140' of head with capacities to 90 GPM.
- *J Series Feature Lexan Impellers - Abrasion-resistant for normal applications, with working temperatures to 140 Deg. F.
- *JB Series Feature Brass Impellers - for temperature applications up to 225 deg F. (JB Pumps also equipped with high temperature shaft seals).



MEDIUM HEAD

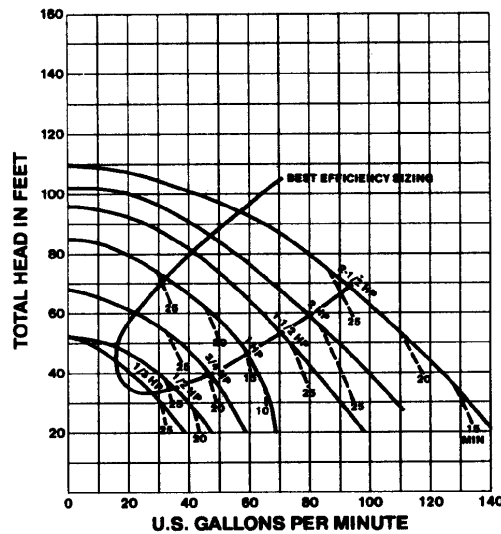

HIGH HEAD

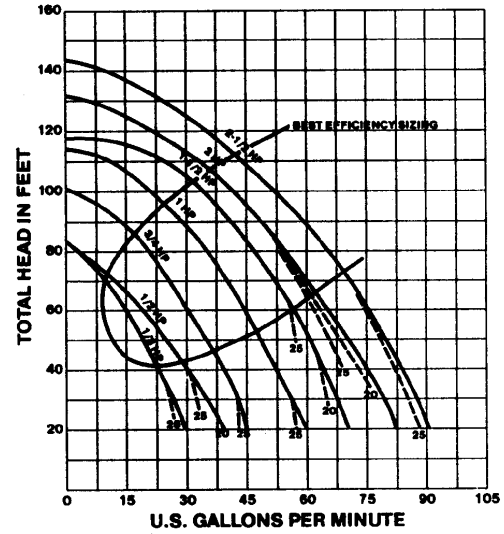

NOTE: Dotted lines indicate performance reduction at high suction lift.

MEDIUM HEAD

| HP | Lexan Impeller | Brass Impeller | Motor Voltage | Phase | Suct. | Disch. | Price |
|-------|----------------|----------------|---------------|-------|-------|--------|-------|
| 1/3 | 10060 | 10552 | 115/230 | 1 | 1 | 1" | |
| 1/2 | 10121 | 10575 | 115/230 | 1 | 1/4" | 1" | |
| 1/2 | 10434 | 10581 | 230/460 | 3 | 1 | 1" | |
| 3/4 | 10440 | 10587 | 115/230 | 1 | 1/4" | 1" | |
| 3/4 | 10446 | 10593 | 230/460 | 3 | 1 | 1" | |
| 1 | 10456 | 10596 | 115/230 | 1 | 1/4" | 1" | |
| 1 | 10468 | 10599 | 230/460 | 3 | 1 | 1" | |
| 1 1/2 | 10476 | 10603 | 115/230 | 1 | 1/4" | 1" | |
| 1 1/2 | 10484 | 10611 | 230/460 | 3 | 1 | 1" | |
| 2 | 10492 | 10615 | 115/230 | 1 | 1/4" | 1" | |
| 2 | 10504 | 10618 | 230/460 | 3 | 1 | 1/4" | |

HIGH HEAD

| HP | Lexan Impeller | Brass Impeller | Motor Voltage | Phase | Suct. | Disch. | Price |
|-------|----------------|----------------|---------------|-------|-------|--------|-------|
| 1/3 | 9799 | 9869 | 115/230 | 1 | 1 | 1" | |
| 1/2 | 9814 | 9877 | 115/230 | 1 | 1/4" | 1" | |
| 1/2 | 9819 | 9881 | 230/460 | 3 | 1 | 1" | |
| 3/4 | 9822 | 9898 | 115/230 | 1 | 1/4" | 1" | |
| 3/4 | 9828 | 9907 | 230/460 | 3 | 1 | 1" | |
| 1 | 9832 | 9913 | 115/230 | 1 | 1/4" | 1" | |
| 1 | 9836 | 9921 | 230/460 | 3 | 1 | 1" | |
| 1 1/2 | 9845 | 9925 | 115/230 | 1 | 1/4" | 1" | |
| 1 1/2 | 9847 | 9930 | 230/460 | 3 | 1 | 1" | |
| 2 | 9853 | 49020 | 115/230 | 1 | 1/4" | 1" | |
| 2 | 9856 | 49021 | 230/460 | 3 | 1 | 1/4" | |
| 2 1/2 | 9858 | 10036 | 115/230 | 1 | 1/4" | 1" | |
| 2 1/2 | 9864 | 10052 | 230/460 | 3 | 1 | 1/4" | |

JACUZZI PUMPS

POOL, SPA & CHEMICAL TRANSFER

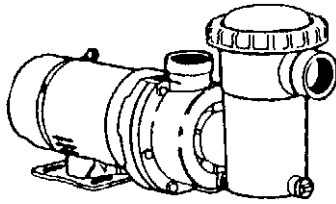

**EASY RING-LOK
BASKET STRAINER**

This self-priming centrifugal pump is suitable for use with saltwater, chemical transfer, and other applications that deal with corrosive substances.

Pumps available 1/2 HP through 3 HP.

115/230 Single Phase

208-230/460 Three Phase

MAGNUM Plus



POOL, SPA & CHEMICAL TRANSFER

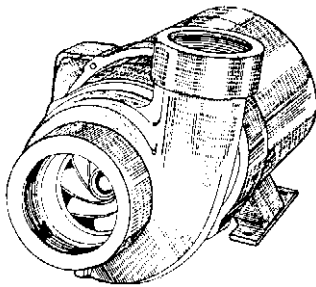

This flooded suction centrifugal pump is suitable for use with saltwater, chemical transfer and other applications that deal with corrosive substances.

1-1/2" MPT fits to accept a standard Jacuzzi union or male pipe thread.

Pumps available 3/4 HP through 2 HP.

115 volts.



END SUCTION CENTRIFUGAL PUMP

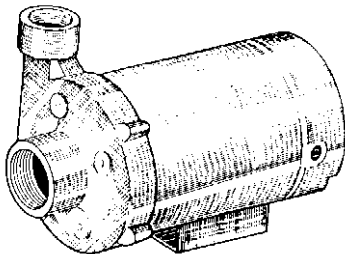

For general industrial use, transfer, circulation or booster service. Available in ratings from 1/3 HP to 50 HP with capacities through 650 GPM and heads to 300 feet.

Heavy duty cast iron construction mechanical shaft seal handles. Water temperature up to 212°F.

All voltages available.

HIGH PRESSURE BOOSTER PUMP

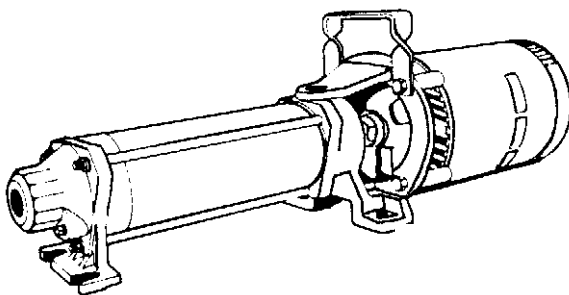

This multi-purpose pump is ideal for boosting water pressure around the home, industry or farm and is constructed with field-proven SandHandler hydraulics. Available in a variety of sizes for many applications 1/3-3HP and 5, 10, 18 and 25 GPM performance ranges.

Making a Difference.

JACUZZI.

BERKLEY PUMPS

CENTRIFUGAL PUMPS

Berkeley provides a complete line of motor driven centrifugal pumps, water-cooled and air-cooled engine driven pumps, belt and coupling drives, and Tracto-Rain pumps for use with tractor power take-offs. Capacities up to 3700 GPM. These centrifugal pumps are also available in modified designs with special materials, or can be custom designed and manufactured to meet specific application requirements. The reliability of Berkeley centrifugals has been proved in thousands of installations.



VERTICAL AND SUBMERSIBLE TURBINES

The Berkeley deepwell turbine line includes the 3450 RPM Cavalier, vertical turbine fire pumps listed by Underwriters Laboratories (with 500 to 2500 GPM capacities) and enclosed line oil-lubricated, or open line water-lubricated shaft types. Submersible Turbines for 6 inch and larger wells are also available. Dependable Berkeley turbines meet the most rigid requirements for agricultural, commercial, industrial and municipal applications.



DEEPWELL TURBINES

For 4 to 24 Inch Wells
Capacities from 25 to 12,000 gallons per minute, at pumping levels to 1000 feet deep. Water-lubricated open line and oil-lubricated enclosed line shafts. Motor, pulley and gear drives, and combination drives also available.



NON-CLOG PUMPS

Available for wet pit installation in conventional and submersible types. For dry pit applications available for motor, engine, belt or coupling drive. Suction and discharge from 2 1/2" to 6", Motors to 15 HP.

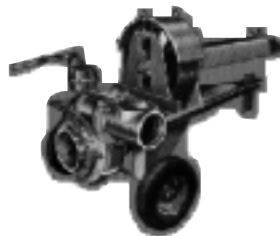

PTO PUMPS

Trailer mounted pumping units powered by tractor takeoff. Pump may be tailored to application by choice of 5 step-up drive sizes. Capacities 300 to 2200 GPM with pressures up to 100 psi. Designed specifically for sprinkler and flood irrigation applications. In 3" through 6" sizes.



2-STAGE CENTRIFUGAL

Higher pressures for fire, industrial, farm and general application. Motor, belt, or engine drive. Capacities 30 to 400 GPM with heads up to 650 feet, 1 to 40 HP. Maximum case pressures from 250 to 350 psi.



**GRUNDFOS SERIES C
CENTRIFUGAL PUMP**

Boiler Feed Water and Condensate Return * Dearation * Jockey Pumps for Fire Protection
* Water Treatment: RO, DI and Filtration * Car Wash Systems * Electronic Manufacturing
* Parts Washers * Lumber and Mining * Petrochemical: Refinery and Offshore

Available 1/2 HP through 40 HP
Available 5-400 gpm



TEFC AVAILABLE!

ALL VOLTAGES AVAILABLE!

**GRUNDFOS VERSAFLO UPS, TP, LM & LP SERIES
INLINE CIRCULATOR**



HVAC * Cooling Towers * Food Processing - Cooling * Agriculture *
Greenhouse & Hydroponics * Liquid Transfer * Commercial -
Industrial * Boiler Condensate * HVAC Hot and Chilled Water * Hot
water Recirculation * Industrial Applications

Available 1/2 HP through 20 HP
Available 25-380 gpm



TEFC AVAILABLE!

ALL VOLTAGES AVAILABLE!

**GRUNDFOS SERIES HS
CENTRIFUGAL PUMP**

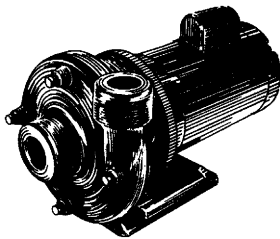

Water Circulation * Booster Service * Liquid Transfer * Air Conditioning * Water
Supply * Filter Systems * Water Fountains * Cooling Machinery * Light
Irrigation

Available 1/2 HP through 7-1/2 HP
Available 10-180 gpm

**OPEN DRIP PROOF & TEFC
MOTORS AVAILABLE!**

ALL VOLTAGES AVAILABLE!



Leaders in Pump Technology

BOOSTERPAQ For Booster Applications High-pressure booster systems

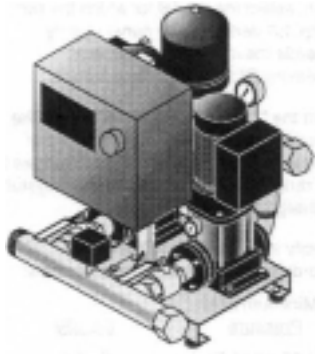

BOOSTER PUMPS

BoosterpaQ Features/Benefits

- **Grundfos MGE, integrated variable frequency drive motors** - Provide much better system efficiency and pressure regulation than constant speed systems which use pressure control valves. MGE motors do not require a separate VFD package and are very quiet and compact.
- **PFU2000/9 controller** - It is extremely simple to set the BoosterpaQ operating pressure. Simply adjust the potentiometer mounted on the PFU2000/9 until the pressure gauge reads the required pressure and your system is ready to maintain constant pressure over a wide range of flow demands. The inlet pressure switch provides low suction pressure and dry run protection. System status is easy to interpret (2 LEDs on the front panel), and an output alarm relay will trigger your alarm when the system needs attention.
- **Control Panel** - The control panel is CUL Listed. The enclosure standard is NEMA 3R, options available.
- **Grundfos vertical centrifugal pumps** - Grundfos multi-stage centrifugal pumps, models CRU (304 stainless and cast iron wetted parts) and CRNG (316 stainless wetted parts), provide a very small foot print package while offering high boosting pressures.
- **Two system configurations offered as standard** - All models feature stainless steel base frame and control panel mount and a diaphragm tank. In addition, you select from either of the following standard system configurations:

Grundfos CRU model pumps with 304 stainless steel materials for piping, manifolds, and valves or:

Grundfos CRNG model pumps with all 316 stainless steel materials for piping, manifolds, and valves.
- **Outdoor protective housing** - Available as an option.



COMPACT MULT-STAGE CENTRIFUGAL PUMPS FOR MACHINE TOOL COOLANTS, EDM, INDUSTRIAL PARTS WASHERS AND BOILER CONDENSATE APPLICATIONS



SPK/CRK/CHK

Model Range

| Models | HP Range | Discharge | Flow Range (GPM) |
|--------|------------------------------------|-----------|------------------|
| CHK2 | 1/2, 3/4, 1, 1-1/2, 2 | 3/4" | 1.2-16 |
| CHK4 | 3/4, 1, 1-1/2, 2, | 3/4" | 3-40 |
| SPK1 | 1/6, 1/4, 1/3, 1/2, 3/4, 1, 1-1/2 | 1-1/4" | 1-8 |
| SPK2 | 1/6, 1/4, 1/3, 1/2, 3/4, 1, 1-1/2 | 1-1/4" | 3-13 |
| SPK4 | 1/6, 1/4, 1/3, 1/2, 3/4, 1, 1-1/2 | 1-1/4" | 9-26 |
| SPK8 | 1/3, 1/2, 3/4, 1, 1-1/2 | 1-1/4" | 20-50 |
| CRK2 | 1/2, 3/4, 1, 1-1/2, 2, 3, 5 | 1-1/4" | 1.2-20 |
| CRK4 | 1/2, 3/4, 1-1/2, 2, 3, 5 | 1-1/4" | 3-40 |
| CRK8 | 3/4, 1, 1-1/2, 3, 5, 7-1/2, 10, 15 | 2" | 5.3-65 |
| CRK16 | 2, 5, 7-1/2, 10, 15, 20, 25 | 2" | 8.5-115 |

* 3/4" for SPK Mini

Materials of Construction

| Description | Material |
|--|--|
| Shaft | 431 Stainless Steel (SPK/CHK) 316 Stainless Steel (CRK) |
| Impeller, Chambers, Suction Interconnector, Priming Screw, Strainer and Straps | 304 Stainless Steel |
| Motor Stool, Coupling | Cast Iron* (304 S.S. optional some models) |
| Seal Faces (CRK) | Carbon/Tungsten Carbide |
| Seal Faces (SPK, CHK) | Carbon/Ceramic |
| Intermediate Bearing | Ceramic |
| Bearing Rings | Tungsten Carbide |
| Impeller Seal Ring, Neck Ring (CHK) | Ryton®/Teflon® |
| O-Ring | FPM |

Ryton® is a registered trademark of Phillips Petroleum.
Teflon® is a registered trademark of Dupont.

BELL & GOSSETT ITT CENTRIFUGAL PUMPS

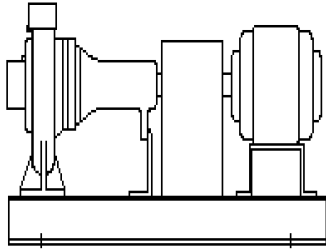
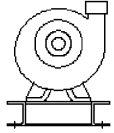

B&G Series 1510 Pumps
to 2500 GPM, 400 ft. Head, 100 HP
 Single stage, vertical split-case design. Can be used for open or closed systems. Seal options: standard mechanical, flushed single or double and packing.

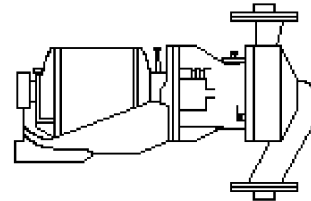

B&G Series 80 In-Line Pumps
to 2500 GPM, 375 ft. Head, 60 HP
 Compact vertical design saves space. Vertical or horizontal mounting in pipe saves installation time. Seal options: standard mechanical, flushed single or double and packing.

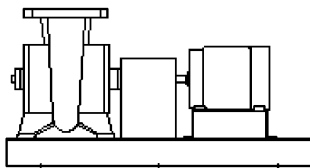
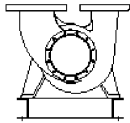

B&G Series VSC Pumps
to 4000 GPM, 400 ft. Head, 200 HP
 Single stage, double suction pump, saves up to 50% of floor space. Cuts piping requirements. Easily serviced without disturbing volute or motor. Seal options: standard mechanical, flushed single or double and packing.

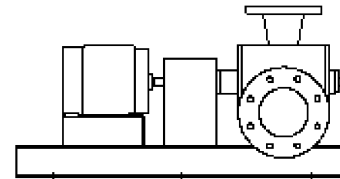
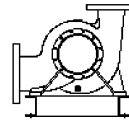

B&G Series VSCS PUMPS
to 8000 GPM, 300 ft. Head, 2500 HP
 Single stage, double suction pump same as VSC series except with side suction and top discharge.



**CALL DUFF NOW FOR YOUR
 PRICING AND AVAILABILITY!
 610-275-4453**

BELL & GOSSETT ITT CENTRIFUGAL PUMPS

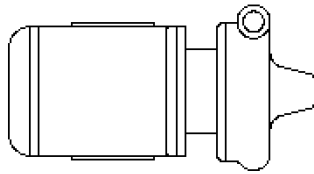
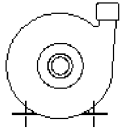

B&G Series 1535 Pumps to 2300 GPM, 400 ft. Head, 50 HP

Uni-built close-coupled pump ruggedly constructed. Heavy duty motor has extra large shaft and oversized ball bearings and is available as open, enclosed or explosion-proof units. Serviceable without breaking pipe connections. Seal options: standard mechanical, flushed single or double and packing.

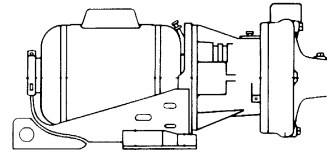
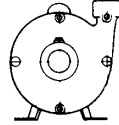

B&G Series 1522 Pumps to 140 GPM, 110 ft. Head, 2 HP

Ideal pump for cooling lower circulation and other refrigeration applications. Also extensively used as water pressure booster and industrial pumping duties. Amazingly quiet. Both pump and motor have bronze sleeve bearings. Time proven mechanical seal ends leakage troubles.

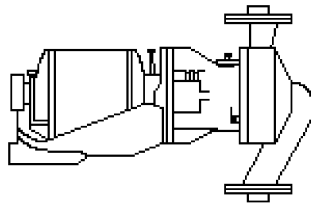

B&G Series 60 In-Line Pumps to 140 GPM, 56 ft. Head, 2 HP

Compact space saving design with many exclusive B&G features. Quality sleeve bearing construction assures quiet trouble-free operation. Vertical split case construction design provides easy servicing. In-line mounting simplifies installation.

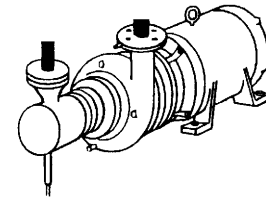

B&G Series 1531 Pumps to 2300 GPM, 400 ft. Head, 50 HP

Uni-built close coupled pump ruggedly constructed. Heavy duty motor has extra large shaft and oversize ball bearings and is available as open, enclosed or explosion proof units. Serviceable without breaking pipe connections. Seal options: standard mechanical, flushed single or double and packing.

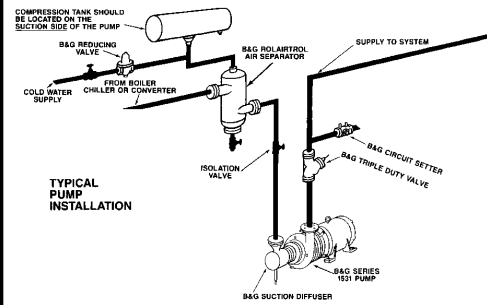

U S SEALS

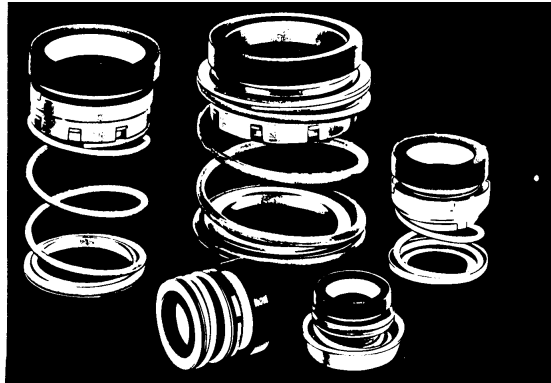

**COMPLETE STOCK!
CALL WITH YOUR
REQUIREMENTS!
WE CAN MATCH ANY SAMPLE!**

COME VISIT US!

**YOU ARE ALWAYS WELCOME AT
DUFF COMPANY!
201 EAST LAFAYETTE STREET
NORRISTOWN, PA**



LOVEJOY COUPLINGS

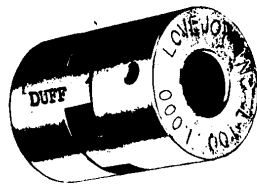

TYPE L

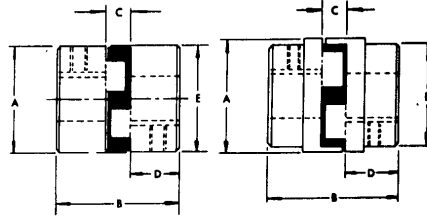

Style 1

Style 2

*Must have shaft size
of driver and driven!*

**SEE
HEATING
SECTION
FOR
WOODS
AND B&G
COUPLINGS**

| Style # | BORE | | DIMENSION IN INCHES | | | | | Complete Coupling | Spider | | |
|---------|------|--------|---------------------|--------------------|--------------------------|----------------------|-------------|-------------------|--------|----------|-------|
| | Min | Max | Outside Dia (A) | Overall Length (B) | Distance bwn flanges (C) | Length thru bore (D) | Hub Dia (E) | Fig. No. | Price | Fig. No. | Price |
| 1 | 1/8 | 3/8 | 5/8 | 13/16 | 9/32 | 17/64 | 5/8 | 10779 | | 10788 | |
| 1 | 1/4 | 5/8 | 1 5/64 | 1 23/32 | 15/32 | 5/8 | 1 5/64 | 10783 | | 10790 | |
| 1 | 1/4 | 3/4 | 1 23/64 | 2 | 1/2 | 3/4 | 1 23/64 | 10786 | | 10793 | |
| 1 | 1/4 | 7/8 | 1 3/4 | 2 1/8 | 1/2 | 13/16 | 1 3/4 | 10752 | | 10797 | |
| 1 | 1/4 | 1 | 2 7/64 | 2 1/8 | 1/2 | 13/16 | 2 7/64 | 47660 | | 39908 | |
| 1 | 7/16 | 1 1/8 | 2 7/64 | 2 1/2 | 1/2 | 1 | 2 7/64 | 10756 | | 10799 | |
| 1 | 1/2 | 1 3/16 | 2 17/32 | 2 7/8 | 3/4 | 1 1/16 | 2 17/32 | 10762 | | 10802 | |
| 1 | 1/2 | 1 3/8 | 2 17/32 | 3 1/2 | 3/4 | 1 3/8 | 2 17/32 | 10763 | | 10807 | |
| 1 | 5/8 | 1 5/8 | 3 5/16 | 4 1/4 | 7/8 | 1 11/16 | 3 5/16 | 10769 | | 10809 | |
| 1 | 5/8 | 1 7/8 | 3 3/4 | 4 1/2 | 1 | 1 3/4 | 3 3/4 | 10772 | | 10813 | |
| 2 | 3/4 | 2 1/8 | 4 1/2 | 5 1/4 | 1 | 2 1/8 | 4 | 10775 | | 10816 | |
| 2 | 3/4 | 2 5/8 | 5 | 6 | 1 | 2 1/2 | 4 1/4 | 10778 | | 10819 | |

For additional information call: 610-275-4453 or Fax: 610-279-6299
Please call for current prices.

PUMPTROL

**PUMPTROL® COMMERCIAL/LIGHT INDUSTRIAL PRESSURE SWITCHES
- TYPES G**

Reference Page #CP8-16 - Square D Mini Catalogue
INDIVIDUALLY BOXED

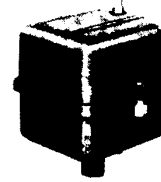

PART NUMBER

| CLASS | TYPE | CODE | FORM | PRES SETTING CLOSE-OPEN | CONNECTION/DESCRIPTION |
|-------|------|------|------|----------------------------|---|
| 9013 | GHG2 | J25 | | 60 - 80 | 1/4" FPT-EEMAC 1 - GENERAL PURPOSE |
| 9013 | GHG2 | J30 | R | 80 - 100 | 1/4" FPT-EEMAC 1 - REVERSE ACTION |
| 9013 | GHG5 | J65 | | 215 - 250 | 1/4" FPT-EEMAC 1 - GENERAL PURPOSE |
| 9013 | GHB2 | J30 | | 80 - 100 | 1/4" FPT-EEMAC 3R - RAINPROOF |
| 9013 | GHG2 | J30 | | 80 - 100 | 1/4" FPT-EEMAC 1 - GENERAL PURPOSE |
| 9013 | GHG2 | J51 | R | 100 - 80 | 1/4" FPT-EEMAC 1 - GEN PUR - REVERSE ACTION |
| 9013 | GHG2 | J30 | X | 80 - 100 | 1/4" FPT-EEMAC 1 - TWO WAY PRES. RELEASE |
| 9013 | GHR2 | J30 | | 80 - 100 | 1/4" FPT-EEMAC 7 & 9 - HAZARDOUS LOCATIONS |
| 9013 | GHW2 | J30 | | 80 - 100 | 1/4" FPT-EEMAC 4 - WATERTIGHT |
| 9013 | GSB2 | J24 | | 40 - 60 | 1/4" FPT-EEMAC 3R - RAINPROOF |
| 9013 | GSG2 | J20 | | 20 - 40 | 1/4" FPT-EEMAC 1 - GENERAL PURPOSE |
| 9013 | GSG2 | J21 | | 30 - 50 | 1/4" FPT-EEMAC 1 - GENERAL PURPOSE |
| 9013 | GSG2 | J24 | | 40 - 60 | 1/4" FPT-EEMAC 1 - GENERAL PURPOSE |
| 9013 | GSG2 | J24 | R | 40 - 60 | 1/4" FPT-EEMAC 1 - REVERSE ACTION |
| 9013 | GSG2 | J25 | | 60 - 80 | 1/4" FPT-EEMAC 1 - GENERAL PURPOSE |
| 9013 | GSG2 | J99 | R | 60 - 40 | 1/4" FPT-EEMAC 1 - REVERSE ACTION |
| 9013 | GSG2 | J24 | X | 40 - 60 | 1/4" FPT-EEMAC 1 - TWO WAY PRES. RELEASE |
| 9013 | GSR2 | J20 | | 20 - 40 | 1/4" FPT-EEMAC 7 & 9 - HAZARDOUS LOCATIONS |
| 9013 | GSR2 | J24 | | 40 - 60 | 1/4" FPT-EEMAC 7 & 9 - HAZARDOUS LOCATIONS |
| 9013 | GSW2 | J24 | | 40 - 60 | 1/4" FPT-EEMAC 4 - WATERTIGHT |

ACCESSORIES

9998PC205
9998PC208

CONTACTS - GHG, GSG, GHR, GSR, GMG
DIAPHRAGM ASSEMBLY - GHG, GSG

FLOAT SWITCHES - TYPE D - OPEN TANK OR SUMP - CLASS 9035

Reference Page #CP8-23 - Square D Mini Catalogue
INDIVIDUALLY BOXED



PRICE UPON REQUEST

FLOAT SWITCHES - TYPES D & G - OPEN TANK OR SUMP - CLASS 9036

Reference Page #CP8-24 - Square D Mini Catalogue
INDIVIDUALLY BOXED

PART NUMBER

| CLASS | TYPE | CODE | FORM | CONNECTION/DESCRIPTION |
|-------|------|------|------|---|
| 9036 | DG2 | | | EEMAC 1 - CONTACTS CLOSE ON LIQUID RISE |
| 9036 | DG2 | | R | EEMAC 1 - CONTACTS OPEN ON LIQUID RISE |
| 9036 | GG2 | | | EEMAC 1 - CONTACTS CLOSE ON LIQUID RISE |
| 9036 | GG2 | | R | EEMAC 1 - CONTACTS OPEN ON LIQUID RISE |
| 9036 | DW31 | | | EEMAC 4 - CONTACTS CLOSE ON LIQUID RISE |
| 9036 | GW1 | | | EEMAC 4 - CONTACTS CLOSE ON LIQUID RISE |
| 9036 | DR31 | | | EEMAC 7 & 9 - CONTACTS CLOSE ON LIQUID RISE |
| 9036 | GR1 | | | EEMAC 7 & 9 - CONTACTS CLOSE ON LIQUID RISE |

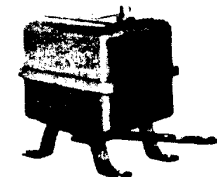

ACCESSORIES

9049 A6C 7" CENTER HOLE #304 S.S. FLOAT, 5' BRASS TUBING
 9049 A6CA 7" CENTER HOLE #304 S.S. FLOAT, 5' ALUM TUBING
 9049 A6CS 7" CENTER HOLE #316 S.S. FLOAT, 5' S.S. TUBING
 9049 A6 7" TAPPED AT TOP #304 S.S. FLOAT, 5' BRASS TUBING
 9049 A6A 7" TAPPED AT TOP #304 S.S. FLOAT, 5' ALUM TUBING
 9049 T1A 2 1/2' ALUM TUBING AND CONNECTOR
 9049 T1 2 1/2' BRASS TUBING AND CONNECTOR
 9049 T1S 2 1/2" S.S. TUBING AND CONNECTOR

LEVEL CONTROLS

MECHANICAL ALTERNATORS - TYPES B & C - CLOSED TANK - CLASS 9038

Reference Page #CP8-30 - Square D Mini Catalogue

**INDIVIDUALLY BOXED
PART NUMBER**

| CLASS | TYPE | CODE | FORM | CONNECTION/DESCRIPTION |
|-------|-------|------|------|---|
| 9038 | BG | 21 | | EEMAC 1 - FLANGED MOUNTED WITH BELLOWS SEAL |
| 9038 | BW | 21 | | EEMAC 4 - FLANGED MOUNTED WITH BELLOWS SEAL |
| 9038 | CG | 31 | | EEMAC 1 - 2 1/2" MPT CONN. FLOAT TO RIGHT |
| 9038 | CG | 32 | | EEMAC 4 - 2 1/2" MPT CONN. FLOAT TO LEFT |
| 9038 | CW | 31 | | EEMAC 4 - 2 1/2" MPT CONN. FLOAT TO RIGHT |
| 9049 | BF1 | | | #304 STAINLESS STEEL FLOAT |
| 9049 | BF2 | | | #316 STAINLESS STEEL FLOAT |
| 9049 | GBR11 | | | 11" BRASS ROD |
| 9049 | GBR3 | | | 3" BRASS ROD |
| 9049 | GBR5 | | | 5" BRASS ROD |
| 9049 | GSR3 | | | 3" STAINLESS ROD |
| 9049 | GSR5 | | | 5" STAINLESS ROD |

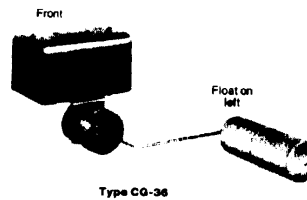
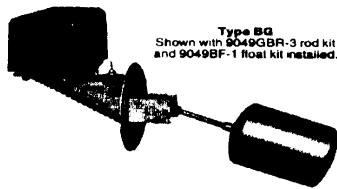

MECHANICAL ALTERNATORS - TYPES D & J - CLOSED TANK - CLASS 9038 ELECTRIC ALTERNATORS - TYPE X - CLASS 9039

Reference Page #CP8-31, CP8-32 & CP8-33 - Square D Mini Catalogue

**INDIVIDUALLY BOXED
PRICES UPON REQUEST**

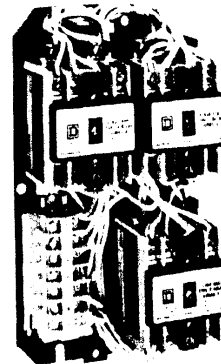
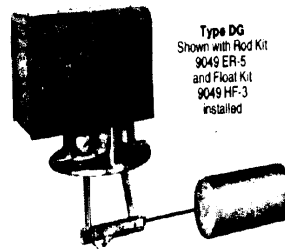
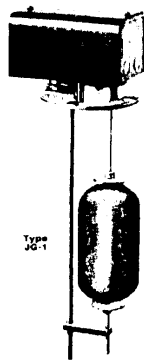

FLOATLESS LIQUID LEVEL CONTROL SYSTEMS

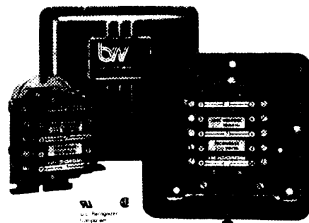

Provides automatic low level cut-off protection for submersible pumps and deep well turbines. Liquid level submersible pump control system consists of a standard enclosed type LH induction relay which operates from two type E1-S insulated electrodes suspended at desired levels. Properly installed, these components provide reliable automatic low level cut-off protection for submersible pumps and deep well turbines. Permits efficient operation at full capacity and eliminates danger of pumping air or sand.

TYPE LH RELAY - The HL Relay is rated 1 H.P. Single Phase, 110 or 220 volts and normally furnished in a Nema 1 Metal Enclosure. For control of a larger motor it can be used in conjunction with a magnetic starter that has overload protection.

TYPE DH RELAY - The DH Relay is a two way control system for pump up or pump down. Rated at H.P. Single Phase, 115 or 230 volts A

| PART NO. | MODEL # | LINE VOLTAGE | SECONDARY COIL VOLT | DESCRIPTION/OPERATION |
|----------|-------------------|--------------|---------------------|---------------------------------|
| LH-115 | 1500-C-L1-S8-NI-X | 110/120V | 360V AC | PUMP DOWN-SUBMERSIBLE |
| LH-230 | 1500-C-L2-S8-NI-X | 208/240V | 360V AC | PUMP DOWN-SUBMERSIBLE |
| RH-115 | 1500-D-L1-S8-NI-X | 110/120V | 360V AC | PUMP UP - OPEN SYSTEM |
| RH-230 | 1500-D-L2-S8-NI-X | 208/240V | 360V AC | PUMP UP - OPEN SYSTEM |
| DH-115 | 1500-G-L1-S8-NI-X | 110/120V | 360V AC | PUMP UP/DOWN-SUBMERSIBLE & OPEN |
| DH-230 | 1500-G-L2-S8-NI-X | 208/240V | 360V AC | PUMP UP/DOWN-SUBMERSIBLE & OPEN |

FLOAT SWITCHES

FLOAT SWITCHES - TYPES D, E - CLOSED TANK - CLASS 9037

Reference Page #CP8-26 - Square D Mini Catalogue

INDIVIDUALLY BOXED

PART NUMBER

| CLASS | TYPE | CONNECTION/DESCRIPTION |
|-------|------|---|
| 9037 | DG1 | EEMAC 1 - CONTACTS CLOSE ON LIQUID RISE |
| 9037 | DG2 | EEMAC 1 - CONTACTS CLOSE ON LIQUID RISE |
| 9037 | DW1 | EEMAC 4 - CONTACTS CLOSE ON LIQUID RISE |
| 9037 | DW2 | EEMAC 4 - CONTACTS CLOSE ON LIQUID RISE |
| 9037 | DR1 | EEMAC 7 & 9 - CONTACTS CLOSE ON LIQUID RISE |
| 9037 | DR2 | EEMAC 7 & 9 - CONTACTS CLOSE ON LIQUID RISE |
| 9037 | EG8 | EEMAC 1 - CONTACTS CLOSE ON LIQUID RISE |
| 9037 | EW8 | EEMAC 4 - CONTACTS CLOSE ON LIQUID RISE |
| 9037 | ER8 | EEMAC 7 & 9 - CONTACTS CLOSE ON LIQUID RISE |
| 9049 | EF1 | #304 S.S. FLOAT |
| 9049 | EF2 | #316 S.S. FLOAT |
| 9049 | ER3 | 3 1/4" STAINLESS STEEL ROD |
| 9049 | ER7 | 7 1/4" STAINLESS STEEL ROD |

D SERIES COMPLETE WITH FLOAT

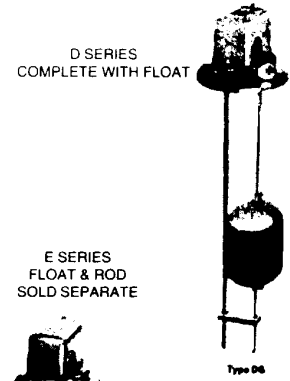

E SERIES FLOAT & ROD SOLD SEPARATE

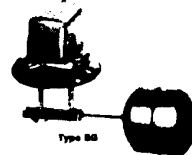

FLOAT SWITCHES - TYPES G - CLOSED TANK - CLASS 9037

Reference Page #CP8-27 - Square D Mini Catalogue

PART NUMBER - INDIVIDUALLY BOXED

| CLASS | TYPE | CONNECTION/DESCRIPTION |
|-------|------|--|
| 9037 | GG21 | EEMAC 1 - CONTACTS OPEN ON LIQUID RISE |
| 9037 | GG22 | EEMAC 1 - CONTACTS OPEN ON LIQUID RISE |
| 9037 | GW21 | EEMAC 4 - CONTACTS OPEN ON LIQUID RISE |
| 9037 | GR21 | EEMAC 7&9-CONTACTS OPEN ON LIQUID RISE |
| 9049 | GBR3 | 3" BRASS ROD |
| 9049 | GBR5 | 5" BRASS ROD |
| 9049 | GF1 | 4" DIAMETER BALL FLOAT #304 S.S. |
| 9049 | GF2 | #316 STAINLESS STEEL FLOAT |
| 9049 | GSR3 | 3" STAINLESS STEEL ROD |
| 9049 | GSR5 | 5" STAINLESS STEEL ROD |

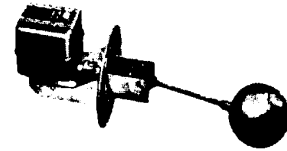

FLOAT SWITCHES - TYPES H - CLOSED TANK - CLASS 9037

Reference Page #CP8-28 - Square D Mini Catalogue

PART NUMBER - INDIVIDUALLY BOXED

| CLASS | TYPE | CODE | FORM | CONNECTION/DESCRIPTION |
|-------|------|------|------|---|
| 9037 | HG33 | | | EEMAC 1 - CONTACTS CLOSE ON LIQUID RISE |
| 9037 | HG33 | R | | EEMAC 1 - CONTACTS OPEN ON LIQUID RISE |
| 9037 | HG31 | | | EEMAC 1 - CONTACTS CLOSE ON LIQUID RISE |
| 9037 | HG31 | R | | EEMAC 1 - CONTACTS OPEN ON LIQUID RISE |
| 9037 | HG34 | | | EEMAC 1 - CONTACTS CLOSE ON LIQUID RISE |
| 9037 | HG37 | | | EEMAC 1 - CONTACTS CLOSE ON LIQUID RISE |
| 9037 | HR33 | | | EEMAC 7 & 9 - CONTACTS CLOSE ON LIQUID RISE |
| 9037 | HW33 | | | EEMAC 4 - CONTACTS CLOSE ON LIQUID RISE |
| 9049 | HF3 | | | #304 STAINLESS STEEL FLOAT |
| 9049 | HF4 | | | #316 STAINLESS STEEL FLOAT |

H SERIES COMPLETE WITH FLOAT



MECHANICAL ALTERNATORS - TYPES A - OPEN TANK - CLASS 9038

Reference Page #CP8-29 - Square D Mini Catalogue

PART NUMBER - INDIVIDUALLY BOXED

| CLASS | TYPE | CODE | FORM | CONNECTION/DESCRIPTION |
|-------|-------|------|------|---|
| 9038 | AG1 | | | EEMAC 1 - FLOAT OPERATED ALTERNATOR |
| 9038 | AW1 | | | EEMAC 4 - FLOAT OPERATED ALTERNATOR |
| 9038 | AG1N5 | | | EEMAC 1 - FLOAT OPERATED ALTERNATOR WITH HIGH WATER ALARM CIRCUIT |
| 9049 | UMS1 | | | UNIVERSAL MOUNTING BRACKET |
| 9049 | A15 | | | COMPENSATING SPRING |

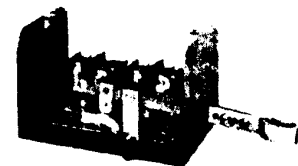

HOW TO SELECT THE CORRECT SUBMERSIBLE PUMPING EQUIPMENT

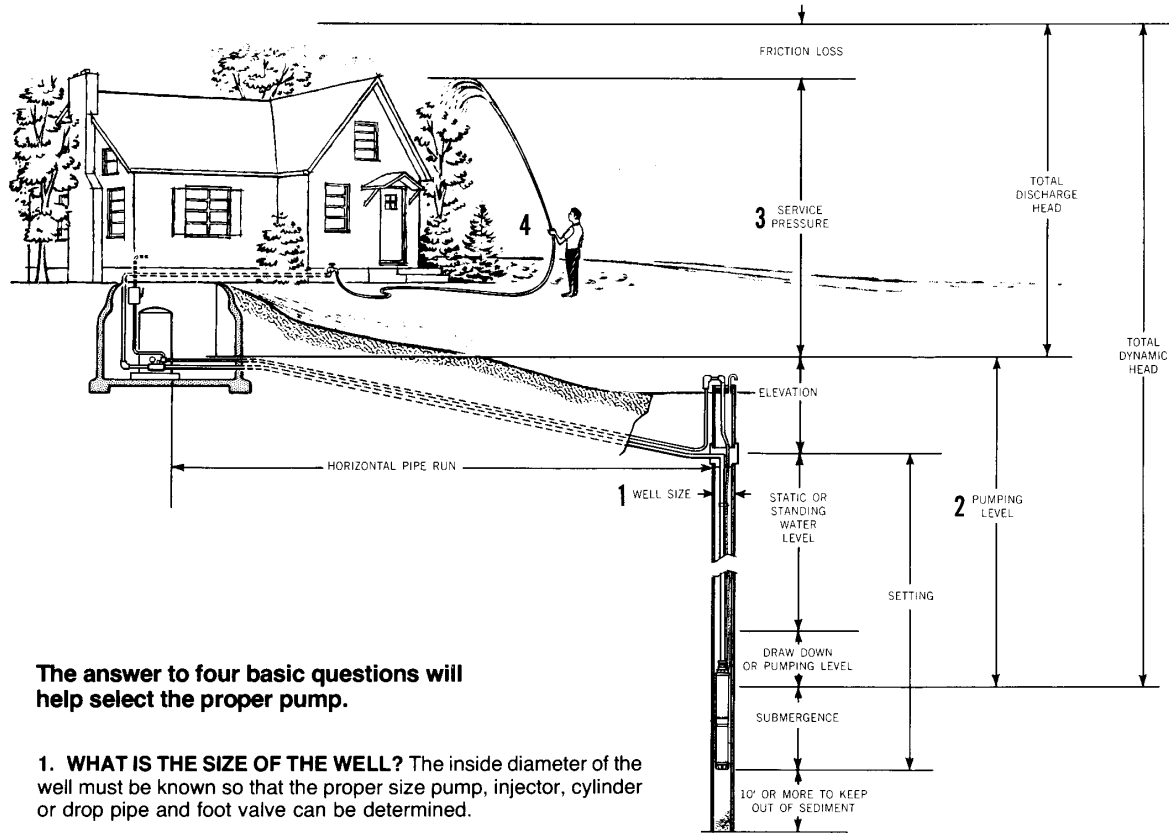

The answer to four basic questions will help select the proper pump.

1. WHAT IS THE SIZE OF THE WELL? The inside diameter of the well must be known so that the proper size pump, injector, cylinder or drop pipe and foot valve can be determined.

2. WHAT IS THE PUMPING LEVEL? The vertical distance in feet from the pump to the water level while the pump is operating. If the pump is installed away from the well and is on higher ground, this elevation must also be included. Most wells draw down while being pumped so this must not be confused with the standing water level.

3. WHAT SHOULD BE THE AVERAGE DISCHARGE PRESSURE? Usual average discharge pressure is 30 lbs.—halfway between the 20 lb. to 40 lb. switch setting of most water systems. When the tank is installed away from the pump at a higher level, or when house or yard fixtures are above the pump and tank, a greater pressure is needed and a larger pump must be used.

4. WHAT CAPACITY IS REQUIRED? The discharge capacity of the pump in gallons per hour that is needed for satisfactory service. The pump should have enough capacity so that it does not need to work more than the equivalent in intermittent service of 2 hours per day. See table of water requirements at right.

| AVERAGE WATER REQUIREMENTS FOR GENERAL SERVICE AROUND THE HOME AND FARM | |
|---|---------|
| Each person per day, for all purposes | 75 gal. |
| Each horse, dry cow or beef animal | 12 gal. |
| Each milking cow | 35 gal. |
| Each hog per day | 4 gal. |
| Each sheep per day | 2 gal. |
| Each 100 chickens per day | 4 gal. |

| AVERAGE AMOUNT OF WATER REQUIRED BY VARIOUS HOME AND YARD FIXTURES | |
|--|-------------------------|
| Drinking fountain, continuously flowing | 50 to 100 gal. per day |
| Each shower bath | Up to 30 gal. @ 3-5 GPM |
| To fill bathtub | 30 gal. |
| To flush toilet | 6 gal. |
| To fill lavatory | 2 gal. |
| To sprinkle 1/4" of water on each 1000 square feet of lawn | 160 gal. |
| Dish Washing Machine — per load | 7 gal. @ 4 GPM |
| Automatic washer — per load | Up to 50 gal. @ 4-6 GPM |
| Regeneration of Domestic Water Softener | 50-100 gal. |

| AVERAGE FLOW RATE REQUIREMENTS BY VARIOUS FIXTURES | |
|--|---------------|
| (g.p.m. equals gal. per minute; g.p.h. equals gal. per hour) | |
| Shower | 3-5 g.p.m. |
| Bathtub | 3-5 g.p.m. |
| Toilet | 3 g.p.m. |
| Lavatory | 3 g.p.m. |
| Kitchen sink | 2 to 3 g.p.m. |
| 1/2" hose and nozzle | 200 g.p.h. |
| 3/4" hose and nozzle | 300 g.p.h. |
| Lawn sprinkler | 120 g.p.h. |

BASIC SUBMERSIBLE PUMP INSTALLATION

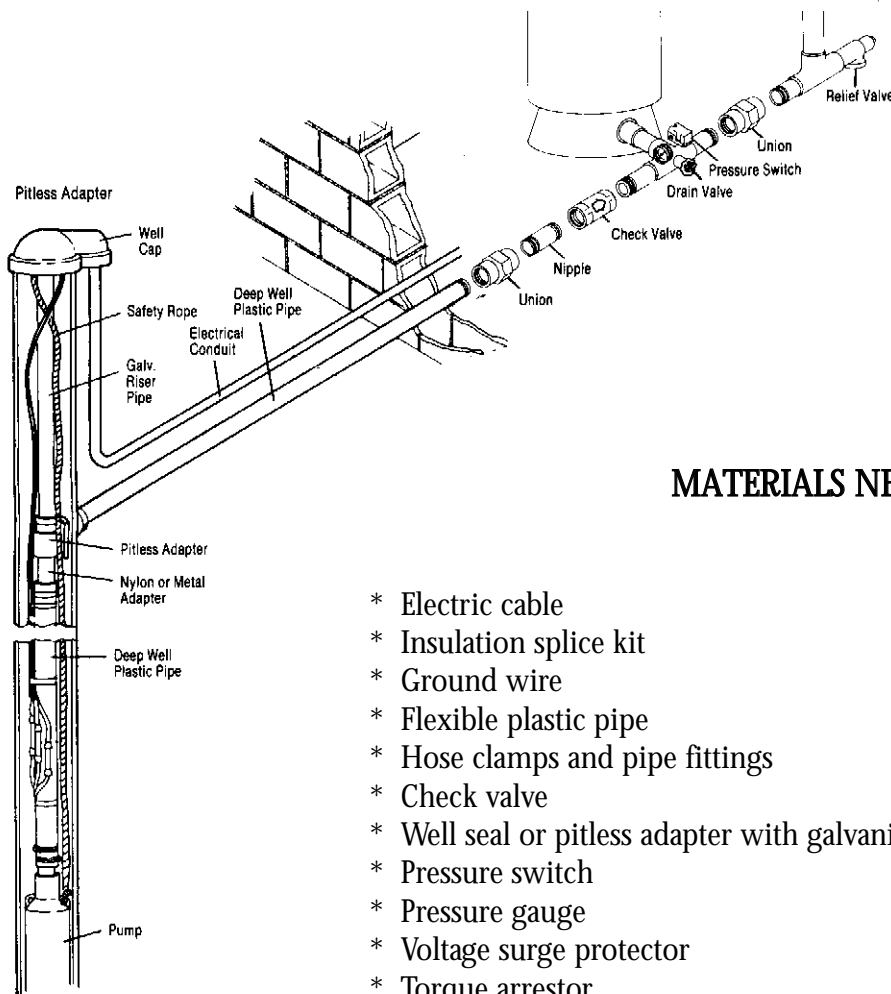

MATERIALS NEEDED

- * Electric cable
- * Insulation splice kit
- * Ground wire
- * Flexible plastic pipe
- * Hose clamps and pipe fittings
- * Check valve
- * Well seal or pitless adapter with galvanized riser pipe
- * Pressure switch
- * Pressure gauge
- * Voltage surge protector
- * Torque arrestor
- * Control box required on all 3-wire models

**CONTACT US FOR A
COMPLETE CATALOG ON
GRUNDFOS, REDJACKET OR
JACUZZI!**

GRUNDFOS PUMP SELECTION GUIDE

STANDARD SETTINGS

| MODEL | MIN. WELL SIZE | FLOW RANGE (GPM) | MAX WORKING HEAD (FEET) | MAX. WORKING HEAD (PSI) |
|-------|----------------|------------------|-------------------------|-------------------------|
| 5S | 4" | 1.2-7 | 870 | 377 |
| 7S | 4" | 3-10 | 680 | 2794 |
| 10S | 4" | 5-14 | 950 | 411 |
| 16S | 4" | 10-20 | 990 | 429 |
| 25S | 4" | 18-32 | 630 | 273 |
| 40S | 4" | 24-55 | 755 | 327 |
| 60S | 4" | 40-75 | 505 | 219 |
| 75S | 4" | 45-95 | 460 | 199 |



FEATURES

Smooth safety hook prevents frayed safety line.
 Built-in, jam free checkvalve designed for failsafe operation.
 Snapguard cable guard is designed for installation and removal. Hold tight and provides maximum protection to motor leads.
 Precision Form impellers are fabricated from stainless steel to provide long

pump life, maximum hydraulic efficiency and top pump performance.
 Exclusive prime inducer provides maximum pump protection from dry-run damage during low water situations.
 Pump inlet is totally screen to prevent damage from debris.
 All Grundfos submersibles are performance tested at the factory to verify specified performance.

DEEP SETTINGS

| MODEL | MIN. WELL SIZE | FLOW RANGE (GPM) | MAX. WORKING HEAD (FEET) | MAX. WORKING HEAD (PSI) |
|----------|----------------|------------------|--------------------------|-------------------------|
| 5S-DS | 4" | 1.2-7 | 1330 | 576 |
| 10S-DS | 4" & 5" | 5-14 | 1550 | 671 |
| 16S-DS | 6" | 10-20 | 1980 | 857 |
| 25S-DS | 6" | 18-32 | 1255 | 543 |
| 40S-DS | 6" | 24-55 | 1655 | 716 |
| 80S-DS | 6" & 8" | 48-110 | 1745 | 755 |
| 135S-DS | 6" & 8" | 75-200 | 1910 | 827 |
| 225S-DS | 8" | 150-290 | 1220 | 528 |
| 375S-DS | 8" | 230-500 | 1080 | 467 |
| 600S-DS | 10" | 350-500 | 590 | 255 |
| 1000S-DS | 10" | 600-1300 | 860 | 372 |



GRUNDFOS SUBMERSIBLE PUMPING SYSTEMS 4-INCH AND LARGER WELLS

| TYPE | HP | PH | VOLT | 2-WIRE | | 3-WIRE | | TYPE | HP | PH | VOLT | 2-WIRE | | 3-WIRE | |
|---------------|-------|----|------|----------|-------|----------|-------|---------------|-------|----|------|----------|-------|----------|-------|
| | | | | FIG. NO. | PRICE | FIG. NO. | PRICE | | | | | FIG. NO. | PRICE | FIG. NO. | PRICE |
| 5 GPM | | | | | | | | 7 GPM | | | | | | | |
| 5S03-9 | 1/3 | 1 | 115 | 39346 | | 39380 | | 7S03-8 | 1/3 | 1 | 115 | 39354 | | 39392 | |
| 5S03-9 | | | 230 | 39347 | | 39381 | | 7S03-8 | | | 230 | 39355 | | 39393 | |
| 5S05-13 | 1/2 | 1 | 115 | 39348 | | 39382 | | 7S05-11 | 1/2 | 1 | 115 | 39356 | | 39394 | |
| 5S05-13 | | | 230 | 39349 | | 39383 | | 7S05-11 | | | 230 | 39357 | | 39395 | |
| 5S07-18 | 3/4 | 1 | 230 | 39350 | | 39384 | | 7S07-15 | 3/4 | 1 | 230 | 39358 | | 39396 | |
| 5S10-22 | 1 | 1 | 230 | 39351 | | 39385 | | 7S10-19 | 1 | 1 | 230 | 39359 | | 39397 | |
| 5S15-26 | 1 1/2 | 1 | 230 | 39352 | | 39386 | | 7S15-26 | 1 1/2 | 1 | 230 | 39360 | | 39398 | |
| 5S15-26 | | 3 | 230 | | | 39387 | | 7S15-26 | | 3 | 230 | | | 39399 | |
| 5S15-26 | | 3 | 460 | | | 39388 | | 7S15-26 | | 3 | 460 | | | 39400 | |
| 5S15-31 | 1 1/2 | 1 | 230 | 39353 | | 39389 | | 16 GPM | | | | | | | |
| 5S15-31 | | 3 | 230 | | | 39390 | | 16S05-5 | 1/2 | 1 | 115 | 39368 | | 39416 | |
| 5S15-31 | | 3 | 460 | | | 39391 | | 16S05-5 | | | 230 | 39369 | | 39417 | |
| 10 GPM | | | | | | | | 16S07-8 | 3/4 | 1 | 230 | 39370 | | 39418 | |
| 10S03-6 | 1/3 | 1 | 115 | 39361 | | 39401 | | 16S10-10 | 1 | 1 | 230 | 39371 | | 39419 | |
| 10S03-6 | | | 230 | 39362 | | 39402 | | 16S15-14 | 1 1/2 | 1 | 230 | 39372 | | 39420 | |
| 10S05-9 | 1/2 | 1 | 115 | 39363 | | 39403 | | 16S15-14 | | 3 | 230 | | | 39421 | |
| 10S05-9 | | | 230 | 49834 | | 49223 | | 16S15-14 | | 3 | 460 | | | 39422 | |
| 10S07-12 | 3/4 | 1 | 230 | 39365 | | 39405 | | 16S20-18 | 2 | 1 | 230 | | | 39423 | |
| 10S10-15 | 1 | 1 | 230 | 39366 | | 39406 | | 16S20-18 | | 3 | 230 | | | 39424 | |
| 10S15-21 | 1 1/2 | 1 | 230 | 39367 | | 39407 | | 16S20-18 | | 3 | 460 | | | 39425 | |
| 10S15-21 | | 3 | 230 | | | 39408 | | 16S30-24 | 3 | 1 | 230 | | | 39426 | |
| 10S15-21 | | 3 | 460 | | | 39409 | | 16S30-24 | | 3 | 230 | | | 39427 | |
| 10S20-27 | 2 | 1 | 230 | | | 39410 | | 16S30-24 | | 3 | 460 | | | 39428 | |
| 10S20-27 | | 3 | 230 | | | 39411 | | 16S50-38 | 5 | 1 | 230 | | | 39429 | |
| 10S20-27 | | 3 | 460 | | | 39412 | | 16S50-38 | | 3 | 230 | | | 39430 | |
| 10S30-34 | 3 | 1 | 230 | | | 39413 | | 16S50-38 | | 3 | 460 | | | 39431 | |
| 10S30-34 | | 3 | 230 | | | 39414 | | 40 GPM | | | | | | | |
| 10S30-34 | | 3 | 460 | | | 39415 | | 40S10-3 | 1 | 1 | 230 | 27143 | | 27144 | |
| 25 GPM | | | | | | | | 40S15-5 | 1 1/2 | 1 | 230 | 27145 | | 27146 | |
| 25S05-3 | 1/2 | 1 | 115 | 39373 | | 39432 | | 40S15-5 | | 3 | 230 | | | 27147 | |
| 25S05-3 | | | 230 | 39374 | | 39433 | | 40S15-5 | | 3 | 460 | | | 27148 | |
| 25S07-5 | 3/4 | 1 | 230 | 39375 | | 39434 | | 40S20-7 | 2 | 1 | 230 | | | 27149 | |
| 25S10-7 | 1 | 1 | 230 | 39376 | | 39436 | | 40S20-7 | | 3 | 230 | | | 27150 | |
| 25S15-9 | 1 1/2 | 1 | 230 | 39377 | | 39436 | | 40S20-7 | | 3 | 460 | | | 27151 | |
| 25S15-9 | | 3 | 230 | | | 39437 | | 40S30-9 | 3 | 1 | 230 | | | 27153 | |
| 25S15-9 | | 3 | 460 | | | 39438 | | 40S30-9 | | 3 | 230 | | | 27154 | |
| 25S20-11 | 2 | 1 | 230 | | | 39439 | | 40S30-9 | | 3 | 460 | | | 27155 | |
| 25S20-11 | | 3 | 230 | | | 39440 | | 40S50-12 | 5 | 1 | 230 | | | 27156 | |
| 25S20-11 | | 3 | 460 | | | 39441 | | 40S50-12 | | 3 | 230 | | | 27157 | |
| 25S30-15 | 3 | 1 | 230 | | | 39442 | | 40S50-12 | | 3 | 460 | | | 27158 | |
| 25S30-15 | | 3 | 230 | | | 39443 | | 40S50-15 | 5 | 1 | 230 | | | 27159 | |
| 25S30-15 | | 3 | 460 | | | 39444 | | 40S50-15 | | 3 | 230 | | | 27160 | |
| 25S50-26 | 5 | 1 | 230 | | | 39445 | | 40S50-15 | | 3 | 460 | | | 27161 | |
| 25S50-26 | | 3 | 230 | | | 39446 | | 40S75-21 | 7 1/2 | 3 | 230 | | | 27162 | |
| 25S50-26 | | 3 | 460 | | | 39447 | | 40S75-21 | | 3 | 460 | | | 27163 | |
| | | | | | | | | 40275-25 | 7 1/2 | 3 | 230 | | | 27164 | |
| | | | | | | | | 40275-25 | | 3 | 460 | | | 27165 | |
| | | | | | | | | 40S100-30 | 10 | 3 | 460 | | | 27167 | |

GRUNDFOS SUBMERSIBLE PUMPING SYSTEMS 4-INCH AND LARGER WELLS,

| TYPE | HP | PH | VOLT | 2-WIRE | | 3-WIRE | | TYPE | HP | PH | VOLT | 2-WIRE | | 3-WIRE | |
|---------------|-------|----|------|----------|-------|----------|-------|---------------|-------|----|------|----------|-------|----------|-------|
| | | | | FIG. NO. | PRICE | FIG. NO. | PRICE | | | | | FIG. NO. | PRICE | FIG. NO. | PRICE |
| 60 GPM | | | | | | | | 75 GPM | | | | | | | |
| 60S20-4 | 2 | 1 | 230 | | | | 39470 | 75S20-3 | 2 | 1 | 230 | | | | 39485 |
| 60S20-4 | | 3 | 230 | | | | 39471 | 75S20-3 | | 3 | 230 | | | | 39486 |
| 60S20-4 | | 3 | 460 | | | | 39472 | 75S20-3 | | 3 | 460 | | | | 39487 |
| 60S30-5 | 3 | 1 | 230 | | | | 39473 | 75S30-5 | 3 | 1 | 230 | | | | 39488 |
| 60S30-5 | | 3 | 230 | | | | 39474 | 75S30-5 | | 3 | 230 | | | | 39489 |
| 60S30-5 | | 3 | 460 | | | | 39475 | 75S30-5 | | 3 | 460 | | | | 39490 |
| 60S50-7 | 5 | 1 | 230 | | | | 39476 | 75S50-8 | 5 | 1 | 230 | | | | 39491 |
| 60S50-7 | | 3 | 230 | | | | 39477 | 75S50-8 | | 3 | 230 | | | | 39492 |
| 60S50-7 | | 3 | 460 | | | | 39478 | 75S50-8 | | 3 | 460 | | | | 39493 |
| 60S50-9 | 5 | 1 | 230 | | | | 39479 | 75S75-12 | 7 1/2 | 3 | 230 | | | | 39494 |
| 60S50-9 | | 3 | 230 | | | | 39480 | 75S75-12 | | 3 | 460 | | | | 39495 |
| 60S50-9 | | 3 | 460 | | | | 39481 | 75S100-16 | 10 | 3 | 460 | | | | 39496 |
| 60S75-13 | 7 1/2 | 3 | 230 | | | | 39482 | | | | | | | | |
| 60S75-13 | | 3 | 460 | | | | 39483 | | | | | | | | |
| 60S100-18 | 10 | 3 | 460 | | | | 39484 | | | | | | | | |

Redi-Flo...the industry's choice for environmental applications



Environmental Engineers Specify the Pump they've Relied on for Years...GRUNDFOS

Typical Applications Include Well Purging and Water Table Depression

**FOR MORE INFORMATION
VISIT OUR
ENVIRONMENTAL SECTION!**

3" JET SUB

| FIG. NO. | MDL | MTR HP | SF | AMPS | PRICE |
|----------|---------|--------|------|------|-------|
| 47837 | JS05-03 | 1/3 | 1.75 | 7 | |
| 47839 | JS05-05 | 1/2 | 1.6 | 9 | |
| 47840 | JS05-07 | 3/4 | 1.5 | 11 | |
| 47841 | JS07-03 | 1/3 | 1.75 | 7 | |
| 47842 | JS07-05 | 1/2 | 1.6 | 9 | |
| 47843 | JS07-07 | 3/4 | 1.5 | 11 | |
| 47844 | JS10-03 | 1/3 | 1.75 | 7 | |
| 47845 | JS10-05 | 1/2 | 1.6 | 9 | |
| 47846 | JS10-07 | 3/4 | 1.5 | 11 | |
| 47847 | JS16-05 | 1/2 | 1.6 | 9 | |
| 47848 | JS16-07 | 3/4 | 1.5 | 11 | |

* Measurement taken with RMS instrument

Weights and Dimensions

| MODEL | LENGTH | WIDTH | APPROX. SHIP WT. |
|-------|---------|----------|------------------|
| ALL | 17 3/8" | 2 13/16" | 11 lbs. |

JetSub Pump Nomenclature

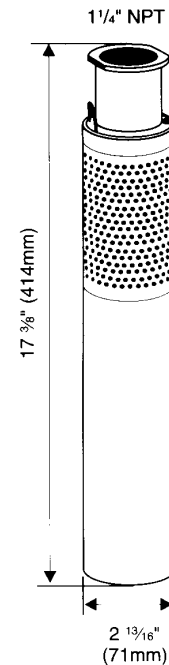
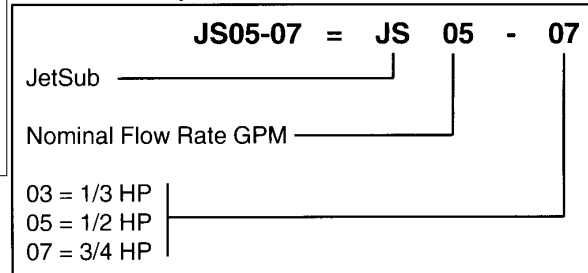

**CALL
DUFF FIRST
FOR
ALL
YOUR
PUMP
NEEDS
610-275-4453**

3" SUBMERSIBLE PUMP

Submersible Pumps vs. Jet Pumps

Submersible and jet pumps are both used in domestic groundwater systems. When high flow rates and pressure settings are required at high operating efficiencies, submersible pumps are generally preferred. Submersible pumps have the advantage of performing well both in shallow well applications as well as at depths to 2,000 feet. An extensive range of submersible pump models is also available allowing a precise match to exact system requirements.

Convertible jet pumps are sometimes an economical alternative to submersibles, especially in shallow well installations of 25 feet or less. The pumps are less expensive, installation is simplified, and they are easily converted for deep well installations down to 100 feet (Figure 8-H).

In "weak" well applications where the pump lowers the water level in the well faster than the well can replenish itself, a deep well jet pump with a tail pipe is particularly effective when flow requirements are relatively small. By adding 35 feet of tail pipe below the jet assembly with the foot valve attached to the bottom, it will not be possible to pull the well down and allow air to enter the system. Pump delivery remains at 100% of the rated capacity down to the level of the jet assembly. If the water level falls below that point, flow decreases in proportion to the drawdown as shown in Figure 8-I. When pump delivery equals well inflow, the water level remains constant until the pump shuts off. At 33.9 feet of drawdown the pump will no longer deliver water but the foot valve will remain fully submerged.

GRUNDFOS JETSUB SELECTION CHART

JetSub Selection Charts (Ratings are in GALLONS PER HOUR—GPH)

SELECTION CHARTS

PUMP OUTLET

(Ratings are in GALLONS PER HOUR-GPH)

1 1/4"

| DEPTH TO PUMPING WATER LEVEL (LIFT) IN FEET | | | | | | | | | | | | | |
|---|-----|------|------|------|-----|-----|-----|-----|-----|-----|-----|-----|-----|
| PUMP MODEL | PSI | 20 | 40 | 60 | 80 | 100 | 120 | 140 | 160 | 180 | 200 | 220 | 240 |
| JS05-03 | 30 | 480 | 432 | 384 | 330 | 284 | 198 | 120 | | | | | |
| | 40 | 480 | 372 | 312 | 246 | 168 | 90 | | | | | | |
| | 50 | 354 | 300 | 240 | 156 | 90 | | | | | | | |
| | 60 | 282 | 22 | 156 | 90 | | | | | | | | |
| JS05-05 | 30 | | 480 | 438 | 396 | 360 | 324 | 276 | 234 | 198 | 156 | 102 | |
| | 40 | 474 | 420 | 384 | 342 | 288 | 258 | 222 | 180 | 138 | 96 | 66 | |
| | 50 | 408 | 384 | 324 | 288 | 258 | 210 | 174 | 138 | 96 | 54 | | |
| | 60 | 384 | 336 | 288 | 258 | 210 | 174 | 156 | 96 | 48 | | | |
| JS05-07 | 30 | | | | | | 456 | 402 | 372 | 336 | 300 | 276 | 234 |
| | 40 | | | | | 432 | 396 | 354 | 324 | 282 | 252 | 228 | 204 |
| | 50 | | | 480 | 432 | 390 | 354 | 324 | 282 | 252 | 222 | 210 | 174 |
| | 60 | | 474 | 426 | 384 | 366 | 324 | 282 | 252 | 222 | 204 | 168 | 150 |
| JS07-03 | 30 | | | 438 | 354 | 240 | | | | | | | |
| | 40 | | 420 | 324 | 198 | | | | | | | | |
| | 50 | | 300 | 180 | | | | | | | | | |
| | 60 | 300 | 168 | | | | | | | | | | |
| JS07-05 | 30 | | | | 456 | 432 | 378 | 336 | 282 | 222 | 144 | | |
| | 40 | | | 450 | 408 | 372 | 330 | 270 | 210 | 102 | | | |
| | 50 | | 438 | 402 | 372 | 312 | 258 | 210 | 102 | | | | |
| | 60 | 444 | 408 | 372 | 312 | 258 | 210 | | | | | | |
| JS07-07 | 30 | | | | | | 462 | 438 | 402 | 378 | 342 | 306 | |
| | 40 | | | | | | 462 | 438 | 396 | 366 | 330 | 306 | 258 |
| | 50 | | | | | 456 | 432 | 396 | 360 | 324 | 282 | 252 | 210 |
| | 60 | | | | 450 | 432 | 396 | 366 | 330 | 282 | 252 | 210 | 156 |
| JS10-03 | 30 | 678 | 582 | 438 | | | | | | | | | |
| | 40 | 558 | 420 | | | | | | | | | | |
| | 50 | 360 | | | | | | | | | | | |
| | 60 | | | | | | | | | | | | |
| JS10-05 | 30 | | | 666 | 606 | 540 | 414 | 336 | | | | | |
| | 40 | 714 | 660 | 588 | 516 | 420 | 306 | | | | | | |
| | 50 | 648 | 582 | 516 | 414 | 276 | | | | | | | |
| | 60 | 582 | 510 | 414 | 276 | | | | | | | | |
| JS10-07 | 30 | | | | | 720 | 642 | 594 | 534 | 462 | 414 | 312 | |
| | 40 | | | | 696 | 642 | 570 | 522 | 456 | 396 | 306 | 210 | |
| | 50 | | | 690 | 636 | 582 | 516 | 450 | 360 | 288 | 186 | | |
| | 60 | | 684 | 624 | 576 | 522 | 438 | 366 | 294 | 180 | | | |
| JS16-05 | 30 | 1056 | 936 | 780 | 648 | 450 | | | | | | | |
| | 40 | 894 | 768 | 606 | 372 | | | | | | | | |
| | 50 | 726 | 546 | 342 | | | | | | | | | |
| | 60 | 546 | 318 | | | | | | | | | | |
| JS16-07 | 30 | 1158 | 1086 | 1014 | 912 | 810 | 714 | 588 | 456 | 300 | | | |
| | 40 | 1074 | 990 | 900 | 804 | 672 | 558 | 420 | 252 | | | | |
| | 50 | 966 | 858 | 792 | 660 | 540 | 384 | 210 | | | | | |
| | 60 | 858 | 768 | 648 | 534 | 378 | | | | | | | |

JACUZZI SUBMERSIBLE PUMPS

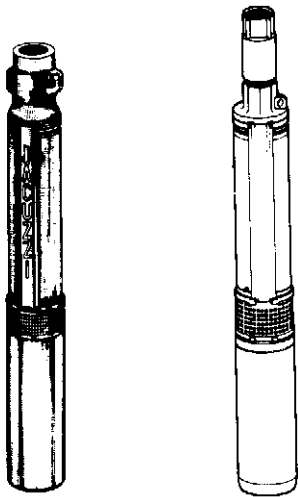

Thermoplastic

Bronze

SandHandler™ 4" Submersible Pumps

- Available in bronze and stainless steel or thermoplastic and stainless steel.
- Ceramic shaft sleeve and rubber discharge bearing reduces sand wear.
- Thermoplastic impellers and stages for maximum efficiency.
- Bronze model includes separate external check valve.
- Thermoplastic model includes built-in check valve.
- Available in 5 to 25 gpm models.



JACUZZI SANDHANDLER 5 GPM

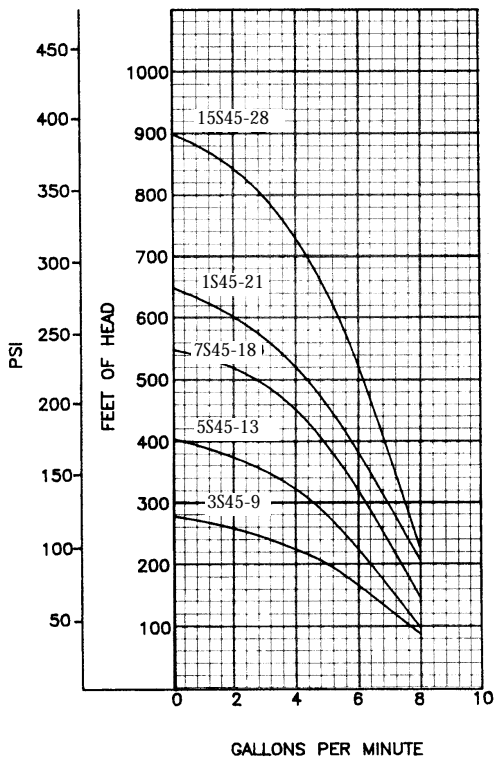

JACUZZI SANDHANDLER 7 GPM

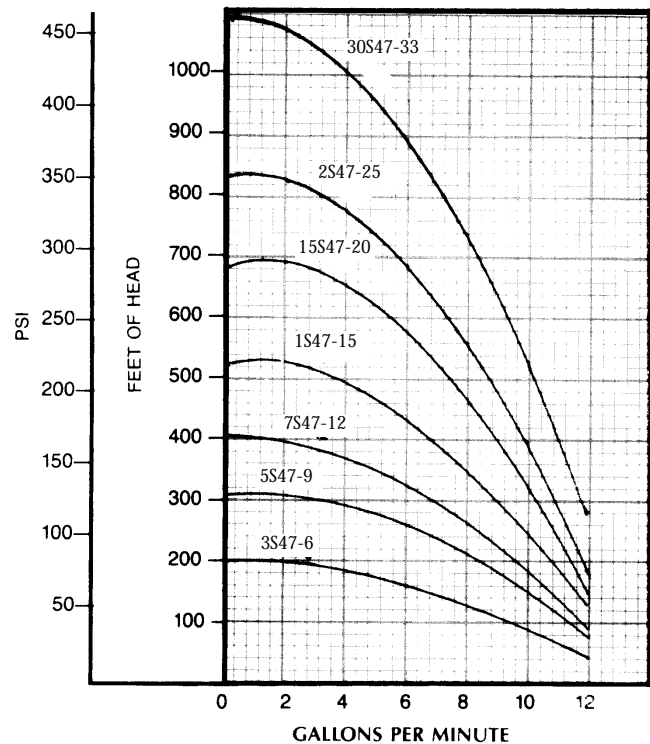

JACUZZI SANDHANDLER 10 GPM

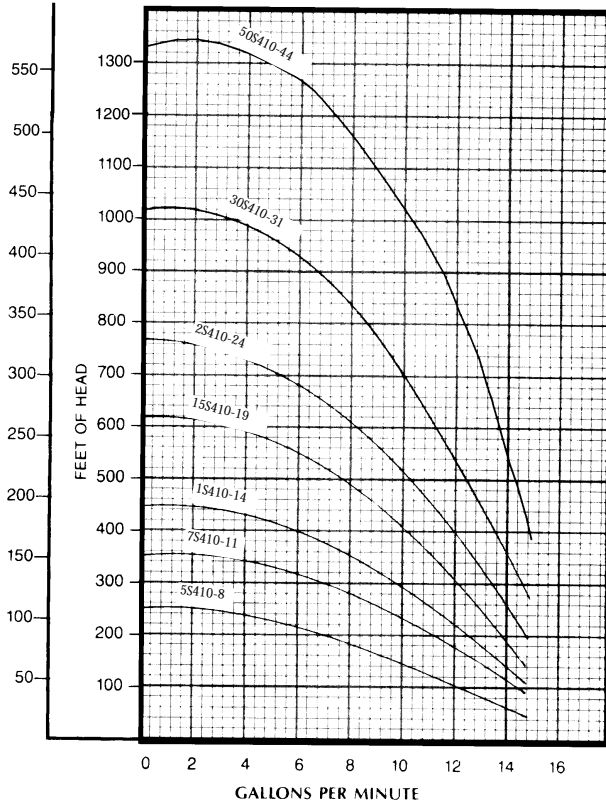

JACUZZI SANDHANDLER 18 GPM

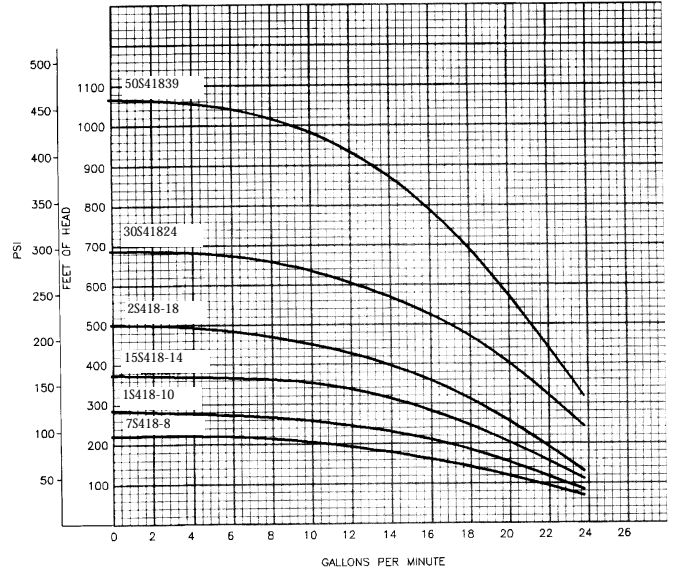

JACUZZI SANDHANDLER 25 GPM

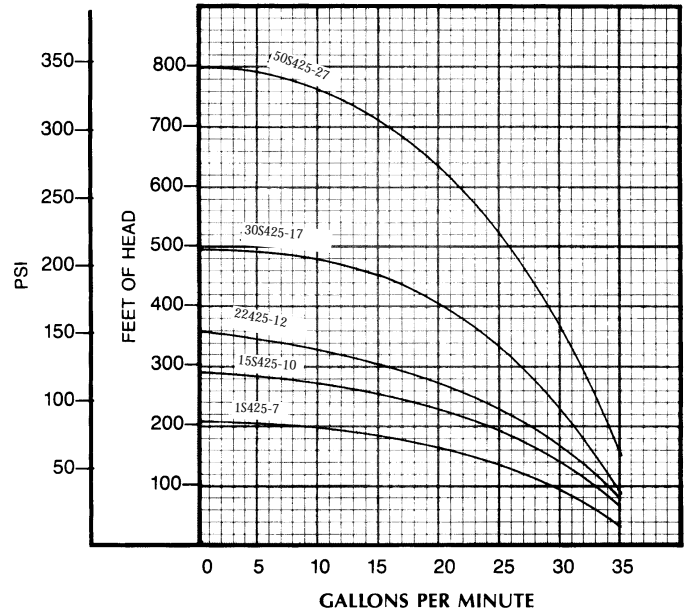

HIGH CAPACITY PUMPS

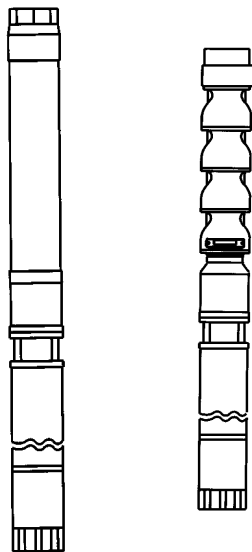

4" FEATURES

- *Cast iron discharge head and motor bracket
- *3 performance ranges - 45, 60 & 90 GPM
- *High flow impellers and stages are glass filled noryl for maximum efficiency
- *Ceramic shaft sleeve and rubber discharge bearing reduces sand wear
- *Floating eye and hub seals for improved performance and efficiency.
- *Stainless steel hex pump shaft, shell and shaft coupling.
- *High capacity upthrust assembly for protection during start-up and operation
- *Powered by Franklin's corrosion resistant 4" submersible motors 2" discharge

For additional information call: 610-275-4453 or Fax: 610-279-6299
Please call for current prices.

6" FEATURES

Designed for farm, irrigation, industry, municipal and commercial use. The 6" submersible turbine is available in 6 different performances from 90 GPM to 500 GPM ranging from 7 1/2 to 60 HP.

HURRICANE™

SUBMERSIBLE PUMP BY JACUZZI



If you are a home owner needing a submersible pump, there are several things you expect:

- Performance that delivers the water you want at the pressure you need.
- A quality, non-corrosive, durable product.
- Environmentally conscious, lead-free construction.
- Economical pricing.

With the Jacuzzi Hurricane submersible pump that's what you get!



POWERED BY
Franklin Electric

The **HURRICANE™** Submersible Pump by **JACUZZI**

HYDROSERVANT I REGULATING VALVES

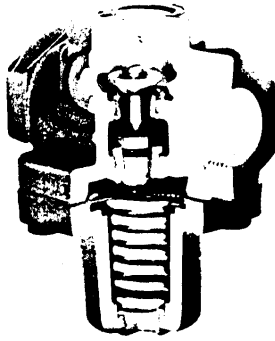

Nothing burns out a pump motor quicker than heat from frequent starts and stops. Momentary power required to start a motor generates high heat that can build up and cause deterioration of motor windings.

Red Jacket's HydroServant I regulating valves eliminates this rapid-cycling condition. It allows the pump to run under water demand conditions as slow as a half gallon per minute. The HydroServant I creates a delay between starts, even when faucets are quickly opened and closed. That's the reason behind its popularity as it minimizes starting and stopping of the pump, to assure even water pressure. HydroServant I assures far less cycling during a typical day than other regulating devices, but will allow the pump to run as long as there is a demand for water. The pump cuts off when pressure reaches a predetermined level, keeping constant pressure in the system when there is no water demand.

FOR CAPACITIES UP TO 20 GPM

- Provides constant water pressure
- Ends pressure variations
- Eliminates rapid-cycling
- Compact, space saving design
- Economical tank package alternative

ALSO IDEAL FOR THE FOLLOWING APPLICATIONS

- Booster pump on low demand and volume water systems
- Restricted storage areas such as trailer or mobile home water systems
- Condominium water systems
- Summer resort homes

| FIG. NO. | PRICE |
|----------|-------|
| 10945 | |

For additional information call: 610-275-4453 or Fax: 610-279-6299
Please call for current prices.

HYDROSERVANT II REGULATING VALVES

FOR CAPACITIES FROM 30 TO 300 GPM

- Regulates pressure in larger capacity systems
- Maintains constant pressure output
- Cost less than pressure tank systems of equivalent size or larger
- Eliminates rapid-cycling

ALSO IDEAL FOR THE FOLLOWING APPLICATIONS

- Sprinkler irrigation installations
- Small community water systems
- Industrial/Commercial plant water systems
- Cooling tower installations



The HydroServant II features a pressurized air chamber with a sensitive pressure switch which activates the pump to maintain both pressure and volume. The pump operates as long as there is a demand on the system, even at levels as low as 30 GPM, and shuts off only when demand is withdrawn. The HydroServant II drastically reduces rapid-cycling, which is a major cause of motor winding burn-out. Conventional hydro-pneumatic tank systems in high-capacity applications can be replaced by a HydroServant II installation.



| FIG. NO. | PRICE |
|----------|-------|
| 61440 | |



GRIZZLY BY RED JACKET

The Red Jacket 2-wire and 3-wire GRIZZLY is the most advanced pump on the market today. At Red Jacket, we believe the best way to build top quality products is to manufacture them ourselves. Red Jacket is one of the few remaining American companies that designs and manufactures its own motors. This ability allows us to perfectly match our pumps and motors to give maximum performance.

Our 208/230 volt motor is the only standard dual rated motor in the industry. When voltage supplies are not a consistent 230 volts, as in some rural applications, our motor will continue to operate efficiently, unlike the motors of our competitors.

The continuous duty capacitor on our 2-wire motors provides quiet operation and lower operating costs.

All Red Jacket submersible pumps are American made at our modern manufacturing facility in Davenport, Iowa.

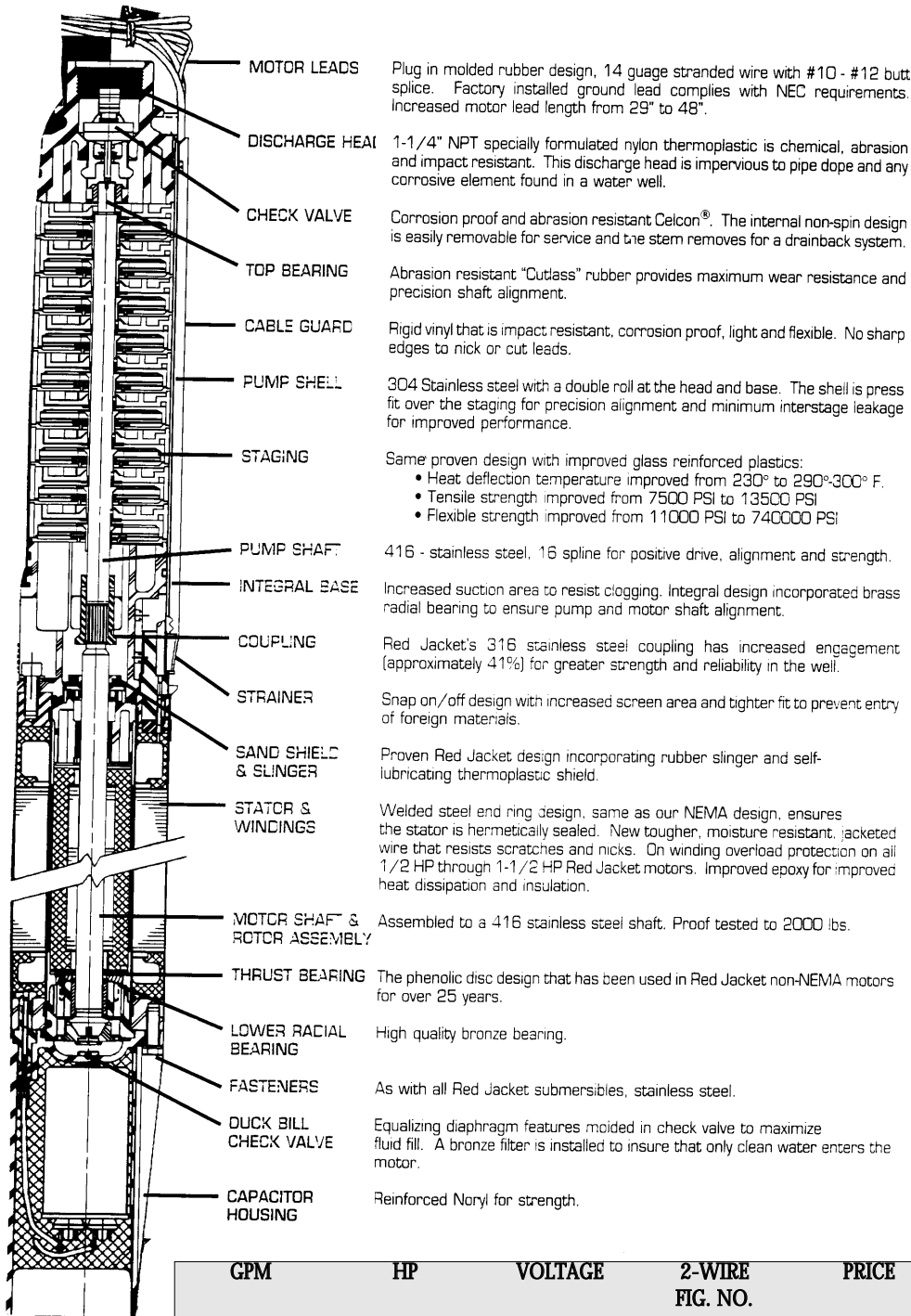

| GPM | HP | VOLTAGE | 2-WIRE FIG. NO. | PRICE | 3-WIRE FIG. NO. | PRICE |
|--------|-------|---------|--------------------|-------|--------------------|-------|
| 6 GPM | 1/2 | 230 | 73018 | | 73039 | |
| 6 GPM | 3/4 | 230 | 73019 | | 73040 | |
| 6 GPM | 1 | 230 | 73020 | | 73035 | |
| 8 GPM | 1/2 | 230 | 73022 | | 73042 | |
| 8 GPM | 3/4 | 230 | 73023 | | 73043 | |
| 8 GPM | 1 | 230 | 73024 | | 73044 | |
| 12 GPM | 1/2 | 115 | 73026 | | 73046 | |
| 12 GPM | 1/2 | 230 | 73027 | | 73048 | |
| 12 GPM | 3/4 | 230 | 73028 | | 73049 | |
| 12 GPM | 1 | 230 | 73029 | | 73050 | |
| 20 GPM | 1 | 230 | 72023 | | 73056 | |
| 20 GPM | 1 1/2 | 230 | 72024 | | 73058 | |
| 25 GPM | 1 | 230 | 73036 | | 73059 | |
| 25 GPM | 1 1/2 | 230 | 73037 | | 73060 | |

RED JACKET GRIZZLY SUBMERSIBLE PUMPS

Performance Curves — 12G Series

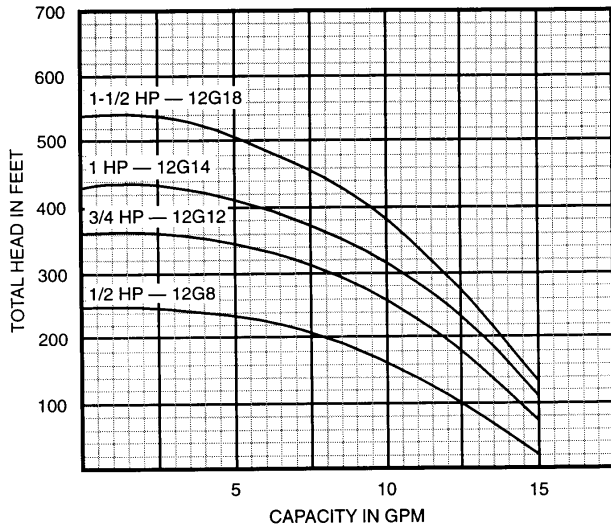

Performance Curves — 12G Series

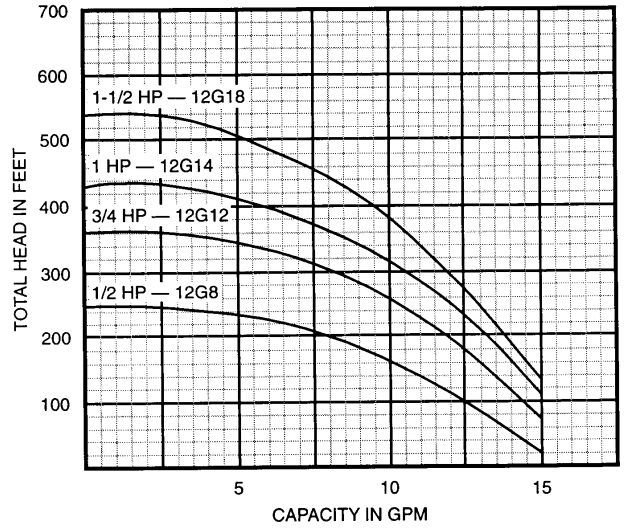

Performance Curves — 20G Series

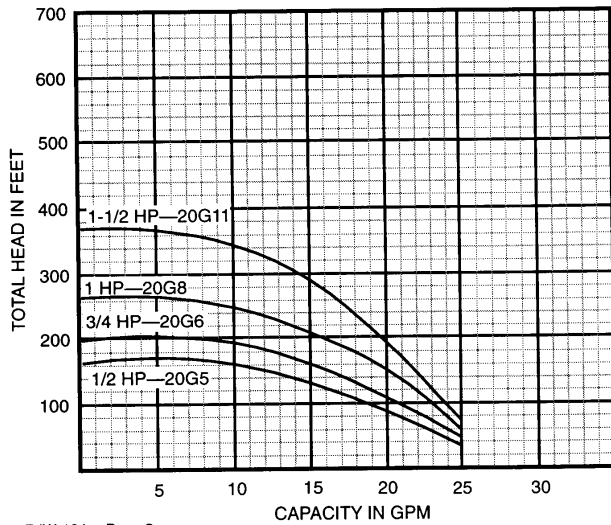

RJW-124— Page 2

Performance Curves — 20G Series

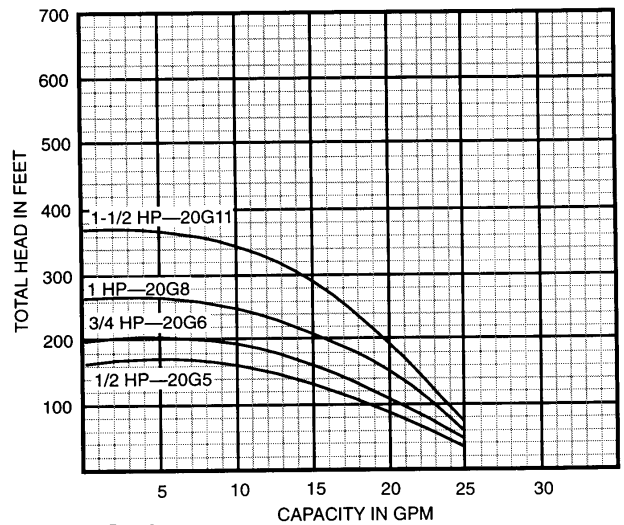

RJW-124— Page 2

RED JACKET CONTROL BOXES

| HP | VOLTAGE | FIG. NO. | PRICE |
|-------|---------|----------|-------|
| 1/2 | 115 | 9906 | |
| 1/2 | 230 | 9902 | |
| 3/4 | 230 | 9911 | |
| 1 | 230 | 9916 | |
| 1 1/2 | 230 | 9916 | |
| 2 | 230 | 9947 | |
| 3 | 230 | 9953 | |
| 5 | 230 | 9961 | |

Performance Curves — 25G Series

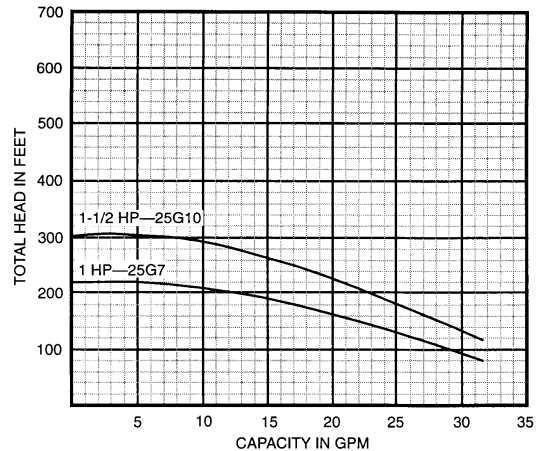

For additional information call: 610-275-4453 or Fax: 610-279-6299
Please call for current prices.

HOW A JET PUMP WORKS

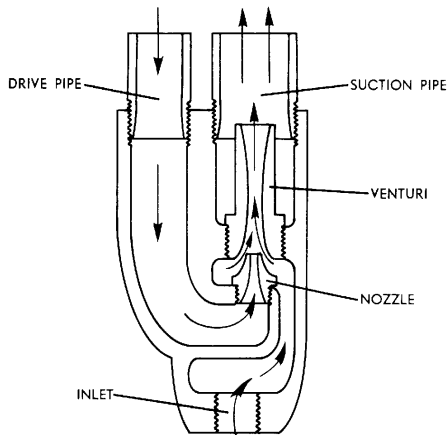

A jet pump pumps water with water. In deep well jet pumps a small amount of the water delivered by the pump is returned through the pressure pipe to the nozzle of the injector. The nozzle converts this high pressure to velocity. In the Venturi, this velocity is reduced and a partial vacuum is created, causing water in the well to enter the injector. This additional water is carried along with the water circulated by the pump—moved up the suction pipe to the impeller. This extra water picked up by the jet in the well is discharged by the pump with a portion of it recirculating through the injector to enable the jet to function. In the shallow well jet, the operation of the injector is the same except that the injector is located at the entrance to the impeller rather than down the well. In a shallow well jet pump, passages in the pump case casting serve the functions of the pressure and suction pipes used with deep well jet pumps.

SHALLOW WELL

Where the vertical distance between the pump and the water level in the well is less than 25 feet, the injector is incorporated in the pump. Only a suction pipe with a foot valve is lowered into the well.

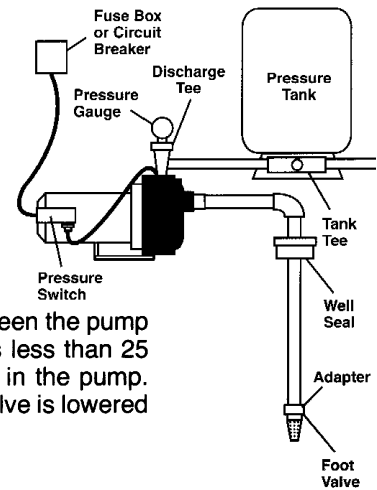

DEEP WELL

When the vertical distance between the pump and the water level in the well is more than 25 feet, the injector is placed below the water level in the well.

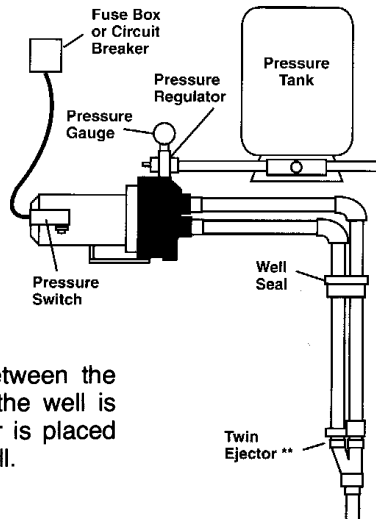

GRUNDFOS®

Leaders in Pump Technology



JACUZZI®

REDJACKET®

**CALL DUFF
FIRST
FOR ALL
YOUR PUMP
NEEDS!**

GRUNDFOS JET PUMPS

CONVERTIBLE JET

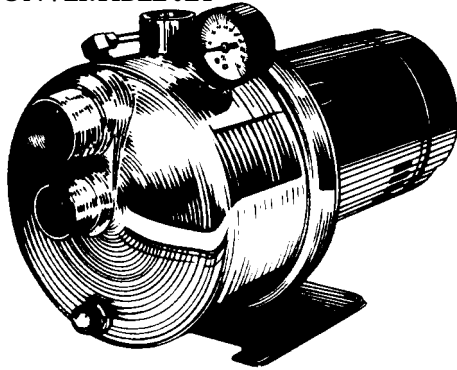

Materials of Construction

| DESCRIPTION | MATERIAL |
|--------------------|-------------------------|
| Motor Stool | E-Coated Aluminum |
| Shaft Seal | Carbon/Ceramic/EPDM |
| O-Rings & Gaskets | EPDM |
| Base Plate | AISI 304 SS |
| Pump Housing (Cap) | AISI 304 SS |
| Impeller | AISI 304/316 SS |
| Tubing | Polyethylene |
| Seal Plate | AISI 304 SS |
| Ejector/Guide Vane | AISI 304 SS/EPDM/Noryl® |

NOTES: EPDM - Ethylene Propylene Rubber
Noryl® is a registered trademark of General Electric Company

| PUMP TYPE | HP | MOTOR S.F. | PH | VOLTS | NEMA FRAME SIZE | DISC SIZE NPT | SUC SIZE NPT | FIG. NO. | PRICE |
|-----------|-----|------------|----|---------|-----------------|---------------|--------------|----------|-------|
| JP5 | 1/2 | 1.6 | 1 | 115/230 | 56J | 1" | 1 1/4" | 38799 | |
| JP7 | 3/4 | 1.5 | 1 | 115/230 | 56J | 1" | 1 1/4" | 38800 | |
| JP10 | 1 | 1.4 | 1 | 115/230 | 56J | 1" | 1 1/4" | 41841 | |

PARALLEL PIPE EJECTOR/FOOT VALVE

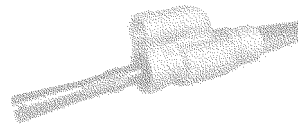

CONTROL VALVE

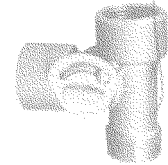

| EJECTOR | FOR USE WITH | HP | NOM. DEPTH | MIN WELL DIA | PRESSURE CONNECT | SUCTION CONNECT | FIG. NO. | PRICE |
|---------|--------------|-----|------------|--------------|------------------|-----------------|----------|-------|
| 5050 | JS-5 | 1/2 | 50' | 4" | 1" | 1 1/4" | 40691 | |
| 5100 | JS-5 | 1/2 | 100' | 4" | 1" | 1 1/4" | 40692 | |
| 7050 | JS-7 | 3/4 | 50' | 4" | 1" | 1 1/4" | 40693 | |
| 7100 | JS-7 | 3/4 | 100' | 4" | 1" | 1 1/4" | 40694 | |
| 10050 | JS-10 | 1 | 50' | 4" | 1" | 1 1/4" | 44368 | |
| 10100 | JS-10 | 1 | 100' | 4" | 1" | 1 1/4" | 44369 | |

| SIZE | FIG. NO. | PRICE |
|------|----------|-------|
| 1" | 40695 | |

SHALLOW WELL JET PUMPS

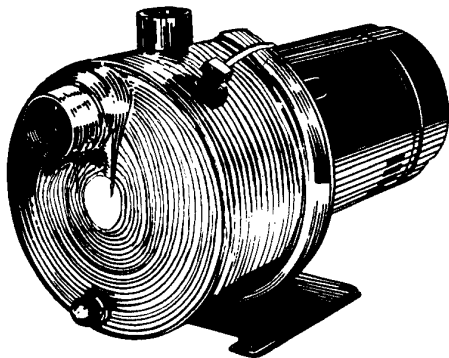

Materials of Construction

| DESCRIPTION | MATERIAL |
|--------------------|-------------------------|
| Motor Stool | E-Coated Aluminum |
| Shaft Seal | Carbon/Ceramic/EPDM |
| O-Rings & Gaskets | EPDM |
| Base Plate | AISI 304 SS |
| Pump Housing (Cap) | AISI 304 SS |
| Impeller | AISI 304/316 SS |
| Tubing | Polyethylene |
| Seal Plate | AISI 304 SS |
| Ejector/Guide Vane | AISI 304 SS/EPDM/Noryl® |

NOTES: EPDM - Ethylene Propylene Rubber
Noryl® is a registered trademark of General Electric Company

| PUMP TYPE | HP | MOTOR S.F. | PH | VOLTS | NEMA FRAME SIZE | DISC SIZE NPT | SUC SIZE NPT | FIG. NO. | PRICE |
|-----------|-----|------------|----|---------|-----------------|---------------|--------------|----------|-------|
| JP-5 | 1/2 | 1.6 | 1 | 115/230 | 56J | 1" | 1 1/4" | 53593 | |
| JP-7 | 3/4 | 1.5 | 1 | 115/230 | 56J | 1" | 1 1/4" | 53594 | |
| JP-10 | 1 | 1.4 | 1 | 115/230 | 56J | 1" | 1 1/4" | 53595 | |

For additional information call: 610-275-4453 or Fax: 610-279-6299
Please call for current prices.

GRUNDFOS JET STAR BOOSTER PUMP

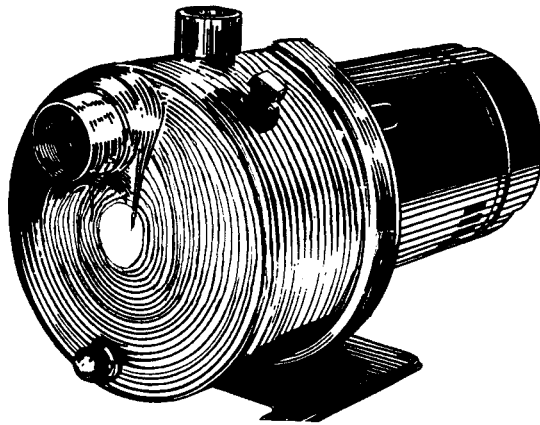

Technical Data

FLOW RANGE: 1 - 40 GPM

MOTORS: ODP (Open Drip Proof)

MAX. FLUID TEMPERATURE: 95°F

MAX. WORKING PRESSURE: 85 psig

Performance Curves

JB50 1/2 HP

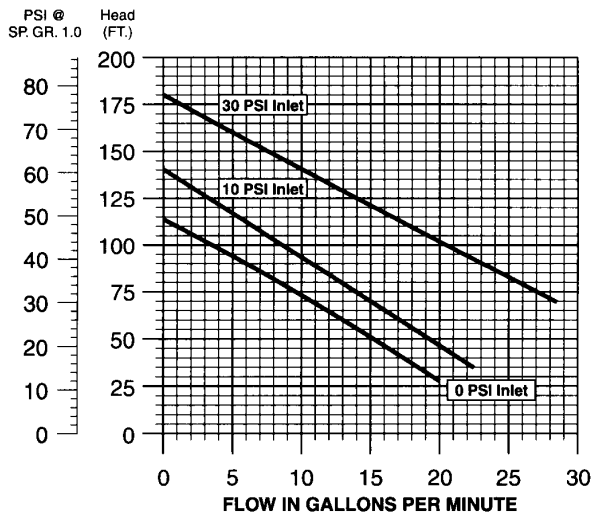

JB70 3/4 HP

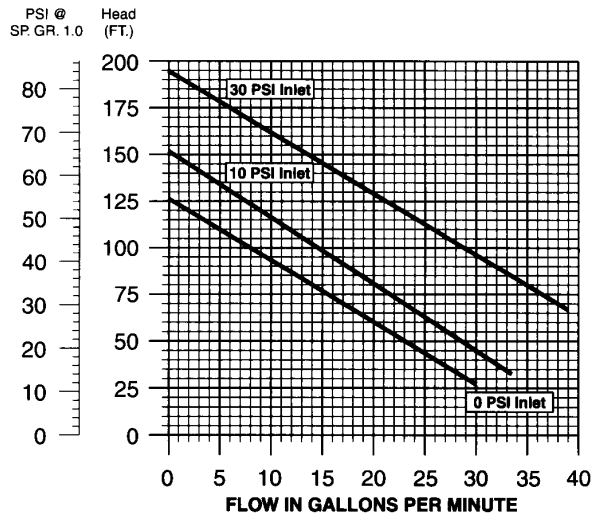

JB100 1 HP

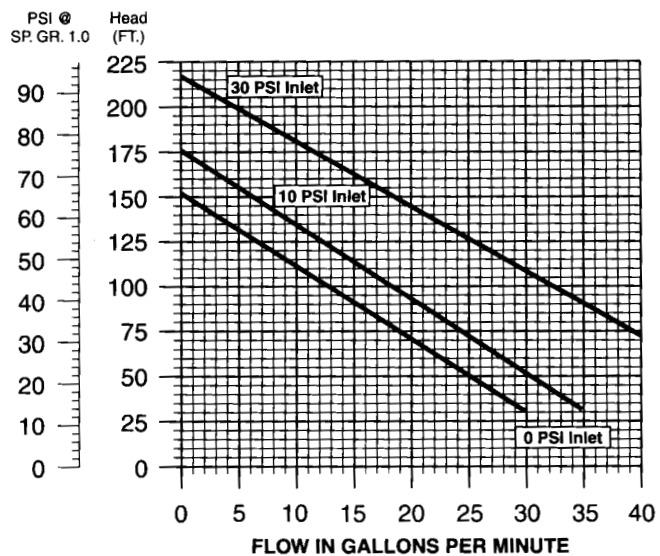

GRUNDFOS JETPAQ A COMPLETE PUMP SYSTEM



SUBMITTAL DATA

50/60 HERTZ

The JetPaq is a complete pumping system with pump, tank, and pressure switch integrated into one compact unit. The pump uses a Micro Frequency Converter to continually adjust speed to meet your pre-set pressure setting

ELECTRICAL DATA AND DIMENSIONS

| FIG. NO. | Model | AMP | PH | Volts | A | B | C | D | E | F | G | H | I | PRICE |
|----------|-------|------|----|-------|-----|-----|-----|----|-----|-----|-----|-----|-----|-------|
| 58560 | JQ2 | 9.0 | 1 | 115 | 7.8 | 7.5 | 8.8 | 18 | 4.7 | 6.6 | 5.6 | 4.5 | 5.7 | |
| 58561 | JQ2 | 5.5 | 1 | 230 | 7.8 | 7.5 | 8.8 | 18 | 4.7 | 6.6 | 5.6 | 4.5 | 5.7 | |
| 58562 | JQ4 | 13.0 | 1 | 115 | 7.8 | 7.5 | 8.8 | 18 | 4.7 | 6.6 | 5.6 | 4.5 | 5.7 | |
| 58563 | JQ4 | 8.0 | 1 | 230 | 7.8 | 7.5 | 8.8 | 18 | 4.7 | 6.6 | 5.6 | 4.5 | 5.7 | |

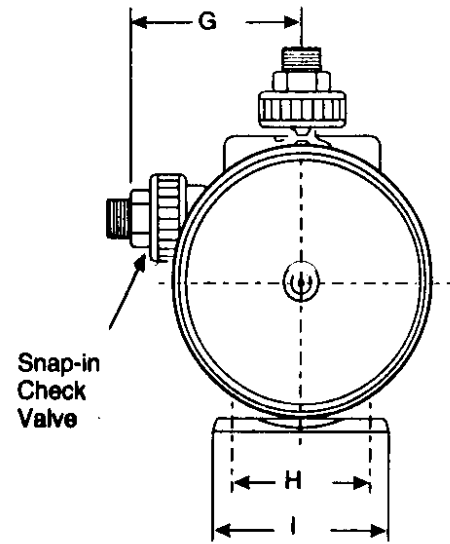
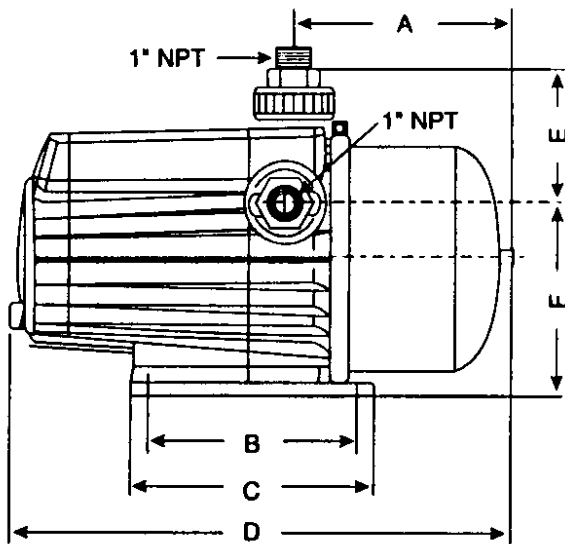

- *DO AWAY WITH YOUR STORAGE TANK
- *TO REPRESSURIZE YOUR SYSTEM
- *OR FOR GENERAL BOOSTER APPLICATION

USE THE JETPAQ!

SUBMERSIBLE PUMP CABLE

600 VOLT - TWISTED - PVC INSULATION - WITH GROUND

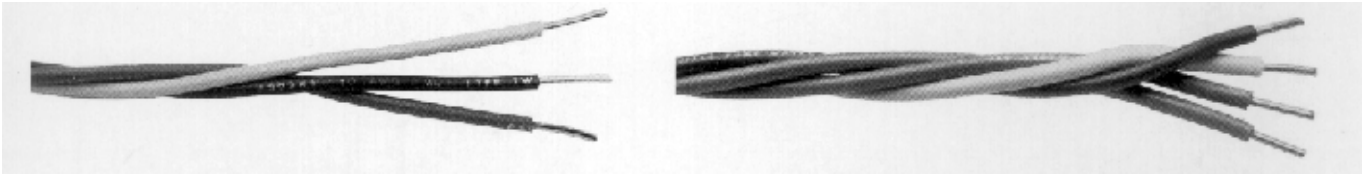

| AWG SIZE | FIG. NO. | SHIP WT. | PRICE |
|----------|----------|----------|-------|
| 12/2 | 49731 | 107 | |
| 12/3 | 49735 | 140 | |
| 10/2 | 49732 | 150 | |
| 10/3 | 49736 | 200 | |
| 8/2 | 49733 | 254 | |
| 8/3 | 49739 | 338 | |
| 6/3 | 49729 | 450 | |
| 4/3 | n/a | 627 | |

**FOR LARGER SIZES, PLEASE CALL US!
610-275-4453**

600 VOLT - FLAT PARALLEL - PVC INSULATION - WITH GROUND

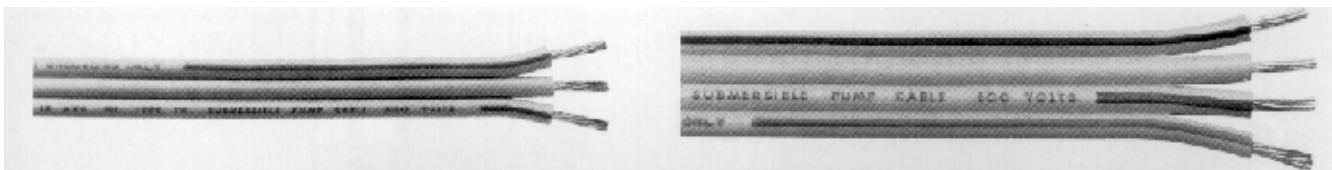

| AWG SIZE | FIG. NO. | SHIP WT. | PRICE |
|----------|----------|----------|-------|
| 12/2 | 49741 | 113 | |
| 12/3 | 49742 | 132 | |

Application: For use within the well casing supplying current to the submersible pump. Maximum conductor operating temperatures of 60° C in circuits not exceeding 600 volts.

UNDERGROUND FEEDER CABLE TYPE UF-B WITH GROUND PVC CONDUCTORS, NYLON JACKET

APPLICATIONS

Kalas Type UF-B underground feeder and branch circuit cable is UL Listed and meets the requirements of UL83, UL493 and Federal specification JC-30B. It is suitable for installation and use as defined by Article 339 of the National Electrical code at voltages up to 600 volts at a conductors temperature of 60°F. It may be installed in exposed and concealed locations, in dry, moist damp or corrosive environments, in outside and inside walls of masonry and tile, and direct buried. It may also be exposed to the direct rays of the sun.



| AWG SIZE | FIG. NO. | SHIP WT. | PRICE |
|----------|----------|----------|-------|
| 12/2 | 53433 | 97 | |
| 12/3 | 53434 | 152 | |

TYPE RED WIRE NUTS

100 to a box. Red 18-10 AWG.



| FIG. NO. | PRICE |
|----------|-------|
| 44593 | |

STA-KON

STA-KON ONLY. Packed 10 to a box.

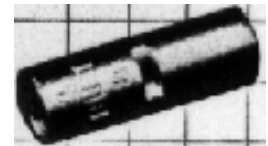

| FIG. NO. | PRICE |
|----------|-------|
| 20174 | |

ELECTRICAL TAPE

3/4" X 60"



| FIG. NO. | PRICE |
|----------|-------|
| 15332 | |

HEAT SHRINK SPLICE KIT.

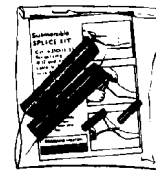

| SIZE | FIG. NO. | PRICE |
|------|----------|-------|
| 2 | 10827 | |
| 3 | 10829 | |
| 4 | 47006 | |

For additional information call: 610-275-4453 or Fax: 610-279-6299
Please call for current prices.

WIRE SELECTION CHART FOR SUBMERSIBLE MOTORS

1. Select wire size for which maximum length equals or exceeds that required. Note that warranty is voided by use of smaller size or longer length than those recommended. Wire sizes comply with table 310-16, column 2 of National Electrical Code (1975 Edition). Allowable ampacity of insulated copper conductors (which covers type RHW, RUH and THWN conductors).

2. Voltage at service entrance will be rated voltage i.e. 225, 200, 230, 460, 575. (This is the 60 Hertz voltage assumed to be available at the service entrance.)

3. Voltage at the motor shall be at least 95% of service entrance voltage with the motor running under normal operating conditions.

4. Cable lengths are based on one continuous wire size run from the service entrance to the motor terminals rather than breaking down into different sizes for supply and drop cable. The portion of the total cable length which is between the service entrance and single phase motor control box should not exceed 25% of the total maximum allowable, to insure proper control of box operation.

2 & 3 Wire Single Phase Franklin Motors

| MOTOR | | MAXIMUM FEET OF COPPER CABLE, SIZE | | | | | | | | | | |
|-------|-------|------------------------------------|-----|------|------|------|------|------|------|------|------|------|
| Volts | HP | 14 | 12 | 10 | 8 | 6 | 4 | 2 | 0 | 00 | 000 | 0000 |
| 115 | 1/3 | 130 | 210 | 340 | 540 | 840 | 1300 | 1960 | 2910 | | | |
| | 1/2 | 100 | 160 | 250 | 390 | 620 | 960 | 1460 | 2160 | | | |
| 230 | 1/3 | 550 | 880 | 1390 | | | | | | | | |
| | 1/2 | 400 | 650 | 1020 | | | | | | | | |
| | 3/4 | 300 | 480 | 760 | 1200 | | | | | | | |
| | 1 | 250 | 400 | 630 | 990 | 1540 | | | | | | |
| | 1-1/2 | 190 | 310 | 480 | 770 | 1200 | 1870 | | | | | |
| | 2 | 150 | 250 | 390 | 620 | 970 | 1530 | 2360 | | | | |
| | 3 | 120 | 190 | 300 | 470 | 750 | 1190 | 1850 | 2890 | | | |
| | 5 | 0 | 110 | 180 | 280 | 450 | 710 | 1110 | 1740 | | | |
| | 7-1/2 | | | 120 | 200 | 310 | 490 | 750 | 1140 | 1410 | 1720 | |
| | 10 | | | | 160 | 250 | 390 | 600 | 930 | 1160 | 1430 | 1760 |

Three Phase Franklin Motors

| MOTOR | | MAXIMUM FEET OF COPPER CABLE, SIZE | | | | | | | | | | |
|---|-------------------------------------|------------------------------------|------|------|------|------|------|------|------|------|------|------|
| Volts | HP | 14 | 12 | 10 | 8 | 6 | 4 | 2 | 0 | 00 | 000 | 0000 |
| 200V 60Hz | 1-1/2 | 310 | 500 | 790 | 1260 | 1960 | 3050 | | | | | |
| | 2 | 240 | 390 | 610 | 970 | 1520 | 2360 | 3610 | 5420 | | | |
| | 3 | 180 | 290 | 470 | 740 | 1160 | 1810 | 2760 | 4130 | | | |
| | 5 | 110 | 170 | 280 | 440 | 690 | 1080 | 1660 | 2490 | 3050 | 3670 | 4440 |
| | 7-1/2 | 0 | 0 | 200 | 310 | 490 | 770 | 1180 | 1770 | 2170 | 2600 | 3150 |
| | 10 | 0 | 0 | 150 | 230 | 370 | 570 | 880 | 1330 | 1640 | 1970 | 2390 |
| | 15 | 0 | 0 | 0 | 160 | 250 | 390 | 600 | 910 | 1110 | 1340 | 1630 |
| | 20 | 0 | 0 | 0 | 0 | 190 | 300 | 460 | 700 | 860 | 1050 | 1270 |
| | 25 | 0 | 0 | 0 | 0 | 0 | 240 | 370 | 570 | 700 | 840 | 1030 |
| | 230V 60Hz and 220V 50Hz | 1-1/2 | 420 | 670 | 1060 | 1670 | 2610 | 4050 | 6160 | 9170 | | |
| 2 | | 320 | 510 | 810 | 1280 | 2010 | 3130 | 4770 | 7170 | 8780 | | |
| 3 | | 240 | 390 | 620 | 990 | 1540 | 2400 | 3660 | 5470 | 6690 | 8020 | 9680 |
| 5 | | 140 | 230 | 370 | 590 | 920 | 1430 | 2190 | 3290 | 4030 | 4850 | 5870 |
| 7-1/2 | | 0 | 160 | 260 | 420 | 650 | 1020 | 1560 | 2340 | 2870 | 3440 | 4160 |
| 10 | | 0 | 0 | 190 | 310 | 490 | 760 | 1170 | 1760 | 2160 | 2610 | 3160 |
| 15 | | 0 | 0 | 0 | 210 | 330 | 520 | 800 | 1200 | 1470 | 1780 | 2150 |
| 20 | | 0 | 0 | 0 | 160 | 250 | 400 | 610 | 930 | 1140 | 1380 | 1680 |
| 25 | | 0 | 0 | 0 | 0 | 200 | 320 | 500 | 750 | 920 | 1120 | 1360 |
| 30 | | 0 | 0 | 0 | 0 | 0 | 260 | 410 | 620 | 760 | 930 | 1130 |
| 460V 60Hz and 380V- 460V 50Hz (Divide lengths by 1.4 for 380V 60Hz) | 1-1/2 | 1700 | 2710 | 4270 | 6730 | | | | | | | |
| | 2 | 1300 | 2070 | 3270 | 5150 | 8050 | | | | | | |
| | 3 | 1000 | 1600 | 2520 | 3970 | 6200 | | | | | | |
| | 5 | 590 | 950 | 1500 | 2360 | 3700 | 5750 | | | | | |
| | 7-1/2 | 420 | 680 | 1070 | 1690 | 2640 | 4100 | 6260 | | | | |
| | 10 | 310 | 500 | 790 | 1250 | 1960 | 3050 | 4680 | 7050 | | | |
| | 15 | 0 | 340 | 540 | 850 | 1340 | 2090 | 3200 | 4810 | 5900 | 7110 | |
| | 20 | 0 | 0 | 410 | 650 | 1030 | 1610 | 2470 | 3730 | 4580 | 5530 | |
| | 25 | 0 | 0 | 330 | 530 | 830 | 1300 | 1990 | 3010 | 3700 | 4470 | 5430 |
| | 30 | 0 | 0 | 270 | 430 | 680 | 1070 | 1640 | 2490 | 3060 | 3700 | 4500 |
| 575V 60Hz | 1-1/2 | 2620 | 4180 | 6580 | | | | | | | | |
| | 2 | 2030 | 3250 | 5110 | 8060 | | | | | | | |
| | 3 | 1580 | 2530 | 3980 | 6270 | | | | | | | |
| | 5 | 920 | 1480 | 2330 | 3680 | 5750 | | | | | | |
| | 7-1/2 | 660 | 1060 | 1680 | 2650 | 4150 | | | | | | |
| | 10 | 490 | 780 | 1240 | 1950 | 3060 | 4770 | | | | | |
| | 15 | 330 | 530 | 850 | 1340 | 2090 | 3260 | | | | | |
| | 20 | 0 | 410 | 650 | 1030 | 1610 | 2520 | 3860 | 5830 | | | |
| | 25 | 0 | 0 | 520 | 830 | 1300 | 2030 | 3110 | 4710 | | | |
| | 30 | 0 | 0 | 430 | 680 | 1070 | 1670 | 2560 | 3880 | 4770 | 5780 | 7030 |
| 40 | 0 | 0 | 0 | 500 | 790 | 1240 | 1900 | 2860 | 3510 | 4230 | 5140 | |
| 50 | 0 | 0 | 0 | 410 | 640 | 1000 | 1540 | 2310 | 2840 | 3420 | 4140 | |
| 60 | 0 | 0 | 0 | 0 | 540 | 850 | 1300 | 1960 | 2400 | 2890 | 3500 | |
| 75 | 0 | 0 | 0 | 0 | 0 | 690 | 1060 | 1600 | 1970 | 2380 | 2890 | |
| 100 | 0 | 0 | 0 | 0 | 0 | 0 | 790 | 1190 | 1460 | 1770 | 2150 | |

PRESSURE SWITCHES AND CONTROL SYSTEMS

PRESSURE SWITCHES

These electric control pressure switches are dependable and sure-acting for all water systems. Easy to install and easy to service, each switch has a removable cover that exposes the entire mechanism and the electrical leads. The contacts are of fine silver, double break type that permit a more efficient flow of current.

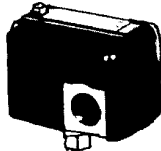

FSG-2

| FSG-2 | FIG. NO. | PRICE |
|----------|----------|-------|
| 20/40 | 8229 | |
| 30/50 | 8254 | |
| 30/50 G5 | 8267 | |
| 30/50 P | 50216 | |
| 40/60 | 45486 | |
| 30/50 M4 | 8286 | |

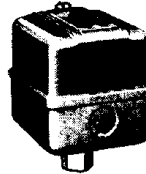

GSG-2 OR
GHG-2

| GHG-2 | FIG. NO. | PRICE |
|--------|----------|-------|
| 80/100 | 25322 | |

| GSG-2 | FIG. NO. | PRICE |
|-------|----------|-------|
| 20/40 | 8307 | |
| 30/50 | 8317 | |
| 40/60 | 8327 | |
| 50/70 | 8347 | |
| 60/80 | 8361 | |



ELECTRODES

| Fig. No. | Probes | Unit Wt | PRICE |
|----------|--------------------|---------|-------|
| 27964 | Stainless Steel | 1 oz. | |
| 10673 | Brass | 1 oz. | |

FLOATLESS LIQUID LEVEL CONTROL SYSTEMS

Provides automatic low level cutoff protection for submersible pumps and deep well turbines. Liquid level submersible pump control system consists of a standard enclosed type LH induction relay which operates from two type E1-S insulated electrodes suspended at desired levels. Properly installed, these components provide reliable automatic low level cutoff protection for submersible pumps and deep well turbines. Permits efficient operation at full capacity and eliminated danger of pumping air or sand.

Type LH Relay - the LH relay is rated 1 hp, single phase, 110 or 220 volts and normally furnished in a NEMA 1 metal enclosure. For control of a larger motor, it can also be supplied in a common enclosure with an auxiliary relay without overload protection or with a magnet starter that has overload protection.

Wiring diagrams and complete installation instruction are included with each control.

Type E1-S Electrodes - Made of brass or stainless steel, these 2" long electrodes are assembled in molded plastic insulating shields and suspended at desired levels in well by means of suspension wire.

RELAYS

| Fig. NO. | Operation | Application | Unit Wt. | Price |
|----------|-----------|-------------|----------|-------|
| | Pump Down | Submersible | 4 LBS | |
| | Pump Up | Open Sys | 4 LBS | |



CALL DUFF FIRST!

610-275-4453

For additional information call: 610-275-4453 or Fax: 610-279-6299
Please call for current prices.



SUSPENSION WIRE

Designed to provide maximum strength and insulation, the wire is single conductor 18 gauge, 41 strand copper with 4/64" vinyl insulation.

| FIG. NO. | PRICE |
|----------|-------|
| 28163 | |

SUBGARD II LIQUID LEVEL CONTROL

**A GREAT PROVEN IDEA NOW EVEN
GREATER!**

The new Subgard II Ranger offers you more protection for your submersible pump than ever before possible. Greater circulation range. A greater range of applications including use in "sandy" well without the risk of jamming.

- * Level sensing float
- * Completely mechanical
- * Assures maximum water yield of the well at all times
- * Strongly and simply constructed
- * Prevents overpumping and pump burnout
- * No costly interruptions in service
- * Warranted for three full years
- * Available in sizes ranging from 1" through 4" riser pipes

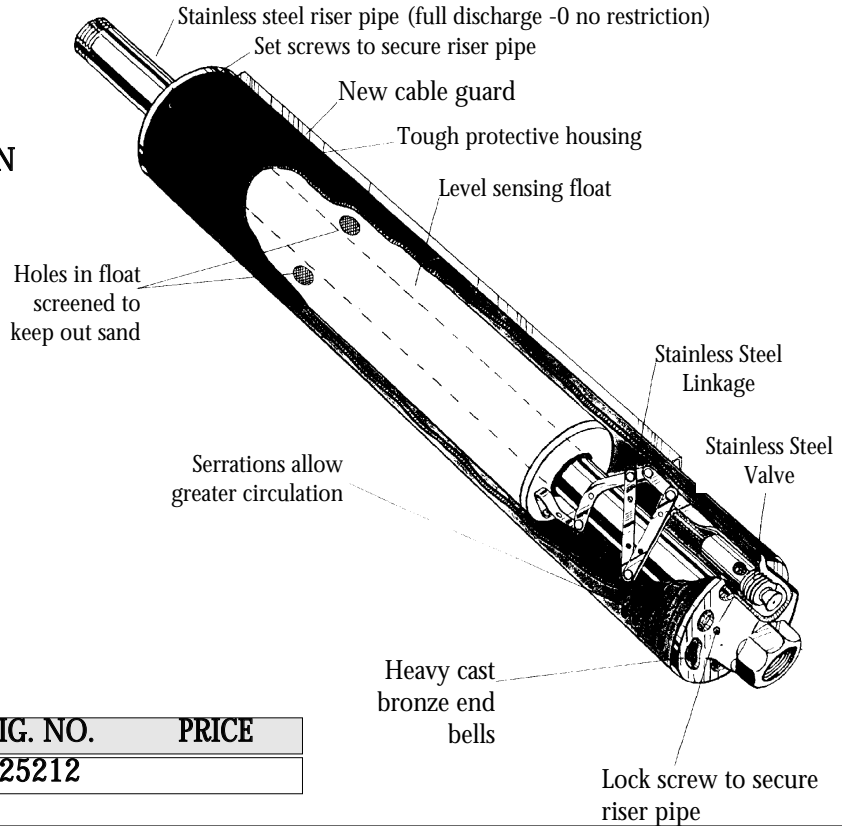

| FIG. NO. | PRICE |
|----------|-------|
| 25212 | |

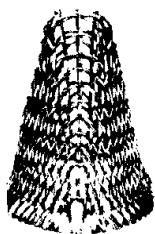

EJECTOR SCREEN

Protects jet pumps against plugged nozzles clogged venturis. Installs easily in discharge side of ejector.

| SIZE | FIG. NO. | PRICE |
|-------|----------|-------|
| Brass | 10655 | |
| SS | 35863 | |

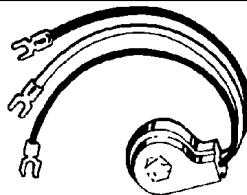

LIGHTNING SURGE ARRESTOR

Specify one Θ or three Θ . When lightning or voltage surge of 500 volts or more reaches the lightning arrestor, the metal oxide within the plastic casing begins conducting the surge to the ground, relieving the electrical pressure to the motor. Regular operation is resumed as soon as the surge is passed to the ground.

| DESCR | FIG. NO. | PRICE |
|------------|----------|-------|
| 1 Θ | 8049 | |
| 3 Θ | 10940 | |



COYOTE PROTECTS PUMPS AND MOTORS from RUNNING DRY

All above ground, no plumbing, no probes. Works on both 2 and 3 wire motors. Covers a wide horsepower range. Restarts automatically with adjustable timer. Operates alone or with pressure switches, float switches, or tank pump-up controls. Contacts to activate alarm available as an option. 3 Phase also available. CALL FOR SPECS!

| DESCR | FIG. NO. | PRICE |
|-------------------|----------|-------|
| 1/3 to 1 HP, 115V | 30070 | |
| 1/3 to 2 HP, 230V | 30071 | |

| TECHNICAL SPECIFICATIONS | | |
|--------------------------|----------------|----------------|
| Nominal Voltage | 115V | 230V |
| Operating Range | 90V-130V | 180V-260V |
| Horsepower Rating | 1/3-1 | 1/3-2 |
| Trip delay | 1.5 seconds | 1.5 seconds |
| Reset delay | adjustable | adjustable |
| | 15 min.-5 hrs. | 15 min.-5 hrs. |
| Operating temperature | -20 to 75°C | -20 to 75°C |
| Trip % of normal load | adjustable | adjustable |
| | 80 - 86% | 80 - 86% |

Model 115 V
1/3 - 1 HP



Model 230 V
1/3 - 2 HP



MOTOR CONTROLS & ACCESSORIES

Franklin Submersible Motor Controls

PumpTec Features:

- For single phase motors 1/3 - 1 1/2HP, 115/230V, 2 or 3 wire.
- Protects against low-yield wells, drop in water level and low voltage.
- Manual or Auto Reset (2 min. - 90 min.)

PumpTec Plus Features:

- For single phase motors 1/2 - 5HP, 230V, 2 or 3 wire
- Protects against low-yield wells, high or low voltage, drop in water level, rapid cycling, water logged tank.
- Manual or Auto Reset (1 min. - 4 hrs.)
- Run and Fault indicator lights.

QD PumpTec Features:

- For Franklin 3-Wire single phase submersible motors 1/3-1HP, 230V.
- Protects against low-yield wells, drop in water level, broken shaft or coupling, clogged well screen, air or gas locked pump, and low voltage.
- Auto or manual reset
- Surge resistant.
- Moisture and insect resistant.
- Solid state electronic circuitry.
- Mounts in existing Franklin Control Box.

| FIG. NO. | MODEL NO. | WT. | PRICE |
|----------|---------------|-----|-------|
| 42781 | Pump Tec | 3 | |
| 48773 | Pump Tec Plus | 6 | |



Pump Tec



Pump Tec Plus

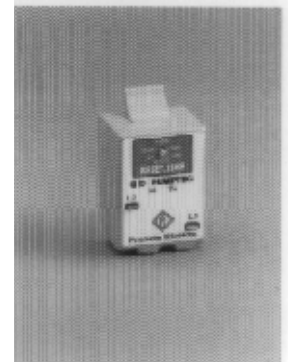

DUFF IS HAPPY TO
ACCEPT
VISA AND MASTERCARD!

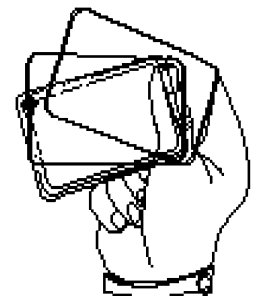

4" FRANKLIN SUBMERSIBLE PUMP MOTORS

| HP | PH | VOLTS | MAX THRUST (LBS) | FIG. NO. | PRICE |
|--|----|-------|---------------------|----------|-------|
| TWO WIRE (Control Box Not Required) | | | | | |
| 1/3 | 1 | 115 | 650 | 6410 | |
| | 1 | 230 | 650 | 6421 | |
| 1/2 | 1 | 115 | 650 | 6418 | |
| | 1 | 230 | 650 | 6425 | |
| 3/4 | 1 | 230 | 650 | 6450 | |
| 1 | 1 | 230 | 650 | 6445 | |
| 1 1/2 | 1 | 230 | 650 | 6454 | |
| THREE WIRE (Control Box Not Required) | | | | | |
| 1/3 | 1 | 115 | 300 | 6460 | |
| | 1 | 230 | 300 | 6469 | |
| 1/2 | 1 | 115 | 300 | 6464 | |
| | 1 | 230 | 300 | 6471 | |
| 3/4 | 1 | 230 | 300 | 6476 | |
| 1 | 1 | 230 | 650 | 6480 | |
| 1 1/2 | 1 | 230 | 650 | 6486 | |
| | 3 | 200 | 650 | 44285 | |
| | 3 | 230 | 650 | 30059 | |
| | 3 | 460 | 650 | 30060 | |
| | 1 | 230 | 650 | 6489 | |
| 2 | 3 | 200 | 650 | 42801 | |
| | 3 | 230 | 650 | 6520 | |
| | 3 | 460 | 650 | 6526 | |
| 3*** | 1 | 230 | 1500 | 6497 | |
| | 3 | 200 | 1500 | 38928 | |
| | 3 | 230 | 1500 | 6529 | |
| | 3 | 460 | 1500 | 6534 | |
| 5*** | 1 | 230 | 1500 | 6503 | |
| | 3 | 200 | 1500 | 38916 | |
| | 3 | 230 | 1500 | 6538 | |
| | 3 | 460 | 1500 | 6543 | |
| 7 1/2 | 3 | 200 | 1500 | 47908 | |
| | 3 | 230 | 1500 | 41212 | |
| | 3 | 460 | 1500 | 41213 | |
| 10 | 3 | 460 | 1500 | 41214 | |

6" FRANKLIN SUBMERSIBLE PUMP MOTORS

| HP | PH | VOLTS | MAX THRUST (LBS) | FIG. NO. | PRICE |
|-------|----|-------|---------------------|----------|-------|
| 5 | 1 | 230 | 1500 | | |
| | 3 | 230 | 1500 | | |
| | 3 | 460 | 1500 | | |
| 7 1/2 | 1 | 230 | 1500 | 6513 | |
| | 3 | 200 | 1500 | 49132 | |
| | 3 | 230 | 1500 | 6547 | |
| | 3 | 460 | 3500 | 6551 | |
| 10 | 1 | 230 | 3500 | 30057 | |
| | 3 | 200 | 3500 | 49133 | |
| | 3 | 230 | 3500 | 6555 | |
| | 3 | 460 | 3500 | 6559 | |
| 15 | 1 | 230 | 3500 | 49134 | |
| | 3 | 200 | 3500 | 49135 | |
| | 3 | 230 | 3500 | 6564 | |
| | 3 | 460 | 3500 | 6569 | |
| 20 | 3 | 200 | 3500 | 21116 | |
| | 3 | 230 | 3500 | 6572 | |
| | 3 | 460 | 3500 | 6578 | |
| 25 | 3 | 200 | 3500 | 49136 | |
| | 3 | 230 | 3500 | 6584 | |
| | 3 | 460 | 3500 | 6586 | |
| 30 | 3 | 200 | 3500 | 49137 | |
| | 3 | 230 | 3500 | 44286 | |
| | 3 | 460 | 3500 | 44287 | |
| 40 | 3 | 460 | 3500 | 47400 | |
| 50 | 3 | 460 | 3500 | 47401 | |
| 60 | 3 | 460 | 3500 | 47402 | |

8" & 10" SUBMERSIBLE PUMP MOTORS

| 8 INCH | | | | | |
|---------|---|-----|--------|-------|--|
| 40 | 3 | 460 | 10,000 | 47400 | |
| 50 | 3 | 460 | 10,000 | 47401 | |
| 60 | 3 | 460 | 10,000 | 47402 | |
| 75 | 3 | 460 | 10,000 | 47406 | |
| 100 | 3 | 460 | 10,000 | 27392 | |
| 125 | 3 | 460 | 10,000 | 47407 | |
| 150 | 3 | 460 | 10,000 | 47408 | |
| 175 | 3 | 460 | 10,000 | 67141 | |
| 200 | 3 | 460 | 10,000 | 67142 | |
| 10 INCH | | | | | |
| 175 | 3 | 460 | 10,000 | 47435 | |
| 200 | 3 | 460 | 10,000 | 47409 | |
| 250 | 3 | 460 | 10,000 | 47410 | |

DUFF CO.

MAGNETIC STARTERS

PUMPS

6" Dia. Motors

4" Dia. Motors

| HP | VOLTS | STARTER SIZE | FURNAS AMB. COMP. | FIG. NO. | PRICE |
|-----|-------|--------------|-------------------|----------|-------|
| 1 | 200 | 00 | K43 | 25591 | |
| 1/2 | 230 | 00 | K41 | 21083 | |
| | 460 | 00 | K29 | 66100 | |
| | 575 | 00 | K27 | | |
| 2 | 200 | 0 | K50 | 20510 | |
| | 230 | 0 | K49 | 25592 | |
| | 460 | 00 | K33 | 74361 | |
| | 575 | 00 | K29 | 66100 | |
| 3 | 200 | 0 | K54 | | |
| | 230 | 0 | K52 | 25593 | |
| | 460 | 0 | K37 | | |
| | 575 | 0 | K33 | 74361 | |
| 5 | 200 | 1 | K61 | 25598 | |
| | 230 | 1 | K61 | 25598 | |
| | 460 | 0 | K49 | 25592 | |
| | 575 | 0 | K42 | 25590 | |
| 7 | 200 | 1 | K68 | 29722 | |
| 1/2 | 230 | 1 | K67 | 25601 | |
| | 460 | 1 | K55 | 25596 | |
| | 575 | 1 | K52 | 25593 | |
| | 460 | 1 | K58 | 76390 | |
| | 575 | 1 | K55 | 25596 | |

| HP | VOLTS | STARTER SIZE | FURNAS AMB. COMP. | FIG. NO. | PRICE |
|-------|-------|--------------|-------------------|----------|-------|
| 5 | 200 | 1 | K61 | 25598 | |
| | 230 | 1 | K61 | 25598 | |
| | 460 | 0 | K49 | 25592 | |
| | 575 | 0 | K42 | 25590 | |
| 7 1/2 | 200 | 1 | K68 | 29722 | |
| | 230 | 1 | K67 | 25601 | |
| | 460 | 1 | K55 | 25596 | |
| | 575 | 1 | K52 | 25593 | |
| 10 | 200 | 1 3/4 | K72 | 10606 | |
| | 230 | 1 3/4 | K70 | 10601 | |
| | 460 | 1 | K58 | 76390 | |
| | 575 | 1 | K55 | 25596 | |
| 15 | 200 | 2 1/2 | K76 | 17465 | |
| | 230 | 2 | K75 | 10717 | |
| | 460 | 1 3/4 | K64 | 25600 | |
| | 575 | 1 3/4 | K61 | 25598 | |
| 20 | 200 | 3 | K78 | 10651 | |
| | 230 | 2 1/2 | K77 | 10628 | |
| | 460 | 2 | K69 | 25602 | |
| | 575 | 2 | K64 | 25600 | |
| 25 | 200 | 3 | K86 | 10692 | |
| | 230 | 3 | K83 | 69320 | |
| | 460 | 2 | K72 | 10606 | |
| | 575 | 2 | K69 | 25602 | |
| 30 | 200 | 3 1/2 | K88 | 74629 | |
| | 230 | 3 | K72 | 10606 | |
| | 460 | 2 1/2 | K69 | 25602 | |
| | 575 | 2 1/2 | K88 | 74629 | |
| 40 | 460 | 3 | K87 | 10672 | |
| | 575 | 3 | K74 | 10680 | |
| 50 | 460 | 3 | K72 | 10606 | |
| | 575 | 3 | K77 | 10628 | |

Magnetic Starters

Non-reversing with reset bimetal type thermal overload relay; NEMA1 General Purpose Enclosures; 600 volts AC Maximum; 3-phase; 3-pole; 3-bimetal overloads.
CALL FOR SIZING & PRICES.

CONTROL BOXES

| HP | VOLTS | FIG. NO. | MODEL # | PRICE |
|-----------------------------------|-------|----------|-------------|-------|
| FRANKLIN For 4-Inch Motors | | | | |
| 1/3 | 115 | 6590 | F280 10 201 | |
| | 230 | 6597 | F280 10 301 | |
| 1/2 | 115 | 6592 | F280 10 401 | |
| | 230 | 6602 | F280 10 501 | |
| 3/4 | 230 | 6605 | F280 10 701 | |
| 1 | 230 | 6606 | F280 10 801 | |
| 1 1/2 | 230 | 6610 | 82.F 001 | |
| 2 | 230 | 6614 | 82.F 002 | |
| 3 | 230 | 6618 | 82.F 004 | |

FRANKLIN For 6-Inch Motors

| | | | |
|-------|-----|-------|----------|
| 7 1/2 | 230 | 6623 | 82.F 008 |
| 10 | 230 | 30328 | 82.F 010 |

DELUXE CONTROL BOX WITH MAG CONTACT

FRANKLIN

| HP | VOLTS | MOTOR DIA (Inches) | FIG. NO. | MODEL NO. | PRICE |
|-------|-------|--------------------|----------|-----------|-------|
| 2 | 230 | 4 | 43572 | 82.F 003 | |
| 3 | 230 | 4 | 43573 | 82.F 005 | |
| 5 | 230 | 4 & 6 | 41215 | 82.F 007 | |
| 7 1/2 | 230 | 6 | 43574 | 82.F 007 | |
| 10 | 230 | 6 | 43575 | 82.F 011 | |
| 15 | 230 | 6 | 52627 | 82.F 012 | |

PUMP ACCESSORIES

PIPE HOLDER

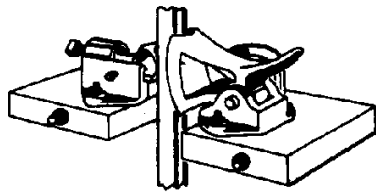

Holds pipe while it is being lowered or raised in well. Adjusts for 1", 1 1/4", 1 1/2", 2"

| FIG. NO. | PRICE |
|----------|-------|
| 10583 | |

TORQUE ARRESTOR TA-48

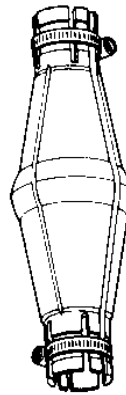

Precision molded from virgin rubber to provide the finest method available for protecting submersible pumps from starting torque damage. Deluxe torque arrestor is field-adjustable to hold pump centered in well, insuring a snug fit in all well casings from 4" - 8" ID. Two piece design installs quickly, eliminates flashing problems, and has a longer life. After easy casing adjustment,

the unit is securely fastened to 1" or 1 1/4" drop pipe with the two stainless steel clamps provided.

SPECIAL FEATURE
(Adjustable 4" to 8")

| FIG. NO. | PRICE |
|----------|-------|
| 10801 | |

CABLE GUARD

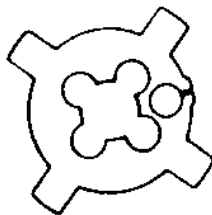

4" or 6" wells. Protects pump and cable.

This cable guard will keep the power cable from abrading against the casing or natural side of the well. A minimum of three to five should be used; one at the pump and one between 25' and 30' above the pump. Furnished in 6" size, although cut tabs permit this unique fitting to be used in 4" and 5" wells. This guard is made of polyethylene and will float. Therefore cable ties, retaining clamps or tape should be used over or under the cable guard.

| DESCRIPTION | FIG. NO. | PRICE |
|----------------------|----------|-------|
| WG-6 Snap-in | 10804 | |
| WG-100 Self Clamping | 43465 | |

AIR FLOAT

Slips into any 1 1/4" opening

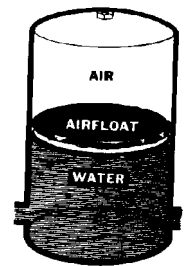

| SIZE | FIG. NO. | PRICE |
|------|----------|-------|
| 16 | 25164 | |
| 20 | 25331 | |
| 24 | 25332 | |

SAFETY ROPE

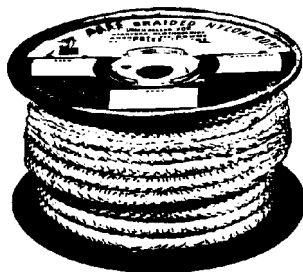

- * 1800 LBS
- * Bursting Strength
- * 1000 ft rolls
- * For submersible pumps

| DESCR | FIG. NO. | PRICE |
|-----------|----------|-------|
| FULL COIL | 41255 | |
| PER FT | 10815 | |

SCHRADER AIR VALVE



| SIZE | FIG. NO. | PRICE |
|------|----------|-------|
| 1/8 | 10607 | |
| 1/4 | 10608 | |

RUBBER BLEEDER

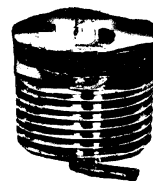

For submersible pump. 1" rubber inserts hand-tite in 1" tee.

| FIG. NO. | PRICE |
|----------|-------|
| 20010 | |

NO ORDER IS TOO SMALL FOR OUR PROMPT ATTENTION!

PITLESS ADAPTERS

PITLESS ADAPTERS

Eliminates pit, seals out surface water, easy to service, no digging, easy to install, red brass.

| SIZE | FIG. NO. | PRICE |
|------------|----------|-------|
| 1" Simmons | 18121 | |
| 1 1/4 | 10627 | |
| 2 | 10637 | |
| 1 x 1 1/4 | 10649 | |

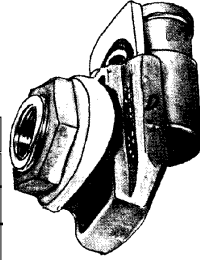

IMPORTED BRASS PITLESS ADAPTER

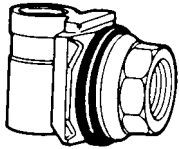

- * Red brass unit precision cast and machined to exacting Harvard specifications
- * One unit fits 5" to 7" well casing
- * Two neoprene gaskets furnished to

protect against outside contamination

- * Designed to support up to 900 lbs. of pipe filled with water plus pump
- * For 1" drop pipe
- * Individually packaged

Tested and meets PAS-1 standards

Brass Pitless adapters packaged with two rubber gaskets and lubricant.

| FIG. NO. | PRICE |
|----------|-------|
| 47964 | |



HEAVY DUTY PVC DROP COUPLING
Machined from extruded PVC stock.

| SIZE | FIG. NO. | PRICE |
|--------|----------|-------|
| 1" | 25320 | |
| 1 1/4" | 29838 | |

HEAVY DUTY

| SIZE | FIG. NO. | PRICE |
|------|----------|-------|
| 1" | 49377 | |

SCH 80 PVC THREADED PIPE 20'

| SIZE | FIG. NO. | PRICE |
|--------|----------|-------|
| 1" | 25117 | |
| 1 1/4" | 25186 | |

SNAPPY PITLESS ADAPTERS

For Submersible Pumps

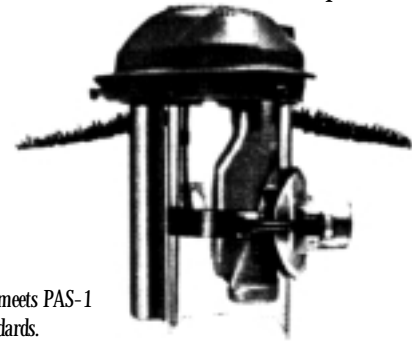

Tested and meets PAS-1 standards.

Clear Hole - No restrictions in the casing installation and retrieval is easy.

Easily Set - Installation is fast. Self-locating, self aligning.

Corrosion Proof - All parts are lead free galvanized cast iron and ductile iron. No dissimilar metals to cause electrolytic or galvanic corrosion. exterior clamping band is all stainless steel.

Protected Potable Seal - Safe and second to none. Potable Oring seal is inside casing fitting, located between accurately machined sealing surfaces beyond the inside wall to the well casing, and is safe from damaging contact with well tools, drop pipe, etc.

Snappy adapters available in combination with ventilated or watertight caps.



Bulldog Brass Pitless Adapter



Bulldog Casing Fitting & Clamp



Bulldog Weld-on Casing Fitting

| FIG. NO. | WELL CASING ID (INCHES) | DROP PIPE SIZE (INCHES) | PRICE |
|----------------|-------------------------|-------------------------|-------|
| 10741 | 4 | 1 | |
| 10744 | 4 | 1 1/4 | |
| 63300 (3 pack) | 4 | 1 | |

4 X 1 BULLDOG PITLESS

Same as Snappy except all brass.

| FIG. NO. | PRICE |
|----------|-------|
| 45140 | |

DOMESTIC PITLESS KIT

DQ SERIES FULL PITLESS KITS consist of the double kwiconect discharge body and spool with o-rings. **Cap must be ordered separately.**

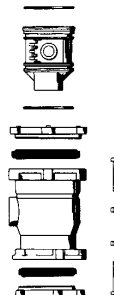

| FIG. NO. | PRICE |
|----------|-------|
| 46929 | |

MAASS MODEL J PITLESSES ARE SANITARY AND EASY TO SERVICE

Recommend to your customers the Maass Model J pitlesses — units create easy well service for you because they are manufactured only of RUST-PROOF materials and designed to eliminate all obstructions in well casing. Pump is easy to pull because of non-rusting components. Water contacts only 304 stainless steel and bronze to COMPLETELY ELIMINATE ANY RUST and/or ELECTROLYSIS. The Maass pitless connection is sealed by using a bronze 8 degree non-locking taper wedge with O-ring forced against 304 non-magnetic stainless steel flanged nipple pressed into steel housing and welded on outer side. Model J Pitless Adapter is non-pressure lifting and is designed for deep wells, higher working pressures, and where plastic pipe is used and high water levels. No lock necessary. Stock only two 1-inch outlet size Maass Model J pitlesses to fit all well casing sizes. Pitless steel housing is permanently installed by welding onto well casing.

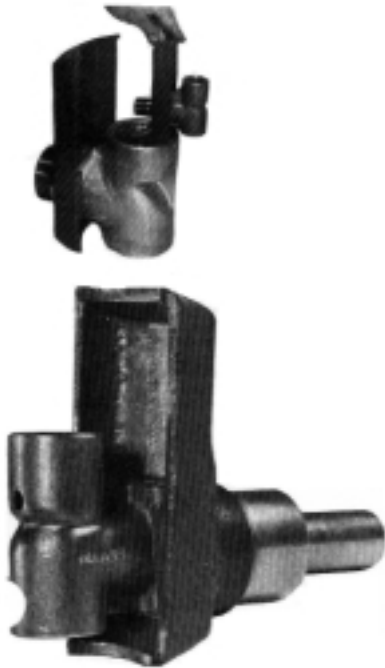

MODEL JJ

MODEL JJ models below are for suction pumps. Lateral can be pressurized to meet state codes.

| WELL CASING SIZE | MODEL | WATER OUTLET & DROP PIPE SIZE |
|------------------|-------|-------------------------------|
| 4"-5" | JJ | 1" outlet 2" lateral |
| 6"-7"-8" | JJ | 1" outlet 2" lateral |
| 4"-5" | JJ | 1 1/4" outlet 2" lateral |
| 6"-7"-8" | JJ | 1 1/4" outlet 2" lateral |

WELD-ON UNITS

| WELL CASING SIZE | MODEL | WATER OUTLET & DROP PIPE SIZE | APPROXIMATE WEIGHT |
|------------------|-------|-------------------------------|--------------------|
| 4"-5" | J | 1" | 6# |
| 4"-5" | J | 1 1/4" | 7# |
| 4"-5" | J | 1 1/2" | 8.5# |
| 5" | J | 2" | 12# |
| 6"-7"-8" | J | 1" | 6# |
| 6"-7"-8" | J | 1 1/4" | 7# |
| 6"-7"-8" | J | 1 1/2" | 8.5# |
| 6"-7"-8" | J | 2" | 12# |
| 6"-7"-8" | J | 2 1/2" | 18# |
| 8"-10"-12" | J | 3" | 32# |
| 10"-12" | J | 4" | 50# |

UP-Z-DAZY PUMP PULLER

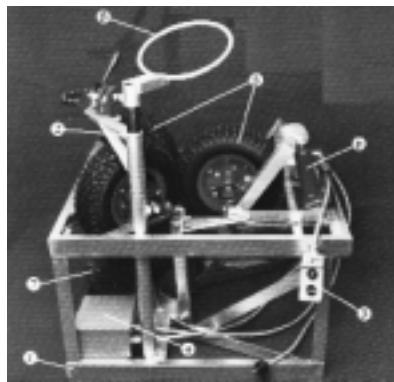

| DESCRIPTION | FIG. NO. | PRICE |
|---|----------|-------|
| Model 30XL aluminum heavy duty (legs incl) | 22378 | |
| Model 20XL aluminum (legs incl) | 22377 | |
| Model 10XL aluminum (monitoring model) | 40688 | |
| Model 2010 cable with attachment (fits all model 10-20-30 machines) | 22379 | |
| Wheel kit (fits all model 10-20-30- machines) | 22380 | |
| Overhead guide | 22381 | |
| Vise complete with vise arm | 22382 | |
| Leg kit (fits model 30XL-20XL; extends to 7 inches) | 37881 | |

For additional information call: 610-275-4453 or Fax: 610-279-6299
 Prices are a guide only. Please call for current prices.

WHY A PITLESS UNIT?

The standard above ground "Wall House" or "Well Pit" left much to be desired as solutions to sanitation, convenience and freeze protection.

Monitor (A Division of Baker Manufacturing) developed the first solution to eliminate the "well house and well pit" - with the Pitless Adapter and Pitless System.

The Pitless system allows the water to be directed to the service underground below the frost line, thus preventing any form of surface contamination.



STANDARD

Monitor

A Division of:
BAKER
 manufacturing company

INDUSTRIAL PITLESS ADAPTER UNITS

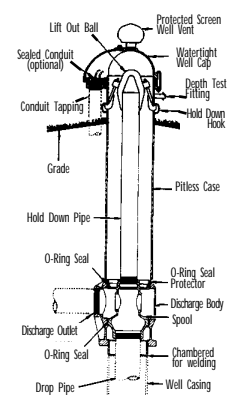

WELL SEALS AND CAPS

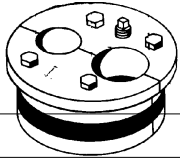

DOUBLE HOLE JET PUMP

| WELL SIZE | PIPE SIZE | CAST IRON | | ABS | |
|-----------|-------------|-----------|-------|----------|-------|
| | | FIG. NO. | PRICE | FIG. NO. | PRICE |
| 3" | 1 X 3/4 | 36276 | - | - | - |
| 4" | 1 X 1 | 35694 | - | - | - |
| 4" | 1 1/4X1 | 10724 | - | 42503 | - |
| 5 5/8" | 1 1/4X1 | 23090 | - | - | - |
| 6" | 1 1/4X1 | 10739 | - | 28162 | - |
| 6" | 1 1/4X1 1/4 | 19758 | - | - | - |
| 6 1/4" | 1 1/4 X 1 | 35695 | - | - | - |
| 6 1/2" | 1 1/4 X 1 | 34717 | - | - | - |
| 6 5/8" | 1 1/4 X 1 | 38705 | - | - | - |
| 6" | 1 X 1 | 49182 | - | - | - |
| 6" | 1 X 3/4 | 51452 | - | - | - |

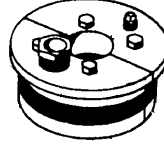

SINGLE HOLE JET PUMP

| WELL SIZE | PIPE SIZE | CAST IRON | | ABS | |
|-----------|-----------|-----------|-------|----------|-------|
| | | FIG. NO. | PRICE | FIG. NO. | PRICE |
| 3" | 1 | 36275 | - | - | - |
| 4" | 1 | 10718 | - | 28160 | - |
| 4" | 1 1/4 | 10720 | - | - | - |
| 4" | 2 | 25894 | - | - | - |
| 5" | 1 | 35693 | - | - | - |
| 5 5/8" | 1 | 10730 | - | - | - |
| 5 5/8" | 1 1/4 | 27370 | - | - | - |
| 6" | 1 | 10734 | - | 28161 | - |
| 6" | 1 1/4 | 10737 | - | 35697 | - |
| 6" | 2 | 22181 | - | - | - |
| 6 1/4" | 1 | 25201 | - | - | - |
| 8" | 1 | 25504 | - | - | - |
| 8" | 3 | 25446 | - | - | - |



WELL CAPS

PREMIUM WATERTIGHT CAP

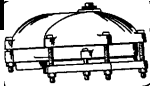

A truly watertight cap. The top of the cap can be removed without effecting the seal, conduit or wiring. Painted green and oven dried.

| ID Casing Size | Max Case OD | Conduit Tap Size | Vent Tap Size | FIG. NO. |
|----------------|-------------|------------------|---------------|----------|
| 4" | 4.545 | 1 1/2 | 1 | 30005 |
| 6" | 6.69 | 1 1/2 | 1 1/4 | 25296 |

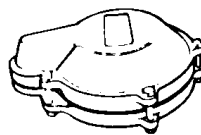

TURTLE WATERTIGHT CAP

A two piece cast iron cap that features an O-ring seal on the well. Top of the cap removes for easy well servicing. Standard series cap attaches to steel well casing with three square head bolts. Series cap for PVC casing attaches by solvent welding. Vermin resistant. Painted green and oven dried.

| DESCR | FIG. NO. | PRICE |
|-----------|----------|-------|
| Plastic | 52570 | |
| Cast Iron | 63299 | |

6" CAST IRON WELL CAP



1/4" grounding lug on ring meets national electric code requiring grounding of submersible pump.

| Nom Well Size | Casing OD | FIG. NO. | PRICE |
|---------------|-----------|----------|-------|
| 6&6 | 1/4 | 6-5/8 | 48536 |

ALUMINUM/ABS WELL CAP (low profile)

Constructed of injection-molded ABS plastic and aluminum. Cap base can be solvent welded directly to PVC well casing. 6-1/4" PVC.

| FIG. NO. | PRICE |
|----------|-------|
| 47616 | |



ALUMINUM WELL CAP

1/2" padlock locator holes to maintain well security.

| FIG. NO. | PRICE |
|----------|-------|
| 23803 | |

MULTI-SIZE SUBMERSIBLE WELL CAP



One size fits 5-5/8", 6", 6 1/4", heavy cast iron construction, Bright red for easy site location. Quick installation. Individually packaged.

| FIG. NO. | PRICE |
|----------|-------|
| 10753 | |

FOOT AND CHECK VALVES

BRASS CHECK VALVE

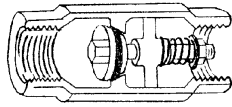

| SIZE | FIG. NO. | PRICE |
|-------|----------|-------|
| 1/2 | 10474 | |
| 3/4 | 10479 | |
| 1 | 10482 | |
| 1 1/4 | 10485 | |
| 1 1/2 | 10487 | |
| 2 | 10491 | |
| 2 1/2 | 10496 | |
| 3 | 10500 | |
| 4 | 10505 | |

BRASS FOOT VALVE

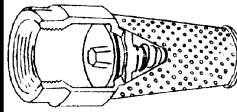

| SIZE | FIG. NO. | PRICE |
|-------|----------|-------|
| 1/2 | 10441 | |
| 3/4 | 10448 | |
| 1 | 10453 | |
| 1 1/4 | 10455 | |
| 1 1/2 | 10459 | |
| 2 | 10461 | |
| 2 1/2 | 10464 | |
| 3 | 10467 | |
| 4 | 10472 | |

CONTROLLER CHECK VALVE

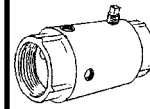

Eliminates the Tank Tee
With two and four tappings:
One for two 1/4" switch and gauge and two 1/8" snifter valve and 18" drain plug.

| TWO HOLE | | FOUR HOLE | |
|----------|----------|-----------|----------|
| SIZE | FIG. NO. | PRICE | FIG. NO. |
| 1 | 10527 | | 10514 |
| 1 1/4 | 10532 | | 10517 |
| 1 1/2 | | | 10524 |
| 2 | | | 10525 |

BRADY FOOT AND LINE CHECK VALVES

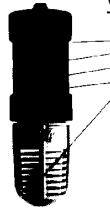

- 1) Nose Cone diffuser
- 2) Clapper
- 3) Sealing ring
- 4) Valve seat
- 5) Strainer (With strainer removed, any Brady Foot becomes a Line Check, which will operate in vertical, horizontal or inverted position)

MADE OF ABS PLASTIC

FOOT VALVES

CHECK VALVES

| SIZE | FIG. NO. | PRICE | FIG. NO. | PRICE |
|-------|----------|-------|----------|-------|
| 3/4 | 37652 | | 37653 | |
| 1 | 10677 | | 10699 | |
| 1 1/4 | 10681 | | 10710 | |
| 1 1/2 | 10685 | | 10715 | |

GALVANIZED FOOT VALVES

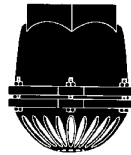

| SIZE | FIG. NO. | PRICE |
|-------|----------|-------|
| 1 1/4 | 10585 | |
| 1 1/2 | 10589 | |
| 2 | 10592 | |
| 2 1/2 | 10595 | |
| 3 | 10597 | |
| 4 | 10600 | |
| 5 | 10602 | |
| 6 | 10604 | |

GALVANIZED DRIVE COUPLING



| PIPE SIZE | FIG. NO. | PRICE |
|-----------|----------|-------|
| 1 1/4 | 18972 | |
| 1 1/2 | 18973 | |
| 2 | 18974 | |

4-FOR-1 FOOT VALVE



For jet pump, versatile; fits 3/4" through 1-1/4", Corrosion proof

MADE OF ABS PLASTIC

| FIG. NO. | PRICE |
|----------|-------|
| 23173 | |



PUMP BYPASS RELIEF VALVE. Recommended for unloading operating on oil, chemical, non-corrosive substances and water lines. Used for pump bypass relief, open tank discharge and pump closing relief. **CAUTION: SHOULD NOT BE USED AS EMERGENCY OR SAFETY RELIEF VALVE.**

Found in the following applications:
Water pump bypass, Irrigation, Sprinkler system on golf courses, Fountains, Fire protection systems
ADJUSTABLE 25-100 LB

WELL POINT

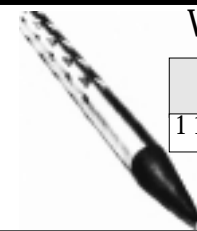

| SIZE | FIG. NO. | PRICE |
|----------|----------|-------|
| 1 1/4X24 | 17812 | |

CALL FOR OTHER SIZES!

PRESSURE RELIEF VALVE

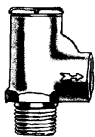

For pumps, tanks, etc.
* Set at 75 lbs.

100LB ALSO AVAILABLE!

| SIZE | FIG. NO. | PRICE |
|------|----------|-------|
| 1/2 | 10617 | |
| 3/4 | 10620 | |

| SIZE | FIG. NO. | PRICE |
|-------|----------|-------|
| 1/2 | 47308 | |
| 3/4 | 47310 | |
| 1 | 47312 | |
| 1 1/4 | 47314 | |
| 1 1/2 | 47316 | |
| 2 | 47318 | |
| 2 1/2 | 47320 | |
| 3 | 47322 | |

DRIVE CAP

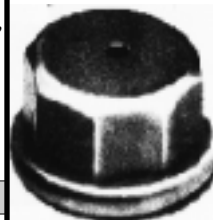

| FIG. NO. | PIPE SIZE | PRICE |
|----------|-----------|-------|
| 18975 | 1 1/4 | |
| 18976 | 1 1/2 | |
| 18977 | 2 | |

FLOMATIC ENVIRO CHECK UNLEADED VALVES



MODEL 80E ENVIRO-CHECK

Lead free bronze body
Threaded female x female connection
Non-spin acetal poppet
Stainless steel spring

| SIZE | FIG. NO. | PRICE |
|-------|----------|-------|
| 1/2 | 8538 | |
| 3/4 | 65317 | |
| 1 | 65208 | |
| 1 1/4 | 65318 | |
| 1 1/2 | 65319 | |
| 2 | 65209 | |
| 2 1/2 | 9133 | |
| 3 | 9134 | |
| 4 | 65320 | |

UNLEADED ENVIRO-CHECK FLOMATIC VALVES
The first lead-free bronze check valve, developed by Flomatic Corporation in order to protect potable water from lead contamination.

| Nominal Chemistry | |
|-------------------|------|
| Copper (Cu) | 88% |
| Tin (Sn) | 3.5% |
| Lead (Pb) | 0% |
| Zinc (Zn) | 7% |
| Nickel (Ni) | .5% |
| Bismuth | 1% |

*Lead free bronze alloy (Federally #1) less than 0.1% lead



MODEL 80BE ENVIRO-CHECK

Same as 80E with two drilled and tapped holes 1/8" inlet side and 1/4" outlet side

| SIZE | FIG. NO. | PRICE |
|-------|----------|-------|
| 1 | 65210 | |
| 1 1/4 | 9139 | |
| 1 1/2 | 39056 | |
| 2 | 39057 | |



MODEL 80XBE ENVIRO-CHECK

Same as 80E
With two 1/4" tapped holes on outlet side for pressure switch and gauge

| SIZE | FIG. NO. | PRICE |
|------|----------|-------|
| 1 | 65325 | |



MODEL 80CE ENVIRO-CHECK

Same as 80E
Control center for submersible pump installations with four tappings, one 1/8" inlet side, two 1/4" outlet side and one 1/8" outlet side with brass plug

| SIZE | FIG. NO. | PRICE |
|-------|----------|-------|
| 1 | 65321 | |
| 1 1/4 | 9163 | |
| 1 1/2 | 9145 | |
| 2 | 65322 | |



MODEL 80ME ENVIRO-CHECK

Submersible pump check valve
Lead free bronze (FEDRALLOY #1) body.

| SIZE | FIG. NO. | PRICE |
|------|----------|-------|
| 1 | 65324 | |



MODEL 100E Bronze In-Line Check Valve

Easy wrenching hex bronze body construction. High strength acetal poppet, stainless steel spring, Buna-N seal. 1".

| SIZE | FIG. NO. | PRICE |
|------|----------|-------|
| 1" | 33004 | |



MODEL 60s BRONZE FOOT
Cast bronze body
Threaded female connection
Features a NITRILE (Buna-N) seal
Acetal/bronze poppet, stainless spring and screen

| SIZE | FIG. NO. | PRICE |
|-------|----------|-------|
| 1/2 | 8413 | |
| 3/4 | 8435 | |
| 1 | 65311 | |
| 1 1/4 | 65312 | |
| 1 1/2 | 65313 | |
| 2 | 65314 | |
| 2 1/2 | 8509 | |
| 3 | 8522 | |
| 4 | 8529 | |

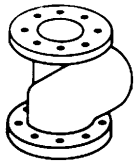

MODEL 50 BALL CHECK

Cast iron body threaded female x female connection. Corrosion resistant Phenolic

“sinking ball. Temp Max. 180 ° F Pressure Max. 150 PSI.

| SIZE | FIG. NO. | PRICE |
|-------|----------|-------|
| 1 | D172039 | |
| 1 1/4 | D172040 | |
| 1 1/2 | D172041 | |
| 2 | D172042 | |
| 2 1/2 | D172043 | |
| 3 | D172044 | |
| 4* | D172045 | |

*Flanged
Also available with “floating ball” for flood control or air vent (Model 50F)

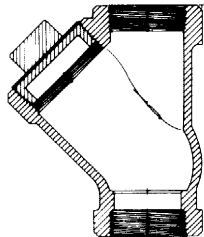

MODEL 208 BALL CHECK

Cast iron uni-body with clean-out port threaded female x female connection. Features NITRILE (Buna-N) “sinking ball”. Temp Max. 180 ° F Pressure Max. 150 PSI.

| SIZE | FIG. NO. | PRICE |
|-------|----------|-------|
| 1 1/4 | D172141 | |
| 2 | D172142 | |

CHECK VALVES

MODES 208T/208S PVC BALL CHECK

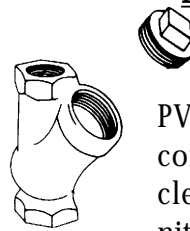

Corrosion resistant PVC body threaded female x female connection NITRILE (Buna-N) self-cleaning ball. EZ access port with nitrile seal. Temp. Max 180oF Pressure Max. 150 PSI.

| SIZE | FIG. NO. | PRICE |
|-------|----------|-------|
| 1 | D172131T | |
| 1 1/4 | D172132T | |
| 1 1/2 | D172133T | |
| 2 | D172134T | |

Also available with socket weld (slip). (Model 208S).

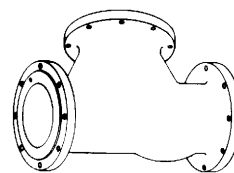

MODEL 408 BALL CHECK

Cast iron body and access port. Flanged connection ANSI 125 NITRILE (Buna-N) covered metal ball (sinking type), stainless fasteners

“Standard of the wastewater industry”. Temp Max. 180° F Pressure Max. 150 PSI.

| SIZE | FIG. NO. | PRICE |
|------|----------|-------|
| 3 | D172144 | |
| 4 | D172145 | |
| 5 | D172143 | |
| 6 | D172146 | |
| 8 | D172147 | |
| 10 | D172148 | |
| 12 | D172149 | |
| 14 | D172150 | |

Also available with “floating ball” for “anti-flooding” (Model 408F)

FAX YOUR ORDER!

610-279-6299

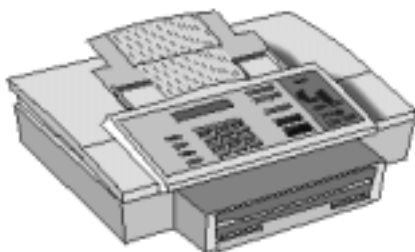



STAINLESS STEEL INSERT FITTINGS & VALVES

STAINLESS STEEL INSERT FITTINGS
ALL MACHINED FROM 316 ALLOY STAINLESS
STEEL PIPE

| | SIZE | FIG. NO. | PRICE |
|--|-------|----------|-------|
| MALE ADAPTER | | | |
|  | 1/2 | 50487 | |
| | 3/4 | MASS-3 | |
| | 1 | 48688 | |
| | 1 1/4 | MASS-5 | |
| | 1 1/2 | MASS-6 | |
| | 2 | MASS-8 | |

| | SIZE | FIG. NO. | PRICE |
|--|-------|----------|-------|
| EXTRA LONG MALE ADAPTER | | | |
|  | 1 | 37862 | |
| | 1 1/4 | 37863 | |

| | SIZE | FIG. NO. | PRICE |
|--|-----------|----------|-------|
| REDUCING MALE ADAPTER (MPTXINSERT) | | | |
|  | 1 1/4 X 1 | 62983 | |

| | SIZE | FIG. NO. | PRICE |
|--|-----------|----------|-------|
| EXTRA LONG REDUCING MALE ADAPTER (MPTXINSERT) | | | |
|  | 1 1/4 X 1 | RASS5-4 | |

| | SIZE | FIG. NO. | PRICE |
|--|-------|----------|-------|
| COUPLING | | | |
|  | 1 | CSS4 | |
| | 1 1/4 | CSS5 | |

| | SIZE | FIG. NO. | PRICE |
|--|-----------|----------|-------|
| HEX BUSHING (MPTXFPT) | | | |
|  | 1 1/4 X 1 | 6960 | |

STAINLESS STEEL VALVES

MODEL 100MSS ENVIRO-CHECK
303 Stainless Steel on piece body construction
High strength acetal poppet (optional Tefzel poppet for corrosive liquid available).
Stainless Steel spring, Buna-N seal. MALE X FEMALE.

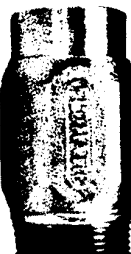

| SIZE | FIG. NO. | PRICE |
|--------------------|-----------|-------|
| 1/2" Mx 1/2" F | 47564 | |
| 3/4" Mx 3/4" F | 17-4218SS | |
| 1" Mx 1" F | 17-4220SS | |
| 1 1/4" x 1" F | 17-4221SS | |
| 1 1/4" Mx 1 1/4" F | 17-4242SS | |
| 1 1/2" Mx 1 1/2" F | 17-4232SS | |

STAINLESS STEEL WELL

SCREEN

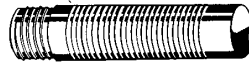

STAINLESS STEEL CASING TYPE 304 STAINLESS STEEL



| SIZE | FIG. NO. | PRICE |
|--------------|----------|-------|
| 1 1/4" X 5' | SSS0105 | |
| 1 1/4" X 10' | SSS0110 | |
| 2" X 5' | SSS0205 | |
| 2" X 10' | SSS0210 | |
| 4" X 5' | SSS0405 | |
| 4" X 10' | SSS0410 | |
| 5" X 5' | SSS0505 | |
| 5" X 10' | SSS0510 | |
| 6" X 5' | SSS0605 | |
| 6" X 10' | SSS0610 | |
| 8" X 5' | SSS0805 | |
| 8" X 10' | SSS0810 | |

| SIZE | FIG. NO. | PRICE |
|--------------|----------|-------|
| 1 1/4" X 5' | SSC0105 | |
| 1 1/4" X 10' | SSC0110 | |
| 2" X 5' | SSC0205 | |
| 2" X 10' | SSC0210 | |
| 4" X 5' | SSC0405 | |
| 4" X 10' | SSC0410 | |
| 5" X 5' | SSC0505 | |
| 5" X 10' | SSC0510 | |
| 6" X 5' | SSC0605 | |
| 6" X 10' | SSC0610 | |
| 8" X 5' | SSC0805 | |
| 8" X 10' | SSC0810 | |

Stainless points, threaded plugs, threaded caps and slip caps also available!

STAINLESS STEEL BAILERS

| SIZE | FIG. NO. | PRICE |
|--------------|----------|-------|
| 1 1/4" X 21" | SSB0121 | |
| 1 1/4" X 39" | SSB0139 | |
| 2" X 20" | SSB0220 | |
| 2" X 36" | 22B0236 | |



STAINLESS STEEL CHECK VALVE



304 Stainless Steel Body
304 Stainless Steel Poppet
Viton "O" Ring Seal (NITRILE Buna-N)
FEMALE X FEMALE

| SIZE | FIG. NO. | PRICE |
|--------|-----------|-------|
| 3/4" | 17CVSS75 | |
| 1" | 80358 | |
| 1 1/4" | 17CVSS125 | |
| 1 1/2" | 17CVSS150 | |
| 2" | 17CVSS200 | |
| 3" | 17CVSS300 | |
| 4" | 17CVSS400 | |

STAINLESS STEEL FOOT VALVE

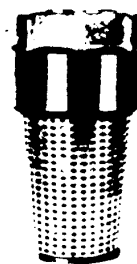

Stainless Steel Body and Poppet
Stainless Steel Screen
Viton "O" Ring Seal

| SIZE | FIG. NO. | PRICE |
|--------|-----------|-------|
| 1/2" | 17FVSS50 | |
| 3/4" | 17FVSS75 | |
| 1" | 17FVSS100 | |
| 1 1/4" | 17FVSS125 | |
| 1 1/2" | 17FVSS150 | |
| 2" | 17FVSS200 | |
| 3" | 17FVSS300 | |
| 4" | 17FVSS400 | |

MALE ADAPTER



| STEEL | | | BRASS | |
|-------|----------|-------|----------|-------|
| SIZE | FIG. NO. | PRICE | FIG. NO. | PRICE |
| 1/2 | 10887 | | 11203 | |
| 3/4 | 10892 | | 11205 | |
| 1 | 10897 | | 11208 | |
| 1 1/4 | 10906 | | 11210 | |
| 1 1/2 | 10917 | | 11212 | |
| 2 | 10923 | | 11214 | |
| 2 1/2 | 18301 | - | - | - |
| 3 | 20023 | - | - | - |
| 4 | 20024 | - | - | - |
| 6 | 20025 | - | - | - |

COUPLING



| STEEL | | | BRASS | |
|-------|----------|-------|----------|-------|
| SIZE | FIG. NO. | PRICE | FIG. NO. | PRICE |
| 1/2 | 11136 | | 11216 | |
| 3/4 | 11139 | | 11217 | |
| 1 | 11140 | | 11218 | |
| 1 1/4 | 11142 | | 11220 | |
| 1 1/2 | 11144 | | 11221 | |
| 2 | 11146 | | 11222 | |

VENTURI MALE ADAPTER



| STEEL | | | BRASS | |
|-----------|----------|-------|----------|-------|
| SIZE | FIG. NO. | PRICE | FIG. NO. | PRICE |
| 1 X 8 | 11175 | | 19644 | |
| 1 1/4 X 8 | 11176 | | 19645 | |

FOR INSERT FITTINGS AND POLY PIPE, PLEASE SEE PAGES 610-611

METAL INSERT FITTINGS

BRASS TEE



Fabricated

| SIZE | FIG. NO. | PRICE |
|---------|----------|-------|
| 3/4 | | |
| 1 | | |
| 1X3/4 | | |
| 1 1/4 | | |
| 1 1/4X1 | | |
| 1 1/2 | | |

AVAILABLE BY SPECIAL ORDER

ONE PIECE ELL



Brass

| SIZE | FIG. NO. | PRICE |
|-------|----------|-------|
| 3/4 | 23524 | |
| 1 | 23525 | |
| 1 1/4 | 22462 | |
| 1 1/2 | 23526 | |

FEMALE ADAPTER



| STEEL | | | BRASS | |
|-------|----------|-------|----------|-------|
| SIZE | FIG. NO. | PRICE | FIG. NO. | PRICE |
| 1/2 | 11181 | | 11224 | |
| 3/4 | 11183 | | 11225 | |
| 1 | 11185 | | 11227 | |
| 1 1/4 | 11187 | | 11229 | |
| 1 1/2 | 11189 | | 11231 | |
| 2 | 11190 | | 11232 | |

EXTRA LONG COUPLING



| STEEL | | | BRASS | |
|-------|----------|-------|----------|-------|
| SIZE | FIG. NO. | PRICE | FIG. NO. | PRICE |
| 1 | 35845 | | 33203 | |

EXTRALONG ADAPTER



| Size | Fig. No. | Price |
|--------------|----------|-------|
| BRASS | | |
| 1 | 11246 | |
| 1 1/4 | 11247 | |
| STEEL | | |
| 1 | 11241 | |
| 1 1/4 | 11243 | |

CAST ROPE ADAPTER

Brass



| SIZE | FIG. NO. | PRICE |
|------|----------|-------|
| 1 | 18149 | |

REDUCING ADAPTER



Brass

| SIZE | FIG. NO. | PRICE |
|-----------|----------|-------|
| 1 X 3/4 | 47415 | - |
| 1 1/4 X 1 | 11251 | |

WELL SEAL ELLS



| Insert X Insert | | |
|-----------------|----------|-------|
| SIZE | FIG. NO. | PRICE |
| 1 | 11194 | |
| 1 1/4 | 11196 | |
| Insert X Male | | |
| SIZE | FIG. NO. | PRICE |
| 1 | 34097 | |
| 1 1/4 | 11197 | |

WE'RE WAITING FOR YOUR CALL!

610-275-4453

PUMP ACCESSORIES

BRADY



NON-REPAIRABLE

| FIG. NO. | TANK CAP | TANK CONN | PUMP CONN | PRICE |
|----------|----------|-----------|------------|-------|
| 10758 | 45 | 1/4 MPT | 1/4 M COMP | |
| 10770 | 80 | 1/4 MPT | 1/8 FIP | |
| 10761 | 120 | 3/8 MPT | 1/4 M COMP | |
| 10764 | 120 | 3/8 MPT | 1/8 FIT | |

PIPE WRAP TAPE



General purpose vinyl plastic tape

3M TEMFLEX. 2" wide x 100'

Temperature range = -10°C/+80°C

| DESCR | FIG. NO. | PRICE |
|--------|----------|-------|
| 10 MIL | 82344 | |

TYPE ALL PLASTIC DEEP WELL AIR RELEASE

Maintains proper ratio of air to water in submersible water systems. All polyethylene construction, including float, will not corrode - includes gauge port and 0-40 lb. limited bleed adjustment



| FIG. NO. | PRICE |
|----------|-------|
| 32856 | |

DEEP WELL AIR RELEASE

Maintains proper ratio of air to water in submersible water systems. Deluxe deep well air release features ABS float and cast body which prevents galvanic action and pump tapping.



| FIG. NO. | PRICE |
|----------|-------|
| 10776 | |

AIR VOLUME CONTROL TYPE

Type "L" Preserves correct proportion of water and air in shallow well reciprocating pump systems. Includes tubing and fittings.

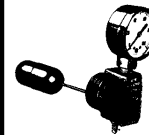

| FIG. NO. | PRICE |
|----------|-------|
| 10782 | |

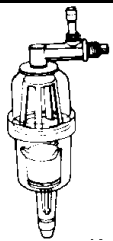

JACUZZI JET CHARGER

This automatic jet charger is an effective device for maintaining the proper air charge in a pressure tank. It is suitable for use with deep and shallow well jet pumps, and on centrifugal and booster installations. Series 225A automatic jet charger is designed for maximum working pressure of 75 psig and is not recommended for tanks larger than 120 gallons.

| FIG. NO. | PRICE |
|----------|-------|
| 10798 | |

BACK CONNECTION PRESSURE GAUGE



| SIZE | FIG. NO. | PRICE |
|------|----------|-------|
| 1/8 | 10614 | |

PUMP PRESSURE GAUGE

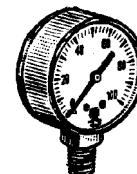

*All brass and bronze movement
 *Eliminates sticking and hanging up
 *Easier to read
 2" Dial 1/4" x 100 lb.

| FIG. NO. | PRICE |
|----------|-------|
| 10610 | |



TANK CROSSES

**LONG TANK
CROSS-CAST**



| FIG. NO. | LENGTH | OUTSIDE | INSIDE | TOP | FRONT | PRICE |
|----------|--------|---------|--------|------|-------|-------|
| 10548 | 10" | 1X1X1 | 3/4" | 1/4" | 1/2" | |

**LONG TANK
CROSS-FABRICATED**



| FIG. NO. | LENGTH | OUTSIDE | INSIDE | TOP | FRONT | PRICE |
|----------|--------|-------------------|--------|------|-------|-------|
| 25884 | 13" | 1X1X1 | 3/4" | 1/4" | 1/2" | |
| 10561 | 16" | 1 1/4X1 1/4X1 1/4 | 1" | 1/4" | 1/2" | |

WELL-X-TROL TANKS ARE
AVAILABLE IN SIZES UP TO
528 GALLONS IN VOLUME

CALL FOR ASME RATED TANKS

SHORT TANK CROSS

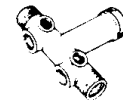

| FIG. NO. | SIZE | PRICE |
|---------------|-----------|-------|
| (Brass) 10577 | 1X3/4X3/4 | |
| (Brass) 33936 | 1 1/4X1X1 | |

**PUMP OR TANK
PROBLEM?**

CALL DUFF!

**WE HAVE THE
SOLUTION!**

610-275-4453

SELECTION TABLE - WELL-X-TROL

| OLD-STYLE PRES- SURE TANK SIZE (volume in gallons) | WELL-X-TROL MODEL NO. | PRESSURE SWITCH | |
|--|--------------------------|---|----------------------------|
| | | WELL-X-TROL PRE- CHARGE PUMP CUT- IN PRESSURE | PUMP CUT-OUT PRES- SURE |
| 6 | WX-101 | 20 PSI | 40 PSI |
| 12 | WX-102 | 20 PSI | 40 PSI |
| 20 | WX-103 | 30 PSI | 50 PSI |
| 30 | WX-200 | 30 PSI | 50 PSI |
| 30 | WX-201 | 30 PSI | 50 PSI |
| 42 | WX-202 | 30 PSI | 50 PSI |
| 82 | WX-203 | 30 PSI | 50 PSI |
| 120 | WX-250 | 30 PSI | 50 PSI |
| 225 | WX-302 | 25 PSI | 50PSI |

PUMP STAND

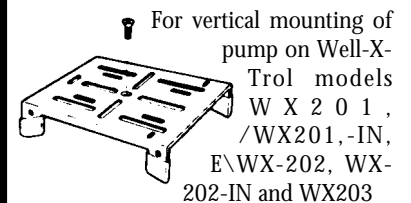

| FIG. NO. | PRICE |
|----------|-------|
| 10833 | |

Vertical mounting of pump on Well-X-Trol models WX-250, WX-251 and WX-252.

| FIG. NO. | PRICE |
|----------|-------|
| 44484 | |

RESIDENTIAL WELL-X-TROL TANKS

IN-LINE MODELS



| MODEL NO. | DIMENSIONS | | TOTAL VOLUME (GALS) | DRAWDOWN | | | SHIP WT (VOL LBS (CUFT)) | FIG. NO | PRICE |
|-----------|------------|--------------|---------------------|--------------|--------------|--------------|--------------------------|---------|-------|
| | DIA (INS) | HEIGHT (INS) | | 20/40 (GALS) | 30/50 (GALS) | 40/60 (GALS) | | | |
| WX-101 | 8 | 12 5/8 | 2.0 | .8 | .6 | .5 | 5 (0.6) | 7764 | |
| WX-102 | 11 | 15 | 4.4 | 1.6 | 1.4 | 1.2 | 9 (1.2) | 7768 | |
| WX-103 | 11 | 24 3/4 | 8.6 | 3.1 | 2.7 | 2.2 | 15 (2.0) | 7771 | |
| WX-104 | 15 3/8 | 17 3/8 | 10.3 | 3.8 | 3.2 | 2.8 | 20 (2.6) | 7774 | |
| WX-200 | 15 3/8 | 22 | 14.0 | 5.2 | 4.3 | 3.8 | 25 (3.3) | 7780 | |



Precharge Pressure for WX-101 & WX-102 is 20 PSIG and Sys. Conn. is 3/4" NPTM.
 Precharge Pressure for WX-103 is 30 PSIG and Sys. conn. is 3/4" NPTM.
 Precharge Pressure for WX-104 and EX-200 is 30 PSIG and Sys.Conn. is 1" NPTM.
 Maximum Working Pressure is 100 PSIG and Maximum Working Temperature is 200°F.

STAND MODELS

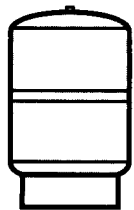

| MODEL NO. | DIMENSIONS | | TOTAL VOLUME (GALS) | DRAWDOWN | | | SHIP WT (VOL LBS (CUFT)) | FIG. NO | PRICE |
|-----------|------------|--------------|---------------------|--------------|--------------|--------------|--------------------------|---------|-------|
| | DIA (INS) | HEIGHT (INS) | | 20/40 (GALS) | 30/50 (GALS) | 40/60 (GALS) | | | |
| WX-104-S | 15 3/8 | 19 1/4 | 10.3 | 3.8 | 3.2 | 2.8 | 25 (3.0) | 7777 | |
| WX-201 | 15 3/8 | 23 7/8 | 14.0 | 5.1 | 4.3 | 3.7 | 27 (3.8) | 7781 | |
| WX-202 | 15 3/8 | 31 5/8 | 20.0 | 7.3 | 6.2 | 5.4 | 35 (4.9) | 7784 | |
| WX-203 | 15 3/8 | 46 3/8 | 32.0 | - | 9.9 | 8.6 | 43 (7.0) | 7786 | |
| WX-205 | 22 | 29 1/2 | 34.0 | 12.4 | 10.5 | 9.1 | 61 (9.5) | 43262 | |
| WX-250 | 22 | 35 5/8 | 44.0 | 16.3 | 13.6 | 11.9 | 69 (11.0) | 7789 | |
| WX-251 | 22 | 46 3/4 | 62.0 | 22.9 | 19.2 | 16.7 | 92 (13.9) | 46830 | |
| WX-302 | 26 | 47 3/16 | 86.0 | 31.8 | 26.7 | 23.2 | 123 (18.9) | 29811 | |
| WX-350 | 26 | 61 7/8 | 119.0 | 44.0 | 36.9 | 32.1 | 166 (24.5) | 30032 | |



UNDERGROUND MODELS

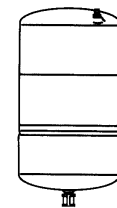

| MODEL NO. | DIMENSIONS | | TOTAL VOLUME (GALS) | DRAWDOWN | | | SHIP WT (VOL LBS (CUFT)) | FIG. NO | PRICE |
|-----------|------------|--------------|---------------------|--------------|--------------|--------------|--------------------------|---------|-------|
| | DIA (INS) | HEIGHT (INS) | | 20/40 (GALS) | 30/50 (GALS) | 40/60 (GALS) | | | |
| WX1250-UG | 22 | 33 3/8 | 44.0 | 16.3 | 13.6 | 11.9 | 63 (11.0) | 59993 | |
| WX251-UG | 22 | 44 1/2 | 62.0 | 22.9 | 19.2 | 16.7 | 83 (13.9) | 76587 | |

Precharge Pressure for Models 200-UG and 202-UG is 30 PSIG ans Sys. conn. is 1" NPTF Coupling.
 Precharge Pressure for Models 250-UG and 251-UG is 38 PSIG; Sys. Conn is 1 1/4" NPTF Coupling.
 Maximum Working Pressure is 100 PSIG and Maximum Working Temperature is 200°F.



PUMP STAND MODELS



| MODEL NO. | DIMENSIONS | | TOTAL VOLUME (GALS) | DRAWDOWN | | | SHIP WT (VOL LBS (CUFT)) | FIG. NO | PRICE |
|-----------|------------|--------------|---------------------|--------------|--------------|--------------|--------------------------|---------|-------|
| | DIA (INS) | HEIGHT (INS) | | 20/40 (GALS) | 30/50 (GALS) | 40/60 (GALS) | | | |
| WX-200-PS | 17 1/4 | 15 5/8 | 14.0 | 5.2 | 4.3 | 3.8 | 29 (4.0) | 41013 | |

Precharge Pressure is 30 PSIG ans Sys. conn. is 1" NPTF Coupling.
 Maximum Working Pressure is 100 PSIG and Maximum Working Temperature is 200°F.



OFFSET CONNECTOR MODELS

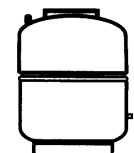

| MODEL NO. | DIMENSIONS | | TOTAL VOLUME (GALS) | DRAWDOWN | | | SHIP WT (VOL LBS (CUFT)) | FIG. NO | PRICE |
|-----------|------------|--------------|---------------------|--------------|--------------|--------------|--------------------------|---------|-------|
| | DIA (INS) | HEIGHT (INS) | | 20/40 (GALS) | 30/50 (GALS) | 40/60 (GALS) | | | |
| WX-201-OC | 15 3/8 | 24 5/8 | 14.0 | 5.1 | 4.3 | 3.8 | 25 (3.8) | 19812 | |



GALVANIZED PUMP TANKS

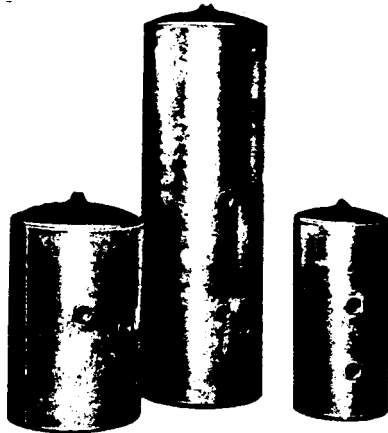

RETENTION TANKS

| FIG. NO. | 75# WORKING PRESSURE | | | | 150# | |
|----------|---------------------------|-------------------|------------------|-------------|----------|-------|
| | Capacity (actual gallons) | Diameter (inside) | Length (overall) | Weight Lbs. | FIG. NO. | PRICE |
| 25514 | 30 | 16 | 38 | 56 | | |
| 7854 | 42T | 16 | 50 | 67 | 7869 | |
| 7858 | 42S | 20 | 35 | 75 | 35044 | |
| 7861 | 80 | 20 | 63 | 115 | 45438 | |
| 7864 | 120 | 24 | 63 | 195 | | |
| 23340 | 220 | 30 | 73 | 290 | | |
| 42884 | 310 | 36 | 74 | 390 | | |
| 42885 | 530 | 36 | 124 | 535 | | |

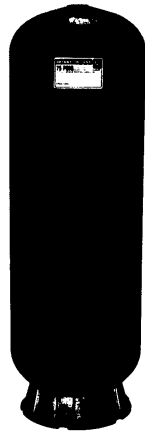

STRUCTURAL Fiberglass Retention Tanks

Safe for the environment (No lead or other metals)
 Resists chemical attack and corrosion
 Seamless, uniform inner shell made of NSF listed polyethylene
 No tank coatings needed
 Same high strength steel, with about half the weight
 Easy to handle and install
 75 psig operating pressure
 1 1/4" NPT connection on top and bottom (custom openings also offered).
 Five year warranty from date of manufacture.

| FIG. NO. | Capacity (gallon/litre) | Height (inches) | Diameter (inches) | PRICE |
|----------|-------------------------|-----------------|-------------------|-------|
| 47942 | 80 | 67 | 21 | |
| 47943 | 120 | 73 | 24 | |

GLASS LINED RETENTION TANKS

| | | | | |
|-------|--------|--|--|--|
| 50798 | RT42T | | | |
| 50799 | RT80T | | | |
| 50800 | FT120T | | | |

Epoxy Coated Retention tanks

Baked on finish Epoxy coat inside Oven baked outside

Typical Installation w/Chemical Feed Pump

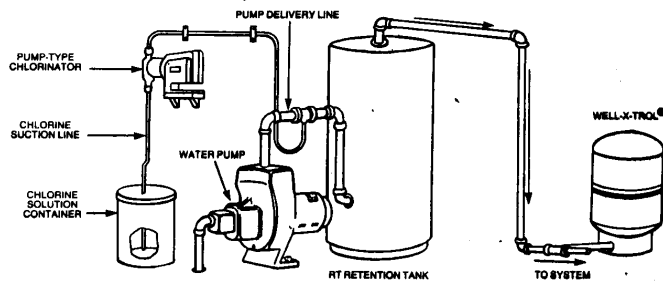

| FIG. NO. | Capacity (gallon) | Size (D" X H") | Approx. weight, Lbs. | PRICE |
|----------|-------------------|----------------|----------------------|-------|
| 50799 | 80 | 20x64 | 84 | |
| 50800 | 120 | 24x66 | 139 | |

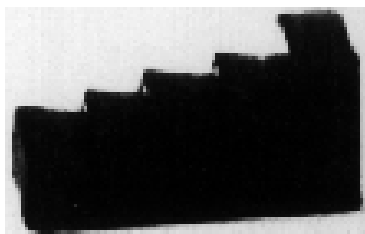

TANK LEGS

Elevates tank above floor
 Levelled on uneven floors

| FIG. NO. | PRICE |
|----------|-------|
| 10574 | |



DUFF CO.

PUMPS

STANDARD SCH 40 PVC WELL SCREENS WITH MALE X FEMALE FLUSH THREAD

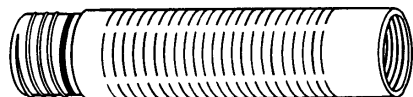

| SIZE | .010 SLOT | PRICE | .020 SLOT | PRICE |
|-----------|--------------|-------|--------------|-------|
| 2"x2 1/2' | 48672 | | 48679 | |
| 2"x5' | 48673 | | 48680 | |
| 2"x10' | 48674 | | 17811 | |
| 2"x20' | 48675 | | 48681 | |
| 4"x2 1/2' | 48676 | | 48685 | |
| 4"x5' | 48677 | | 43652 | |
| 4"x10' | 17810 | | 21261 | |
| 4"x20' | 48678 | | 48682 | |

STANDARD SCH 40 PVC CASING WITH MALE X FEMALE FLUSH THREAD (NON-SLOTTED)

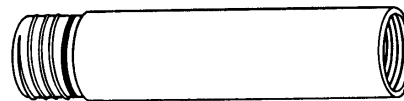

| SIZE | FIG. NO. | PRICE |
|-----------|----------|-------|
| 2"x2 1/2' | 30196 | |
| 2"x5' | 30327 | |
| 2"x10' | 48669 | |
| 2"x20' | 48670 | |
| 4"x2 1/2' | 21266 | |
| 4"x5' | 21264 | |
| 4"x10' | 21267 | |
| 4"x20' | 48671 | |

STANDARD SCH 40 PVC WELL SCREEN PLAIN ENDS (NON-THREADED)

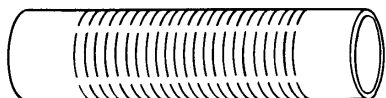

| SIZE | .016 SLOT | PRICE | .010 SLOT | PRICE | .020 SLOT | PRICE |
|------|--------------|-------|--------------|-------|--------------|-------|
| 2x10 | 52584 | - | - | - | - | - |
| 4x10 | - | - | 51609 | - | 51610 | - |

PVC FLUSH JOINT PLUGS



| SIZE | FIG. NO. | PRICE |
|------|----------|-------|
| 2" | 30197 | |
| 4" | 21262 | |

PVC FLUSH JOINT CAPS



| SIZE | FIG. NO. | PRICE |
|------|----------|-------|
| 2" | 30195 | |
| 4" | 21263 | |

CLEAR PVC BAILERS



| SIZE | FIG. NO. | PRICE |
|-----------|----------|-------|
| 11/4"x15" | PVCV215 | |
| 11/4"x36" | PVCB236 | |
| 11/4"x48" | PVCB248 | |



PURE GOLD BENTONITE

| DESCR | FIG. NO. | PRICE |
|--------------------------|----------|-------|
| 5 Gallon Pail | 48683 | |
| 3/8 tablets | | |
| 50 LB bag chips | 48684 | |
| 50 LB bag one step grout | 25041 | |

MONITORING WELL MANHOLE



12 X 12 flush Mount Monitoring Well Manhole. The 8" EWP Manhole is intended to be used as an access port for monitoring well installed in a driveway. It is designed to help protect the well from any unauthorized access.

The Cover has the words "monitoring well" cast into it in large letters. Two bolts hold the cover tightly to the rim making it accessible only with a wrench. A Guna-N gasket prevents surface water or product from entering the contaminating the well. Inside diameter will accommodate up to a 4" well plug.

| SIZE | FIG. NO. | PRICE |
|-------|----------|-------|
| 12X12 | 53406 | |
| 8X12 | 48686 | |



ENVIRONMENTAL

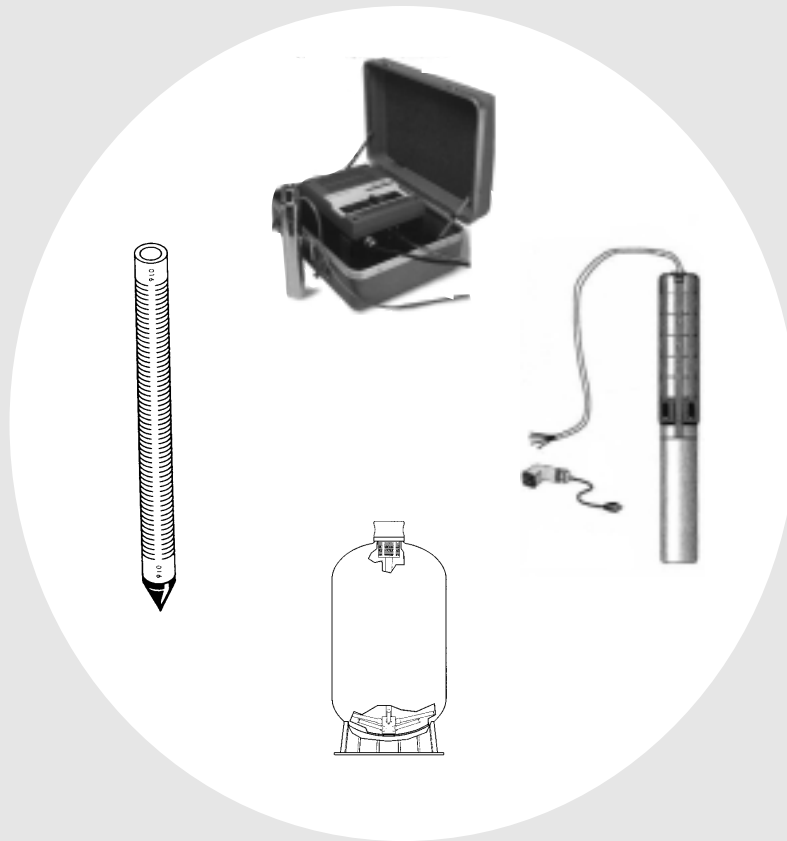

ENVIRONMENTAL

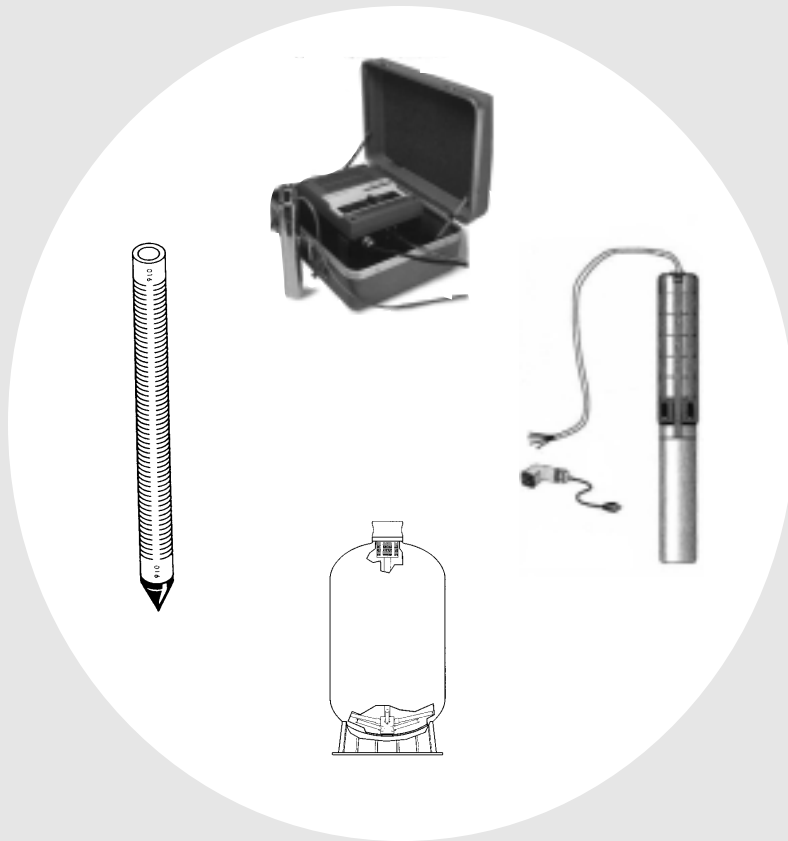



Redi-Flo

Redi-Flo Pumping Systems



**The Optimal Pumping Solution for Sampling and
Remediating Contaminated Groundwater**



GRUNDFOS



Leaders in Pump Technology

Redi-Flo...the industry's choice for environmental applications

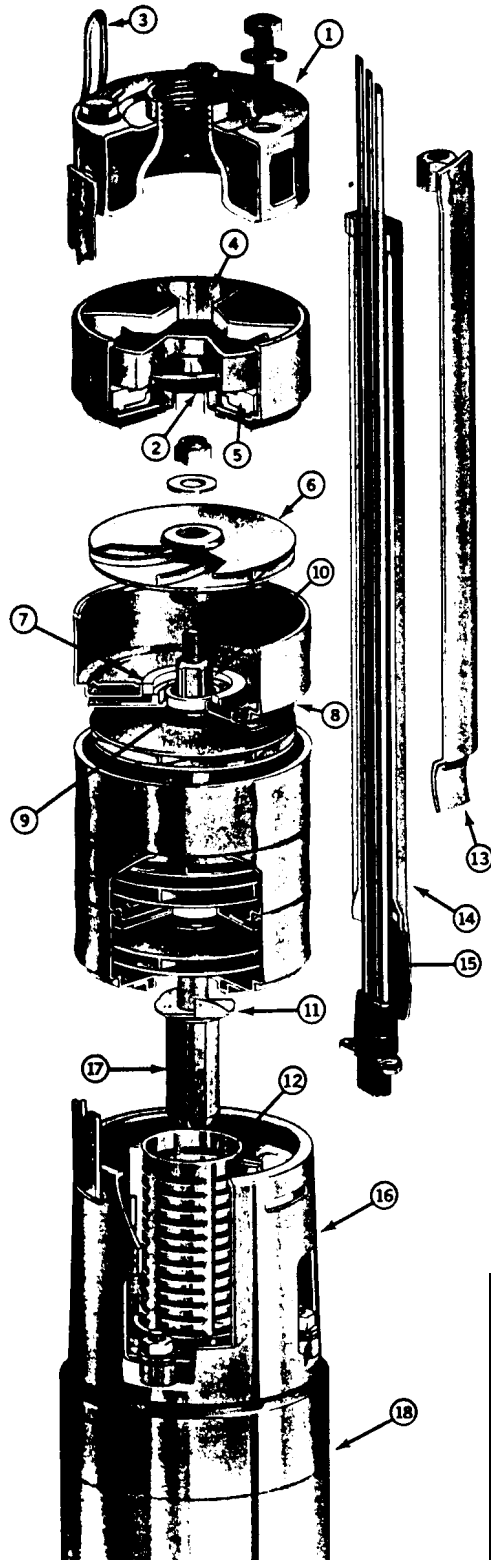

Environmental Engineers Specify the Pump they've Relied on for Years...GRUNDFOS

Environmental engineers specify GRUNDFOS' stainless steel and Teflon® submersible as the industry's number one choice. The importance of stainless steel and Teflon® has long been recognized and endorsed by government agencies as the accepted materials for ensuring sample integrity. With the possibility of corroded equipment producing false readings, con-

tamination-free equipment is an important safeguard against sample bias.

GRUNDFOS stainless steel and Teflon® Redi-Flo submersibles meet or exceed governmental guidelines for environmental equipment. And over time, through dedication and consistent quality, are proving to be the industry's choice in contamination-free submersible pumps.

Typical Applications Include Well Purging and Water Table Depression

Redi-Flo pumps are designed for reliable operation in a wide variety of applications and toxic environments. Applications include well purging, water table depression, and many other applications requiring contamination-free equipment.

Well purging eliminates contaminants to ensure that samples collected in monitoring wells are representative of the surrounding aquifer. It is very important to use stainless steel and Teflon® non-corrosive pumps to ensure accurate samples. The Redi-Flo submersible is designed for this need.

Another typical application is water table depression. With proper placement of the

recovery well and proper sizing of the depression pump, the movement of the hydrocarbon contamination plume can be stopped and/or reversed. After being isolated, the contaminant can be removed for treatment, re-use, or proper disposal.

Experienced GRUNDFOS engineers are on call to provide assistance in the selection and proper use of GRUNDFOS environmental pumps. The corporate commitment to quality and the durable, corrosion-resistant components make GRUNDFOS Redi-Flo pumps the optimum choice for environmental applications.

Materials of Construction

- | | |
|---|--|
| 1. Stainless Steel Discharge | 10. Stainless Steel Splined Shaft |
| 2. Stainless Steel Check Valve | 11. Stainless Steel Priming Inducer |
| 3. Stainless Steel Safety Cable Connector | 12. Stainless Steel Slotted Inlet Screen |
| 4. Stainless Steel Check Valve Retainer | 13. Stainless Steel Straps |
| 5. Teflon® Check Valve Seat | 14. Stainless Steel Motor Cable Guard |
| 6. Stainless Steel Impeller | 15. Teflon® Motor Cable |
| 7. Teflon® Impeller Seal Ring | 16. Stainless Steel Suction Interconnector |
| 8. Stainless Steel Chambers and Guide Vanes | 17. Stainless Steel Shaft Coupling |
| 9. Teflon® Intermediate Bearings | 18. Stainless Steel and Viton Motor |

GRUNDFOS 

**CALL DUFF NOW FOR
MORE
INFORMATION!
610-275-4453**

GRUNDFOS REDI-FLO4

| 5E PUMP TYPE | MOTOR | | | | DIMENSIONS (IN INCHES) | | | | | | NET WGHT (LBS) ** | SHIP WGHT (LBS) ** |
|--------------------|-------|------|----|-------|------------------------|---------------|---------------------|--------------|---------|----------------------------------|----------------------------|-----------------------------|
| | HP | SF | PH | VOLTS | OVRL LNTH | MOTOR LNTH | PUMP END LNTH | MAX. DIA. | INLET | DISCH PIPE SIZE (NPT) F | | |
| | | | | | A | B* | C | D | E | F | | |
| 5E3 | 1/3 | 1.75 | 1 | 230 | 18 9/16 | 40 5/16 | 10 | 13 9/6 | 8 9/16 | 3 31/32 | 3 1/4 | 1 |
| 5E5 | 1/3 | 1.75 | 1 | 230 | 20 5/16 | | 10 | | 10 5/16 | 3 31/32 | 3 1/4 | 1 |
| 5E8 | 1/3 | 1.75 | 1 | 230 | 22 3/4 | | 10 | | 12 3/4 | 3 31/32 | 3 1/4 | 1 |
| 5E12 | 1/2 | 1.60 | 1 | 230 | 26 | | 10 | | 16 | 3 31/32 | 3 1/4 | 1 |
| 5E17 | 3/4 | 1.50 | 1 | 230 | 13/16 | | 13/16 | | 20 3/16 | 3 31/32 | 3 1/4 | 1 |
| 5E21 | 1 | 1.40 | 1 | 230 | 31 7/16 | | 11 3/8 | | 23 7/16 | 3 31/32 | 3 1/4 | 1 |
| 5E25 | 1 1/2 | 1.30 | 1 | 230 | 35 7/16 | | 12 | | 26 3/4 | 3 31/32 | 3 1/4 | 1 |
| 10E | | | | | | | | | | | | |
| 10E5 | 1/3 | 1.75 | 1 | 230 | 20 5/16 | 35 3/8 | 10 | 13 9/16 | 10 5/16 | 21 | 3 31/32 | 3 1/4 |
| 10E8 | 1/2 | 1.60 | 1 | 230 | 23 9/16 | | 10 | | 12 3/4 | 13/16 | 3 31/32 | 3 1/4 |
| 10E11 | 3/4 | 1.50 | 1 | 230 | 26 9/16 | | 13/16 | | 15 3/16 | 3 31/32 | | 3 1/4 |
| 10E14 | 1 | 1.40 | 1 | 230 | 29 | | 11 3/8 | | 17 | 3 31/32 | | 3 1/4 |
| 10E19 | 1 1/2 | 1.30 | 1 | 230 | 11/16 | | 12 | | 11/16 | 3 31/32 | | 3 1/4 |
| 16E | | | | | | | | | | | | |
| 16E4 | 1/2 | 1.60 | 1 | 230 | 20 1/4 | 10 | 13 9/16 | 9 7/16 | 3 31/32 | 3 1/4 | 1 1/4 | 25 |
| 16E7 | 3/4 | 1.50 | 1 | 230 | 23 1/4 | 13/16 | | 11 7/8 | 3 31/32 | 3 1/4 | 1 1/4 | 27 |
| 16E9 | 1 | 1.40 | 1 | 230 | 25 9/16 | 11 3/8 | | 13 9/16 | 3 31/32 | 3 1/4 | 1 1/4 | 28 |
| 16E13 | 1 1/2 | 1.30 | 1 | 230 | 30 7/16 | 12 | | 16 7/8 | 3 31/32 | 3 1/4 | 1 1/4 | 33 |
| 25E | | | | | | | | | | | | |
| 25E3 | 1/2 | 1.60 | 1 | 230 | 19 3/8 | 26 5/16 | 10 | 13 9/16 | 8 9/16 | 3 31/32 | 3 1/4 | 1 1/2 |
| 25E4 | 3/4 | 1.50 | 1 | 230 | 20 | | 13/16 | | 9 7/16 | 3 31/32 | 3 1/4 | 1 1/2 |
| 25E16 | 1 | 1.40 | 1 | 230 | 13/16 | | 11 3/8 | | 11 1/16 | 3 31/32 | 3 1/4 | 1 1/2 |
| 25E18 | 1 1/2 | 1.30 | 1 | 230 | 23 1/16 | | 12 | | 21 3/4 | 3 31/32 | 3 1/4 | 1 1/2 |

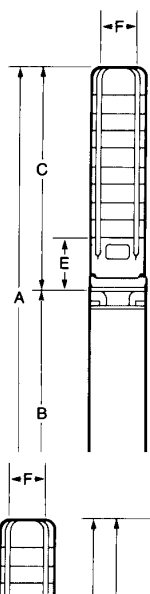

1. You must specify voltage, phase, and whether you want to operate with a control box (3 wire) or without (2 wire).

2. Any other Grundfos submersible pump or motor can be retrofitted with Teflon trim for environmental use.

*Data for Grundfos MS402E motors. **Does not include motor leads.

GRUNDFOS REDI-FLO4 PERFORMANCE CURVES

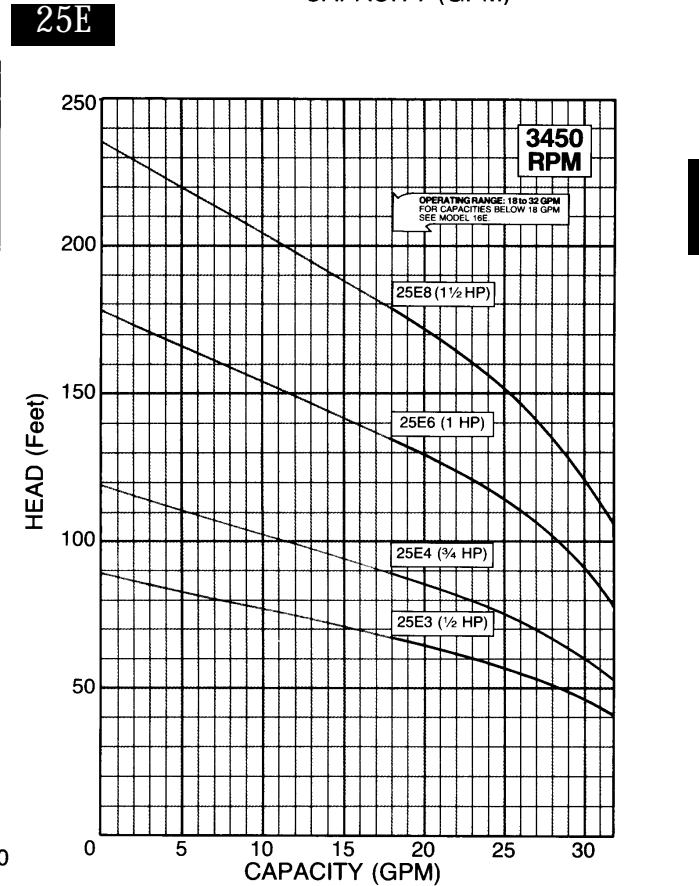
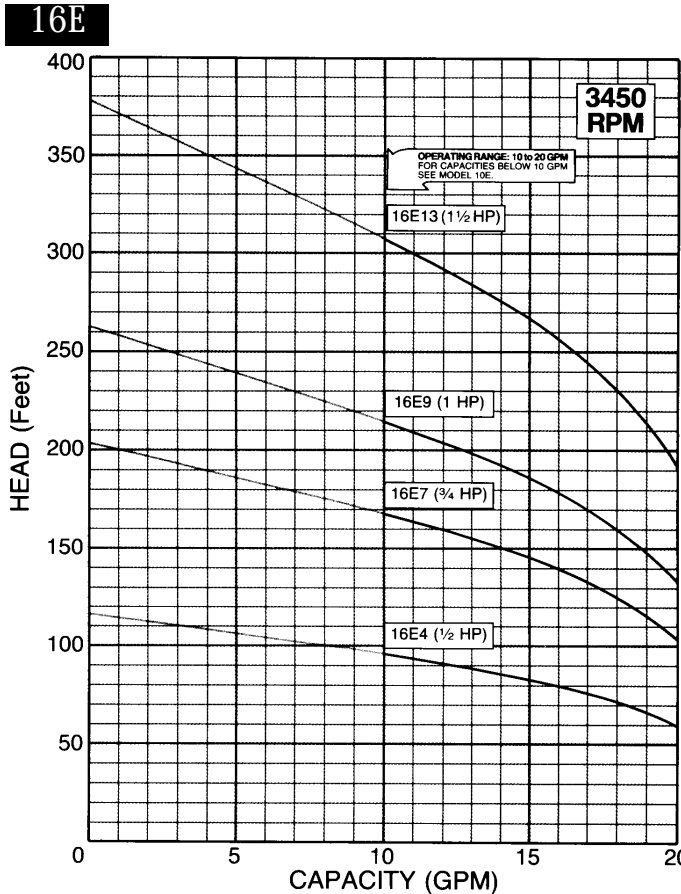
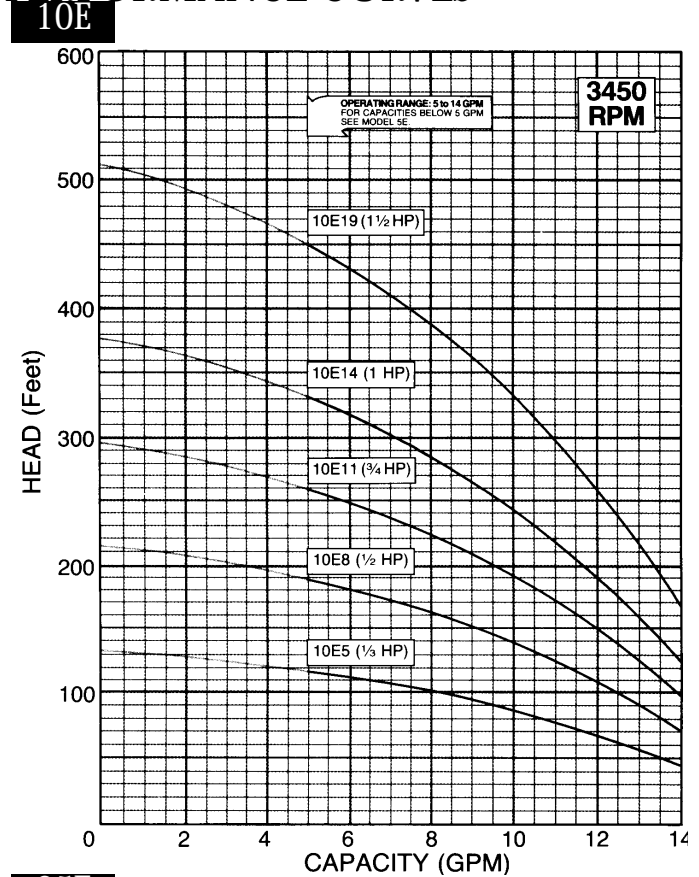
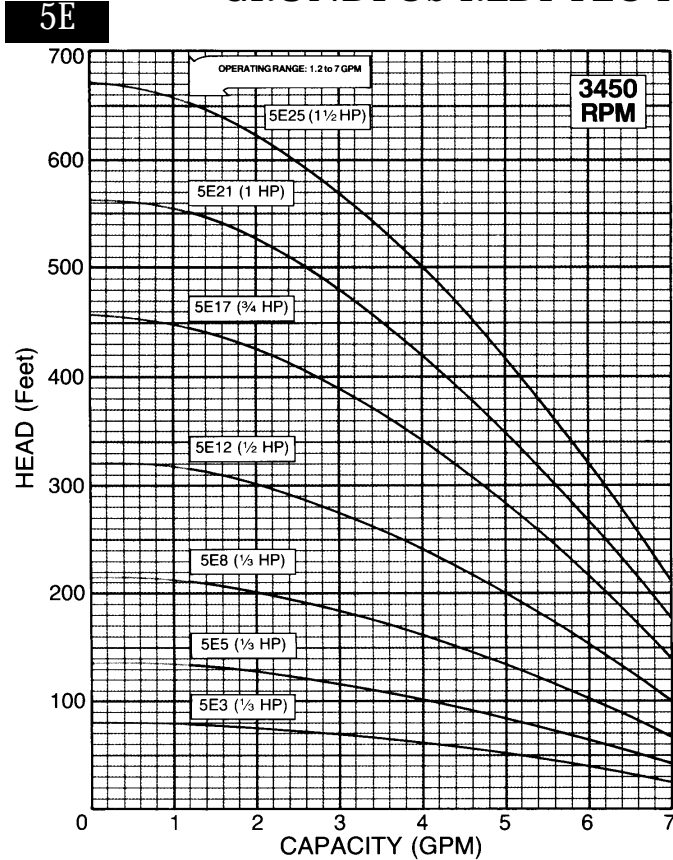

THE COMPLETE PURGE & SAMPLE SYSTEM

ONLY FROM GRUNDFOS

COMPACT DESIGN

No other pump on the market combines the compact design and power of Red-Flo2. measuring just over 11" tall, 1.8" in diameter and weighing 5.5 pounds, this compact pump ensures easy access into 2" wells.

QUALITY CONSTRUCTION

The sturdy pumping components of Red-Flo2 are made of 316 Stainless Steel and virgin Teflon. These chemically inert materials assure maximum sample integrity, limit cross-contamination, and simplify the decontaminations process.

FLEXIBLE PERFORMANCE

The potable, solid state converter eliminates the need for "throttling" or control valves.

CONTINUOUS FLOW

Redi-Flo2 is ideal for ground water sampling or conducting aquifer tests to depths of 250 feet because of its smooth, uninterrupted flow. Flow rates ranging from 9 gpm to as little as 100 ml/min are controlled with the simple turn of a dial.

PURGING AND SAMPLING

This pump does it all! The ingenious design of Red-Flo2 make it a natural for groundwater purging and sampling. Both high flow rates needed for purging and low flows recommended for sampling are achieved with the same pump!

DEDICATED OR PORTABLE INSTALLATIONS

Redi-Flo2 is designed for both dedicated and non-dedicated sampling installations. By attaching the pump to a reel of tubing, it becomes fully portable.

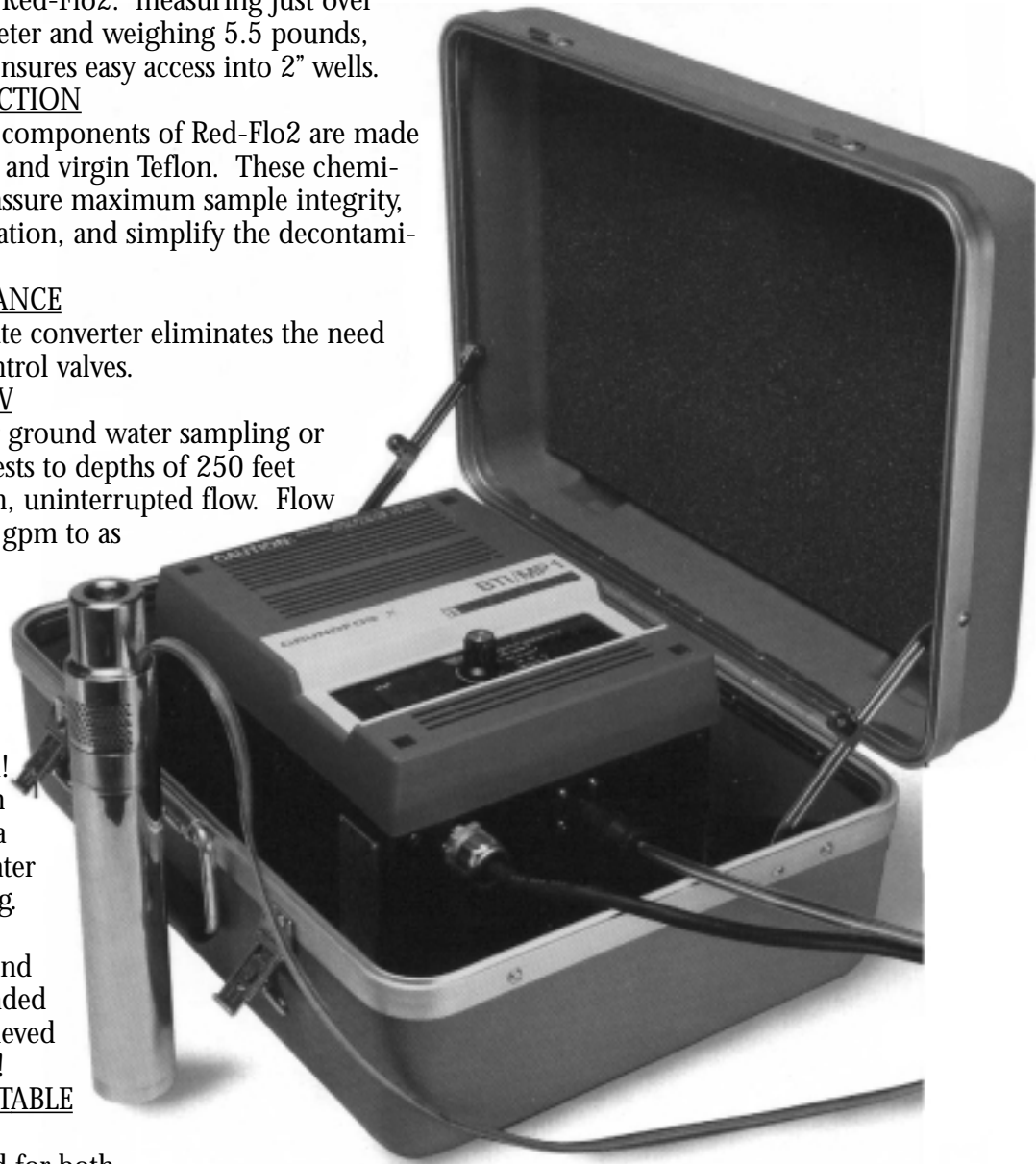

| | |
|-----------------------|--------------|
| 115V Converter | |
| FIG. NO. | PRICE |
| 46839 | |

Redi-Flo2 is designed for dedicated or non-dedicated sampling installations. By attaching the pump to a reel of tubing, it becomes fully portable.

Put the power of Redi-Flo2 into your daily operation. Once this pump is part of your sampling protocol, you'll wonder how you ever got along without Redi-Flo2.

Redi-Flo2

GRUNDFOS REDI-FLO2 VARIABLE SPEED PUMP

MP1

Redi-Flo2 Environmental Pump

Performance Curves

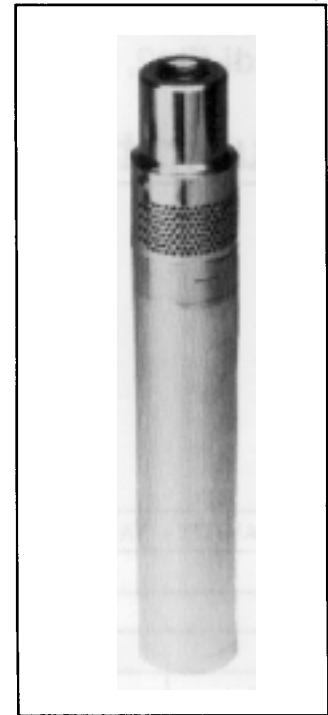
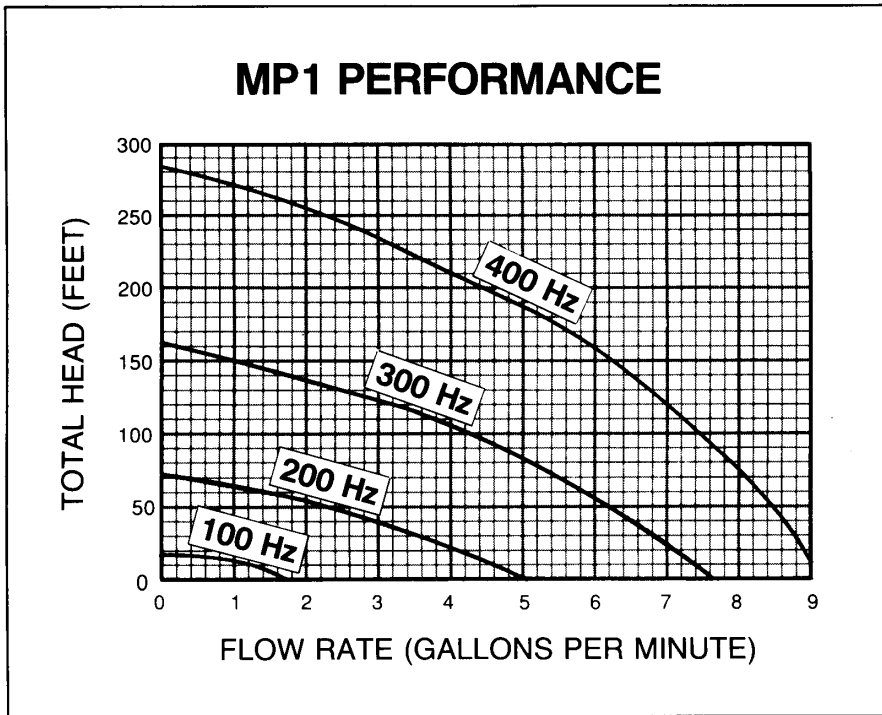

| MODEL # | FIG. NO. | CABLE LENGTH | PRICE |
|---------|----------|--------------|-------|
| MP130 | 47862 | 30 FT | |
| MP150 | 45054 | 50 FT | |
| MP175 | 45055 | 75 FT | |
| MP1100 | 45056 | 100 FT | |
| MP1200 | 45057 | 200 FT | |
| MP1300 | 45059 | 300 FT | |

**AVAILABLE IN 4" MODELS
CALL FOR SPECIFICATIONS**

DUFF SELLS SOLUTIONS
TO ALL YOUR
ENVIRONMENTAL NEEDS



SERVICE KITS FOR REDI-FLO2

Duff now offers kits to replace the impellers and teflon components within the pump, and a kit is now available to service the components that attach the Redi-Flo2 motor lead into the motor. Many of the new kits offer individual components available in larger quantities, so that more than one pump can be serviced.

Pump Components

| DESCRIPTION | USED PER PUMP | FIG. NO. |
|----------------------------|---------------|------------------|
| 1 Inlet Screen | 1 | 47488 |
| 2 Pump Housing 1/2" NPT | 1 | 47489 |
| 3 Guide Vane | 2 | see Service Kits |
| 4 Wear Ring | 2 | " |
| 5 Impeller | 2 | " |
| 6 Spacer Ring | 2 | " |
| 7 Wear Plate | 2 | " |
| 8 Motor Lead Assembly | 4 | see Pos. 13 - 18 |
| 9 Shaft | 1 | not available * |
| 10 Suction Interconnector | 1 | 47490 |
| 11 Stator Housing | 1 | not available * |
| 12 Set Screw | 1 | see Service Kits |
| 13 Ground Motor Screw | 1 | " |
| 14 Motor Lead Screw | 4 | " |
| 15 Teflon® Washer | 4 | " |
| 16 Brass Washer | 2 | " |
| 17 Grommet | 3 | " |
| 18 Crimped Pin | 3 | " |
| 19 Motor Screw (long) | 2 | " |
| 20 Motor Screw (short) | 6 | " |
| 21 Filling Screw w/ O-Ring | 1 | " |

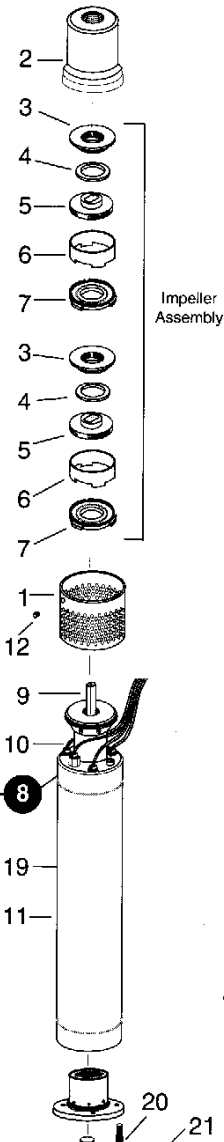

Teflon® is a registered trademark of Du Pont
 *Not economical to replace. Must purchase complete pump/motor

MOTOR LEAD ASSEMBLY

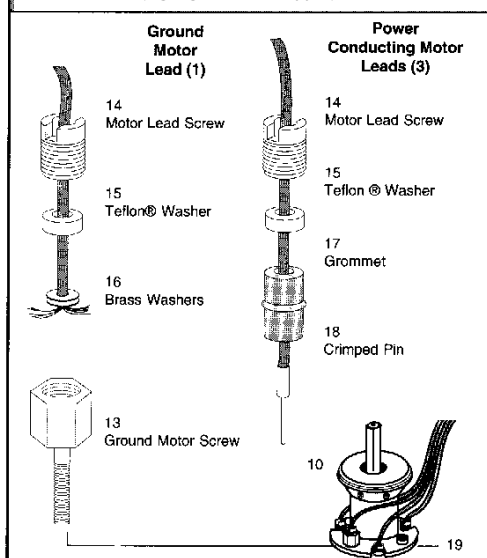

| SERVICE KITS | | | | |
|--------------|--------------------------|------------|----------|-------|
| Diagram No. | Parts Description | No. in kit | Fig. No. | |
| 3 | Guide Vane | 2 | 45060 | |
| 4 | Wear Ring | 2 | | |
| 5 | Impeller | 2 | | |
| 6 | Spacer ring | 2 | | |
| 7 | Wear Plate | 2 | | |
| 4 | Wear Ring | 4 | | 47477 |
| 7 | Wear Plate | 4 | | |
| 13 | Ground Mtor Screw | 1 | 47461 | |
| 14 | Motor Lead Screw | 4 | | |
| 15 | Teflon Washer | 4 | | |
| 16 | Brass Washer | 2 | | |
| 17 | Grommet | 3 | | |
| 18 | Crimped Pin | 3 | | |
| 5 | Impeller | 2 | 47478 | |
| 12 | Set Screws | 25 | 47479 | |
| 14 | Motor Lead Screws | 12 | 47480 | |
| 15 | Teflon Washer | 25 | 47481 | |
| 16 | Brass Washer | 25 | 47482 | |
| 17 | Grommet | 25 | 47483 | |
| 18 | Crimped Pin | 50 | 47484 | |
| 19 | Motor Screw (long) | 25 | 47485 | |
| 20 | Motor Screw (short) | 25 | 47486 | |
| 21 | Filling screw with Oring | 5 | 47487 | |

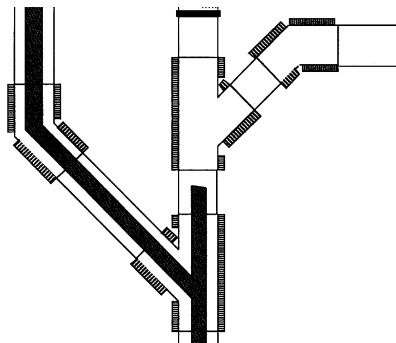

DOUBLE CONTAINMENT PIPING SYSTEMS

Call for Quotes!

610-275-4453

MONITORING WELL ACCESSORIES

2", 4" and 6" LOCKING PLUG.

One piece watertight temperproof. Bright plastic housing, brass wing-bolt, buna-N disc, and SS lock lever. Unit is made to plug, seal and lock-in-place on a 2", 4" or 6" pupe (sch 40 PVC) without special preparations to the pipe. "TEST WELL" warning is molded to the cap.

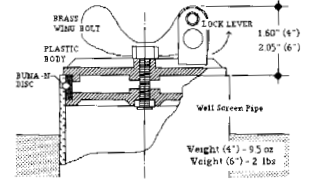

BASIC STYLE - TEST WELL MANHOLE

Regular access, non-watertight, economical. Consists of a cast iron lid and cast iron rim riveted to a galvanized sheet metal skirt. "TEST WELL" warning is cast directly on the lid. This manhole provides a simple economical box for monitoring wells in cases when 'limited access' or 'water-tight' features are not needed.

AVAILABLE SIZES: 9"x7", 9"x12", 12:x7", 12"x12".

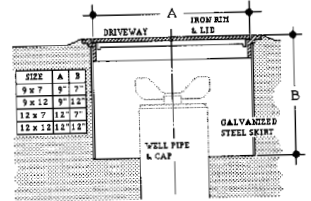

LIMITED ACCESS MANHOLE

Limited access, weather resistant, built to last. Consists of a cast iron lid and rim, replaceable "Buna-N gasket, galvanized sheet metal skirt, and stainless steel bolts. Lugs on inside of body rim are threaded for bolts to draw lid down tight. Bolted cover provides weather tight seal and 'limited access' feature.

AVAILABLE SIZES: 9"x7", 9"x12", 12:x7", 12"x12".

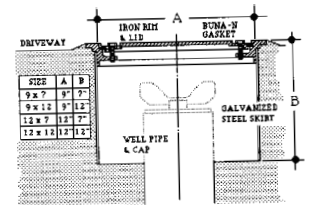

WATERTIGHT MANHOLE

True watertight, limited access, top-of-the-line. Consists of a full-cast, one-piece iron body and skirt, cast iron lid, brass spider, replaceable Buna-N gasket and stainless steel bolt. A brass ID plate is provided and permanent warning symbol affixed to the cover. The best of the line, made to provide many years of service.

AVAILABLE SIZES: 9", 12" and 12" WITH ALUMINUM COVER!

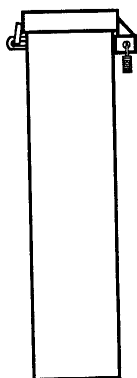
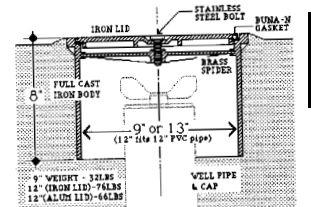

STEEL WELL PROTECTORS

All sizes in stock and ready for immediate shipment!

For 2" through 28" wells!



ENVIRONMENTAL PIPE

All screens & casing hermetically sealed (unless otherwise specified).

Custom manufacturing and perforating to your specifications.

PVC flush joint threaded well screen & casing - 1/2" to 14".

Manholes and locking well plugs.

Plain end well screen - 1/2" to 20"

HDPE flush joint threaded well screen & casing.

Slot sizes from .006 to .250.

Stainless steel flush joint well screen and casing.

Steel well protectors

APPLICATIONS:

Landfills, mines, septic and sewage systems, industrial drainage...USE YOUR IMAGINATION!

STANDARD AND NON-STANDARD CONFIGURATIONS ALWAYS AVAILABLE. CALL FOR QUOTES!

PERFORATED PIPE

With engineers requiring more and more complex specifications for drainage problems, the days of just using "pipe with holes in it" are over. Use perforated pipe to ensure desired results.

Available in PVC Types I and II, Polyethylene (HDPE), and fiberglass, our perforated pipe is customized to meet your specifications.

Primarily used for soil drainage, the varied forms of usage include highway underdrains, leachate collection systems, and septic leach fields.

LENGTH: Standard lengths of 10', 13' and 20' (241" max.). Custom lengths available up to 40'.

PIPE SIZES: Standard sizes from 3" to 12" nominal pipe size. Smaller and larger sizes available.

HOLE SIZES: Standard sizes from 1/4" to 1". Larger holes available.

HOLE SPACING: From 1 1/2" to 12" (center to center). Smaller and larger spacings available.

NO. OF ROWS: As per your specifications.

PATTERNS: Staggered or non-staggered.

PIPE SPECS: PVC SCH 40, 80, 120 and C-900 SDR 21, 26, 35. Various HDPE SDR's. Fiberglass.

END FITTINGS: Plain x Plain, Bell & Gasket, Bell and Spigot or Flush Joint Threaded.

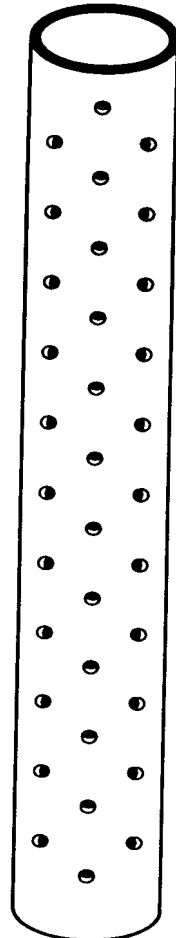

ENVIRONMENTAL PIPE

SCH. 40 PLAIN X POINT WELL POINTS

| PIPE SIZE | SLOT SIZE | SPACING | # ROWS |
|-----------|-----------|---------|--------|
| 1-1/4"X5' | .012 | 3/16" | 3 |
| | .014 | | |
| | .016 | | |
| 2"X5' | .012 | 3/16" | 3 |
| | .014 | | |
| | .016 | | |

SCH. 80 PLAIN

| PIPE SIZE | SLOT SIZE | SPACING | # ROWS |
|-----------|-----------|---------|--------|
| 1-1/4"X5' | .012 | 3/16" | 3 |
| | .014 | | |
| | .016 | | |



SCH. 40 PLAIN END WELL SCREEN

| PIPE SIZE | SLOT SIZE | SPACING |
|------------|-------------|---------|
| 1 1/4"X10' | .010-.020 | 3/16" |
| 1 1/2"X10' | .020 | 3/16" |
| 2"X10' | .006 & .008 | 3/16" |
| 2"X10' | .010 - .020 | 3/16" |
| 3"X10' | .010 & .020 | 3/16" |
| 4"X10' | .006 & .008 | 3/16" |
| 4"X10' | .020 | 3/16" |
| 4"X10' | .010 - .250 | 1/4" |
| 6"X10' | .020 - .250 | 1/4" |
| 6"X20' | .020 - .250 | 1/4" |
| 8"X10' | .020 - .250 | 1/4" |
| 8"X20' | .020 - .250 | 1/4" |
| 10"X10' | .020 - .250 | 1/4" |
| 10"X20' | .020 - .250 | 1/4" |
| 12"X10' | .020 - .250 | 1/4" |
| 12"X20' | .020 - .250 | 1/4" |

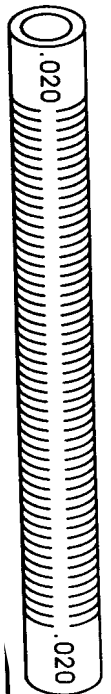

FLUSH JOINT PIPE AND CASING

2" - 4" SCH. 40
SLOT SIZES .010 & .020

| PIPE SIZE | SCREEN SPACING |
|-----------|----------------|
| 2"X2' | 3/16" |
| 2"X5' | |
| 2"X10' | |
| 2"X2' | Casing |
| 2"X5' | |
| 2"X10' | |
| 3"X5' | 3/16" |
| 3"X10' | |
| 3"X2' | |
| 3"X5' | |
| 3"X10' | |
| 4"X2' | 1/4" |
| 4"X5' | |
| 4"X10' | |
| 4"X2' | Casing |
| 4"X5' | |
| 4"X10' | |

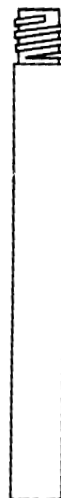

FLUSH THREADED FITTINGS

- 2" Plugs/Caps
- 2" Points/Male
- 2" Points/Female
- 2" Lifting Bail M/F
- 2" FJT Adapters
- 3" Flugs/Caps
- 3" Points/Male
- 3" Points/Female
- 4" Plugs/Caps
- 4" Points/Male
- 4" Points/Female
- 4" Lifting Bail M/F
- 4" FJT Adapters

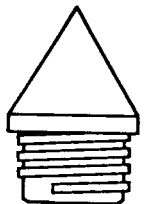
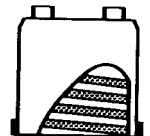

OIL/WATER SEPARATOR

Dyna-Pak Fiberglass Oil/Water Separator

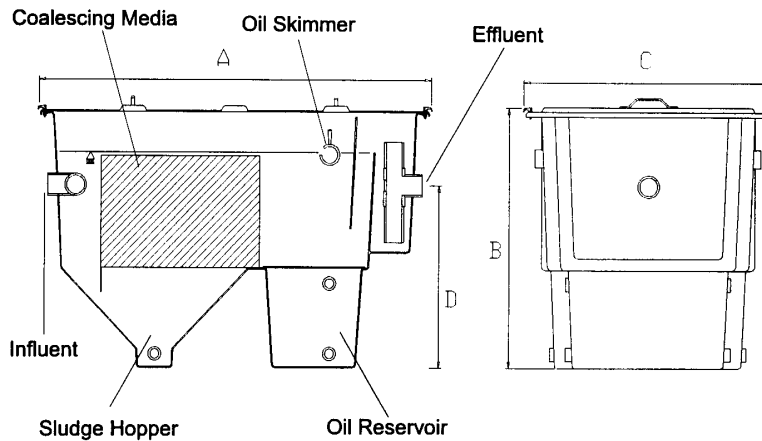

TYPICAL APPLICATIONS

Industrial Wastewater Treatment
 Chemical Processing Industries
 Petroleum Refinery
 Light & Heavy Manufacturing
 Ground Remediation
 Metal Finishing Industries
 Food Processing and Rendering
 Equipment Washpad Recycling

STANDARD UNIT DIMENSION CHART

| MODEL | A LONG Inches | B TALL Inches | C WIDE Inches | D ELEV Inches | INLET FITTING (inches) | OUTLET FITTING (inches) | OIL OUTLET FITTING (inches) |
|-------|---------------------|---------------------|---------------------|---------------------|------------------------------|-------------------------------|-----------------------------------|
| DP002 | 64 | 36 | 31 | 19 | 2 | 2 | 2 |
| DP004 | 76 | 39 | 31 | 21 | 2 | 2 | 2 |
| DP008 | 76 | 51 | 31 | 33 | 2 | 2 | 2 |
| DP012 | 76 | 51 | 43 | 33 | 3 | 3 | 3 |
| DP016 | 76 | 49 | 55 | 33 | 3 | 3 | 3 |
| DP024 | 88 | 57 | 55 | 39 | 4 | 4 | 3 |
| DP036 | 88 | 69 | 55 | 48 | 4 | 4 | 3 |

ACCURATE SIZING

QUALITY MANUFACTURING

MODELING SOFTWARE

BEST VALUE

Integral Oil & Sludge Storage

Wide Variety of Accessories

Wide Selection of Media Types

Flow Rates from 1 to 150 GPM

Standard & Custom Configurations

OIL/WATER SEPARATOR SIZING CHART

| MODEL | TYPICAL FLOW RATE GPM | TOTAL SEPARATOR CAPACITY (gals) | PROJECTED SURFACE AREA 1/2" PLATE SPACING | PROJECTED SURFACE AREA 3/4" PLATE SPACING | EMPTY WEIGHT (lbs.) | OIL CAPACITY (gals) |
|-------|--------------------------------|--|---|---|---------------------------|---------------------------|
| DP002 | 2-5 | 85 | 68 | 42 | 75 | 9 |
| DP004 | 4-10 | 105 | 136 | 84 | 150 | 11 |
| DP008 | 8-20 | 177 | 272 | 168 | 250 | 11 |
| DP012 | 15-30 | 300 | 408 | 252 | 350 | 25 |
| DP016 | 25-40 | 408 | 544 | 336 | 450 | 39 |
| DP024 | 35-75 | 508 | 816 | 504 | 750 | 54 |
| DP036 | 60-125 | 675 | 1224 | 756 | 1000 | 54 |

ACCESSORIES AND OPTIONS

The following accessories & options are just a few of the more popular selections available from Hydro-Flo Technologies. If you have a specific option or configuration in mind, please call. Our marketing & engineering staff can help you design the perfect oil/water separator for your application.

Platforms and Walkways

Special Fitting Configurations

Special Resin Blends & Gel Coats for Corrosive Environments

Optional Materials of Construction (Carbon Steel, Stainless Steel, Etc.)

Freeze Protection Packages

Pump Systems for Influent, Effluent, Oil & Sludge

1/2, 3/4, 1-1/4 Media Plate Spacing

PVC, CPVC, FRP, Stainless Steel, Carbon Steel Coalescing Media

**CALL DUFF COMPANY
 FOR ALL YOUR
 OIL-WATER
 SEPERATOR NEEDS!
 601-275-4453**

APPLICATIONS FOR OUR DP-SERIES OIL/WATER SEPARATORS

Automotive Industry - assembly line maintenance
Automotive Maintenance Facilities - engine washing facilities
process water
Airports - maintenance facilities
Bus Terminals - maintenance facilities
Bulk Plants - maintenance facilities
Chemical Plants - process water
Cooling Water - discharge
Compressor Blow Down - process water
Cosmetics Industry - process water
Electro Chemical Plants - rinse water
Fabricated Metal Plants - maintenance facilities
Floor Drains - process water
Food Processing Plants - removal of oil and grease from
waste water
Glass Factories - process water
Golf Courses - discharging pesticides (mostly for the pres-
sure washer)
Grinding and Honing Operations
Ground Water Remediation - removal of oil, sludge and
solids from ground water.
Ground Water Runoff - parking lot runoff
Industrial Plants - removal of oil and solids from wash
down water and waste water.
Lens Grinding and Polishing
Machining Operations - removal of cutting and tramp oil
from soluble cutting oils.
Machine Shops - process water
Marine Terminals - removal of oil and solids from wash
down water and waste water
Metals processing - maintenance facilities
Military Bases - maintenance facilities
Oil Industry (onshore and offshore) - refinery and drilling
runoff, tank cleaning, recovery of emulsified crude, recov-
ery of down hole water for stream injection

Oil Fields - maintenance facilities
Oil Production - oil removal from produced water
Oil Refineries - oil and sludge removal from process
streams and waste water.
Paving Contractors
Parking Areas
Petrochemical - oil, sludge and solids removal from process
streams and waste water
Petroleum Plants - process water, parking lot runoff
Ponds - runoff water
Power Plants - removal for transformer oil from waste
water.
Pulp and Paper Mills - process water
Railroad - Hot tanks, fueling runoff, locomotive washing
Rolling Mill Quench Oil - process water
Steam Cleaning Facilities - maintenance facilities
Steel Mills - removal of oil and solids from process water,
cooling water and waste water.
Tank Cleaning - process water
Textile Mills - process water
Tramp Oil Separation
Truck Maintenance Terminals - removal of oil and solids
from wash down water and waste water, parking lots and
retention ponds.
Utility Companies - Water from fuel washing, fuel oil cen-
trifuges, blow down water from air receivers
Vegetable Processing Plants - removal for sand and clay
from wash water
Wire Drawing Operation - process water
Wash Racks - process water
Wash/Rinse Tanks
Water Treatment Plants - flocculation removal from water

CARBON FILTRATION UNITS FOR LIQUID AND VAPOR

STANDARD EQUIPMENT

- *55 Gallon drum carbon adsorbers (metal or poly, vapor or liquid)
- *Fiberglass adsorbers
- *Powdered carbon dosing systems
- *75 psi pressure vessels - up to 12' diameter
- *40 psi low pressure vessels - up to 4' diameter
- *Vapor jumbo drum adsorbers
- *High & low pressure bag (sock) filters



OTHER FILTRATION PRODUCTS

- *Anthracite
All mesh sizes available in one cubic foot bags.
- * Filter Sand
All grades of quartz, silica and garnet in bags and bulk.
- * Quartz Filter Gravel
All grades in bags and bulk.
- *Ion Exchange Resin
Removes minerals and metals from water. All grades of gel and acrylic cationic and anionic resins.
- * Manganese Green Sand
Removes iron and manganese from water.

CUSTOM EQUIPMENT

- Activated carbon systems
 - *Dual 2000 pound to 20,000 pound skid
 - *Cross flow vapor adsorbers and roll off vapor adsorbers up to 10,000 SCFM
- Water softeners
- Demineralizers
- Sand or multi-media filters
- Air strippers
- Complete skid or trailer mounted remediation systems
- ASME coded pressure vessels with stamp
- Specialty coatings and internal
- Systems per client specifications

MEDIA

Activated carbon removes organics from air or water. Lignite, Bituminous, Peat, Impregnated and Specialty Grades available in all standard standard mesh sizes.

8X30 GRANULAR ACTIVATED CARBON FOR LIQUID FILTRATION

DWC 8x30 is a virgin granular activated carbon made from selected grades of bituminous coal. This product is specifically designed for liquid phase applications here high surface area is needed for maximum adsorption.

Properties and Specifications

| PROPERTIES | VALUE | TESTING METHOD |
|----------------------------|------------------------|----------------|
| Iodine Number | 900 mg/g | AWWA B604 |
| Abrasion Number (min.) | 75 | ASTM D3802 |
| Moisture as Packed (max.) | 4% | ASTM D2867 |
| Apparent Density | 0.50 g/cc | ASTM D2854 |
| Mesh Size | 8x30 | U.S. Sieve |
| greater than 8 mesh (max.) | 5% | U.S. Sieve |
| less than 30 mesh (max.) | 5% | U.S. Sieve |
| Surface Area (typical) | 1050 m ² /g | BET N2 |
| Ash Content (max.) | 12% | ASTM D2866 |

COCONUT SHELL GRANULATED ACTIVATED CARBON FOR VAPOR FILTRATION

DWC CARBON is a virgin activated carbon manufactured from select coconut shell raw material and thermally activated in a rotary kiln with a steam atmosphere. This carbon is specifically developed for vapor phase applications where it provides superior performance for recovery of low concentration contaminants and odors from the air streams and industrial gases. This carbon product has a characteristically low ash and high hardness suitable for solvent recovery applications.

Properties and Specifications

| PROPERTIES | VALUE | TESTING METHOD |
|---------------------------------|------------------------|----------------|
| Carbon Tetrachloride No. (min.) | 60% | ASTM D3467 |
| Hardness (typical) | 97% | ASTM D3802 |
| Moisture as Packed (max.) | 5% | ASTM D2867 |
| Bulk Density | 0.48 g/m ² | ASTM D2854 |
| Mesh Size | 4x8 | U. S. Sieve |
| greater than 4 mesh (max.) | 5% | |
| less than 8 mesh (max.) | 5% | |
| Surface Area (typical) | 1150 m ² /g | BET N2 |
| Ash Content (max.) | 3% | ASTM D2866 |
| Pore Volume (typical) | 0.50 ml/g | |
| pH Water Extract (typical) | 9.5 | |

LIQUID FILTRATION UNITS

24 1/2" O.D. x 34 3/4" high
UN# Rated multi-trip canister
with a lock ring open top lid

1 1/4" FPT
Connection

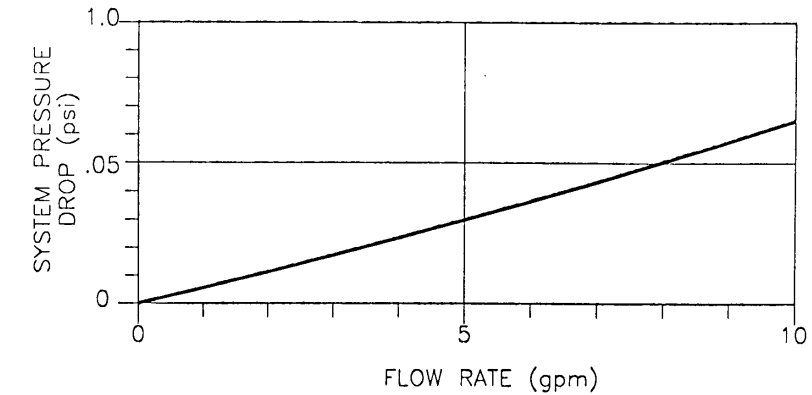
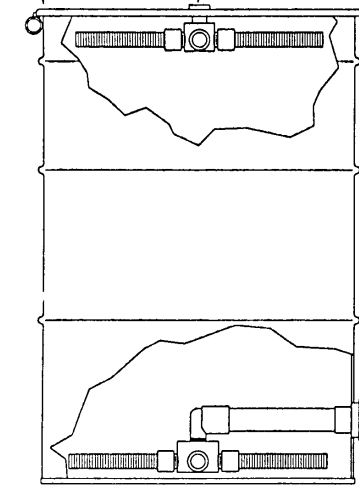

DWL200-L Series drums are 16 gauge carbon steel with an internal epoxy lining and external urethane corrosion resistant coating. Upper and lower hub and lateral distribute collection system prevents media migration and channeling, for maximum carbon utilization. Either connection can be used as the inlet/outlet, allowing for up flow or down flow operation. 10 gpm flow at 10 psi is recommended.

1 1/4" FPT
Connection

VAPOR FILTRATION UNITS

24 1/2" O.D. x 34 3/4" high
UN# Rated multi-trip canister
with a lock ring open top lid

2" FPT
Connection

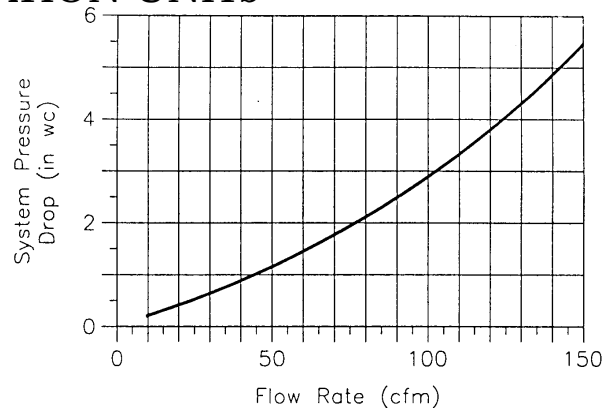
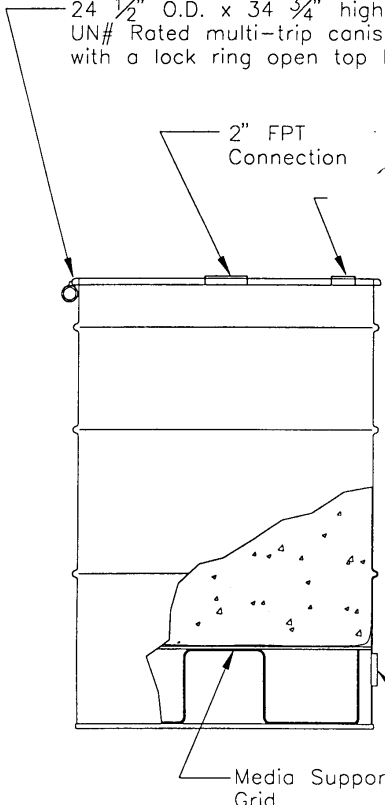

DWV200-V Series drums are 16 gauge carbon steel with an internal epoxy lining and external urethane corrosion resistant coating. Upper and lower vapor plenums distribute influent air/vapor stream preventing preferential flow through a 2'-0" depth of carbon bed. Either connection can be used as inlet/outlet, allowing for up flow or down flow operation. Rated to 150 cfm, 10 psi and 10" of mercury vacuum.

APPROX. LOADED WEIGHT = 200 lbs.

2" FPT
Connection

Media Support
Grid

TYPICAL FILTER INSTALLATION

TYPICAL INSTALLATION

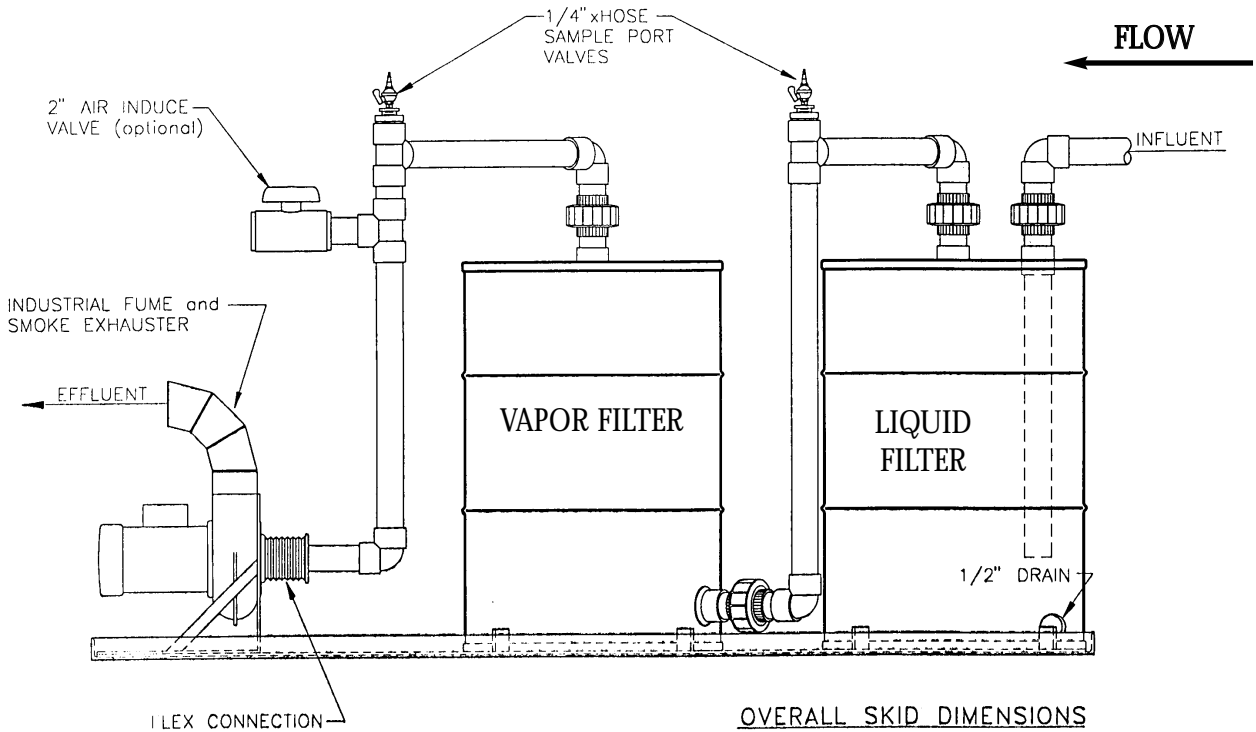

OVERALL SKID DIMENSIONS
 2-DRUM SKID - 7'-6" L x 2'-0" W x 4'-7" H
 3-DRUM SKID - 7'-6" L x 4'-0" W x 4'-7" H

**FIBERGLASS
 FILTRATION
 TANKS**

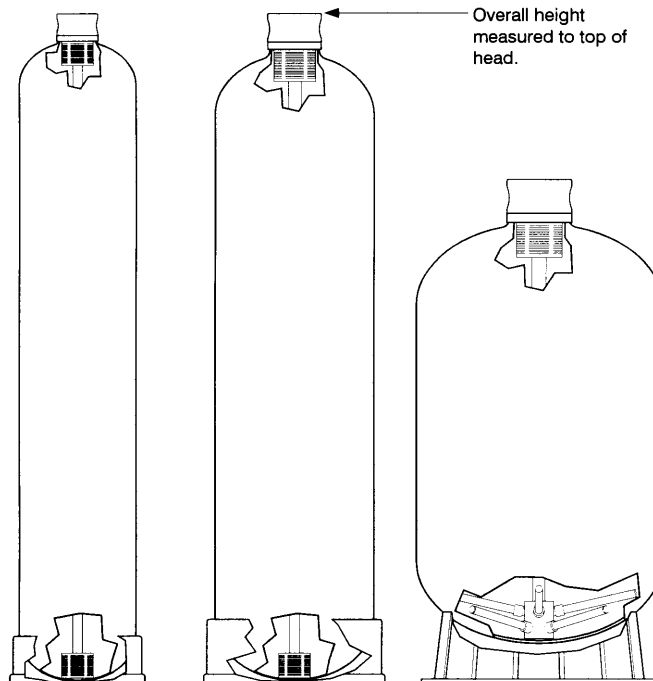

Available Options:

- Custom Sizes Designed to hold up 2000 lbs GAC
- ASME Code Stamp
- Vacuum Relief
- Higher Pressures available
- Available with or without internals
- Custom Colors
- Pressure Indicators
- Side Mounted Inlet/Outlets
- Custom Sizes
- Sight Glasses
- Extended, Tripod or Bolted Base
- Piped Automatic Systems
- Call for your custom configuration

**ALL SIZES,
 CONFIGURATIONS AND
 DESIGN REQUIREMENTS
 CAN BE MET!**

GEOTEXTILES

TYPICAL APPLICATIONS

- **Woven Geotextiles**

Monofilaments, High Strength, Slit Films, Custom Design and Production

- **Nonwoven Geotextiles**

3 to 30 Ounces Per Square Yard

- **Silt Fences**

Prefabricated with Posts or Fabric Only

- **Erosion Control Mats / Blankets**

Biodegradable Straw and Wood Excelsior, Permanent Turf Reinforcement, Jute Mesh

- **Sand / Grout Bags**

- **Daily Landfill Covers**

Reinforced Heavy Duty and Light Weight Disposables for Winter

- **Geogrids**

- **Geocell Containment Systems**

- **Safety / Barrier Fences**

- **Factory Fabrication**

Custom Widths, Lengths, and Shapes

Erosion Control / Riprap

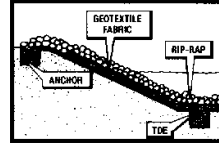

- Woven Monofilament Filter Fabrics
- Nonwovens (Non-critical Applications - Depending on Soil Conditions)

Separation / Stabilization / Reinforcement

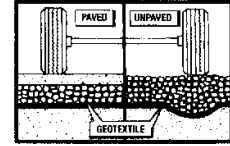

- Woven Slit Film & High Performance Fabrics
- Nonwovens (Separation Only)

Subsurface Filtration / Drainage / Septic

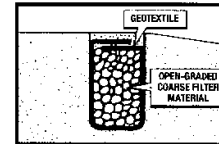

- Woven Monofilament Filter Fabrics
- Nonwovens (Non-critical Applications - Depending on Soil Conditions)

Silt Fence

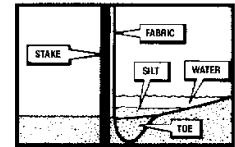

- Woven Monofilaments, Slit Films, & Specialty Sedimentation Fabrics

Daily Landfill Covers

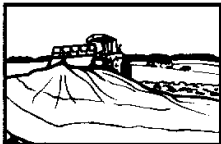

- Reinforced Heavy Duty & Light Weight Disposables for Winter Months

Steep Slopes

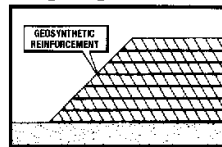

- Woven Slit Film & High Performance Fabrics
- Geogrids • Erosion Control Products

Erosion Control / Revegetation

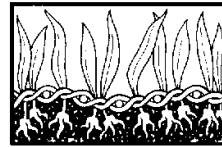

- Straw & Wood Excelsior Blankets, Permanent Turf Reinforcement, Jute, Geoc

Sand Bags (Large) / Shoreline Protection

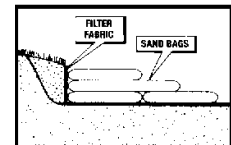

- Woven High Performance Fabrics and Monofilament Filter Fabrics

Embankments Over Soft Soils

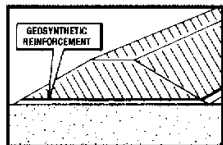

- Woven Slit Film & High Performance Fabrics
- Geogrids (With Geotextile Separator)

Geocell Containment Systems



- Slopes, Channels, Walls, Shorelines, Haul Roads, Parking Areas, Driveways, Erosion Control, Vegetation

Landscape / Weed Control

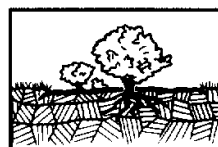

- Special Light Weight Wovens & Nonwovens
- High UV Resistance

Safety / Barrier Fences

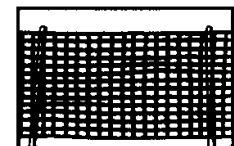

- Work Sites, Crowd / Traffic Control

POLYETHYLENE DRAINAGE PIPE

Advantages

When you install ADS tubing, you can be sure it will provide dependable drainage for many years to come. Problems that often surface with other drainage materials simply don't occur with ADS tubing. Drainage is economically efficient because ADS tubing is:

Easy to Install.

Lightweight tubing saves time and labor. No special tools or fittings are needed. There's no waste because you simply cut coiled tubing to required length.

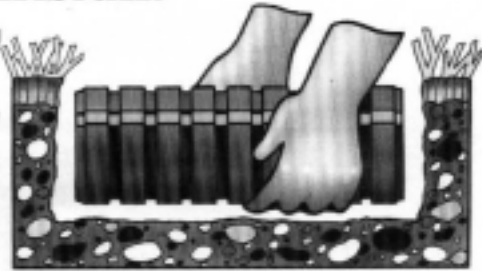

Unrestricted Water Intake.

Uniform slots provide unrestricted, rapid water intake and quicker drainage to handle



When you install ADS tubing, you can be sure it will provide dependable drainage for many years to come. Problems that often surface with other drainage materials simply don't occur with ADS tubing. Drainage is economically efficient because ADS tubing is:

Advantages

When you install ADS tubing, you can be sure it will provide dependable drainage for many years to come. Problems that often surface with other drainage materials simply don't occur with ADS tubing. Drainage is economically efficient because ADS tubing is:

Easy to Install.

Lightweight tubing saves time and labor. No special



Unrestricted Water Intake.

Uniform slots provide



FOR ALL OF YOUR ENVIRONMENTAL NEEDS, CALL DUFF FIRST!

610-275-4453

SUGGESTED APPLICATIONS:

- *Storm Drainage systems
- *Culverts and cross drains
- *Roadway edge drains
- *Foundation drainage
- *Downspout drainage
- *Subdrainage
- *Edge drains
- *Culverts
- *Agricultural drainage
- *General drainage
- *Golf course drainage

SEE PAGE 599 FOR FULL LINE

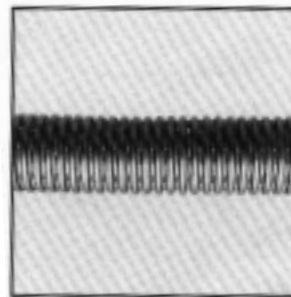

DUFF IS A LEADING PROVIDER OF POLYETHYLENE PIPE SYSTEMS

PE 3408 EXTRA HIGH MOLECULAR WEIGHT (EHMW) HIGH DENSITY POLYETHYLENE INDUSTRIAL PIPING SYSTEM

Some of the industries using high density polyethylene pipe systems and their varied applications are:

INDUSTRIES

Agricultural (irrigation)
 Chemical
 Dredging
 Fertilizer
 Gas Distribution
 General Industrial
 Landfill Reclamation
 Metals Extraction
 Mining
 Oil and Gas Production
 Power Generation
 Pulp and Paper
 Sewage
 Water Distillation

SPECIAL SERVICES

Fire Protection*
 Potable Water**
 Hazardous wastes
 Duct

*Factory mutual certification available

**NSFpw certification available

APPLICATIONS

Acid Lines
 Coal Bed Methane Drainage
 Condensate Lines
 Corrosive Wastes
 De-watering
 Drainage Lines
 Fiber Optic Innerduct
 Fly Ash Disposal
 Ground Source Heat Pumps
 Irrigation Lines
 Landfill (leachate control and methane recovery)
 Natural gas and Oil Lines
 Process Water Lines
 Relining (chemical lines and sewers)
 Salt Water Intakes
 Sanitary & Force Mains
 (gravity and pressure)
 Sludge Lines
 Slurry Lines
 Tailings Lines
 TV Cable Conduit



PIPE AND FITTINGS



SPECIAL FABRICATIONS



BUTT FUSION EQUIPMENT

MACHINES AVAILABLE FOR SALE OR RENT

High density for strength, stiffness, chemical resistance
 Extra high molecular weight for toughness, durability, impact resistance, abrasion resistance
 Broad molecular weight distribution for fusibility and eas of joining
 Outstanding ESCR for durability and resistance to aggressive soils and fluids

DUFF OFFERS A COMPLETE LINE OF ALL YOUR CONNECTING NEEDS

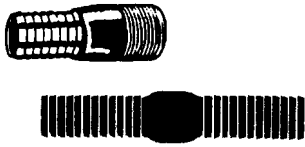

Hose insert connection for suction & layflathoses.
Steel and Brass see page 433
Plastic see page 610
Stainless Steel see page 432

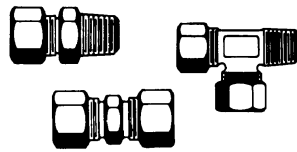

Compression fittings for tubing connections.
Brass see page 117-122
Plastic see page 574-575

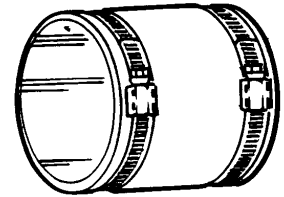

For connecting non-pressure piping.
Steel -or- plastic see page 103

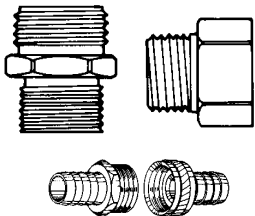

For connecting contractor and garden hose thread to pipe thread.
See page 100

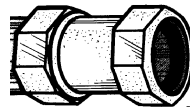
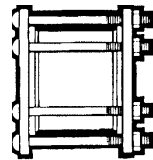

For connecting piping under pressure.
Steel or plastic see page 65-55

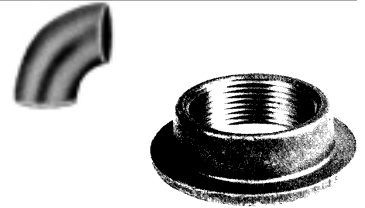

Fittings for ballards and tank fabrication.
See pages 79

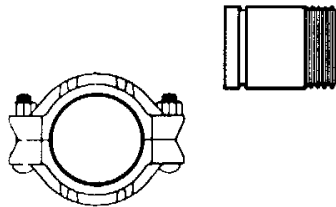

Permanent or temporary piping applications.
See page 81

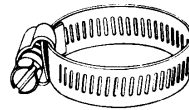

Stainless Steel clampS
See page 611

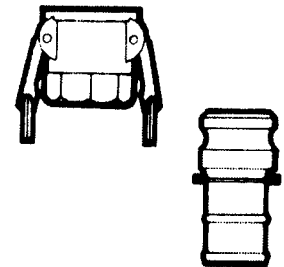

See page 618

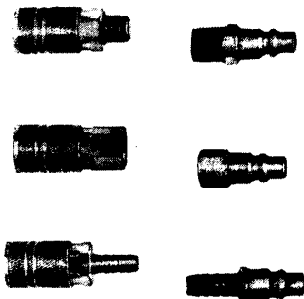

See page 628



Brass Saddle Tees
See page 57

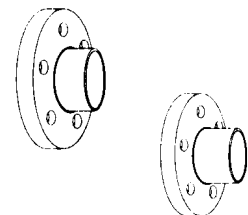

Flanges - available in PVC, CPVC, also in Steel and Cast Iron
CPVC See page 589
PVC see page 585
Cast Iron see page 59
Steel see page 77

FIBERGLASS & POLYETHYLENE TANKS

- * Fiberglass
- * Polyethylene (HDPE)
- * Cross Linked (XLPE)
- * Dual Laminate
- * Vertical & Horizontal
- * Single & Double Wall
- * Closed & Open Top
- * Flat & Cone Bottom
- * Skid Mounted Tanks

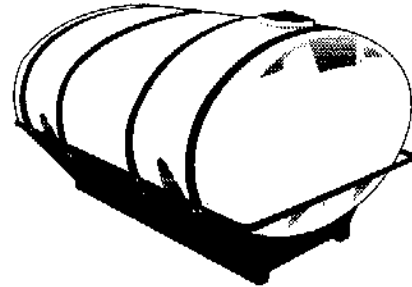
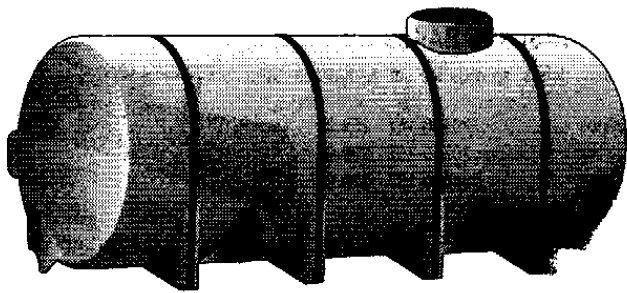
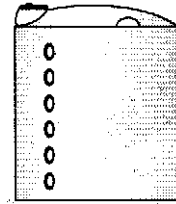

- * Low Profile Tanks
- * Bulk Storage Tanks
- * Space Saver Tanks
- * Truck Tanks
- * Sprayer Tanks
- * Tractor Mount Tanks

* Capacities to 20,000 gallons

METERS

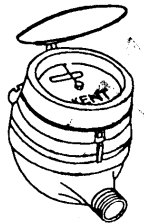

WATER METERS AND FLOW METERS
READILY AVAILABLE
SEE PAGE 367 TO 369



TANK TRUCK HOSE

Tube: Black nitrile synthetic rubber.

Reinforcement: High tensile steel wire between two layers synthetic textile.

Cover: Black neoprene rubber with red stripe.

Applications: Designed for handling petroleum products up to 45% aromatic under rugged suction and discharge conditions. Extremely flexible. Temperature range from -40°F to +180°F. Sizes 1 1/2", 2", 3", 4"

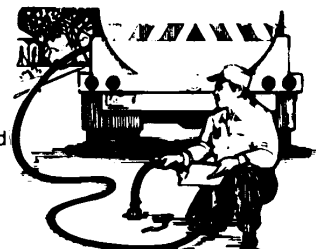

HEAVY DUTY TANK TRUCK HOSE

Style P1193

Tube: Black nitrile.

Reinforcement: 100% polyester woven around close pitch steel helical wire.

Cover: Black nitrile.

Applications: Unique construction gives this hose up to twice the working pressure of conventional tank truck hose. Highly resistant to acids and petroleum products. Light weight, crush and kink resistant. Recommended for oil exploration/drilling, waste hauling. Temperature range from -20°F to +180°F. Sizes 1 1/2", 2", 3", 4"

SEE ALL
OUR HOSES
ON PAGES
616-617

PVC SUCTION HOSE

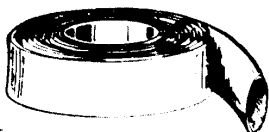

RUBBER SUCTION HOSE



PVC DISCHARGE HOSE

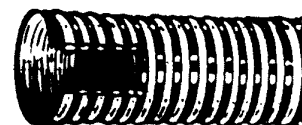

HARMSCO UP-FLOW CARTRIDGE FILTRATION

A Design So Superior It's Patented!

Harmsco's up-flow design out performs conventional filters! Fluid enters the filter under pressure and flows through the filter media, holes in the center tubes and perforations in the rods that hold the cartridges in place. As the fluid continues its path, it flows upward past the top seal where it spills over into the standpipe as it hits the filter's domed lid. The top of the standpipe is at the high point of the filter. Also, note the the filter cartridges are sealed at the bottom and held in place with threaded pipe caps.

UP-FLOW Stainless Steel Industrial "filter Housings

Cartridge filters (304 stainless steel, CPVC standpipes, CPVC cartridge holders and threaded caps)

Cartridge cluster filters (to remove entire set of cartridges at one time for cleaning or replacement)

***No Air Entrapment** Large capacity filters with cartridge filters for easy cartridge removal

***No Vents**

***No Fluid By-Pass During Servicing**

***Electro-Polished**

***Fail-Safe Lids**

***Compact Design**

***Pressure Rated to 150 psi**

***Cartridge Cluster Filters**

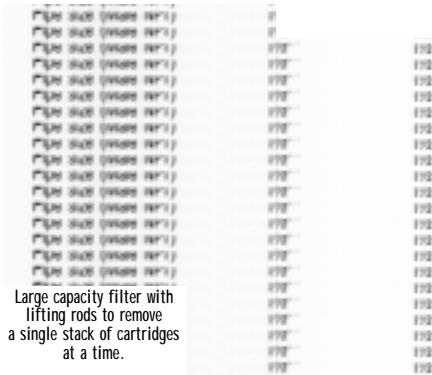

Cartridge cluster filter with easy cartridge removal for cleaning or replacement.



THE REVOLUTIONARY HARMSCO HURRICANE

COMBINES THREE FILTRATION TECHNOLOGIES IN A SINGLE COMPACT DESIGN

CENTRIFUGAL SEPARATION TO REMOVE DENSE PARTICLES FROM LIQUIDS

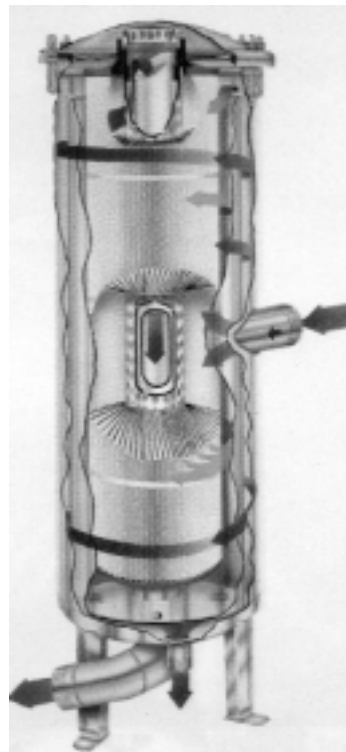

UP FLOW CARTRIDGE FILTRATION AND ANGLES PLEATS FOR LIGHT-WEIGHT PARTICLE REMOVAL

HARMSCO STAINLESS BAG FILTER



PLEASE SEE PAGE 485-486 FOR BAG FILTERS!

SAFETY STATIONS

EYE/FACE WASHES
AND SHOWER STATIONS

**FOR SPECIFIC MODELS, SEE
PAGE 251 OR CALL FOR
QUOTE!**

AVAILABLE

- * Corrosion resistant PVC
- * Corrosion resistant stainless steel
- * Freeze resistant
- * Walk through decontamination
- * Eye, face and body spray units

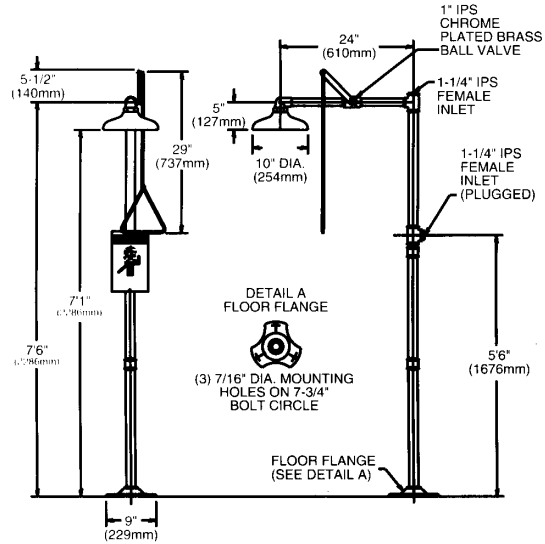

SPEAKMAN
The Quality Leader Since 1869

Haws®

GUARDIAN EQUIPMENT

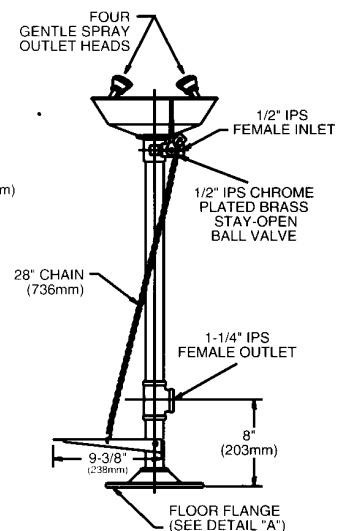
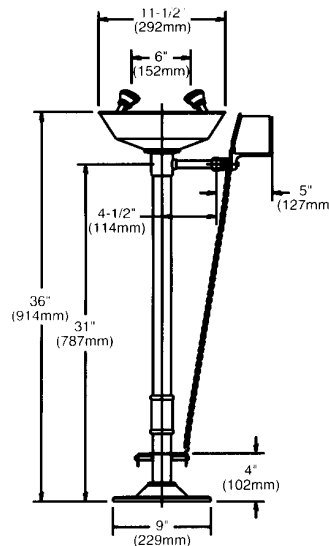
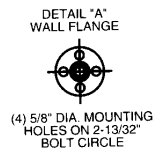
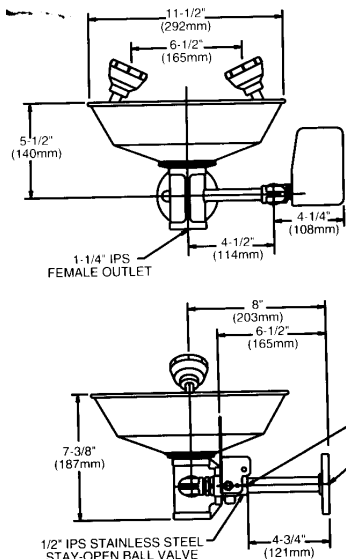

GLOSSARY

ABRASION: Migration of foreign material which enters the fluid stream from system components that wear from close tolerances, vibration or shock.

ABRASIVES: hard structurally strong solid.

ABSORB: To take up by cohesive, chemical or molecular action.

ABSORBENT: A filter medium that holds contaminants by mechanical means. When one substance soaks completely through another, sometimes undergoing a chemical change.

ACIDITY: The quality, state or degree of being acid. In lubricating oils, acidity denotes the presence of acid-type constituents whose concentration is usually defined in terms of a neutralization number. The constituents vary in nature and may or may not markedly influence the behavior of the fluid.

ADDITIVE: A material, usually chemical, added to a product to impart new or unusual characteristics or to improve existing characteristics.

ADSORBENT: A filter medium primarily intended to hold soluble and insoluble contaminants on its surface by molecular adhesion - no chemical change.

ADSORPTION: The natural phenomenon of a gas, vapor, or liquid being attracted to and held on the surface of a solid. To some extent adsorption takes place on any solid surface, but certain materials have sufficient adsorbent capacity because of the finely divided material to make them useful in such industrial applications as the purification and separation of gasses and liquids.

AGGREGATE: A relatively stable assembly of dry particles formed under the influence of physical forces.

AMBIENT: Surrounding. For example, ambient operating temperatures of a vessel is temperature essentially the same as that surrounding the vessel.

ASME: American Society of Mechanical Engineers.

ATMOSPHERIC PRESSURE: The force exerted on a unit area by the weight of the atmosphere.

ATOM: Smallest particle of an element which retains properties of the element. Example: Carbon Atom (C).

BACK PRESSURE: In filter use, resistance offered by filter, usually measured in PSI.

BACKWASH: To clean a filter element by reversing the direction of flow through it.

BLOTTER TEST: A visible means of checking oil clarity; one drop on a blotter will concentrate dirt or foreign matter in the center of the ring.

BLOWBACK: To reverse flow air, steam or fluid through the media to effect solids removal. Sometimes referred to as backwash.

BUNA N: Gasket material. A synthetic rubber frequently used for vessel closures, flanges, and filter elements.

CAKE: Solids deposited on the filter medium during filtration in sufficient thickness to be removed in sheets of sizable pieces. In many cases, cake may provide its own filter media by adding to the surface of media. Also referred to as discharged solids or residue.

CAPACITY: Volume of product which a vessel will accommodate. This is expressed in gallons or similar units. Also amount which will filter at a given efficiency and flow rate, expressed in gallons per minute or similar units.

CARTRIDGE: medium used in a vessel to perform the function of coalescing, filtering, or separating. Also referred to as element, media, repack, etc. Made in a specified physical shape to be mounted by use of hardware designed for that purpose.

CONTAMINANT: Anything in the fluid that should not be there.

CONTAMINATE: The foreign matter in a fluid which is accumulated from various sources such as system dirt, residue from wear of moving parts, atmospheric solids which settle in an open system. Contaminates tend to discolor a liquid, cause additional wear on moving parts, cause system upsets in process stream, or reduce the efficiency of a fluid. Water as well as solid may be considered a contaminate when the presence of water causes adverse results. The presence of contaminates, whether liquid or solid, is the basis on which the use of filters or separator/filters are sought.

CORROSION: The conversion of metals into oxides, hydrated oxides, carbonates, or other compounds due to the action of air or water or both. Salts and sulphur are also important sources of corrosion. Removal of solids and water reduces the effect or speed of corrosion in many cases; and in other cases, corrosion inhibitors are used to reduce the effect of corrosion.

DENSITY: The weight per unit volume of a substance (specific weight).

DEPTH: A filter medium which primarily retain contaminants within the tortuous passages within the depth of the element wall.

DEPTH TYPE FILTRATION: Filtration accomplished by flowing a fluid through a mass filter media provided a tortuous path with many entrapments to stop the contaminates. Flow may be cross flow such as from the outside or inside and then down the center of an element, or from end to end. Certain types of solids, or combinations of solids, do not lend to surface filtration and depth type filtration is found to be more suitable.

DIELECTRIC: A substance which will not conduct electricity. A non-conductor.

DIFFERENTIAL PRESSURE: The difference in pressure between two give points of a filter, separator/filter, etc.

DUAL DENSITY: A depth element that is constructed of two different medias not blended into a homogeneous mixture but remaining as two different distinctive medias.

EFFICIENCY: Degree to which element will perform in removing solids and/or liquids. Output divided by input.

ELEMENT: Medium used in vessel to perform the function of coalescing, filter or separating. Also referred to as a cartridge, repack, etc. The porous device which performs the actual process of filtration.

ELEMENT BY-PASS VALVE: A valve within a filter to limit the differential pressure which can be impressed across the filter element.

EMULSIFICATION: A dispersion of one substance in the form of minute drops within another substance.

EMULSION: A dispersion of fine liquid particles in a liquid stream which do not necessarily dissolve in each other but are held in suspension. Many emulsions may be broken by coalescing the liquids are immiscible. Emulsion stabilizers modify the surface tension of the droplets which makes coalescing difficult, if not impossible.

FILTER: A term generally applied to a device used to remove solid contaminate from a liquid or gas, or separate one liquid from another liquid or gas. A filter, as referred to in the industry today, is a device which removes contaminates. If a device used to remove solids and liquids contaminates, it is referred to in general terms as a separator, separator/filter, or entrainment separator. A filter may be one of a number of such types as replaceable cartridge, cycle, edge, leaf, baffle, plate and frame, precoat and centrifuge. The term filter is sometimes erroneously use to describe the media used inside the vessel or filter case, but the correct use should be filter element, cartridge, etc.

FILTER EFFICIENCY: Expressed as a percent of contaminant introduced to the system, it is the ability of a filter to remove specified contaminants at a given contaminant concentration under specified test condition.

FILTER ELEMENT LIFE: Span of operation from clean unit to a pre-determined pressure drop build up - usually measured in lapsed time.

FLOW RATE: The rate at which a product is passed through a vessel or system: generally expressed as gallons per minute; barrels per hour, barrels per day, actual or standard cubic feet per minute, hour day, etc.

FLUID: A liquid or gas which can be filtered by passing through a filter.

FREE WATER: Water entrained in a lubricating oil or fuel forming two distinct phases with the fluid and having a tendency to separate as a result of the differences in densities.

HOLDING CAPACITY: In general usage refers to the amount of solids, particulate or foreign material one or more elements is capable of retaining up to the terminal or maximum differential pressure. Also can refer to volumetric holding capacity of either a solid or a liquid.

HYDRAULICS: The study of fluids at rest or in motion.

IMPURITY: See "contaminant" - any undesirable material in the fluid.

INDICATOR, BYPASS: An indicator which signals alternate flow.

LACQUER: A natural or synthetic resin which is dissolved in a suitable solvent such as hydrocarbon oil rich in aromatics. When applied, the oil solvent evaporates, leaving behind a lacquer film.

LINE SIZE: The size of line used to carry the product in a system, such as a six inch line.

MICRON: A short unit of length in the metric system. One millionth of a meter, 10⁻⁴ centimeter, 10⁻³ millimeter or 0.000039 of one inch. Used as a criterion to evaluate the performance or efficiency of a filter media or to describe the condition of either the influent or effluent. Usually stated in terms of being either absolute or nominal. Nominal micron rating is generally taken to mean that 98% of all particles over a given micron value have been removed by a specific media or medium. Absolute micron rating is generally taken to mean that all particles over a given micron value have been removed. The naked eye can see a particle 40 microns or larger.

MIGRATION: Contaminant or media released downstream from the filter element.

PREFILTER: Filter for removing gross contaminants before the product stream enters a separator/filter.

PRESSURE ATMOSPHERIC: The force exerted by the atmosphere at sea level, which is equivalent to 14.7 psi.

PRESSURE DIFFERENTIAL: The difference in pressure between two points.

PRESSURE DROP: The difference in pressure between two points, generally at the inlet and outlet of a filter or a separator/filter. Measured in pounds per square inch gage, or inches of mercury.

PRESSURE RATING, OPERATING: The normal pressure at which a filter housing is capable of operating at specified operating conditions.

PRESSURE RELIEF: Valve which permits enough liquid or gas to escape from the vessel to prevent extreme pressure build up within the vessel.

PSI: Pounds per Square Inch.

PSIA: Pounds per Square Inch Absolute.

PSID: Pounds per Square Inch Differential.

PSIG: Pounds per Square Inch Gage.

RATE OF FLOW: The rate at which a product is passed through a vessel or system; generally expressed as gallons per minute, barrels per hour, barrels per day, actual or standard cubic feet per minute, hour day, etc. Same as flow rate.

RATED FLOW: Normal operating flow rate at which a product is passed through a vessel; flow rate which a vessel and media designed to accommodate.

SEPARATION: The action of separating solids or liquids from fluids. May be accomplished by impingement, filtration, or by coalescing. The term "separation" is used in some circles when referring to the separation of liquids. Also used to describe the action in the second stage of two-stage separation.

SEPARATOR: A device whose primary function is to isolate contaminants by physical properties other than size.

SEPARATOR/FILTER: Vessel which removes solids and entrained liquids from another liquid or gas. Uses some combination of a baffle and/or coalescer, filter or separator element. May be single stage, two stage or single or two stage with prefilter section for gross solids removal. Common application is the removal of water from gas or another immiscible liquid. General reference to term applies the equipment is capable of both separation and filtration to specific degrees of efficiencies.

SERVICE LIFE: The length of time an element operates before reaching the maximum allowable pressure drop.

SURGE: The peak system pressure measured as a function of restricting or blocking fluid flow.

SLUDGE: Dirt, carbon, water and chemical compounds as found in oils.

TURBIDITY: Stirred up sediment or contaminant in a fluid.

SOLID SUSPENSION: A mixture of solids suspended in a fluid.

VACUUM: Reference to pressure below atmospheric.

SOLIDS: A mass, or matter, contained in a stream which is considered undesirable and should be removed.

VISCOSITY: Degree of fluidity; property of fluid's molecular structure by virtue of which they resist flow. The resistance of flow exhibited by a liquid resulting from the combined effects of cohesion and adhesion. The unit so f measurements are the poise and the stoke. A liquid has a viscosity of one poise if a force of one dyne per square centimeter causes two parallel liquid surfaces once square centimeter in area and one centimeter apart or move past once another at a rate of once centimeter per second. There are a great many rude and empirical methods for measuring viscosity which generally involve measurement for the time of flow or movement of a ball ring or other object t in a specially shaped or sized apparatus.

SURFACE AREA: Total area of an element that is exposed to approaching flow. See "percent free area".

AERATORS BUILT TO LAST



Our Troubled Waters...

Ponds and lakes, whether they are man made or natural, have a natural life cycle. They start out clean, fresh and clear, grow into middle age with weed and algae growth and high nutrient levels, and pass into old age as shallow bogs or marsh land. Before man began to impact the environment, this progression took hundred and even thousands of years. Ponds and lakes now can be created, live and die within decades. Why are the lives of our ponds and lakes so short? Much of the reason lies in the fact that water is our most abused, and least understood, natural resource.

Algae is a warning that a water quality problem exists. Sludge causes foul odors and depletes oxygen, killing fish and other beneficial aquatic life, and diminishing the water holding capacity of a pond. If left unchecked, a pond will not only become smelly and unsightly, but can gradually turn into a marshy swamp, and eventually into dry land.

Aeration is the key to keeping ponds and lakes functional and free from water quality problems. By bringing oxygen into the water and increasing the circulation, aeration naturally stimulates the water cleanup process and improves the overall quality of the aquatic ecosystem.

WE GIVE NATURE A BOOST

The dramatic increases in oxygen and circulation by Otterbine aerators speed up the biodegrading process of organic waste and fertilizer run-off. The added dissolved oxygen helps the bacteria in the pond or lake break down unpleasant odors and organic waste. The result is cleaner, odor free water.

CALL FOR ALL YOUR POND AND LAKE WATER SOLUTIONS

WATER TREATMENT

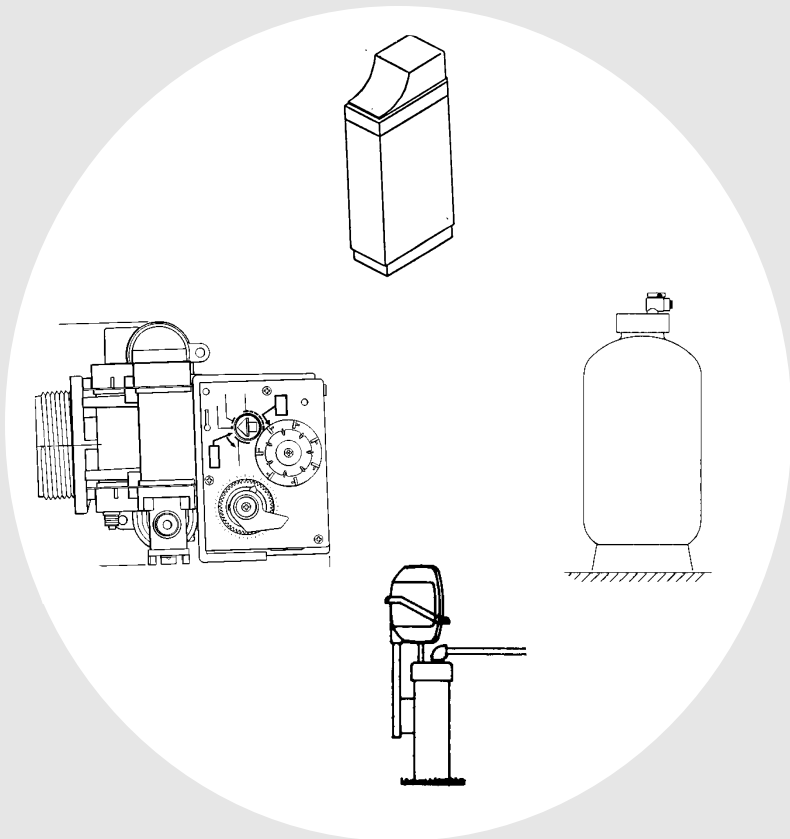

WATER TREATMENT

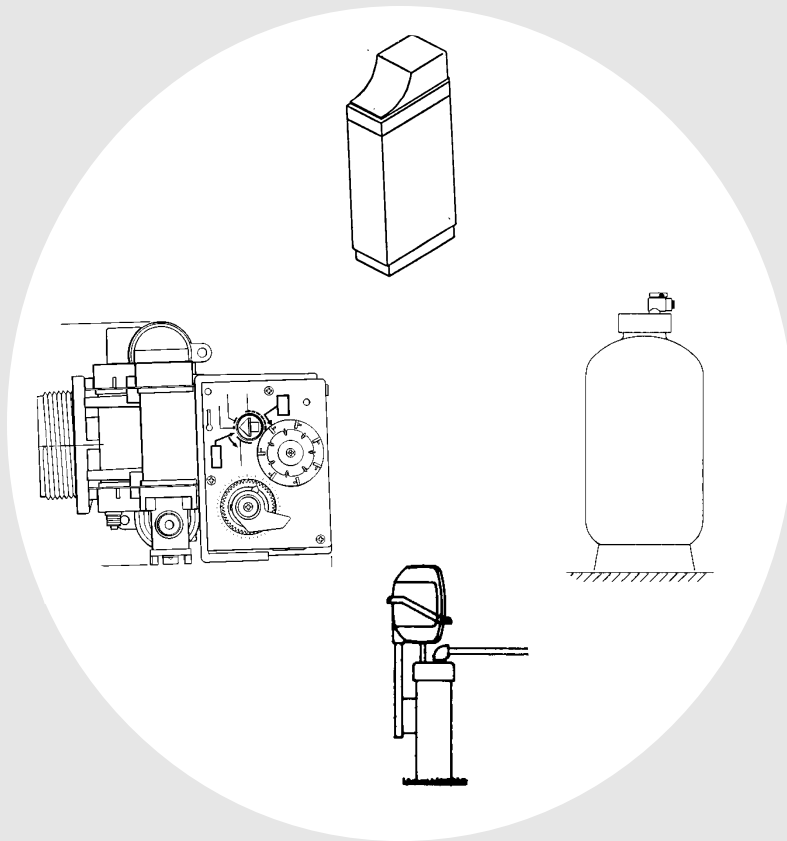



A DIVISION OF DUFF COMPANY
Products for Quality Water

Clearly Great Water Throughout Your Home

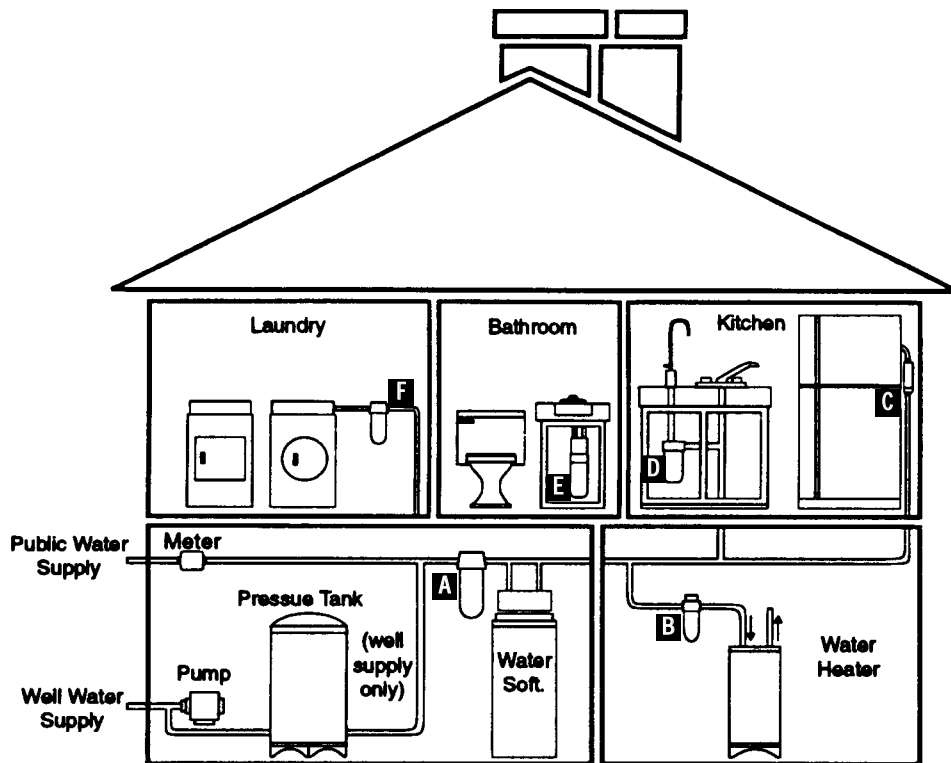

A WHOLE HOUSE SYSTEM

D DRINKING WATER SYSTEM

B HOT WATER SYSTEM

E UNDER-SINK FILTER

C ICE MAKER FILTER

F POINT-OF-USE FILTER

DWC OFFERS A VARIETY OF

Standard Blue Housings

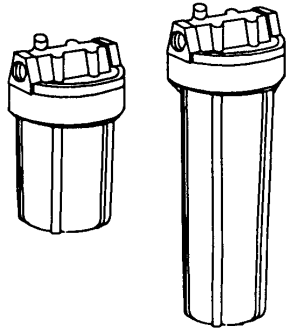

Standard blue housings are manufactured of polypropylene. Thick walls and multiple ribs make these housings ideal for industrial applications. The clean look, (FDA grade plastic) and light weight also makes them preferred in residential and commercial uses. Their polypropylene construction has excellent chemical resistance for use with most acids, alcohol, ammonia, oils, plating solutions, beverages and water. Mounting bracket cap with four screw bosses for rigid mounting installations.

MAXIMUM PRESSURE: 125 psi

MAXIMUM TEMPERATURE: 125°F

Clear Housings

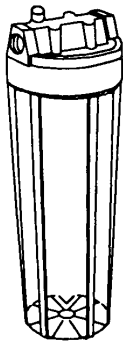

APPLICATIONS
 Food Processing
 Vending Equipment
 Food Service
 Main Line Residential Water
 Lab Equipment
 Photographic
 Slow Sight Indicators

The housing bodies are manufactured of clear FDA Styrene-Acrylonitrile (SAN) which has been stress relieved for added clarity and strength. Clear bodies offer on site examination of flow, cartridge performance and life. The SAN/Polypropylene construction combination has excellent chemical compatibility.(see chart for specific applications.

MAXIMUM PRESSURE: 125 psi

MAXIMUM TEMPERATURE: 125°F

CAUTION: Clear housing may crack or craze with time causing failure and leakage, if exposed to organic solvents such as those found in aerosol sprays for cleaning products and insecticides.

Blue Valve - In - Head Housings

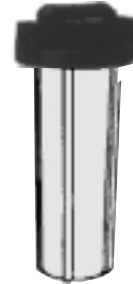

APPLICATIONS
 Photographic Equipment
 Std. DI Pre/Post Filtration
 Vending Machines
 Main Line Residential Water
 Safety Equipment
 Pre/Post Water Softeners
 Chillers
 Plating Recirculating Baths
 Lab Equipment
 Food Service
 Process Fluids
 Reverse Osmosis
 Hospital Equipment
 Laser Cooling Equipment

VIH housings incorporate the same rugged design and application features as standard 3/4" NPT housings. The internal VIH allows both inlet and outlet ports to be shut off internally simultaneously with a half turn of the handle. This eliminates the need for external shut-off valves, easing installation and cartridge change out. Radial sealing O-rings and sealing surfaces are continuously cleaned each time the valve is used, ensuring leak proof operation.

MAXIMUM PRESSURE: 125 psi

MAXIMUM TEMPERATURE: 125°F

Big Blue Housings

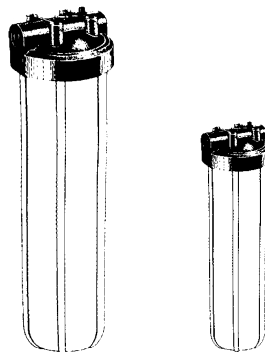

APPLICATIONS
 Water Wells
 Spas and Hot Tubs
 EDM Machines
 (Water Based)
 Plating
 Whole House
 Agriculture
 Drip Irrigation
 Green Houses

Big Blue Housings are manufactured of reinforced FDA grade polypropylene in both 10" and 20" lengths. The specifically designed High Flow Polypropylene (HFPP) cap is available with either a 1" or 1 1/2" NPT port. Four bosses are provided in each cap for mounting to either aluminum or 304 stainless steel "L" brackets. Big Blue Housings are ideal substitutes for costly low pressure stainless steel vessels. The larger body size allows for extra large cartridges and high flow rates. Polypropylene construction offers excellent chemical compatibility with water, beverages and syrups.

MAXIMUM PRESSURE: 10"=100 psi 20"=90 psi

MAXIMUM TEMPERATURE: 100°F

CARTRIDGES AND HOUSINGS BY MAJOR MANUFACTURERS INCLUDING



FILTER HOUSINGS TO CHOOSE FROM!

Hot/High Pressure

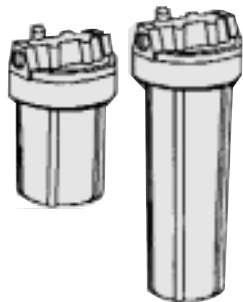

APPLICATIONS

- Hot Liquids
- Salt Water Fisheries
- Hot Water
- Toluene/Xylene
- Hydraulic Oils
- Alcohols
- Vegetable Oils
- Gasoline
- Photographic

The Hot/high Pressure filter housings are manufactured from glass reinforced nylon. Standard sealing and closure are achieved through the use of a 241 silicone O-ring. Housings are available in two lengths: 10" and 20". One cap style is available (standard cap, no pressure relief, no mounting bosses). Extra thick glass reinforced nylon construction allow these housings to be used on a wide range of temperatures and/or pressures. In addition, these housings are excellent for industrial applications involving organic solvent*, sea water, alcohol, petroleum and vegetable oils. High temperature/high pressure combination along with the excellent chemical compatibility makes these filter housings an economical alternative to stainless and carbon steel vessels. For detailed information call for our operating pressure vs. temperature chart.
*Avoid use with Ketones.

MAXIMUM PRESSURE: 200 psi
MAXIMUM TEMPERATURE: 200°F

Slim Line Housings

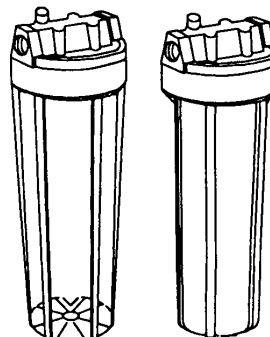

APPLICATIONS

- Low Flow OEM Equipment
- Recreational Vehicles
- Food Service Equipment
- Residential RO Systems
- Kidney Dialysis Equipment
- Humidifying Systems
- Temperature Control Valves

Slim Line Housings are manufactured of polypropylene. They are sealed with a top seated 237 Buna-N O-ring and Acme square thread closure. All caps come with four mounting bosses for rigid "L" bracket mounting. Slim Lines incorporate the same application and chemical resistance features as the standard 3/4" housings, but with a slimmer and shorter external design. Housings are designed to use the same cartridges as the 3/4" housings, but are designed for lower flow rates and conservation of space. Smaller overall diameter and port sizes make them ideal for multiple function applications when mounted in a series. Smaller vessels with the same capacity make them an economical choice.

MAXIMUM PRESSURE: 125 psi
MAXIMUM TEMPERATURE: 125°F

Slim Line Black Housings

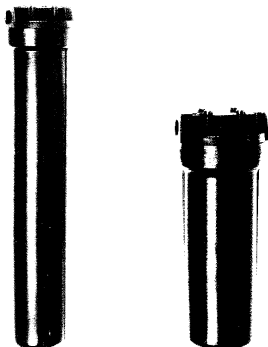

APPLICATIONS

- High Pressure RO
- Toluene/Xylene
- Hydraulic Oil
- Food Processing
- Gasoline
- Photographic Needs
- Paints/Inks
- Boiler Feedwater
- Alcohols

The Black Slim Line housings are manufactured from nylon which is reinforced with long glass fibers. Manufacturing the housings in this fashion increases strength and durability making them an ideal choice for various high pressure and corrosive applications*. Caps are molded with 1/2" inlet/outlet ports. Slim Line housings are available in two lengths: 10" and 20", with top-mount heads (no-pressure relief).
FDA Grade, Slim vessel design reduces space required for installation without sacrificing capacity, 200 psi rated, steam sterilizable, Designed for use with Resin-Bonded cartridges in dry cleaning, hydrocarbon, solvent and alkalis applications, Designed for use as 200 psi Reverse Osmosis Membrane Vessels (modification for brine port required).

*Avoid use with ketones. NOTE: Viton, silicone and Buna-N O-rings sold separately.
MAXIMUM PRESSURE: 200 psi **MAXIMUM TEMPERATURE:** 200°F

Pure Polypropylene Housings



APPLICATIONS

- Deionized and reagent grade water
- Electronic grade chemicals
- Reagent grade chemical
- Pharmaceutical grade solvents
- Reaction solvents for cosmetic, pharmaceutical for polyester production
- Most gases; nitrogen, argon ammonia
- Freons
- Electronic etching solutions
- Magnetic coatings (tape, disc or card)
- Reverse osmosis or ultrafiltration final filters
- Laboratory equipment

All natural, pure polypropylene filter housings can be used in an extremely wide variety of applications where purity, quality, minimal extractables and filtration economy are required. After your expensive cartridge, the last thing your liquid or gas is in contact with before going downstream is you filter housing. Use these all natural housings as added insurance against additional contamination.

PLASTIC FILTER HOUSINGS

MULTI-CARTRIDGE FILTER SYSTEMS

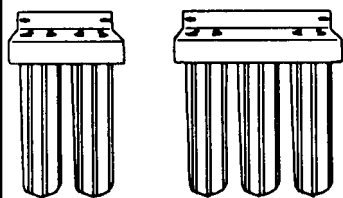

Multi-cartridge filtration systems contain multiple filter housings which are mounted in series. These systems offer a wide variety of filtration capabilities, depending upon your filter cartridge choice. They can use standard cartridges in 10" or 20" lengths, or large diameter cartridges.

The large body size allows for greater cartridge capacities and higher flow rates than are possible with standard size systems. Flow rates range up to 40 GPM, with pressure drops as low as 1 psi. The all-polypropylene construction offers excellent compatibility with water, beverages, syrups and a broad range of chemicals.

A P P L I C A T I O N S

HOME

Wholesale Filtration to reduce:
Rust, Iron, Sediment,
Taste/Odor, Chlorine

COMMERCIAL

Deionization, Coalescing
Combination, Sediment/Rust
Taste/Odor, Duplexing

INDUSTRIAL

Step-down filtration, Circulating Baths
Plating, Batch treatments, Color removal
Organic reduction, Cooling towers
Pre R.O. Filtration, Duplexing

H O U S I N G G U I D E

5" HOUSINGS - 4 7/8" CARTRIDGES

| DESCRIPTION | INLET/OUTLET | FLOW RATE (GPM) | FIG. NO. | PRICE |
|-------------|--------------|-----------------|----------|-------|
| Blue* | 3/8" | 1-5 | .9312 | |
| Clear* | 3/8" | 1-5 | .9314 | |

10" HOUSINGS - 9 3/4" TO 9 7/8" CARTRIDGES

| DESCRIPTION | INLET/OUTLET | FLOW RATE (GPM) | FIG. NO. | PRICE |
|-----------------------|--------------|-----------------|----------|-------|
| Slim Line Blue* | 3/8" | 1-7.5 | 48826 | |
| Slim Line Clear * | 3/8" | 1-7.5 | 44625 | |
| Blue * | 3/4" | 1-10 | 9309 | |
| Clear* | 3/4" | 1-10 | 38975 | |
| Red Hot/High Pressure | 3/4" | 1-10 | 9330 | |
| Black High Pressure | 3/4" | 1-10 | 150193 | |
| Black Valve-In-Head | 3/4" | 1-10 | - | |
| Clear Valve-In-Head* | 3/4" | 1-10 | 38977 | |
| Big Blue | 1 | 1-20 | 24484 | |
| Big Blue* | 1 1/2" | 1-25 | 23534 | |
| Natural Polypro | 3/4" | 1-10 | 150132 | |

20" HOUSINGS - 20 to 20 1/8" CARTRIDGES

| DESCRIPTION | INLET/OUTLET | FLOW RATE (GPM) | FIG. NO. | PRICE |
|-----------------------|--------------|-----------------|----------|-------|
| Blue* | 3/4" | 1-20 | 38976 | |
| Red Hot/High Pressure | 3/4" | 1-20 | 47089 | |
| Black High Pressure | 3/4" | 1-20 | 150194 | |
| Big Blue* | 1" | 1-40 | 43439 | |
| Big Blue* | 1 1/2" | 1-50 | 45378 | |
| Natural Polypro | 3/4" | 1-20 | 150135 | |

*Indicates pressure relief/bleed button on inlet side of cap. These items can be special ordered without the button.

SEDIMENT CARTRIDGES

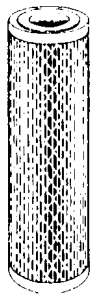

The S1 Series Paper Cartridges are designed for general water filtration purposes. Highly effective, yet economical, these cartridges remove sediment particles down to nominal 20 microns in size. The pleated construction of corrugated media, with over 4 sq. ft. per standard 9-3/4" cartridge, provides increased surface area and strength which results in extended life. An external netted sheath provides extra support to protect against system pulsation. End caps are fused to the cellulose media preventing bypass and forming a gasket sealing area.



The CRE-1 Series Ceramic Reusable Microstraining Cartridge is specially designed and tested for the reduction of Giardia and Cryptosporidium cysts from otherwise potable drinking water. The fine ceramic media will effectively trap dirt, sediment, and cysts down to one micron in diameter. In addition, the cartridges knife-edge and standpipe seal ensure a proper fit preventing water bypass.

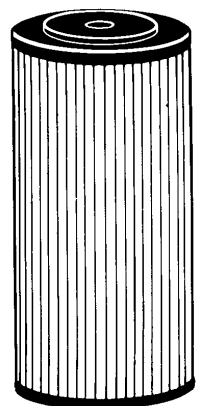

The R Series Reusable Paper Cartridges are made of a durable non-woven reusable polyester fabric which allows for several uses. The standard 9-3/4" length has more than four square feet, (sixteen square feet for the BBS models) of fabric media which has been pleated to maximize its dirt holding capacity and extend the time period between changes. The material is compatible with many chemicals, which makes them a good choice for light industrial water filtration. The synthetic construction makes them ideal for well water applications since they cannot be attacked by bacteria

NOTE: Reuse of cartridges is not recommended for drinking water applications.



The RBCM Series Resin Bonded Cartridge is produced from cellulose fibers, which have been intrinsically bonded together by a melamine resin, to create a solid, highly durable, yet porous structure. By treating the fibers in this fashion, we can assure a stronger cartridge that is less subject to collapse than any wound or pleated cartridge. Furthermore, the cartridge materials meet FDA specifications, making it completely safe for applications involving potable drinking water, beverages, cosmetics, syrups, etc.

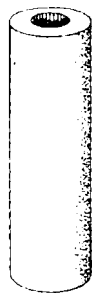

The P Series Spun Polypropylene Cartridges are made of 100% pure polypropylene fibers. The fibers have been carefully spun together to form a true gradient density from outer to inner surfaces. The coreless strength of the cartridge is achieved by sintering the many fibers into a solid matrix. Designed for purity, corrosion and chemical resistance with sizes (4 7/8 through 30") to handle most all industrial and commercial process fluids, these cartridges are still economical enough for home water use.

For additional information call: 610-275-4453 or Fax: 610-279-6299
Please call for current prices.



The WP Series String Wound Cartridge offers a wide chemical resistancy spectrum. They are compatible with most acids, alkalis, corrosive fluids, and gases. Polypropylene cord is wound around a polypropylene core in a precise pattern, ensuring a high efficiency rating as well as a high dirt loading capacity.

SEDIMENT CARTRIDGES



The HFCEP Series Pleated Cellulose Polyester Cartridges are designed for high flow industrial applications. These cartridges have approximately 8 square feet filtration area, double the square footage of standard cartridges: this correlates to double the life span before change outs. Smaller, more economical filter

housings can be used to obtain the same flow rate. This is most important for OEM's who do not have the space for larger vessels but still require high flows.



The WC25S Series High Temperature Cartridge is designed for high temperature applications. Cotton with a stainless steel core can withstand extremely high temperature without failure. The bleached cotton filtering media has been FDA approved, for safe filtering of hot water and beverages as well as distilled water, vegetable oils, petroleum, citric acid, fatty acid, and alcohols down to 1 micron.



The CP Series Pleated Cellulose Polyester Cartridges are the economical alternative to the industrial version. Approximately 4 square feet of pleated media and a polycore are immersed in a thermo-setting vinyl plastisol, embedding and sealing each end of the pleat block. Fusing of the three components in this fashion forms a unitized end cap and gasket.

EVERPURE



WATER TREATMENT PRODUCTS
ALWAYS AVAILABLE!

TASTE AND ODOR/SEDIMENT CARTRIDGES



GAC Series Granular Carbon Cartridges are designed for effective reduction of unwanted tastes and odors such as chlorine. They are engineered to allow water to enter the bottom and filter through the entire bed of carbon before exiting through the top. This allows the water to be in contact with the carbon for a maximum length of time, ensuring maximum adsorption.

An internal expansion pad maintains a tight compact column, minimizing channeling or bypass. A nominal 20 micron post filter is incorporated to reduce carbon fines and other suspended particles. *Cannot be coupled.*



The RFC Series Radial Flow Carbon Cartridges are designed for both liquid and gas filtration. For liquids, they are designed primarily for reducing organics and particulate contaminants for plating, acid, alkaline, and hydrocarbon solutions. The RFC can also be used for chlorine removal at low flow rates. For gas filtration, they are designed to remove chlorine gases, organics such as oil mist, water vapor and fine dust and scale particles. The activated carbon is a highly effective adsorption bed, while the inner layers remove particles over nominal 7 microns in size.



Products for Quality Water

TASTE AND ODOR/SEDIMENT CARTRIDGES

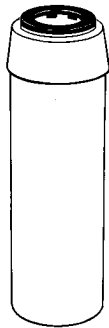

The **CC Series Coconut Carbon Cartridges** contain coconut shell-based activated carbon which is highly effective at reducing certain organic chemicals, such as, EDB, TCE, and THMs in addition to removing chlorine. A nominal 20 micron post filter is incorporated to reduce carbon fines and other suspended particles.

Cartridges are engineered to allow water to enter the bottom and filter through the entire bed of carbon before exiting throughout the top, ensuring maximum adsorption. *Cannot be coupled.*



The **SGAC Series Silver Impregnated Carbon Cartridge** is designed to effectively reduce tastes and odors such as those of chlorine, from potable drinking water supplies. The addition of silver helps to inhibit the internal growth of bacteria. The cartridge directs the water flow through the entrance at the bottom, and forces it upward through the bed of carbon before exiting through the post filter at the top. This method ensures that the water has maximum contact time with the carbon for greater effectiveness. *Cannot be coupled.*

Cartridges are engineered to allow water to enter the bottom and filter through the entire bed of carbon before exiting throughout the top, ensuring maximum adsorption. *Cannot be coupled.*



The **TSGAC Series Phosphate and Carbon Multi-purpose, Multi-media Cartridge** combines: granular activated carbon - for taste, odor, and chlorine reduction; phosphate crystals - for controlling rust stains and scale deposits; and a nominal 20 micron polypropylene post filter - for dirt, rust, and other suspended particle reduction. Triple protection for your water lines, fixtures, major appliances, and commercial equipment. *Cannot be coupled.*

Cartridges are engineered to allow water to enter the bottom and filter through the entire bed of carbon before exiting throughout the top, ensuring maximum adsorption. *Cannot be coupled.*



The **C1 and C2 Series Carbon Impregnated Cellulose Cartridges** are constructed from a carbon impregnated cellulose media. Combining the carbon and cellulose media in this fashion creates a dual purpose filter. In addition to filtering out fine sediment particles, it helps to reduce the unwanted tastes, odors, and chlorine often found in tap water and many industrial liquids. They are also excellent polishing filters when used in process or closed-loop streams.

Cartridges are engineered to allow water to enter the bottom and filter through the entire bed of carbon before exiting throughout the top, ensuring maximum adsorption. *Cannot be coupled.*

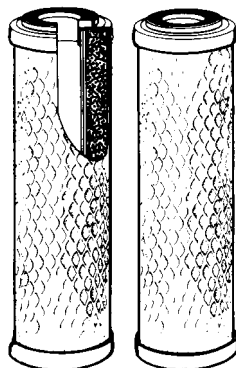

The **CBC Series Carbon Block Cartridges** are designed to reduce VOC's, chlorine, color bodies, as well as remove fine sediment from residential, commercial, and industrial liquids. The powdered activated carbon briquette provides high chemical adsorption, while the sediment filter eliminates unwanted particles down to .5 nominal micron. The CBC's make excellent polishing filter or prefilters for many applications.

Cartridges are engineered to allow water to enter the bottom and filter through the entire bed of carbon before exiting throughout the top, ensuring maximum adsorption. *Cannot be coupled.*

CARTRIDGES AND HOUSINGS BY MAJOR MANUFACTURERS INCLUDING



CARTRIDGE GUIDE

4 7/8" x 2 1/2" CARTRIDGES

SEDIMENT

| DESCRIPTION | MICRON | FIG. NO. | PRICE |
|--|--------|----------|-------|
| <i>P Series</i> Spun Polypropylene Cartridge | 5 | 51659 | |
| | 30 | 51059 | |
| <i>R Series</i> Reusable Paper Cartridge | 30 | 9323 | |

TASTE & ODOR

| | | | |
|---|----|-------|--|
| <i>GAC Series</i> Granular Carbon Cartridge | | 43556 | |
| <i>C2 Series</i> Carbon Impregnated Cellulose Cartridge | 5 | 9326 | |
| <i>CBC Series</i> Carbon Block Cartridge | .5 | 63080 | |

9 3/4" CARTRIDGES

SEDIMENT

| | | | |
|---|----|-------|--|
| <i>HFCP Series</i> Pleated Cellulose Polyester Cartridge | 1 | | |
| | 5 | | |
| | 10 | | |
| <i>CP Series</i> Pleated Cellulose Polyester Cartridge | 1 | 49700 | |
| | 5 | 48801 | |
| | 10 | 50225 | |
| <i>WC25S Series</i> High Temperature Cartridge | 1 | 44395 | |
| | 5 | 44396 | |
| | 30 | 44397 | |
| <i>P Series</i> Spun Polypropylene Cartridge | 1 | 59658 | |
| | 5 | 23535 | |
| | 25 | 43440 | |
| <i>R Series</i> Reusable Paper Cartridge | 30 | 48809 | |
| | 50 | 48810 | |
| <i>ST Series</i> Paper Cartridge | | 9322 | |
| <i>CRE-1 Series</i> Ceramic Reusable Microstraining Cartridge | | 46944 | |
| <i>RBCM Series</i> Resin Bonded Cartridge | .8 | | |
| | 1 | | |
| | 5 | 45190 | |
| | 10 | | |
| | 25 | | |
| <i>WP Series</i> String Wound Cartridge | 1 | 23539 | |
| | 5 | 44393 | |
| | 10 | 63676 | |
| | 20 | 49317 | |
| | 30 | 44394 | |
| | 50 | 47091 | |

TASTE & ODOR

| | | | |
|---|--|-------|--|
| <i>GAC Series</i> Granular Carbon Cartridge | | 23532 | |
| <i>CC Series</i> Coconut Carbon Cartridge | | 47024 | |
| <i>TSGAC Series</i> Phosphate and Carbon Multipurpose Multi-Media Cartridge | | 76404 | |
| <i>RFC Series</i> Radial Flow Carbon Cartridge | | 49381 | |
| <i>SGAC Series</i> Silver Impregnated Carbon Cartridge | | - | |
| <i>C1 Series</i> Carbon Impregnated Cellulose Cartridge | | 9325 | |
| <i>CBC Series</i> Carbon Block Cartridge | | 36477 | |
| <i>CBR2 Series</i> Carbon Briquet/Lead Reduction Cartridge | | 49382 | |

20" CARTRIDGES

SEDIMENT

| DESCRIPTION | MICRON | FIG. NO. | PRICE |
|--|--------|----------|-------|
| <i>ST Series</i> Paper Cartridge | 20 | 60290 | |
| <i>P Series</i> Spun Polypropylene Cartridge | 1 | 76463 | |
| | 5 | 23536 | |
| | 25 | 49228 | |
| <i>R Series</i> Reusable Paper Cartridge | 30 | | |
| <i>RBCM Series</i> Resin Bonded Cartridge | .8 | | |
| | 1 | | |
| | 5 | | |
| | 10 | | |
| <i>WP Series</i> String Wound Cartridge | 25 | | |
| | 1 | 43537 | |
| | 5 | 44399 | |
| | 20 | 49340 | |
| | 30 | 44400 | |

TASTE & ODOR

| | | | |
|--|--|-------|--|
| <i>GAC Series</i> Granular Carbon Cartridge | | 33533 | |
| <i>CC Series</i> Coconut Carbon Cartridge | | 83214 | |
| <i>RFC Series</i> Radial Flow Carbon Cartridge | | 52866 | |
| <i>CBC Series</i> Carbon Block Cartridge | | | |

9 3/4" x 4 1/2" FOR BIG BLUE HOUSINGS

SEDIMENT

| | | | |
|--|----|-------|--|
| <i>CP Series</i> Pleated Cellulose Polyester Cartridge | 5 | 47023 | |
| <i>R Series</i> Reusable Paper Cartridge | 30 | 47095 | |
| | 50 | 47096 | |
| <i>WP Series</i> String Wound Cartridge | .5 | 51058 | |
| | 1 | 62109 | |
| | 5 | 62106 | |
| | 10 | 62110 | |
| | 25 | 62111 | |
| | 30 | 58067 | |
| | 50 | 50531 | |

TASTE & ODOR

| | | | |
|--|--|-------|--|
| <i>GAC Series</i> Granular Carbon Cartridge | | 23533 | |
| <i>CBC Series</i> Carbon Block Cartridge | | 49775 | |
| <i>RFC Series</i> Radial Flow Carbon Cartridge | | 44865 | |

20" x 4 1/2" FOR BIG BLUE HOUSINGS

SEDIMENT

| | | | |
|--|----|-------|--|
| <i>ST Series</i> Paper Cartridge | 20 | 51239 | |
| <i>CP Series</i> Pleated Cellulose Polyester Cartridge | 5 | | |
| <i>R Series</i> Reusable Cartridge | 30 | | |
| <i>WP Series</i> String Wound Cartridge | 5 | 58068 | |

TASTE & ODOR

| | | | |
|---|--|-------|--|
| <i>NCP Series</i> Non Cellulose Pleated Cartridge | | 51473 | |
| <i>GAC Series</i> Granular Carbon Cartridge | | 44956 | |
| <i>CBC Series</i> Carbon Block Cartridge | | - | |
| <i>RFC Series</i> Radial Flow Carbon Cartridge | | 61207 | |

SPECIALTY FILTERS AND CARTRIDGES



The Nice-N-Icy Filter is designed to remove unpleasant tastes and odors as well as sediment to produce cleaner, clearer, better tasting ice cubes and ice water. This granular activated carbon filter is easily installed on the water line to an automatic icemaker or water dispensing system.

| SIZE | DESCR | FIG. NO. | PRICE |
|----------|-------------------------|----------|-------|
| 2" X 6" | White granulated carbon | 52359 | |
| 2" X 10" | White granulated carbon | 55624 | |



The PCC-1 Series Polyphosphate Cartridge contains a pure food grade phosphate that dissolves in water at a slow, controlled rate and imparts no taste or odor. The phosphate is highly effective at controlling rust and corrosion by forming a protective coating on the inside surface of piping and water heaters. Also, a small amount of soluble iron in a water supply may be treated, minimizing red water and iron staining. For use in standard 10" housing

NOTE: This cartridge will not fit the SLIM LINE housings.

| FIG. NO. | PRICE |
|----------|-------|
| 28989 | |

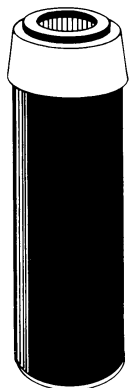

MIXED BED DEIONIZATION CARTRIDGES Due to the requirements of deionized water in many industries, we offer the PCF-Series mixed bed deionization cartridges. The FDA grade resin has been subjected to additional post-production steps to minimize the TOC (Total Organic Carbon) level. These high-capacity, semiconductor grade resin cartridges are ideal for use in pharmaceuticals, medical, laboratory, cosmetics, and circuit board printing applications. They may also be used in applications where water comes in contact with living organisms, such as fish breeding and potable water applications. and where low TOC and TDS (Total Dissolved solids) levels are required.

| SIZE | FIG. NO. | PRICE |
|---------------|----------|-------|
| 9 1/4 x 2 1/2 | 44957 | |
| 20 x 2 1/2 | 52300 | |
| 20 x 4 1/2 | 52301 | |

For additional information call: 610-275-4453 or Fax: 610-279-6299

Please call for current prices.



Hard Water/Iron Removal For those situations where you cannot install a large softener or filter, we offer cartridge filters to soften your water or to remove iron. These cartridges are filled with cation resin for softening or Manganese Greensand for iron removal.

| SIZE | MEDIA | FIG. NO. | PRICE |
|---------------------|---------------------|----------|-------|
| SOFTENING | | | |
| 9 3/4 x 2 1/2 | Cation Resin | 71472 | |
| 20 x 2 1/2 | Cation Resin | | |
| 20 x 4 1/2 | Cation Resin | | |
| IRON REMOVAL | | | |
| 9 3/4 x 2 1/2 | Manganese Greensand | 71594 | |
| 20 x 2 1/2 | Manganese Greensand | 47952 | |
| 20 x 4 1/2 | Manganese Greensand | 49811 | |

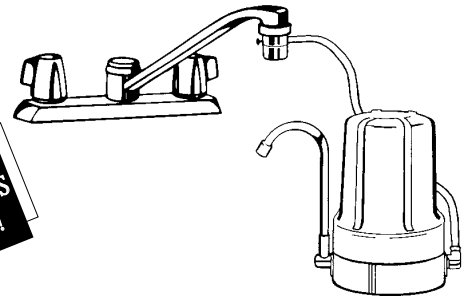

COUNTERTOP FILTER THE ECONOMICAL AND EASY-TO-INSTALL ALTERNATIVE FOR GREAT TASTING WATER! Portable, versatile and complete - each unit is individually boxed with diverter valve, supply line, dispenser faucet, base, sump and all fittings. All you add is the cartridge! (sink faucet not included).

*cartridge sold separately

| FIG. NO. | PRICE |
|----------|-------|
| 48657* | |

CHEMICAL CONTAMINANT FILTRATION SYSTEM

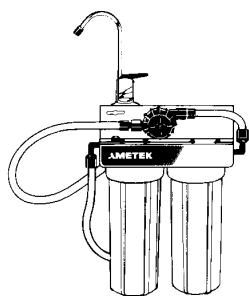

Effectively reduces DBCP, EDB, TCE, PCE, and THM;s. Also effectively reduces certain other chemicals from drinking water* -- plus sediment, taste and odor of chlorine, and other foul tastes and odors.

HERE'S HOW IT WORKS To achieve optimum chemical reduction, the flowing water must be in contact with the carbon for a prescribed length of time. A built-in flow controller allows for necessary contact time as water flows through our twin carbon cartridges. The carbon cartridges are effective through 1200 gallons of use, or about a full year for an average family. Our "Effective Life Indicator" monitors usage and automatically shuts off the water supply near 1200 gallons before the optimum effective life of the cartridges is exceeded, thus reminding the user to replace the cartridges.

*Must use 10" CC Series Cartridges

**System Comes with Cartridge

| FIG. NO. | PRICE |
|----------|-------|
| 25196 | |

ACCESSORIES

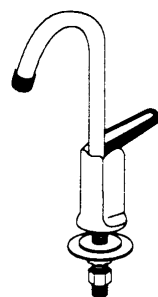

Touchflow Faucet

| DESCR | FIG. NO. | PRICE |
|------------|----------|-------|
| Std Reach | 23543 | |
| Long Reach | 44091 | |

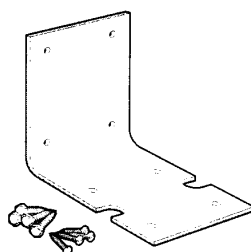

Bracket Kit

| APPLICATION | FIG. NO. | PRICE |
|-------------------------|----------|-------|
| Standard Housing (3/4") | 48418 | |
| Big Blue | 25968 | |
| Slimline (3/8"-1/2") | 44977 | |
| 2 Housing CCF & RO | 44975 | |
| 3 Housing CCF & RO | 44976 | |

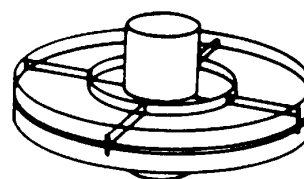

Cartridge Coupler

| APPLICATION | FIG. NO. | PRICE |
|--------------------|----------|-------|
| Std Cartridge | 44866 | |
| Big Blue Cartridge | 47072 | |

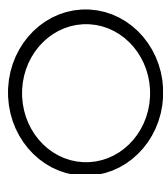

Buna O-Rings

| APPLICATION | FIG. NO. | PRICE |
|----------------------|----------|-------|
| 10" or 20" Housing | 9329 | |
| Big Blue Housing | 44970 | |
| Slimline (3/8"-1/2") | 44978 | |

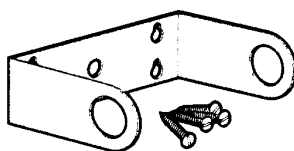

3/4" U-Bracket Kit

| FIG. NO. | PRICE |
|----------|-------|
| 9328 | |

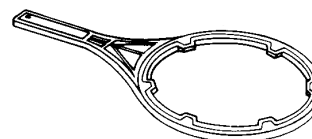

Wrench

| APPLICATION | FIG. NO. | PRICE |
|-------------------------|----------|-------|
| Standard Housing (3/4") | 23538 | |
| Big Blue Housing | 25807 | |
| Slimline (3/8"-1/2") | 47073 | |
| Big Blue Sump Wrench | 58904 | |

**STAINLESS STEEL HOUSINGS AND
MULTI-CARTRIDGE VESSELS**

*Ideal for commercial and residential * Typical applications *
Pharmaceutical * Food products * Photographic * Water * Compressed Air
* Liquid Fuels * Paints * Petrochemicals * Schools * Restaurants *
Farms * Institutions*

| FIG. NO. | MODEL # | RATED CAP | MAX OPER PRESS | HGHT | DIA | # OF 10" CART | PIPE SIZE (npt) | SHIP WT |
|----------|---------|-----------|----------------|---------|-----|---------------|-----------------|---------|
| 28986 | ST-1 | 10 GPM | 250 | 12-7/8" | 4" | 1 | 3/4" | 7 |
| 43644 | ST-2 | 15 GPM | 250 | 22-3/4" | 4" | 2 | 3/4" | 10 1/2 |
| | ST-BC4 | 20 GPM | 125 PSI | 21" | 10" | 4 | 1 1/2" | 20 |
| | ST-BC8 | 56 GPM | 125 PSI | 31" | 10" | 8 | 2" | 30 |
| | ST-BC12 | 84 GPM | 125 PSI | 42" | 10" | 12 | 2" | 40 |
| | ST-BC16 | 110 GPM | 125 PSI | 52" | 10" | 16 | 2" | 50 |
| | ST-BC20 | 140 GPM | 125 PSI | 52" | 10" | 20 | 2" | 50 |

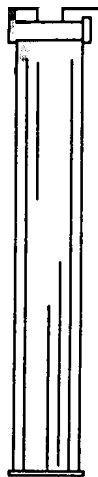

ST SERIES

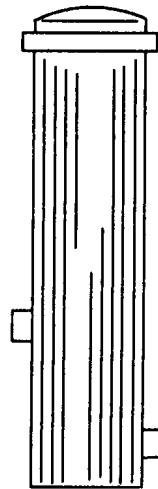

ST-BC SERIES

Above rated flow capacities based on sediment removal with a 25-micron rated filter cartridge for taste/odor removal. Standard housing gasket is Buna-N. Other materials on request. Prices do not include cartridges.

Cartridge lengths on SS housing only: 10"=9 3/4"; 20: = 19 1/2" 30"=29 1/4" 40"=39"

**Pressure rated to 300° F



Products for Quality Water

HARMSCO UP-FLOW CARTRIDGE FILTRATION

A Design So Superior It's Patented!

Harmsco's up-flow design out performs conventional filters! Fluid enters the filter under pressure and flows through the filter media, holes in the center tubes and perforations in the rods that hold the cartridges in place. As the fluid continues its path, it flow upward past the top seal where it spills over into the standpipe as it hits the filter's domed lid. The top of the standpipe is at the high point of the filter. Also, note the the filter cartridges are sealed at the bottom and held in place with threaded pipe caps.

UP-FLOW Stainless Steel Industrial "filter Housings

Cartridge filters (304 stainless steel, CPVC standpipes, CPVC cartridge holders and threaded caps)

Cartridge cluster filters (to remove entire set of cartridges at one time for cleaning or replacement)

***No Air Entrapment**

***No Vents**

***No Fluid By-Pass**

During Servicing

***Electro-Polished**

***Fail-Safe Lids**



Cartridge cluster filter with easy cartridge removal for cleaning or replacement.



| | HIF-7 | HIF-14 | HIF-16 | HIF-21 | HIF-24 |
|------------------------|------------------|------------------|------------------|-----------|------------------|
| Flow rate (GPM) | Up to 30 | Up to 60 | Up to 75 | Up to 90 | Up to 105 |
| No. of Std. Cartridges | 7 | 14 | 16 | 21 | 24 |
| Alternative cartridge | Single Only | 7 doubles | 8 doubles | 7 triples | 8 triples |
| Pipe size (Male NPT) | 1 1/2" | 1 1/2" | 2" | 1 1/2" | 2" |
| Filter Height | 19.5" | 28" | 28" | 37" | 37" |
| Floor Space Req'd | 13"x13" | 13"x13" | 13"x13" | 13"x13" | 13"x13" |
| Service hght clearance | 35" | 48" | 48" | 68" | 68" |
| Shipping wght (appx) | 29 lbs. | 39 lbs. | 39 lbs. | 50 lbs. | 50 lbs. |
| Pressure rating | 150 psi | 150psi | 150 psi | 150 psi | 150 psi |
| FIG. NO. | 5 1 2 4 0 | 5 8 4 9 5 | 5 8 4 9 6 | - | 5 5 9 3 6 |

Large capacity filters with cartridge filters for easy cartridge removal

***Compact Design**

***Pressure Rated to**

150 psi

***Cartridge Cluster**

Filters



Large capacity filter with lifting rods to remove a single stack of cartridges at a time.



| | HIF-42 | HIF-75 | HIF-100 | HIF-150-FL | HIF-200-FL |
|------------------------|------------------|------------------|------------|------------|-------------|
| Flow rate (GPM) | Up to 175 | Up to 300 | Up to 400 | Up to 600 | Up to 800 |
| No. of Std. Cartridges | 42 | 75 | 100 | 150 | 200 |
| Alternative cartridge | 14 triples | 25 triples | 50 doubles | 50 triples | 100 doubles |
| Pipe size (Male NPT) | 2" | 3" | 3" | 4" flanged | 4" flanged |
| Filter Height | 40" | 42" | 52" | 48" | 58" |
| Floor Space Req'd | 18"x18" | 20"x20" | 20"x20" | 28"x28" | 28" x 28" |
| Service hght clearance | 68" | 70" | 87" | 76" | 93" |
| Shipping wght (appx) | 100 lbs. | 129 lbs. | 188 lbs. | 274 lbs. | 321 lbs. |
| Pressure rating | 150 psi | 150 psi | 150 psi | 150 psi | 150 psi |
| FIG. NO. | 6 9 9 3 5 | 6 6 8 6 7 | - | - | - |

NOTE: Wing-nuts standard for lid closure with no tools required. Filters rated for temperatures to 140°F (60°C) with standard Harmsco cartridges and 200°F (93°C) with high-temp cartridges. Limits vary and depend on pressure and time under load.

HARMSCO REPLACEMENT FILTER CARTRIDGES

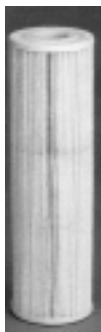

| NOMICAL MICRON | P R O D U C T C O D E | | | | | END CAP COLOR |
|----------------|-----------------------|----------|------------------|--------|--------|---------------|
| | SINGLE/REGULAR | FIG. NO. | SINGLE/HIGH TEMP | DOUBLE | TRIPLE | |
| .035 | 801-0.35 | 66528 | ---- | ---- | ---- | Brown |
| 1 | 801-1 | 61568 | 801-1-HT | 921-1 | 931-1 | Tan |
| 5 | 801-5 | 66529 | 801-5-HT | 921-5 | 931-5 | White |
| 10 | 801-10 | 64139 | ---- | 921-10 | 931-10 | Red |
| 20 | 801-20 | 60464 | 801-20-HT | 921-20 | 931-20 | Blue |
| 50 | 801-50 | 66530 | 801-50-HT | 921-50 | 931-50 | Yellow |
| 100 | 801-100 | 51397 | ---- | ---- | ---- | Green |

WaterBetter™ FILTER CARTRIDGES WITH APPROXIMATELY FOUR SQ. FT. OF MEDIA PER 9 3/4" LENGTH - ECONOMICAL CARTRIDGES FOR ALL APPLICATIONS.

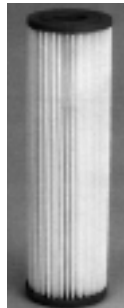

| NOMICAL MICRON | P R O D U C T C O D E | | | | END CAP COLOR |
|----------------|-----------------------|----------|---------------|---------------|---------------|
| | SINGLE LENGTH | FIG. NO. | DOUBLE LENGTH | TRIPLE LENGTH | |
| 1 | WB-1 | 66533 | WB-921-1 | WB-931-1 | Tan |
| 5 | WB-5 | 66534 | WB-921-5 | WB-931-5 | White |
| 20 | WB-20 | 66535 | WB-921-20 | WB-931-20 | Blue |
| 50 | WB-50 | 66536 | WB-921-50 | WB-931-50 | Yellow |

HARMSCO FILTER OPTIONS

Standard cartridge filters are available with the following options to meet your specific filtration applications.

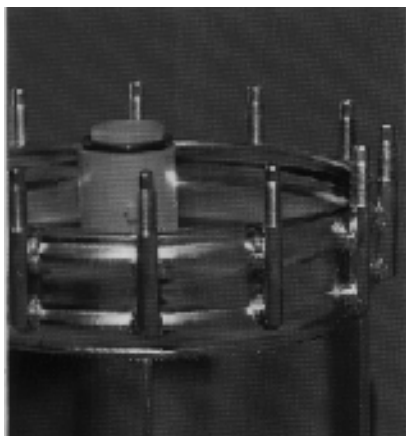

HIGH TEMPERATURES: Filters with standpipes made of CPVC and special cartridges are available for high temperature applications to 200oF. Available for all standard models and 1,5,20 and 50 micron filter cartridges. (not available on Hurricane filters.) For additional information call: 610-275-4453 or Fax: 610-279-6299 Please call for current prices.



CHEMICAL RESISTANCE: Filters with high performance coatings are available for increased resistance to chemicals, abrasion and the environment. Fluoropolymer coating applied to all 304 stainless steel surfaces (inside and out.)



SWING-BOLT MODELS: heavy duty filters with swing-bolt closure and six eye-nuts for quick access to cartridge cluster for easy cartridge replacement or cleaning are available for sixteen and twenty-four cartridges. Rated for pressures to 150 psi.

THE REVOLUTIONARY HARMSCO HURRICANE

COMBINES THREE FILTRATION TECHNOLOGIES IN A SINGLE COMPACT DESIGN

CENTRIFUGAL SEPARATION TO REMOVE DENSE PARTICLES FROM LIQUIDS

Liquid enters the Hurricane filter's outer chamber tangentially, producing a rotational flow. This flow pattern creates a centrifugal force which is used to separate dense particles such as sand, rust, grit and metal filings from liquids. Heavy particles drop to the bottom of the filter's outer chamber where they are discharged manually, automatically or continuously. With the dense particles removed, liquid and light solids rise up, over and into an inner chamber where the rotational flow is continued.

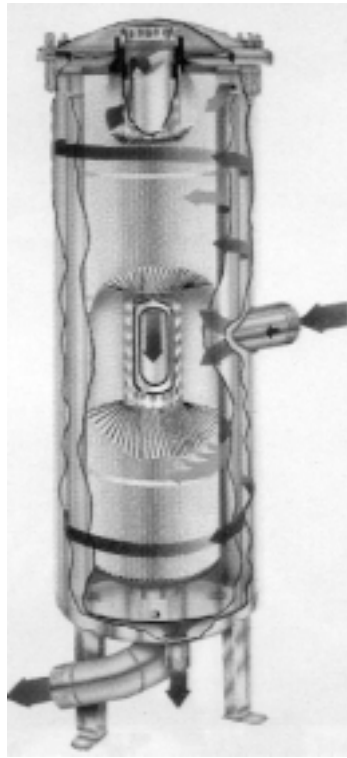

UP FLOW CARTRIDGE FILTRATION AND ANGLES PLEATS FOR LIGHT-WEIGHT PARTICLE REMOVAL

Lighter solids are removed in the filter's inner chamber by a proprietary filter cartridge made with deep, angled pleats which are directed toward the liquid's rotational flow. As forces of the liquid collide with the cartridge, the pleats 'flutter' which distributes particulate evenly within the pleated area. Filter efficiencies are dramatically improved to provide longer filter runs and reduced filtration costs. Hurricane filter elements are available in a wide range of micron ratings and may be cleaned and reused in most applications and most micron rating.

THREE MODELS AVAILABLE

Three Harmsco Hurricane Filter models are available for a wide range of applications. Hurricane filters are rated for pressures to 150 psi, temperatures to 140°F and can separate solids in liquids with a pH of 3 to 11.

FEATURES AND SPECIFICATIONS

- *304 stainless steel filter housings
- *Electro polished for superior finish
- *Resistant coating available
- *Fail-safe lids with individual studs for security
- *Bronze wing-nuts for convenience
- *90° elbow and 45° sweep on outlet for in-line vertical installation
- *CPVC standpipe for up-flow design
- *Choice of cartridges not included



**FILTER AND
CARTRIDGE
SOLD
SEPARATELY**

| | HUR-40-HP | HUR-90-HP | HUR-170-HP |
|------------------------|-----------|-----------|------------|
| Flow rate (GPM) | Up to 50 | Up to 100 | Up to 200 |
| No. of Std. Cartridges | 40 | 90 | 170 |
| Alternative cartridge | 2" | 2" | 2" |
| Pipe size (Male NPT) | 1" | 1" | 1" |
| Filter Height | 21" | 31" | 41" |
| Floor Space Req'd | 13" | 13" | 13" |
| Service hght clearance | 15"x15" | 15"x15" | 15"x15" |
| Shipping wght (appx) | 31" | 51" | 72" |
| Pressure rating | 40 lbs | 51 lbs | 64 lbs |
| FIG. NO. | 6 0 7 1 5 | 6 7 4 4 8 | - |



HARMSCO HURRICANE REPLACEMENT CARTRIDGES

Made of pleated polyester for long life and high dirt capacity.

Cleanable and reusable in most applications; rated for 140°F.

| FILTER NUMBER | CARTRIDGE NUMBER | MICRONS | FIG. NO. | PRICE |
|---------------|------------------|---------|----------|-------|
| HUR-40-HP | HC-40-0.35 | .35 | 60716 | |
| HUR-40-HP | HC-40-1 | 1 | | |
| HUR-40-HP | HC-40-5 | 5 | | |
| HUR-40-HP | HC-40-20 | 20 | | |
| HUR-40-HP | HC-40-50 | 50 | | |
| HUR-40-HP | HC-40-100 | 100 | | |
| HUR-90-HP | HC-90-0.35 | .35 | | |
| HUR-90-HP | HC-90-1 | 1 | | |
| HUR-90-HP | HC-90-5 | 5 | 74027 | |
| HUR-90-HP | HC-90-20 | 20 | 67451 | |
| HUR-90-HP | HC-90-50 | 50 | | |
| HUR-90-HP | HC-90-100 | 100 | | |
| HUR-170-HP | HC-170-0.35 | .35 | | |
| HUR-170-HP | HC-170-1 | 1 | | |
| HUR-170-HP | HC-170-5 | 5 | 67748 | |
| HUR-170-HP | HC-170-20 | 20 | | |
| HUR-170-HP | HC-170-50 | 50 | | |
| HUR-170-HP | HC-170-100 | 100 | | |

BAG FILTERS

HARMSCO STAINLESS BAG FILTERS



Select Harmsco's high capacity BetterBag filters when more precise cartridge filtration is not required. Special features include electro-polished stainless steel, 18 gauge stainless steel basket to accommodate large #2 filter bag, easy wing nut lid closure and compact design. Models include:

| PRODUCT CODE | DESCRIPTION | PIPE SIZE | MAX. FLOW RATE | SHIPPING WT. |
|--------------|-------------------------------|-----------|----------------|--------------|
| BBHP | Stainless with CPVC standpipe | 1 1/2" | 100 GPM | 50 lbs. |
| BBHP-SS | All stainless steel | 1 1/2" | 100 GPM | 52 lbs. |
| BBHP-2 | All stainless steel | 2" | 150 GPM | 54 lbs. |

| FILTER BAG | MATERIAL | NOM.MICRON | FILTER BAG | MATERIAL | NOM.MICRON |
|------------|----------------|------------|------------|---------------|------------|
| HIF-PF-5 | Polyester Felt | 5 | HIF-PP-50 | Polypropylene | 50 |
| HIF-PF-25 | Polyester Felt | 25 | HIF-PP-100 | Polypropylene | 100 |
| HIF-PF-50 | Polyester Felt | 50 | NMO-100 | Nylon Mesh | 100 |
| HIF-PF-100 | Polyester Felt | 100 | NMO-200 | Nylon Mesh | 200 |

BAG FILTERS

AMETEK PLASTIC BAG FILTERS



BAG FILTER HOUSINGS

| DESCR | SIZE | FIG. NO. |
|----------------|--------|----------|
| 10" Bag Vessel | 1" | |
| 10" Bag Vessel | 1 1/2" | |
| 20" Bag Vessel | 1 1/2" | |
| 20" Bag Vessel | 1" | |

FILTER BAGS

| SIZE | MICRON | FIG. NO. | SIZE | MICRON | FIG. NO. |
|------|--------|----------|------|--------|----------|
| 10" | 1 | | 20" | 25 | |
| 20" | 1 | | 10" | 50 | |
| 10" | 5 | | 20" | 50 | |
| 20" | 5 | | 10" | 100 | |
| 10" | 10 | | 20" | 100 | |
| 20" | 10 | | 10" | 200 | |
| 10" | 25 | | 20" | 200 | |

HAYWARD ALL PLASTIC BAG FILTERS

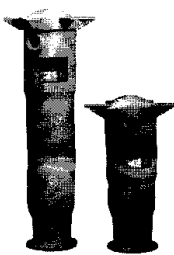

BAG FILTERS. All bags filters feature a one piece, seamless, molded plastic body and have Viton seals.

POLYPROPYLENE-Simplex bag filters use single length 7"x16" No. 1 bags or double length 7"x 32" No. 2 bags

| SIZE | END CONNECTION | PART NO. | PRICE |
|---------------|----------------|----------|-------|
| Single Length | 2" Threaded | FLT4201 | |
| Single Length | 2" Flanged | FLT4201F | |
| Double Length | 2" Threaded | FLT4202 | |
| Double Length | 2" Flanged | FLT4202F | |

FILTERS AND BAGS SOLD SEPARATELY

PVDF WITH VITON SEALS

| SIZE | END CONNECTION | PART NO. | PRICE |
|---------------|----------------|----------|-------|
| Double Length | 2" threaded | FLT5202 | |

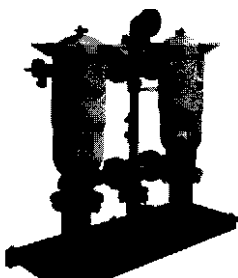

DUPLEX BAG FILTERS. Duplex bag filters do not have to be shut off for bag change out.

POLYPROPYLENE HOUSING WITH CPVC DIVERTER VALVES

| SIZE | END CONNECTION | PART NO. |
|---------------|----------------|----------|
| Single Length | 2" Flanged | FLT1DUP |
| Double Length | 2" Flanged | FLT2DUP |

REPLACEMENT FILTER BAGS. Hayward filter bags are manufactured from non-woven polypropylene felt. The bags are individually plastic wrapped and sealed to prevent contamination in shipping and handling. Sold in master cartons of 24 bags.

| SINGLE LENGTH (7" x16") Filter Bags | | | DOUBLE LENGTH (7" x32") Filter Bags | | |
|-------------------------------------|----------|-------|-------------------------------------|-----------|-------|
| SIZE | PART NO. | PRICE | SIZE | PART NO. | PRICE |
| 1 MICRON | FB331001 | | 1 MICRON | FB332001 | |
| 5 MICRON | FB331005 | | 5 MICRON | FB332005 | |
| 10 MICRON | FB331010 | | 10 MICRON | FB332010 | |
| 25 MICRON | FB331025 | | 25 MICRON | FB332025 | |
| 50 MICRON | FB331050 | | 50 MICRON | FB332050 | |
| 100 MICRON | FB331100 | | 100 MICRON | FB332100 | |
| 200 MICRON | FBM31200 | | 200 MICRON | FBM332200 | |

RUSCO SPINDOWN SEDIMENT FILTERS

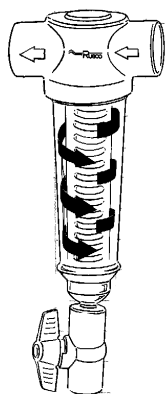

Clear cover is easily removed for total cleaning (no tools required)*
 Flow capacity for entire system
 Sediment is visible through clear cover indicating when the filter needs cleaning
 Sediment is quickly and easily removed by opening the optional ball valve at the bottom of the filter cover
 Reusable polyester and stainless steel filter screen in many mesh sizes
 No down time
 Made in USA
 *Using tools void warranty

RUSCO SPINDOWN SEDIMENT TRAPPER FILTERS

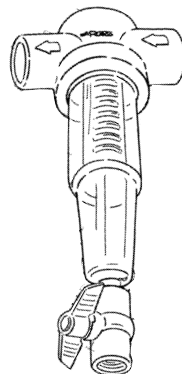

Unique element design traps sediment in lower reservoir of clear cover
 Clear bowl easily removed for total cleaning (no tools required)*
 Flow capacity for entire system
 Sediment is visible through the clear cover indicating when the filter needs cleaning
 No down time
 Optional ball valve allows for quick sediment removal from bottom of cover
 Centrifuge spin-down type sediment separation
 Reusable polyester and stainless steel filter screen available in many mesh sizes from very fine to very coarse
 *Using tools void warranty

| SPINDOWN FILTER | | |
|-----------------|----------|-------|
| SIZE | FIG. NO. | PRICE |
| 3/4" | 48478 | |
| 1" | 44243 | |
| 1 1/2" | 31887 | |
| 2" | 43711 | |

| SEDIMENT TRAP FILTER | |
|----------------------|-------|
| FIG. NO. | PRICE |
| 83589 | |
| 44609 | |
| 83590 | |
| 83591 | |

| SPINDOWN FILTER SCREENS | | | |
|-------------------------|------|----------|-------|
| SIZE | MESH | FIG. NO. | PRICE |
| 1" | 24 | 48477 | |
| 1" | 40 | 50966 | |
| 1" | 100 | 48458 | |
| 1" | 140 | 50512 | |
| 1" | 250 | 49384 | |
| 1" | 500 | 44610 | |
| 1" | 1000 | 44611 | |
| 1 1/2" | 24 | 54011 | |
| 1 1/2" | 100 | 49383 | |
| 1 1/2" | 250 | 38062 | |
| 2 | 24 | 53252 | |
| 2 | 60 | 48827 | |
| 2 | 100 | 48480 | |
| 2 | 250 | 69438 | |
| 2 | 500 | 48479 | |

| MATERIAL IN WATER | APPLICATIONS | USE MESH NUMBER |
|-----------------------------------|---|------------------------------|
| 1. Shale, shell | General use | 24 |
| 2. Debris | General use | 24,30,40 |
| 3. Pipe scale, coarse sand | Sprinkler systems, faucet aerators, sand sensitive valve | 40 to 60 |
| 4. Fine sand, grit from new wells | Drip irrigation systems, faucet aerators, sand sensitive valves | 100 to 140 |
| | Poultry growers watering devices (.010") | 100(.006" opening) |
| 5. Very fine sand and grit | Fogger nozzles | 140 (.004" opening) |
| | Pre-treatment | 250 to 500 |
| | Pre-treatment ultra water systems RO, etc. | 1000 |
| 6. Algae | Grows in presence of light under clear filter cover. | Use solid white filter cover |



Honeywell Braukmann THE WORLD'S FINEST PREFILTER

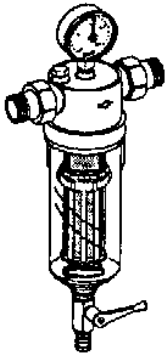

- *Quick in-line cleaning without disassembly
- *No shut off required during backwash cycle
- *Built-in secondary filter provides an uninterrupted supply of filtered water during backwashing
- *Internal bypass construction eliminates stagnant water in seldom used bypass lines
- *Patented impeller cleaning system backwashes the filter with a 'pulsating' high pressure stream directed through the filter screen.
- *Flow and filtering capacity to service an entire plumbing system - not just a single fixture

TYPICAL APPLICATIONS

Private wells, municipal water, recreational home water, lake water, irrigation system, industrial process water, protection of sensors for pressure, flow, chemicals or temperature.

*Protection of solenoid valves, protection of water source heat pumps, precipitate removal from chemical water treatment systems, drinking fountains, soda vending machines, etc.

Each filter has double union threaded connections, with transparent sump, 100 micron screen, and pressure gauge. 104 deg. F, 230 psi maximum

| SIZE | FIG. NO. | PRICE |
|--------|----------|-------|
| 1/2" | 83579 | |
| 3/4" | 83580 | |
| 1" | 83581 | |
| 1 1/4" | 83484 | |
| 1 1/2" | 83585 | |
| 2" | 80833 | |

LAKOS SandMaster

HOW TO SELECT YOUR SANDMASTER MODEL

Each Sandmaster model operates best within a specific flow range. To determine your pump's actual flow rate:

If you have a valve between the pump and the pressure tank, open it fully and record the volume of water in one minute to determine gallons or liters per minute.

If you have no valve, follow these simple steps.

1. Immediately after your pump shuts off, open faucet between pressure tank and house (make sure no the water is running), run water into a container and record the **volume** (gallon or liters) of water it takes for pump to start up again. (you may have to refill container several times).
2. Record length of **time** (in minutes) pump runs before shutting off again.
3. Divide **volume** by **time** to determine actual flow rate (gpm or liters/minute).
4. Select your Sandmaster model accordingly.

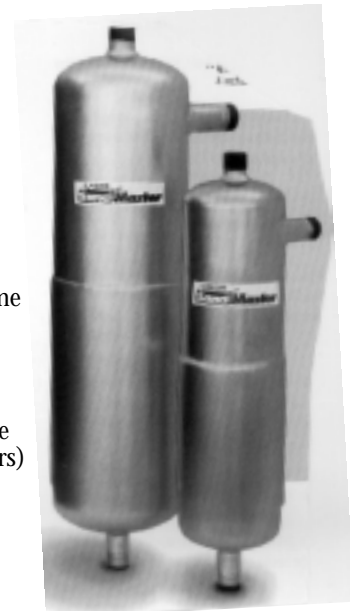

| US GGPM | SANDMASTER MODEL | FIG. NO. | INLET/OUTLET PIPE SIZE MALE, NPT | DIMENSIONS | |
|---------|------------------|----------|----------------------------------|------------|----------|
| | | | | HEIGHT | DIAMETER |
| 5-10 | H20-5 | 64298 | 1/2 inch | 19 3/8" | 4 1/2" |
| 10-20 | H20-10 | 51394 | 3/4 inch | 19 3/8" | 4 1/2" |
| 20-32 | H20-20 | 60507 | 1 inch | 24 3/4" | 6" |
| 30-48 | H20-30 | 60508 | 1 1/4 inch | 24 3/4" | 6" |
| 45-70 | H20-45 | 52404 | 1 1/2 inch | 24 3/4" | 6" |

ALL OTHER LAKOS PRODUCTS READILY AVAILABLE!





WATER FILTRATION PRODUCTS



A DIVISION OF DUFF COMPANY
Products for Quality Water



AP101S
Dirt/Rust Water Filter.
With shut off valve in head.
Installs on incoming water line.



AP101T
Dirt/Rust Water Filter.
With shut off valve in head.
Installs on incoming water line.

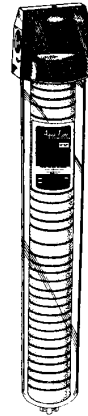

AP102T
Dirt/Rust Water Filter.
For cold water use only.



AP11T
Dirt/Rust Water Filter.
For cold water use only.



AP11S
Dirt/Rust Water Filter.
For cold water use only.



AP12T
Dirt/Rust Water Filter.
For cold water use only.



AP1610
Heavy Duty Water Filter.
Install on incoming water
line or under the sink.

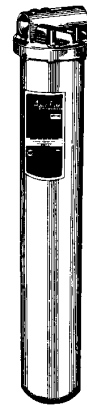

AP2610
Dirt/Rust Water Filter.
Heavy Duty Water Filter.
Install on incoming water line
or under the sink.

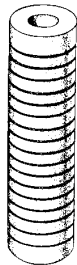

AP110 H/C
AP111 H/C
AP124 H/C
Dirt/Rust Water Filter Cartridge



AP420
Blue Green Stain, Scale corrosion.
Water Filter Cartridge



AP430
Hot Water System Protector.



AP431
Hot Water System Protector.
Water Filter Cartridge



A DIVISION OF DUFF COMPANY
Products for Quality Water

WATER
FILTRATION
PRODUCTS



AP51T
Dirt/Rust/Taste/Odor
Water Filter.
Installs under sink.



AP117
Taste/Odor
Water Filter.



AP217
Dirt/Rust, Taste/Odor
Water Filter. Cartridge.
For AP200.



AP200
Dirt/Rust, Taste/Odor
Water Filter.
Installs under sink.



AP500
Dirt/Rust, Taste/Odor,
Scale Inhibitor Water
Filter.



AP517
Dirt/Rust, Taste/Odor,
Scale Inhibitor Water
Filter Cartridge.



AP717
Ice Maker in Water Filter.



AP305
Dirt/Rust, Taste/Odor, Scale
Water Filter. Installs on vending machines,
coffee makers and fountains. Home
ice makers.



AP300
Dirt/Rust, Taste/Odor,
Scale Water Filter.



AP317
Scale Water Filter
Cartridge



AP450
Scale Stopper Water Filter
Cartridge. Installs on water
using appliances.



AP617
Dirt/Rust, Taste/Odor,
Scale Inhibitor Water
Filter Cartridge.

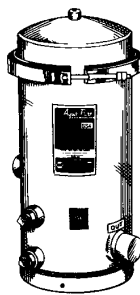

SS4
Commercial Duty
Filter System.

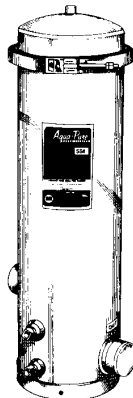

SS8
Commercial Duty
Filter System.



SS12
Commercial Duty
Filter System.

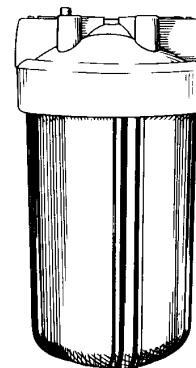

Wholehouse Filter
1" Connection



Dirt/Rust Water
Filter Cartridge



PRODUCTS FOR QUALITY WATER



DROP BY DROP, IT ALL ADDS UP

Since 1947, the family-owned and family operated Duff Company and its water conditioning division, DWC, have provided homeowners and business with more than just the cleanest, safest water possible; DWC has provided piece of mind.

Supplying quality products, service and technical support has earned DWC the trust of many corporations, industries and homeowners who use DWC water treatment systems. Offering a broad menu of services and systems in response to a variety of water needs, DWC delivers high-quality water with the product that fits your applications. DWC Products are distributed by professional dealers and contractors.

Enjoy cleaner, safer, fresher water right now, for less than you ever thought possible. Let DWC show you how, drop by drop, it all adds up.

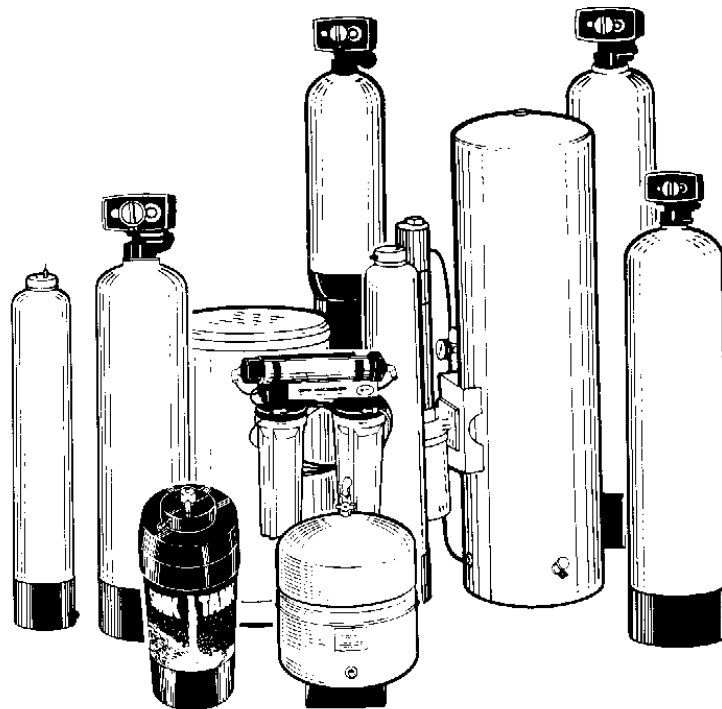

SIZING WATER SOFTENERS/FILTERS

NOTE: To be used as a guide only, as conditions vary greatly.

COMPENSATED HARDNESS

When sizing water conditioning equipment, the hardness should be based on compensated hardness. Compensated hardness takes into consideration minerals and other factors that will reduce the softening capacity of a softener. These items cannot be picked up in a standard hardness test. To arrive at compensated hardness, multiply the figure on the right by the hardness in grains per gallon by your test that fit into the hardness category on the left.

| YOUR TEST HARDNESS | MULTIPLY BY |
|--------------------|-------------|
| 1-20 | 1.1 |
| 21-40 | 1.2 |
| 41-70 | 1.3 |
| 71-100 | 1.4 |
| 100-Plus | 1.5 |

Always determine BOTH (1) Flow Rate and (2) Capacity in Total Grains.

SPACE AVAILABLE FOR EQUIPMENT

Length _____ Width _____ Height _____ Entrance door size _____
 Stairs _____ Hall _____ Any obstructions in path of entry of equipment _____
 Floor strength to hold weight of equipment _____. Floor drain size (ability to handle backwash water) _____. Water available for backwash or equipment installed _____.

SCHOOLS

(Estimated @ 25 gallons per day per student)

| NUMBER OF STUDENTS | 100 | 200 | 300 | 400 | 500 | 800 | 1,000 |
|-----------------------------------|-------|-------|-------|--------|--------|--------|--------|
| Total water usage | 2,500 | 5,000 | 7,500 | 10,000 | 12,500 | 20,000 | 25,000 |
| Peak flow with flush valves | 60 | 90 | 120 | 150 | 180 | 250 | 300 |
| Peak flow with flush tanks | 30 | 50 | 80 | 90 | 100 | 130 | 160 |
| Hot water only gallons per day | 600 | 1,200 | 1,800 | 2,400 | 3,000 | 4,800 | 6,000 |
| Hot water only gallons per minute | 15 | 23 | 30 | 40 | 50 | 60 | 70 |

APARTMENTS/TRAILER PARKS

(Central laundry included. Based on 3 people @ 60 gallons per day)

| NUMBER OF UNITS | 4 | 5 | 6 | 8 | 10 | 15 | 20 | 30 | 40 | 50 | 100 |
|--|-----|-----|-------|-------|-------|-------|-------|-------|-------|-------|--------|
| Total water usage gallons per day | 720 | 900 | 1,000 | 1,440 | 1,800 | 2,700 | 3,600 | 5,400 | 7,200 | 9,000 | 18,000 |
| Gallons per minute peak flow with flush tanks (no lawn sprinkling) | 22 | 25 | 30 | 40 | 50 | 75 | 90 | 110 | 125 | 140 | 220 |
| Hot water only gallons per day | 240 | 300 | 360 | 480 | 600 | 900 | 1,200 | 1,800 | 2,400 | 3,000 | 6,000 |
| Hot water peak flow gallons per minute | 12 | 15 | 20 | 26 | 30 | 45 | 55 | 65 | 75 | 85 | 110 |

MOTELS (Not Hotels)

Figures are based on 40 gallons per person per day. 2 1/2 people per unit, each unit containing a bathroom group. Estimate water usage for restaurant or cocktail bar facilities separately.

| NUMBER OF UNITS | 10 | 20 | 30 | 40 | 50 | 75 | 100 | 125 | 150 |
|---|-------|-------|-------|-------|-------|-------|--------|--------|--------|
| Total water usage gallons per day | 1,000 | 2,000 | 3,000 | 4,000 | 5,000 | 7,500 | 10,000 | 12,500 | 15,000 |
| Peak gallons per minute with flush valve | 65 | 90 | 109 | 128 | 145 | 180 | 210 | 240 | 270 |
| Peak gallons per minute with flush tanks | 26 | 43 | 55 | 65 | 75 | 105 | 130 | 152 | 172 |
| Hot water only gallons per day (estimate 16 gallons per person) | 400 | 800 | 1,200 | 1,600 | 2,000 | 3,000 | 4,000 | 5,400 | 6,000 |
| Hot water only flow gallons per minute | 17 | 25 | 36 | 43 | 48 | 62 | 73 | 85 | 96 |

WATER REQUIREMENTS OF OTHER ESTABLISHMENTS

****TO BE USED AS GUIDELINES ONLY**

| | |
|---------------------------|---|
| ANIMALS - GPD | EACH HORSE - 10 (add 5 in stables): EACH MILKING COW - 15 (add 15 with drinking cup): EACH DRY COW - 10 (with drinking cup add 10: EACH HOG - 3: EACH SHEEP - 2: EACH 100 CHICKENS in lighted henhouse - 5. |
| BEAUTY/BARBER SHOPS | 200 gallons per day per operator. |
| BOILERS | To determine daily make-up in gallons: 1) multiply boiler horsepower by 4.25. 2) then multiply (1) by hours per day of operation; 3) then multiply by the percentage operating rating; 4) then subtract the percentage of condensate return. |
| CLUBS | Showers X 600 GPD. Lavatories X 150 GPD. Meals X 4 gallons. |
| COOLING TOWERS | To determine daily make up in gallons; 1) Multiply the tonnage by 4 (this includes 2 gallons per ton hour evaporation and 2 gallons per ton hour bleed off). 2) Then multiply (1) by the hours per day of operation. |
| DORMITORIES | Estimate 40 gallons per person per day total water usage. Estimate 16 gallons per person per day hot water only. |
| GOLF CLUB/ GYM/FACTORY | Showers X 1300 GPD. Lavatories X 150 GPD. Meals X 4 gallons. Factory-16 GPD per employee not including process. |
| HOTELS | 350 GPD per guest room (hot and cold). Hot only 225 GPD per guest room |
| HOSPITALS | 250 GPD per bed for total water usage. 170 GPD per bed for hot water only. |
| LAUNDRY (WASHATERIA) | Flow rate - divide capacity of machine by 2 gallons per cycle - multiply pounds of laundry by 2 1./2l Total daily usage - gallons per cycle X 2 loads per hour X hours of operation X number of machines |
| NURSING HOMES | 75 GPD per bed for total water usage. 50 GPD per bed for hot water only. |
| OFFICE BUILDING | 15 GPD per person for total water usage. 2 GPD per person for hot water only. NOTE: NON-MEDI-CAL. |
| OIL REFINERY | 80,000 gallons per day per 100 barrels of crude processed. |
| PACKING HOUSE | 6 GPD per hot to 12 GPD per steer slaughtered. |
| POULTRY PACKING | 1 gallon per day per bird. |
| RESIDENCE | 60 GPD inside usage per person. 100 GPD per person inside & outside. |
| RESTAURANTS | Estimate 10 GPD per person (total water usage) or estimate 4 GPD per person (hot only). Add 30% water usage for 24 hour restaurants, add 2 GPD per person for cocktail/bar facilities. |
| RO SOFTENING | GPD product + GPD reject X grains compensated hardness (see previous page) X 1.5 (to use mini-mum salt capacity) X 2 days per regeneration or twins). |
| SCHOOLS | With cafeteria and showers estimate 25 GPD per student (total water usage) or estimate 10 GPD per student (hot water only). With cafeteria, no showers, estimate 15 GPD per student (total water usage) or estimate 4 GPD per student (hot water only). |
| STOCKYARDS | 160-200 gallons per acre total per day. |
| SUGAR REFINERY | 1 gallon per pound of sugar. |

| FLOW RATES IN PIPES - NOMINAL TO PEAK | | QUICK CHECK - FLOW RATE |
|---------------------------------------|--------------------|--|
| 1" = 16-30 gpm | 3" = 120-270 gpm | Nominal flow rate of a pipe = D2 x 20 Diameter squared x 20 |
| 1-1/4" = 30-35 gpm | 4" = 250-500 gpm | |
| 1-1/2" = 40-70 gpm | 6" = 500-1100 gpm | |
| 2" = 65-120 gpm | 8" = 1000-2000 gpm | |
| 2-1/2" = 80-170 gpm | 10" = 500-3000 gpm | |
| | | Twice the diameter x 4 times the flow |

For additional information call: 610-275-4453 or Fax: 610-279-6299
Please call for current prices.

FLOW RATES USING FIXTURE COUNTS

Before recommending a softener it is important to determine soft water service flow requirements and volume in a given time period. Water meters are the best source for such data. Where meters are not used, flow rates and total requirements may be estimated using the basic information. After determining this information, a properly sized softening unit may be recommended.

Use FIXTURE UNIT TABLE and INTERMITTENT FLOW RATE TABLE for average and maximum flow rates in private and public buildings in gallons per minute. The unit flow rates are to be used when actual continuous and peak flow rates are not known.

The average rates may be used when line pressure less the conditioner pressure drop is at least 30 psi at the highest point of use in the building. [approximately 4 psi loss per story.]

The maximum rates are equal to the fixture count figures commonly used to size drains and are applicable especially in low water pressure areas where pressure drop is critical.

D E T E R M I N E F L O W R A T E

| TYPE OF FIXTURE | UNIT FACTOR | |
|-------------------------------------|-------------|--------|
| | PRIVATE | PUBLIC |
| Bar sink | 1 | 2 |
| Bathtub/shower | 2 | 4 |
| Bedpan Washer | - | 10 |
| Bidet | 2 | 4 |
| Combination sink and tray | 3 | - |
| Dental unit or cuspidor | - | 1 |
| Dental lavatory | 1 | 2 |
| Drinking fountain | 1 | 2 |
| House bibb or sill cock (std. type) | 3 | 5 |
| House trailer (each) | 6 | 6 |
| Laundry tub or washer | 2 | 4 |
| Lavatory | 1 | 2 |
| Lawn sprinkler (each head) | 1 | 1 |
| Kitchen sink | 2 | 4 |
| Sink, service (janitor's) | 2 | 4 |
| Sink or domestic type dishwasher | 2 | 4 |
| Sink (flushing rim, clinic) | - | 10 |
| Sink (washup, each set of fixtures) | - | 2 |
| Sink (circular spray) | - | 4 |
| Urinal (wall or stand) | - | 5 |
| Urinal (flush tank) | - | 3 |
| Water closet (toilet): | | |
| Flush valve | 6 | 10* |
| Tank Type | 3 | 5* |

| FIXTURE COUNT FACTOR | AVERAGE GPM | MAXIMUM GPM |
|----------------------|-------------|-------------|
| 5 | 4 | 5 |
| 10 | 6 | 8 |
| 15 | 8 | 12 |
| 20 | 10 | 15 |
| 25 | 12 | 18 |
| 30 | 14 | 21 |
| 40 | 17 | 25 |
| 50 | 20 | 29 |
| 75 | 24 | 37 |
| 100 | 31 | 44 |
| 150 | 40 | 56 |
| 200 | 50 | 65 |
| 250 | 58 | 75 |
| 300 | 65 | 84 |
| 350 | 72 | 93 |
| 400 | 79 | 110 |
| 450 | 85 | 120 |
| 500 | 91 | 130 |
| 600 | 103 | 150 |
| 700 | 114 | 165 |
| 900 | 124 | 180 |
| 900 | 134 | 200 |
| 1000 | 143 | 210 |
| 1200 | 162 | 240 |
| 1400 | 181 | 260 |
| 1600 | 198 | 285 |
| 1800 | 216 | 310 |
| 2000 | 240 | 330 |
| 2200 | 260 | 354.5 |
| 2400 | 290 | 375 |
| 2600 | 300 | 395 |
| 2800 | 340 | 420 |
| 3000 | 380 | 440 |

NOTES:

- 1) For equipment not listed and likely to impose continuous demands (air conditioners, boilers, commercial dishwashers, etc.), estimate continuous supply and add to total flow rate for fixtures.
- 2) For fixtures not listed, unit factors may be estimated by comparing the fixture to listed one using water at a similar rate.
- 3) The given unit factors are for total demand for fixtures with both hot and cold water supplies. The unit factors for maximum hot water demand may be taken as 60% of the total unit factors.

DIRECTIONS:

- 1) Multiply the quantity of each type of fixture by its unit factor given in the UNIT TABLE.

PRIVATE-Apartments, trailers, homes, dorms, etc.

PUBLIC - Hospitals, motels nursing homes, schools, etc.

- 2) Add the values found in step 1 to determine the total fixture units.
- 3) Determine flow rates required from INTERMITTENT FLOW RATE TABLE Example-School (public)

| TYPE OF FIXTURE | QTY | UNIT FACTOR | TOTAL |
|-----------------------|-----|-------------|-------|
| Water closet (toilet) | | | |
| flush vlv | 15 | 10 | 300 |
| Lavatory | 15 | 2 | 30 |
| Shower | 5 | 4 | 20 |

TOTAL UNITS = 350

Flow rate (from table) average - 72 gpm; max - 93 gpm

SOFTENERS - AUTOTROL CONTROLS (255 OR 168)

| MODEL # | SOFTENER | TIME CLOCK MODEL | | METERED MODEL | |
|---------|--------------|------------------|-------|---------------|-------|
| | | FIG. NO. | PRICE | FIG. NO. | PRICE |
| DWC16 | 16,000 grain | 40913 | | 39948 | |
| DWC24 | 24,000 grain | 40740 | | 39949 | |
| DWC32 | 32,000 grain | 40741 | | 40864 | |
| DWC48 | 48,000 grain | 40742 | | 39950 | |
| DWC64 | 64,000 grain | 40743 | | 39951 | |
| DWC96 | 96,000 grain | 34086 | | - | |
| DWCC16* | 16,000 grain | 39947 | | 69721 | |
| DWCC24* | 24,000 grain | 40737 | | 53080 | |
| DWCC32* | 32,000 grain | 40738 | | 50459 | |



Standard Softener

FLECK CONTROLS (5600)

| MODEL # | SOFTENER | TIME CLOCK MODEL | | METERED MODEL | |
|----------|--------------|------------------|-------|---------------|-------|
| | | FIG. NO. | PRICE | FIG. NO. | PRICE |
| DWC16F | 16,000 grain | 42856 | | 42857 | |
| DWC24F | 24,000 grain | 42859 | | 42861 | |
| DWC32F | 32,000 grain | 42862 | | 42864 | |
| DWC48F | 48,000 grain | 42865 | | 42867 | |
| DWC64F | 64,000 grain | 42868 | | 42869 | |
| DWC96F | 96,000 grain | 42872 | | | |
| DWCC16F* | 16,000 grain | 42874 | | | |
| DWCC24F* | 24,000 grain | 42875 | | | |
| DWCC32F* | 32,000 grain | 42876 | | | |

SOFTENER SPECIFICATIONS

RESIDENTIAL DWC SOFTENER -AUTOTROL (255 OR 168) OR FLECK (5600) CONTROLS

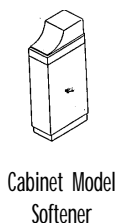

Cabinet Model Softener

| MODEL # | DWC | DWC | DWC | DWC | DWC | DWC |
|-----------------------------|-------|-------|-----------|-----------|-----------|-----------|
| | 16 | 24 | 32 | 48 | 64 | 96 |
| Max. Cap. (grains per day) | 16 | 24 | 32 | 48 | 64 | 96 |
| Min. Cap (grains per day) | 10 | 16 | 22 | 32 | 43 | 64 |
| Salt (Max) | 8 | 12 | 16 | 24 | 32 | 48 |
| Salt (Min) | 3 | 5 | 6.5 | 10 | 13 | 19 |
| Mineral Tank Size | 7x44 | 7x44 | 8x44 | 10x54 | 12x52 | 14x65 |
| Brine tank Size | 18x33 | 18x33 | 8x33 | 18x33 | 18x40 | 24x41 |
| Salt Storage (lbs.) | 300 | 300 | 300 | 300 | 400 | 500 |
| Service Flow Rate C/P (GPM) | 7/9 | 10/13 | 9/11 | 10/13 | 10/13 | 10/13 |
| Backwash Flow Rate (GPM) | 2 | 2.5 | 2.5 | 3 | 5 | 5 |
| IPS Pipe Size | 3/4" | 3/4" | 3/4 or 1" | 3/4 or 1" | 3/4 or 1" | 3/4 or 1" |
| Max. Height | 54" | 54" | 54" | 64" | 62" | 75" |
| Floor Space Required | 28x33 | 28x33 | 29x33 | 31x33 | 33x40 | 41x41 |
| Approx. Ship Weight | 75 | 100 | 110 | 130 | 190 | 220 |

C=Continuous Peak P=Peak

* Cabinet Models
 For additional information call: 610-275-4453 or Fax: 610-279-6299
 Please call for current prices.



**PRODUCTS FOR
QUALITY WATER**

**AUTOMATIC BACKWASHING
FILTERS**

DWC FILTERS ELIMINATE SPECIFIC PROBLEMS IN YOUR WATER SUPPLY.

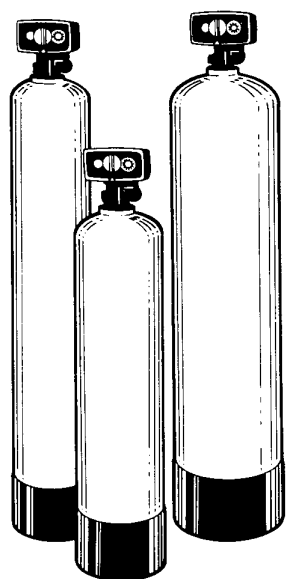

DWC filters are used to treat a wide variety of water problems, though no single filter can cure all of them. The filter media is selected to address the specific problems found in your water. Various media can eliminate staining, objectionable tastes and odors. Some water borne contaminants are invisible, odorless, and tasteless but can be removed by an activated carbon filter.

DWC automatic filters are like having a silent sentry on duty 24 hours a day. These units stop sediment, rust, acid, odors and unpleasant tastes, and backwash automatically to get rid of undesirable contaminants. In most cases, the homeowner does not have to change filter cartridges or remember to initiate any activity.

| SYMPTOM | POSSIBLE CAUSE | FILTER MEDIA |
|------------------|-----------------------|----------------------------------|
| Rust Stains | Iron | KDF-85, Greensand, Birm, Pyrolox |
| Black Stains | Manganese | Manganese Greensand |
| Green Stains | Acidic Water | Neutralizing crushed marble |
| Taste & Odor | Chlorine | Activated Carbon (coarse) |
| Rotten Egg Odor | Hydrogen Sulfide | KIDF-85 or Greensand |
| None | VOCs | Activated Carbon (Fine) |
| None | Benzene | Activated Carbon (Fine) |
| None | Aldicarb | Activated Carbon (Coarse) |
| Clogged Aerators | Sediment | Multi Media Bed |
| Taste & Odor | Organics | Activated Carbon |
| Taste | Lead | Activated Carbon |
| Taste | Mercury | Activated Carbon |
| Taste | Acrylamide | Activated Carbon |
| Color | Turbidity | Carbon & Multi Media Bed |
| Smell | Carbon Tetra Chloride | Activated Carbon |
| None | Trihalomethanes | Activated Carbon |
| None | Dichloromethane | Activated Carbon |

DWC BACKWASHING FILTERS



ACID NEUTRALIZERS AUTOTROL 163 HEADS



(NEUTRALIZERS HAVE DOME HOLES/MEDIA NOT INCLUDED)

| DESCRIPTION | DAN34 | DAN1 | DAN112 | DAN2 | DAN3 |
|-------------------------|----------|----------|----------|----------|----------|
| Mineral Tank Size | 10x35 | 10x40 | 10x54 | 12x52 | 13x54 |
| Service Flow Rate | 2.9 | 3.2 | 3.2 | 4.7 | 5.5 |
| Backwash Flow Rate | 5.4 | 5.4 | 5.4 | 7.8 | 9.2 |
| IPS Pipe Size | 3/4 or 1 | 3/4 or 1 | 3/4 or 1 | 3/4 or 1 | 3/4 or 1 |
| Maximum Height | 47 | 52 | 66 | 64 | 66 |
| Approximate Ship Weight | 133 | 157 | 207 | 251 | 400 |
| FIGURE NUMBER | 40896 | 40865 | 40867 | 40868 | 40869 |
| Price | | | | | |

ACID NEUTRALIZERS WITH FLECK 5600 FILTER VALVE

| DESCRIPTION | DAN34F | DAN1F | DAN112F | DAN2F | DAN3F |
|-------------------------|----------|----------|----------|----------|----------|
| Mineral Tank Size | 10x35 | 10x40 | 10x54 | 12x52 | 13x54 |
| Service Flow Rate | 2.9 | 3.2 | 3.2 | 4.7 | 5.5 |
| Backwash Flow Rate | 5.4 | 5.4 | 5.4 | 7.8 | 9.2 |
| IPS Pipe Size | 3/4 or 1 | 3/4 or 1 | 3/4 or 1 | 3/4 or 1 | 3/4 or 1 |
| Maximum Height | 47 | 52 | 66 | 64 | 66 |
| Approximate Ship Weight | 133 | 157 | 207 | 251 | 400 |
| FIGURE NUMBER | 42849 | 42844 | 42845 | 42847 | 42848 |
| Price | | | | | |

BIRM (IRON) UNITS WITH AUTOTROL 163 VALVE

| DESCRIPTION | DAB34 | DAB1 | DAB112 | DAB2 | DAB3 |
|-------------------------|----------|----------|----------|----------|----------|
| Mineral Tank Size | 10x35 | 10x40 | 10x54 | 12x52 | 13x54 |
| Service Flow Rate | 2.1 | 2.1 | 2.5 | 3.1 | 3.7 |
| Backwash Flow Rate | 6.5 | 6.5 | 6.5 | 7.8 | 9.3 |
| IPS Pipe Size | 3/4 or 1 | 3/4 or 1 | 3/4 or 1 | 3/4 or 1 | 3/4 or 1 |
| Maximum Height | 47 | 52 | 66 | 64 | 66 |
| Approximate Ship Weight | 95 | 107 | 132 | 151 | 250 |
| FIGURE NUMBER | 39975 | 39976 | 39978 | 39979 | 39980 |
| Price | | | | | |

BIRM (IRON) UNITS WITH FLECK 5600 VALVES

| DESCRIPTION | DAB34F | DAB1F | DAB112F | DAB2F | DAB3F |
|-------------------------|----------|----------|----------|----------|----------|
| Mineral Tank Size | 10x35 | 10x40 | 10x54 | 12x52 | 13x54 |
| Service Flow Rate | 2.1 | 2.1 | 2.5 | 3.1 | 3.7 |
| Backwash Flow Rate | 6.5 | 6.5 | 6.5 | 7.8 | 9.3 |
| IPS Pipe Size | 3/4 or 1 | 3/4 or 1 | 3/4 or 1 | 3/4 or 1 | 3/4 or 1 |
| Maximum Height | 47 | 52 | 66 | 64 | 66 |
| Approximate Ship Weight | 95 | 107 | 132 | 151 | 250 |
| FIGURE NUMBER | 42825 | 42820 | 42821 | 42823 | 42824 |
| Price | | | | | |

**DWC BACKWASHING FILTERS
GREENSAND UNITS WITH AUTROL 168FA**

| DESCRIPTION | DAG34 | DAG1 | DAG112 | DAG2 | DAG3 |
|-------------------------|----------|----------|----------|----------|----------|
| Mineral Tank Size | 10x35 | 10x40 | 10x54 | 12x52 | 13x54 |
| Service Flow Rate | 2.2 | 2.2 | 2.7 | 3.8 | 4.6 |
| Backwash Flow Rate | 5 | 5 | 5.5 | 7.9 | 9.3 |
| IPS Pipe Size | 3/4 or 1 | 3/4 or 1 | 3/4 or 1 | 3/4 or 1 | 3/4 or 1 |
| Maximum Height | 47 | 52 | 66 | 64 | 66 |
| Approximate Ship Weight | 128 | 152 | 202 | 246 | 395 |
| FIGURE NUMBER | 39987 | 40887 | 40888 | 40021 | 39991 |
| Price | | | | | |

GREENSAND UNITS WITH FLECK 5600 VALVES

| DESCRIPTION | DAG34F | DAG1F | DAG112F | DAG2F | DAGF3 |
|-------------------------|----------|----------|----------|----------|----------|
| Mineral Tank Size | 10x35 | 10x40 | 10x54 | 12x52 | 13x54 |
| Service Flow Rate | 2.2 | 2.2 | 2.7 | 3.8 | 4.6 |
| Backwash Flow Rate | 5 | 5 | 5.5 | 7.9 | 9.3 |
| IPS Pipe Size | 3/4 or 1 | 3/4 or 1 | 3/4 or 1 | 3/4 or 1 | 3/4 or 1 |
| Maximum Height | 47 | 52 | 66 | 64 | 66 |
| Approximate Ship Weight | 128 | 152 | 202 | 246 | 395 |
| FIGURE NUMBER | 43419 | 43420 | 43422 | 43423 | 43424 |
| Price | | | | | |

POTASSIUM PERMANGANATE FEEDER

Potassium Permanganate Feeder

For drawing chemicals into a Manganese Greensand bed for cleaning. Can also be used for Chlorine draw into a Pyrodox bed.

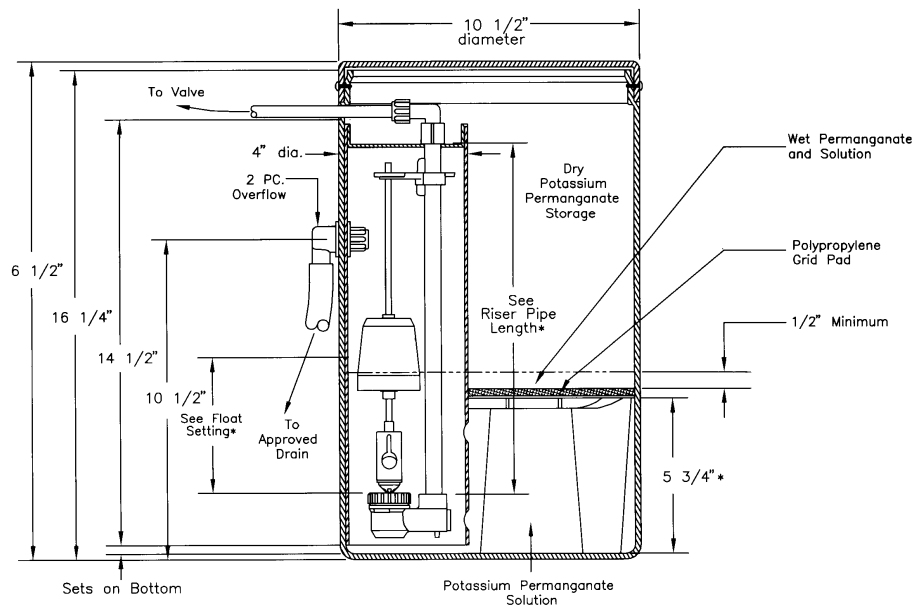

| FIG. NO. | OZ. OF POTASSIUM PERMANGANATE | POLYTUBE ELBOW SIZE | GALLONS OF SOLUTION | FLOAT SETTING | RISER PIPE LENGTH | PRICE |
|----------|-------------------------------|---------------------|---------------------|---------------|-------------------|-------|
| 40886 | 4 Oz. | 3/8" | 1 | 4" | 12 1/2" | |

**DWC BACKWASHING FILTERS
FILTER AG UNITS WITH AUTOTROL HEADS
(SEDIMENT UNIT)**

| DESCRIPTION | DAF34 | DAF1 | DAF112 | DAF2 | DAF3 |
|-------------------------|----------|----------|---------|----------|----------|
| Mineral Tank Size | 10x35 | 10x40 | 10x54 | 12x52 | 13x54 |
| Service Flow Rate | 21 | 2.1 | 2.5 | 3.1 | 3.7 |
| Backwash Flow Rate | 6.5 | 6.5 | 6.5 | 7.8 | 9.3 |
| IPS Pipe Size | 3/4 or 1 | 3/4 or 1 | 34 or 1 | 3/4 or 1 | 3/4 or 1 |
| Maximum Height | 47 | 52 | 66 | 64 | 66 |
| Approximate Ship Weight | 95 | 107 | 132 | 151 | 250 |
| FIGURE NUMBER | 39969 | 40882 | 39972 | 40883 | 40884 |
| Price | | | | | |

FILTER AG UNITS WITH FLECK 5600 VALVES

| DESCRIPTION | DAF34F | DAF1F | DAF112F | DAF2F | DAF3F |
|-------------------------|----------|----------|---------|----------|----------|
| Mineral Tank Size | 10x35 | 10x40 | 10x54 | 12x52 | 13x54 |
| Service Flow Rate | 2.1 | 2.1 | 2.5 | 3.1 | 3.7 |
| Backwash Flow Rate | 6.5 | 6.5 | 6.5 | 7.8 | 9.3 |
| IPS Pipe Size | 3/4 or 1 | 3/4 or 1 | 34 or 1 | 3/4 or 1 | 3/4 or 1 |
| Maximum Height | 47 | 52 | 66 | 64 | 66 |
| Approximate Ship Weight | 95 | 107 | 132 | 151 | 250 |
| FIGURE NUMBER | 42837 | 42832 | 42833 | 42835 | 42836 |
| Price | | | | | |

ACTIVATED CARBON UNITS AUTOTROL 163

| DESCRIPTION | DAC34 | DAC1 | DAC112 | DAC2 | DAC3 |
|-------------------------|----------|----------|---------|----------|----------|
| Mineral Tank Size | 10x35 | 10x40 | 10x54 | 12x52 | 13x54 |
| Service Flow Rate | 2.2 | 2.2 | 2.7 | 3.9 | 4.6 |
| Backwash Flow Rate | 5 | 5 | 5 | 7 | 9 |
| IPS Pipe Size | 3/4 or 1 | 3/4 or 1 | 34 or 1 | 3/4 or 1 | 3/4 or 1 |
| Maximum Height | 47 | 52 | 66 | 64 | 66 |
| Approximate Ship Weight | 79 | 90 | 105 | 117 | 194 |
| FIGURE NUMBER | 39953 | 40895 | 40874 | 25227 | 40875 |
| Price | | | | | |

ACTIVATED CARBON UNITS FLECK 5600 VALVES

| DESCRIPTION | DAC34F | DAC1F | DAC112F | DAC2F | DAC3F |
|-------------------------|----------|----------|---------|----------|----------|
| Mineral Tank Size | 10x35 | 10x40 | 10x54 | 12x52 | 13x54 |
| Service Flow Rate | 2.2 | 2.2 | 2.7 | 3.9 | 4.6 |
| Backwash Flow Rate | 5 | 5 | 5 | 7 | 9 |
| IPS Pipe Size | 3/4 or 1 | 3/4 or 1 | 34 or 1 | 3/4 or 1 | 3/4 or 1 |
| Maximum Height | 47 | 52 | 66 | 64 | 66 |
| Approximate Ship Weight | 79 | 90 | 105 | 117 | 194 |
| FIGURE NUMBER | 42831 | 42826 | 42827 | 42829 | 42830 |
| Price | | | | | |

DWC UPFLOW FILTERS

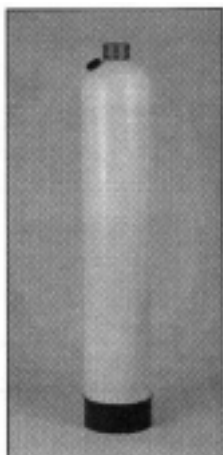

- *USE NO ELECTRICITY
- *SAVES WATER - NO BACKWASHING
- *NO DRAIN REQUIRED
- *SIMPLE TO INSTALL
- *ADJUSTS PH OF ACID WATER WITHOUT EXTRA PUMPS
- *EASY MEDIA REPLENISHMENT
- *MUST BE USED ON CLEAN WATER - DIRT WILL FOUL THE BED



Products for Quality Water

**DWC UPFLOW FILTERS
ACID NEUTRALIZERS**

| DESCRIPTION | DUN34 | DUN1 | DUN112 | DUN2 | DUN3 |
|-------------------------|----------|----------|----------|----------|----------|
| Mineral Tank Size | 10x35 | 10x40 | 10x54 | 12x52 | 13x54 |
| Service Flow Rate | 2.9 | 3.2 | 3.2 | 4.7 | 5.5 |
| IPS Pipe Size | 3/4 or 1 | 3/4 or 1 | 3/4 or 1 | 3/4 or 1 | 3/4 or 1 |
| Maximum Height | 47 | 52 | 66 | 64 | 66 |
| Approximate Ship Weight | 130 | 154 | 201 | 247 | 396 |
| FIGURE NUMBER | 39963 | 40880 | 40881 | 39967 | 39968 |
| Price | | | | | |

DUN Series Upflow Neutralizers virtually eliminate the possibility of media bed "cementing" because the water to be treated actually "upflows" through the neutralizer media bed! This procedure requires NO electricity or backwashing. All fill cap in the media tank top permits easy replenishment of the "sacrificial" neutralizing media.

UPFLOW CARBON UNITS

| DESCRIPTION | DUC34 | DUC1 | DUC112 | DUC2 | DUC3 |
|-------------------------|----------|----------|----------|----------|----------|
| Mineral Tank Size | 10x35 | 10x40 | 10x54 | 12x52 | 13x54 |
| Service Flow Rate | 2.2 | 2.2 | 2.7 | 3.9 | 4.6 |
| IPS Pipe Size | 3/4 or 1 | 3/4 or 1 | 3/4 or 1 | 3/4 or 1 | 3/4 or 1 |
| Maximum Height | 47 | 52 | 66 | 64 | 66 |
| Approximate Ship Weight | 76 | 87 | 102 | 114 | 190 |
| FIGURE NUMBER | 39957 | 39958 | 40879 | 39961 | 38066 |
| Price | | | | | |

FILTER APPLICATIONS

| | Backwash** Flow Rate gpm/ft. ² (ml/min/cm ²) | Service Flow Rate gpm/ft. ² (ml/min/cm ²) | Recommended Bed Depth inches (cm) | Bed Expansion/ Freeboard as % Bed Depth | Weight lbs./cu. ft. (grams/liter) | Regenerant Required per cu. ft. (m ³) | ph Range |
|--|---|---|---|---|---|--|------------------|
| Manganese Greensand for Iron Removal | 8 - 12 (33 - 49) | 5 (20) | 30 (76) | 35 - 50% | 85 (1,362) | 2 - 4 oz. KMnO ₄ (1.6 - 3.2 grams) | 7.0 or higher |
| Regular Birm* for Iron Removal | 10 - 12 (41 - 49) | 5 (20) | 30 - 36 (76 - 91) | 35 - 50% | 48 (769) | None | 7.0 or higher |
| Activated Carbon for Taste & Odor Removal | 8 - 10 (33 - 41) | 5 (20) | 30 (76) | 35-50% | 33 (529) | None | Wide Range |
| Filter - Ag. for Sediment (Turbidity) Removal | 8 - 10 (33 - 41) | 5 (20) | 24-36 (61 - 91) | 50% | 25 (401) | None | Wide Range |
| Filter Sand for Sediment (Turbidity) Removal | 12 - 15 (49 - 61) | 3 - 5 (12 - 20) | 24 - 30 (61 - 76) | 35 - 50% | 100 (1,602) | None | Wide Range |
| | Sand is also used for High Rate Sand Filters with Service Rates of 15-20 gpm/sq. ft. and backwash at the same rate. | | | | | | |
| Calcite for Ph correction | 8-12 (33-49) | 3-6 (12-25) | 24-30 (61-76) | 35% | 100 (1,602) | None | 5-6.5 |
| MTM for down manganese and Hydrogen Sulphur removal | 8-10 (33-41) | 3-5 (12-20) | 24-36 (61-91) | 50% | 27 (432) | 1.5-2 oz. (1.25-1.6 grams) | 6.5-9.0 |
| Corosex for Ph correction | 8-12 (33-49) | 5-6 (20-24) | 24-30 (61-76) | 35% | 100 (1,602) | None | 4-6Ph |

BRASS BY-PASS VALVES

HOUSE PORTS ON 1.875" CENTERS
EQUIPMENT PORTS ON 3" CENTERS

| FIG. NO. | DESCRIPTION | PRICE |
|----------|--------------------------|-------|
| 43535 | 3/4 CopxCop Bypass | |
| 57772 | 3/4 SlipxThrd Bypass | |
| 57773 | 1 SlipxThrd Bypass | |
| 51699 | 1 CopxCop Bypass | |
| 47622 | 3/4 ThrdxThrd Bypass | |
| 64348 | 3/4 CopxAutotrol Bypass | |
| 64349 | 1 CopxAutotrol Bypass | |
| 34090 | Thrd Manual Filter Valve | |
| 47784 | Thrd Bypass Vlv 7700112 | |
| 53555 | Thrd Bypass Stem 0790061 | |

FILTRATION MEDIA

ACTIVATED CARBON A coarse grade of carbon used in chlorine and taste & odor removal by adsorption. The 8 x 30 mesh size allows treatment with the least amount of flow loss, and filters particles 40 micron and higher.

ACTIVATED CARBON A fine grade of high quality carbon used for taste, odor, chlorine and organics removal, including VOCs. The 12 x 40 mesh size traps particles 30 micron and higher.

KDF-55 A bi-metal, copper-zinc, material used in chlorine, and heavy metal removal as well as the removal of corrosion and microorganisms. Chlorine is changed by the exchange of electrons and heavy metals bond to the media. Use in pH range of 6.5-8.5 and TDS greater than 150 ppm. KDF can control bacteria, algae, mold and fungi growth. When used with activated carbon, KDF 55 extends the life of the carbon media.

KDF-85 A bi-metal, copper-zinc, material used in iron and hydrogen sulfide removal. Iron is reduced and hydrogen sulfide is oxidized in this oxidation/reduction process. KDF can control bacteria, algae and fungi growth.

CENTAUR CARBON Centaur 12x40 is a liquid phase virgin activated carbon that has been manufactured from bituminous coal to promote catalytic reactions. Centaur can be used for the promotion of oxidation, reduction, decomposition, substitution and emanation reactions.

CALCITE Acidic waters on contact with calcite slowly dissolve the calcium carbonate media to raise the pH which reduces the potential leaching of copper, lead and other metals found in typical plumbing systems. Periodic backwashing will prevent packing and maintain high service rates. As the Calcite's calcium carbonate neutralizes the water, it will increase hardness and a softener may become necessary after the neutralizing filter.

COROSEX By neutralizing the free carbon dioxide in water, Corosex can correct red water conditions and render it to a non-corrosive condition. Corosex, being a reactive magnesium oxide, is used most effectively where pH correction is substantial or high flow conditions are in use. Corosex, being soluble to acidity, will have to be replenished periodically. Corosex can be effectively combined with Calcite to combine the high flow neutralization properties of Corosex, along with the slower reacting low flow properties of Calcite reducing potentially high basic properties due to overcorrection.

MANGANESE GREENSAND A gluttonite greensand that is a catalytic material, capable of removing iron, manganese, and hydrogen sulfide. This media must be regenerated intermittently with potassium permanganate or continuously with chlorine or a chlorine potassium permanganate mixture.

BIRM Birm is a light weight catalyst filter material used in iron and manganese removal. When sufficient dissolved oxygen is present, naturally or by air induction, an oxidizing reaction will take place. The oxidized iron or manganese is then filterable by the filter material. Birm is a plastic bead coated with naturally occurring manganese oxide.

PYROLOX Works on the principal of catalyst reaction for the removal of iron, hydrogen sulfide and manganese. Sufficient oxygen must exist in the water, naturally or by air induction. This media does not require regeneration but is a heavy material that requires vigorous backwashing on a daily basis.

MULTI-MEDIA Multi-media is reverse graded layers of filter media including anthracite, sand, garnet, and gravel. The largest and lightest material is on the top, trapping the largest particles. In descending order the next heaviest and smaller media traps the next largest particles, and so on until the smaller particle is trapped in the bottom layer. This process allows for higher flow rates and filtration down to 10 micron sized particles. Good for sediment, turbidity, and red water iron.

FILTER-Ag Filter-Ag granuals have irregular surface characteristics affording maximum removal of suspended matter through-out the filter bed. Filter-Ag can be applied to systems designed for either pressure or gravity flow. Filter-Ag has many outstanding advantages over the more common granular filter medias used for suspended solids removal. A substantial saving can be realized, when designing a system using Filter-Ag, because equipment can be smaller, requiring less square foot area. Filter-Ag is lightweight a substance with means additional saving in backwash rates. Filter-Ag typically removes the normal suspended solids, down to the the 20-40 micron range.

GRAVEL Gravel is used as a support to keep smaller medias out of the distribution system and to stop channeling of water. Minimum layers of 3" per size is suggested. A high proportion are rounded and tend toward a spherical shape.

SAND 99% of the water purified in the world today is accomplished by passing the water through "rapid sand filters". Theoretically the upper layer of the bed performs the filtration, while the lower layers provide the necessary support and assist in the hydraulics involved during the backwash cycle. The chemical and physical properties are important. The media must be hard, not smooth, and free of soluble particles.

GARNET Garnet is a naturally hard, durable, high specific gravity mineral. Resistance to attrition means less loss of media and shutdown time. High specific gravity means more control during backwash and lower losses to drain. The angular shape provides more ability to filter and longer production runs.

ANTHRACITE The use of anthracite coal as a filter media predates the 1930's. This is a particular hard coal product which is produced from selected Pennsylvania coals. These coals are not readily found and have low ash and friability while being high in anthraxylor. After selection, the coal is cleaned (reduction in ash content), screened and classified to the proper sized for water filtration purposes. The advantages in use versus silica and quartz sands and gravels are: longer runs between backwashes, higher flow rates without headloss, lower backwash water pressures and/or quantities, a greater utilization of the bed mass for filtration, and a volumetric higher surface area.

| FILTRATION MEDIA SELECTION CHART | | | | | | | |
|----------------------------------|---------------------------------|-----------|-------|----------|-------------------------------|-----------|-------|
| FIG. NO. | DESCRIPTION | SIZE | PRICE | FIG. NO. | DESCRIPTION | SIZE | PRICE |
| 51447 | Activated Carbon (course grade) | 1 cu. ft. | | 66341 | Multi Media Pack for 18" tank | 18" tank | |
| 65382 | Acid Wash Carbon | 2 cu. ft. | | 51467 | Multi Media Pack for 21" tank | 21" tank | |
| 50533 | CPG Acid Washed Carbon | 2 cu. ft. | | 48981 | Multi Media Pack for 24" tank | 24" tank | |
| 47828 | Filtersorb 300 8-30 mesh | 2 cu. ft. | | 53052 | Multi Media Pack for 30" tank | 30" tank | |
| 51593 | Filtersorb 400 12040 mesh | 2 cu. ft. | | 51973 | Multi Media Pack for 36" tank | 36" tank | |
| 59967 | Activated Carbon (fine grade) | 1 cu. ft. | | 52221 | Multi Media Pack for 48" tank | 48" tank | |
| 61672 | KDF 55 | 1 cu. ft. | | 51448 | Filter Ag | 1 cu. ft. | |
| 63853 | KDF 85 | 1 cu. ft. | | 58206 | Gravel 3/16 x #10 | 50 lb. | |
| 51396 | Centaur Carbon | 1 cu. ft. | | 58205 | Gravel 1/4 x 1/8 | 50 lb. | |
| 47946 | Calcite | 50 lb. | | 58208 | Gravel 1/2 x 1/4 | 50 lb. | |
| 67851 | Thomasville Lime | 50 lb. | | 58209 | Gravel 3/4 x 1/2 | 50 lb. | |
| 52544 | Limestone Chips | 50 lb. | | 51777 | Gravel 1-1/2 x 3/4 | 100 lb. | |
| 47949 | Georgia Marble XO White | 50 lb. | | 40885 | Sand #2 | 100 lb. | |
| 51465 | Georgia Marble 2 Grade | 100 lb. | | 45173 | Sand #3 | 100 lb. | |
| 47947 | Corosex I | 50 lb. | | 45174 | Sand #4 | 100 lb. | |
| 51196 | Corosex II | 100 lb. | | 58204 | Sand #5 | 50 lb. | |
| 51449 | Manganese Greensand | 1 cu. ft. | | 60649 | Garnet #8 | 100 lb. | |
| 39849 | Birm | 1 cu. ft. | | 51458 | Garnet #80-12 | 100 lb. | |
| 44616 | Fine Mesh Birm | 1 cu. ft. | | 51445 | Garnet #20 | 100 lb. | |
| 45189 | Pyrolox | 50 lb. | | 51459 | Garnet #30-40 | 100 lb. | |
| 50321 | Multi Media Pack for 10" tank | 10" tank | | 51947 | Anthracite #1 | 1 cu. ft. | |
| 50317 | Multi Media Pack for 13" tank | 13" tank | | 51460 | Anthracite #2 | 1 cu. ft. | |
| 51626 | Multi Media Pack for 14" tank | 14" tank | | | | | |
| 50631 | Multi Media Pack for 16" tank | 16" tank | | | | | |

COMMERCIAL WATER SOFTENERS

1. DAY CLOCK REGENERATION

- a. 7 and 12 day regeneration cycles available.
- b. Standard regeneration time 2:00 am - this can be altered with new 24 hour label.
- c. Twin systems with clock regeneration usually will have staggered regeneration times (Min. 3 hour difference).
- d. Twin clock systems come standard with hard water by-pass during regeneration. systems can be designed with no hard water by-pass.
- e. Single or twin systems must be designed for minimum 1 day capacity. (Note - special systems with multiple regenerations per day are available - consult Duff Co.)
- f. Clock type systems are best suited where water consumption is constant on a day-to-day or peak demand days are predictable on the same day(s) each week.
- g. Twin systems usually are used when high peak flows are needed.

2. WATER METER INITIATED

- a. 5 Basic Metered Systems:
 - 1) 1 tank-1 meter - immediate regeneration - hard water by-pass during regeneration has no bearing on system. No reserve capacity required.
 - 2) 1 tank-1 meter - delayed regeneration - hard water by-pass during regeneration must be at low usage time. 1 day capacity reserve required.
 - 3) System #5-2 tanks-2 meters - Both units in service at the same time; only 1 unit can regenerate at a time (lock out). Can be designed with immediate or delayed regeneration, hard water by-pass or no hard water by-pass. Delayed regeneration should have a 1 day reserve.
 - 4) System #6 - 2 tanks-1 meter - both units in service at the same time. Once meter zeroes out, #1 unit regenerates, then #2 regenerates. (Series regeneration). Can be designed with immediate or delayed regeneration should have a 1 day reserve.
 - 5) System #7-2 tanks - 1 meter - One unit in service, one unit fresh and ready on standby, (also referred to as Alternators). Systems are usually designed with no hard water by-pass and with immediate regeneration. 3 hour meter reset reserve capacity needed.

System #7 may be ordered as a tri-plex or quadplex. This will allow 2 or 3 units to be in service at all times, with 1 unit on standby. The systems are of particular value when access to the location of installation is limited. Also, these will afford much greater flow rates, without the expense and handling of very large tanks.

- b. Metered systems are best suited for erratic, unpredictable water usages. Twin systems both in service at the same times are usually used when high peak flows are needed. Alternator systems are used where soft water must be available at all times.

DWC TRAINING INFORMATION

AN INFORMATION LIST FOR COMMERCIAL SIZING

1. Always measure the installation area and pathway to the area.
2. What is water temperature? _____
3. Where is drain and is it sufficient to handle the drain flow?
4. Is there a uninterrupted source of electric? Confirm voltage.
5. What is the pipe size of the system? _____
6. What is the water going to be used for? _____
7. What is the desired quality of the product water? _____
8. Where is the water being supplied from? _____
9. What is the operating pressure of the system? _____
10. What hours will the system be needed? _____
11. What will be the estimated water usage in the timed listed above?

12. Do they look to expand this system in the future? _____
13. What will be the required continuous flow rate required? _____
14. What will be the required peak flow rate? _____
15. From the water analysis determine the compensated hardness.
_____ GPG
16. From the water analysis what is the Total Dissolved Solids?
TDS_____PPM

First determine how much resin will be needed. If possible a system should last 24 to 72 hours between regeneration. From above take the estimated water usage from line 10 _____ x the compensated hardness on line 13 _____ = total grains required per day _____. Then multiply by days between regeneration x _____ = total grains required each regeneration _____.

Example: usage _____ x hardness _____ = total grains per day _____
x days between _____ = grains per regeneration.

Next determine desired salting level keeping in mind there will be some hardness leakage at lower salting levels. (Always consult resin specifications and be sure the water quality will meet the customer's requirements inline 6.)

Select a salting level @ _____ pounds per cubic ft. Next locate on the capacity charge the total grains per regeneration required from above in the desired salting level column to find the resin volume needed in cu.ft. _____.

Example: at _____ lb. per cu ft it will require _____ cubic feet of resin to meet the demand. Now we can select our system.

What type of system will be needed to supply the needs of your customer.?

DWC COMMERCIAL SOFTENERS

FEATURING THE AUTOTROL MAGNUM VALVE

| DESCRIPTION | DWC150 942 | DWC180 942 | DWC210 942 | DWC240 942 | DWC300 942 | DWC360 942 | DWC450 942 | DWC600 942 |
|--------------------|---------------|---------------|---------------|---------------|---------------|---------------|---------------|---------------|
| Pipe Size | 1 1/2 | 1 1/2 | 1 1/2 | 1 1/2 | 1 1/2 | 1 1/2 | 1 1/2 | 1 1/2 |
| Tank Size | 18x65 | 20x62 | 20x62 | 24x60 | 24x72 | 30x72 | 30x72 | 36x72 |
| Resin Cu. Ft. | 5 | 6 | 7 | 8 | 10 | 12 | 15 | 20 |
| Gravel | 50 | 75 | 75 | 100 | 100 | 150 | 200 | 300 |
| Brine Tank Size | 24x41 | 24x41 | 24x41 | 24x41 | 24x50 | 24x50 | 30x48 | 39x48 |
| Salt Fill | 500 | 500 | 500 | 500 | 600 | 600 | 900 | 900 |
| Max Capacity | 150,000 | 180,000 | 510,000 | 240,000 | 300,000 | 360,000 | 450,000 | 600,000 |
| Min Capacity | 100,000 | 120,000 | 140,000 | 160,000 | 200,000 | 240,000 | 300,000 | 400,000 |
| Lbs. Per Reg - Max | 75 | 90 | 105 | 120 | 150 | 170 | 225 | 300 |
| Lbs. Per Reg - Min | 30 | 36 | 42 | 48 | 60 | 75 | 90 | 120 |
| Flowrate Service | 43 | 52 | 52 | 62 | 62 | 65 | 70 | 82 |
| Flowrate Backwash | 11 | 13 | 13 | 15 | 15 | 18 | 25 | 35 |
| Fig. No. | 75754 | 75756 | 75758 | 75760 | 75762 | 75765 | 75767 | 75769 |
| Price | | | | | | | | |

THE MAGNUM CV

Mechanical or electronic timer options make Magnum one of the most versatile commercial and industrial valves available today. Standard 12-volt operation makes installation easy.

Camshaft driven pilot flapper valves control the diaphragm cartridges.

A pilot filter screen keeps the pilot ports and lines clean and free of debris

An optional pressure regulator maintains regeneration pressure for countercurrent or co-current systems subject to major pressure fluctuations.

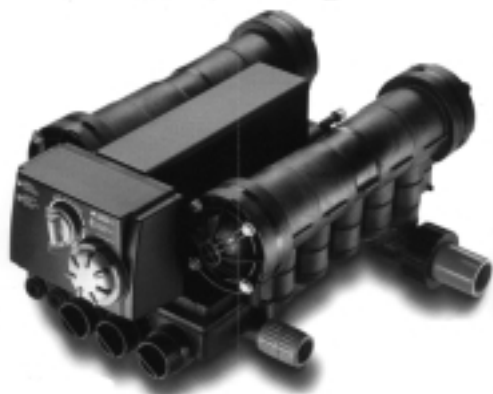

Matched set flow controls for 16 to 36 inch tanks makes for easy selection of flow components.

Hard water bypass is available factory installed or as an easy field upgrade.

A variety of pipe adapters make it easy to connect to the system.

The high flow injection molded Noryl body is tough but light, for easy handling and installation. The valve is available in a co-current or countercurrent configuration.

Cartridge style brine refill flow control and eductor assemblies make servicing, changing out or cleaning a breeze.

Superior flow rate and pressure drop performance are provided.

FLECK WATER SOFTENERS

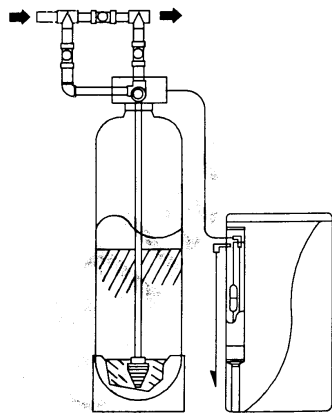

COMMERCIAL FLECK 2700 WATER SOFTENER
FIBERGLASS

TDS, application and flow rates will influence the performance of the system.

| FIG. NO. | MODEL # | PIPE SIZE | MINERAL TANK | | BRINE TANK | | SOFTENING CAPACITY | | LBS SALT PER GENER | | FLOW RATE GPM | | | WGHT | PRICE |
|----------|------------|-----------|--------------|--------------|----------------|-------|--------------------|---------|--------------------|-----|---------------|-------|-----|------|-------|
| | | | TANK SIZE | RESIN CU.FT. | Gravel 1/4x1/8 | SIZE | SALT FILL | MAX | MIN | MAX | MIN | SRVC | BRW | | |
| 47892 | DWC 902700 | 1" | 14X65 | 3 | 60 | 24X41 | 500 | 90,000 | 60,000 | 45 | 18 | 18/23 | 5 | 240 | |
| 43582 | DWC1202700 | 1" | 16X65 | 4 | 80 | 24X41 | 500 | 120,000 | 80,000 | 60 | 24 | 18/23 | 7 | 320 | |

COMMERCIAL FLECK 2750 WATER SOFTENERS
FIBERGLASS

| FIG. NO. | MODEL # | PIPE SIZE | MINERAL TANK | | BRINE TANK | | SOFTENING CAPACITY | | LBS SALT PER GENER | | FLOW RATE GPM | | | WGHT | PRICE |
|----------|------------|-----------|--------------|--------------|----------------|-------|--------------------|---------|--------------------|-----|---------------|-------|-----|------|-------|
| | | | TANK SIZE | RESIN CU.FT. | Gravel 1/4x1/8 | SIZE | SALT FILL | MAX | MIN | MAX | MIN | SRVC | BRW | | |
| 47894 | DWC 902750 | 1" | 14X65 | 3 | 60 | 24X41 | 500 | 90,000 | 60,000 | 46 | 20 | 20/24 | 6 | 240 | |
| 43583 | DWC1202750 | 1" | 16X65 | 4 | 80 | 24X41 | 500 | 120,000 | 80,000 | 65 | 25 | 20/24 | 8 | 320 | |

COMMERCIAL FLECK 2750 METERED SOFTENERS
FIBERGLASS

| FIG. NO. | MODEL # | PIPE SIZE | MINERAL TANK | | BRINE TANK | | SOFTENING CAPACITY | | LBS SALT PER GENER | | FLOW RATE GPM | | | WGHT | PRICE |
|----------|-------------|-----------|--------------|--------------|----------------|-------|--------------------|---------|--------------------|-----|---------------|-------|-----|------|-------|
| | | | TANK SIZE | RESIN CU.FT. | Gravel 1/4x1/8 | SIZE | SALT FILL | MAX | MIN | MAX | MIN | SRVC | BRW | | |
| 47895 | DWC902750M | 1" | 14X65 | 3 | 60 | 24X41 | 500 | 90,000 | 60,000 | 46 | 20 | 20/24 | 6 | 245 | |
| 43585 | DWC1202750M | 1" | 16X65 | 4 | 80 | 24X41 | 500 | 120,000 | 80,000 | 65 | 25 | 20/24 | 8 | 325 | |

COMMERCIAL FLECK 2850 WATER SOFTENERS
FIBERGLASS

| FIG. NO. | MODEL # | PIPE SIZE | MINERAL TANK | | BRINE TANK | | SOFTENING CAPACITY | | LBS SALT PER GENER | | FLOW RATE GPM | | | WGHT | PRICE |
|----------|------------|-----------|--------------|--------------|----------------|-------|--------------------|---------|--------------------|-----|---------------|------|-----|------|-------|
| | | | TANK SIZE | RESIN CU.FT. | Gravel 1/4x1/8 | SIZE | SALT FILL | MAX | MIN | MAX | MIN | SRVC | BRW | | |
| 43397 | DWC902850 | 1 1/2" | 14X65 | 3 | 50 | 24X41 | 500 | 90,000 | 60,000 | 45 | 18 | 21 | 5 | 240 | |
| 43398 | DWC1202850 | 1 1/2" | 16X65 | 4 | 50 | 24X41 | 500 | 120,000 | 80,000 | 60 | 24 | 28 | 7 | 320 | |
| 62523 | DWC1502850 | 1 1/2" | 18X65 | 5 | 50 | 24X41 | 500 | 150,000 | 100,000 | 75 | 30 | 43 | 11 | 380 | |
| 43399 | DWC1802850 | 1 1/2" | 20X62 | 6 | 75 | 24X41 | 500 | 180,000 | 120,000 | 90 | 48 | 44 | 13 | 479 | |
| 43400 | DWC2102850 | 1 1/2" | 20X62 | 7 | 75 | 24X41 | 500 | 210,000 | 140,000 | 105 | 56 | 44 | 13 | 585 | |
| 43401 | DWC2402850 | 1 1/2" | 24X60 | 8 | 100 | 24X41 | 500 | 240,000 | 160,000 | 120 | 64 | 44 | 15 | 648 | |
| 43402 | DWC3002850 | 1 1/2" | 24X72 | 10 | 100 | 24X50 | 600 | 300,000 | 200,000 | 150 | 80 | 44 | 15 | 710 | |
| 43403 | DWC3602850 | 1 1/2" | 30X72 | 12 | 100 | 24X50 | 600 | 360,000 | 200,000 | 180 | 96 | 44 | 15 | 815 | |

COMMERCIAL FLECK 2850 METERED

WATER SOFTENERS

| FIG. NO. | MODEL # | PIPE SIZE | TANK SIZE | RESIN CU FT | GRAVEL 1/4X1/8 LB | BRINE TANK | | SOFTENER CAP | | LBS SALT PER REGEN | | FLOW RATE | | WGHT | PRICE |
|----------|-------------|-----------|-----------|----------------|----------------------|------------|-----|--------------|------|--------------------|-----|-----------|-----|------|-------|
| | | | | | | MAX | MIN | MAX | MIN | MAX | MIN | SRVC | BKW | | |
| 43404 | DWC902850M | 1 1/2" | 14X65 | 3 | 60 | 24X41 | 500 | 90K | 60K | 45 | 18 | 21 | 5 | 245 | |
| 43405 | DWC1202850M | 1 1/2" | 16X65 | 4 | 80 | 24X41 | 500 | 120K | 80K | 60 | 24 | 28 | 7 | 325 | |
| 65662 | DWC1502850M | 1 1/2" | 18X65 | 5 | 100 | 24X41 | 500 | 150K | 100K | 75 | 30 | 43 | 11 | 385 | |
| 43406 | DWC1802850M | 1 1/2" | 20X62 | 6 | 100 | 24X41 | 500 | 180K | 120K | 90 | 48 | 44 | 13 | 484 | |
| 43407 | DWC2102850M | 1 1/2" | 20X62 | 7 | 100 | 24X41 | 500 | 210K | 140K | 105 | 56 | 44 | 13 | 590 | |
| 43408 | DWC2402850M | 1 1/2" | 24X60 | 8 | 160 | 24X41 | 500 | 240K | 160K | 120 | 64 | 44 | 15 | 653 | |
| 43409 | DWC3002850M | 1 1/2" | 24X72 | 10 | 200 | 24X50 | 600 | 300K | 200K | 150 | 80 | 44 | 15 | 715 | |
| 43410 | DWC3602850M | 1 1/2" | 30X72 | 12 | 240 | 24X50 | 600 | 360K | 240K | 180 | 96 | 44 | 15 | 820 | |



Products for Quality Water

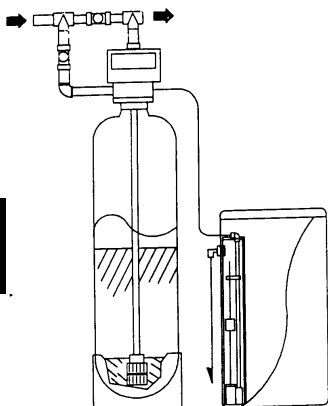

COMMERCIAL FLECK 2900 WATER SOFTENER

FIBERGLASS

TDS, application and flow rates will influence the performance of the system.

| FIG. NO. | MODEL # | PIPE SIZE | MINERAL TANK | | BRINE TANK | | SOFTENING CAPACITY | | LBS SALT PER GENER | | FLOW RATE GPM | | WGHT | PRICE |
|----------|---------|-----------|--------------|--------------|------------------|-------|--------------------|---------|--------------------|-----|---------------|------|------|-------|
| | | | TANK SIZE | RESIN CU FT. | Gravel 1/4 x 1/8 | SIZE | SALT FILL | MAX | MIN | MAX | MIN | SRVC | | |
| 40889 | DWC 90 | 2 | 14X65 | 3 | 50 | 24X41 | 500 | 90,000 | 60,000 | 45 | 18 | 34 | 9 | 240 |
| 40890 | DWC 120 | 2 | 16X65 | 4 | 50 | 24X41 | 500 | 120,000 | 90,000 | 60 | 24 | 39 | 10 | 320 |
| 48800 | DWC 150 | 2 | 18X65 | 5 | 50 | 24X41 | 500 | 150,000 | 100,000 | 75 | 30 | 43 | 11 | 380 |
| 39994 | DWC 180 | 2 | 21X62 | 6 | 75 | 24X41 | 500 | 180,000 | 120,000 | 90 | 36 | 52 | 13 | 480 |
| 39995 | DWC 210 | 2 | 21X62 | 7 | 75 | 24X41 | 500 | 210,000 | 140,000 | 105 | 42 | 52 | 13 | 585 |
| 39996 | DWC 240 | 2 | 24X60 | 8 | 100 | 24X41 | 500 | 240,000 | 160,000 | 120 | 48 | 62 | 15 | 625 |
| 40891 | DWC 300 | 2 | 24X72 | 10 | 100 | 24X50 | 600 | 300,000 | 200,000 | 150 | 60 | 62 | 15 | 710 |
| 40892 | DWC 360 | 2 | 30X72 | 12 | 150 | 24X50 | 600 | 360,000 | 240,000 | 170 | 75 | 65 | 18 | 1010 |
| 78329 | DWC 450 | 2 | 30X72 | 15 | 200 | 30X48 | 900 | 450,000 | 300,000 | 225 | 90 | 70 | 25 | 1160 |
| - | DWC 600 | 2 | 36X72 | 20 | 300 | 30X48 | 900 | 600,000 | 400,000 | 300 | 120 | 82 | 35 | 1510 |

COMMERCIAL FLECK 3150 WATER SOFTENERS FIBERGLASS

| FIG. NO. | MODEL # | PIPE SIZE | TANK SIZE | RESIN CU FT | GRAVEL | | BRINE | | SOFTENER | | LBS SALT | | FLOW RATE | WGHT | PRICE |
|----------|---------------|-----------|-----------|----------------|------------|-------|-------|------|----------|-----|-----------|-----|--------------|------|-------|
| | | | | | 1/4X1/8 LB | | TANK | | CAP | | PER REGEN | | | | |
| | | | | | MAX | MIN | MAX | MIN | MAX | MIN | SRVC | BKW | | | |
| 58541 | DWC3003150 | 2" | 24X72 | 10 | 100 | 24X50 | 600 | 300K | 200K | 150 | 80 | 62 | 15 | 730 | |
| 60419 | DWC4503150 | 2" | 30X72 | 15 | 200 | 30X48 | 900 | 450K | 300K | 225 | 90 | 98 | 25 | 1105 | |
| 63692 | DWC6003150 | 2" | 36X72 | 20 | 300 | 39X48 | 1500 | 600K | 400K | 300 | 120 | 120 | 35 | 1500 | |
| 63720 | DWC7203150 | 2" | 36X72 | 24 | 300 | 42X60 | 2500 | 720K | 480K | 360 | 144 | 120 | 40 | 1750 | |
| 63605 | DWC9003150 | 2" | 42X72 | 30 | 400 | 42X60 | 2500 | 900K | 600K | 450 | 180 | 120 | 45 | 2150 | |
| 54171 | DWC3003150MP* | 2" | 24X72 | 10 | 100 | 24X50 | 600 | 300K | 200K | 150 | 80 | 62 | 15 | 745 | |
| 67366 | DWC4503150MP* | 2" | 30X72 | 200 | 200 | 30X48 | 900 | 450K | 300K | 225 | 90 | 98 | 25 | 1120 | |
| 81516 | DWC6003150MP* | 2" | 36X72 | 300 | 300 | 39X48 | 1500 | 600K | 400K | 300 | 120 | 120 | 35 | 1515 | |
| 81518 | DWC7203150MP* | 2" | 36X72 | 300 | 300 | 42X60 | 2500 | 720K | 480K | 360 | 144 | 120 | 40 | 1765 | |

* metered

COMMERCIAL FLECK 3900 WATER SOFTENERS FIBERGLASS

| FIG. NO. | MODEL # | PIPE SIZE | TANK SIZE | RESIN CU FT | GRAVEL | | BRINE | | SOFTENER | | LBS SALT | | FLOW RATE | WGHT | PRICE |
|----------|------------|-----------|-----------|----------------|------------|-------|-------|------|----------|-----|-----------|-----|--------------|------|-------|
| | | | | | 1/4X1/8 LB | | TANK | | CAP | | PER REGEN | | | | |
| | | | | | MAX | MIN | MAX | MIN | MAX | MIN | SRVC | BKW | | | |
| 40819 | DWC3002900 | 3" | 24X72 | 10 | 100 | 30X48 | 900 | 300K | 200K | 150 | 80 | 63 | 15 | 1070 | |
| 81519 | DWC3003900 | 3" | 30X72 | 15 | 200 | 30X48 | 900 | 450K | 300K | 225 | 90 | 98 | 25 | 1597 | |
| 68794 | DWC6003900 | 3" | 36X72 | 20 | 250 | 50X60 | 4000 | 600K | 400K | 300 | 120 | 140 | 35 | 2015 | |
| 81521 | DWC7503900 | 3" | 42X72 | 25 | 300 | 39X48 | 1500 | 750K | 500K | 360 | 144 | 165 | 40 | 3245 | |
| 81522 | DWC9003900 | 3" | 48X72 | 30 | 400 | 42X60 | 2500 | 900K | 600K | 450 | 180 | 190 | 45 | 4295 | |

COMMERCIAL FLECK 3900 METERED WATER SOFTENERS

| FIG. NO. | MODEL # | PIPE SIZE | TANK SIZE | RESIN CU FT | GRAVEL | | BRINE | | SOFTENER | | LBS SALT | | FLOW RATE | WGHT | PRICE |
|----------|-------------|-----------|-----------|----------------|------------|-------|-------|------|----------|-----|-----------|-----|--------------|------|-------|
| | | | | | 1/4X1/8 LB | | TANK | | CAP | | PER REGEN | | | | |
| | | | | | MAX | MIN | MAX | MIN | MAX | MIN | SRVC | BKW | | | |
| 81523 | DWC3003900M | 3" | 24X72 | 10 | 100 | 30X48 | 900 | 300K | 200K | 150 | 80 | 63 | 15 | 1077 | |
| 68037 | DWC4503900M | 3" | 30X72 | 15 | 200 | 30X48 | 900 | 450K | 300K | 225 | 90 | 98 | 25 | 1604 | |
| 67215 | DWC6003900M | 3" | 36X72 | 20 | 250 | 50X60 | 4000 | 600K | 400K | 300 | 120 | 140 | 35 | 2022 | |
| 67216 | DWC7503900M | 3" | 42X72 | 25 | 300 | 39X48 | 1500 | 750K | 500K | 360 | 144 | 165 | 40 | 3252 | |
| 81524 | DWC9003900M | 3" | 48X72 | 30 | 400 | 42X60 | 2500 | 900K | 600K | 450 | 180 | 190 | 45 | 4302 | |

METERED INITIATED TWIN TANK CONDITIONERS

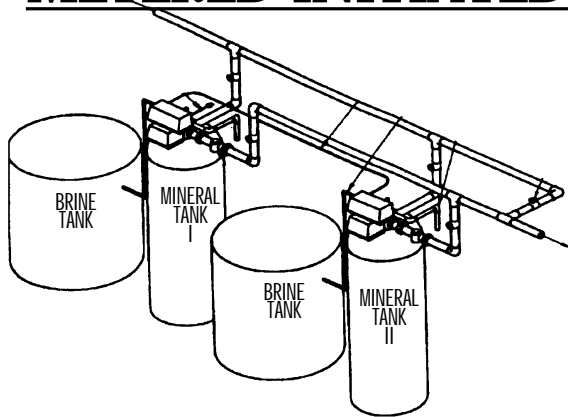

FLECK 2900 2" TOP MOUNT VALVE: SYSTEM 5

SYSTEM #5 interlock - typical twin tank installation with optional meter interlock and no hard water bypass.

| FIG. NO. | GRAIN CAPACITY | TANK SIZE | RESIN CF* | BRINE TANK | FLOW RATE | | | BW* | PRICE |
|----------|----------------|-----------|-----------|------------|-----------|-----|-----|-----|-------|
| | | | | | SALT FILL | SVC | PK | | |
| 44164 | 120,000 | (2)15X65 | 4.0 | (2)24X41 | 700 | 40 | 125 | 7 | |
| 44167 | 180,000 | (2)21X62 | 6.0 | (2)24X50 | 800 | 60 | 154 | 10 | |
| 44169 | 210,000 | (2)21X62 | 7.0 | (2)24X50 | 800 | 70 | 146 | 10 | |
| 44171 | 240,000 | (2)24X71 | 8.0 | (2)24X50 | 800 | 80 | 172 | 15 | |
| 44173 | 300,000 | (2)24X71 | 10.0 | (2)24X50 | 800 | 100 | 186 | 15 | |
| 44175 | 360,000 | (2)24X71 | 11.0 | (2)24X50 | 800 | 110 | 164 | 15 | |

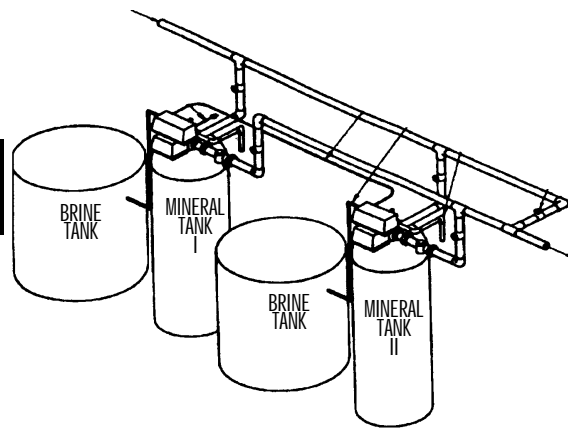

FLECK 2900 2" TOP MOUNT VALVE: SYSTEM 7

Standard Features: 2 tanks, 1 meter, alternator system. One unit in service, the other is on stand-by. When the meter goes into a regeneration cycle, the standby unit goes into service.

| FIG. NO. | GRAIN CAPACITY | TANK SIZE | RESIN CF* | BRINE TANK | FLOW RATE | | | BW* | PRICE |
|----------|----------------|-----------|-----------|------------|-----------|-----|----|-----|-------|
| | | | | | SALT FILL | SVC | PK | | |
| 44165 | 120,000 | (2)16X65 | 4.0 | 24X41 | 700 | 20 | 64 | 7 | |
| 44166 | 180,000 | (2)21X62 | 6.0 | 24X50 | 800 | 30 | 77 | 10 | |
| 44168 | 210,000 | (2)21X62 | 7.0 | 24X50 | 800 | 35 | 73 | 10 | |
| 44170 | 240,000 | (2)24X71 | 8.0 | 24X50 | 800 | 40 | 86 | 15 | |
| 44172 | 300,000 | (2)24X71 | 10.0 | 24X50 | 800 | 50 | 93 | 15 | |
| 44174 | 360,000 | (2)24X71 | 11.0 | 24X50 | 800 | 55 | 82 | 15 | |

9000 SERIES WATER SOFTENERS

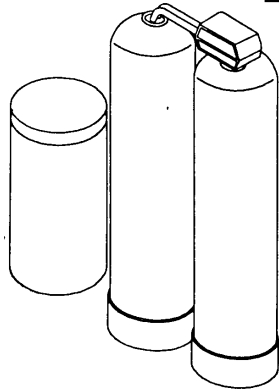

| FIG. NO. | DESCR | SPACE REQ'D LXW | PIPE SIZE | WEIGHT | PRICE |
|----------|-------|--------------------|-----------|--------|-------|
| 40893 | DT91 | 38X20 | 3/4" MTR | 175# | |
| 43425 | DT91F | 38X20 | 1" MTR | 175# | |
| 40000 | DT92 | 40X20 | 3/4" MTR | 230# | |
| 43426 | DT92F | 40X20 | 1" MTR | 230# | |
| 40894 | DT93 | 40X20 | 3/4" MTR | 290# | |
| 43427 | DT93F | 40X20 | 1" MTR | 290# | |
| 40002 | DT94 | 46X20 | 3/4" MTR | 400# | |
| 43428 | DT94F | 46X20 | 1" MTR | 400# | |
| 40003 | DT95 | 48X20 | 3/4" MTR | 460# | |
| 43429 | DT95F | 48X20 | 1" MTR | 460# | |
| 43430 | DT96F | 58X26 | 1" MTR | 500# | |
| 40004 | DT96 | 58X26 | 3/4" MTR | 500# | |

NOTE: DT95 and smaller units are also available with the 1" extended range meter, less bypass. DT96 and larger units are also available with 3/4" standard range meters and 1" bypass. Allow 4 hours run time between regenerations for good brining

| MODEL | Resin Tanks (2 per system) | | | SALT TANK | | SOFTENING CAPACITY | | SALT/ REGEN | | FLOW RATE | | | MTR | BYPASS | PIPE SIZE |
|-------|-------------------------------|-----|-----|-----------|--------------|-----------------------|-----|----------------|-----|-----------|------|---------------|------|--------|--------------|
| | DXH | CF | #20 | DXH | SALT FILL | MAX | MIN | MAX | MIN | C/P | BW | PRESS DROP | | | |
| DT91 | 8X35 | .5 | 10 | 18X40 | 400 | 15K | 10K | 8 | 4 | 7/8.7 | 1.75 | 12 | 3/4" | YES | 3/4" |
| DT92 | 9X48 | 1 | 15 | 18X40 | 400 | 30K | 20K | 15 | 6 | 8.8/11 | 2.2 | 12 | 3/4" | YES | 3/4" |
| DT93 | 10X54 | 1.5 | 20 | 18X40 | 400 | 45K | 30K | 22.5 | 9 | 10/13 | 2.7 | 15 | 1" | NO | 1" |
| DT94 | 12X52 | 2 | 30 | 18X40 | 400 | 60K | 40K | 30 | 12 | 15/19 | 4 | 12 | 3/4" | YES | 3/4" |
| DT95 | 13X54 | 2.5 | 45 | 18X40 | 400 | 75K | 50K | 38 | 15 | 17/21 | 4.5 | 15 | 3/4" | YES | 3/4" |
| DT96 | 14X65 | 3 | 60 | 24X41 | 600 | 90K | 60K | 45 | 18 | 17/21 | 5.0 | 15 | 1" | NO | 1" |

PRESSURE DROPS ARE AT SERVICE FLOW RATES INDICATED WITH AN 80 PSI RAW WATER SUPPLY

| 3/4" METER | STD. RANGE | 125-2100 Gal | 1" METER | STD. RANGE | 360-5100 Gal |
|------------|------------|---------------|----------|------------|----------------|
| | EXT. RANGE | 625-10500 Gal | | EXT. RANGE | 1800-25500 Gal |

NOTE: Units with 3/4" meter have 1" - 5600 bypass
Units with 1" meter have no bypass

REMEMBER: 9000 VALVE USES SOFT WATER TO REGENERATE. SUBTRACT REGENERANT WATER FROM TOTAL

NOTE: TDS, application and flow rates will influence the performance of the system.

9500 SERIES WATER SOFTENERS

TWIN TANK ALTERNATING SOFTENER

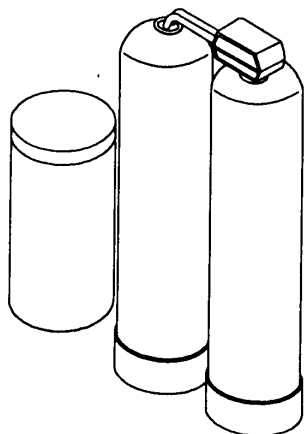

| FIG. NO. | DESCR | PIPE SIZE | WEIGHT | PRICE |
|----------|---------|-----------|--------|-------|
| 47882 | DT95-4 | 1 1/2 | 370 | |
| 47883 | DT95-6 | 1 1/2 | 550 | |
| 47884 | DT95-8 | 1 1/2 | 720 | |
| 47885 | DT95-10 | 1 1/2 | 900 | |
| 47886 | DT95-12 | 1 1/2 | 1115 | |

COMMERCIAL TWIN TANK ALTERNATING SOFTENER

| FIG NO | MOD # | PIPE SIZE | TANK SIZE | MINERAL TANK | | | BRINE TANK | | SOFTENING CAPACITY | | LBS SALT PER REG | | FLOW RATE GPM | |
|--------|---------|-----------|-----------|--------------|-----------|-----|------------|-----------|--------------------|------|------------------|-----|---------------|-----|
| | | | | RESIN CU FT | 1/4 X 1/8 | #20 | SIZE | SALT FILL | MAX | MIN | MAX | MIN | SERV | BKW |
| 47882 | DT95-4 | 1 1/2 | 12X52 | 2 | | 30 | 24X41 | 500 | 60K | 40K | 30 | 12 | 15 | 4 |
| 47883 | DT95-6 | 1 1/2 | 14X52 | 3 | | 60 | 24X41 | 500 | 90K | 60K | 45 | 18 | 21 | 5 |
| 47884 | DT95-8 | 1 1/2 | 16X65 | 4 | | 80 | 24X41 | 500 | 120K | 80K | 60 | 24 | 27 | 7 |
| 47885 | DT95-10 | 1 1/2 | 20X62 | 5 | | 100 | 24X50 | 600 | 150K | 100K | 75 | 30 | 43 | 11 |
| 47886 | DT95-12 | 1 1/2 | 22X54 | 6 | | 100 | 24X50 | 600 | 180K | 120K | 90 | 36 | 37 | 12 |

For 2350 safety brine valve on DT95-10 and larger, add P/N 05100

NOTE: TDS, application, and flow rates will influence the performance of the system.



Products for Quality Water

SPECIFICATIONS ON RESIDENTIAL AUTOTROL CONTROLS

| FIG. NO. | MODEL # | INLET/ OUTLET | FLOW RATES | MAX BACK- WASH | OPTIONS KEYS | PRICE |
|----------|-------------|------------------|------------|-------------------|-----------------|-------|
| 67734 | A253F | 3/4 | 10 | 7 | b,z | |
| 66483 | A255C | 3/4 | 10 | 7 | b,z | |
| 66495 | A255MP | 3/4 | 10 | 7 | e,m,b,z | |
| 73123 | A255940 | 3/4 | 10 | 7 | e,m,b,z | |
| 67825 | A255960 | 3/4 | 10 | 7 | e,m,b,z | |
| 66492 | A163C | 1 | 10 | 6 | b,y,f,m | |
| 57369 | A163C24volt | 1 | 10 | 6 | b,y,f,m | |
| 66494 | A168FA | 1 | 10 | 6 | b,y | |
| 66493 | A168C | 1 | 10 | 6 | b,y | |
| 67835 | A168LR | 1 | 10 | 6 | b,y | |
| 67829 | A168MP | 1 | 10 | 6 | e,m,b,y | |
| 66498 | A168LRMP | 1 | 10 | 6 | e,m,b,y | |

All valves are top mount (TM) except the 172 and 182. The 180 is side mount (SM) also.

Time clock controls are available in either 6 day or 7 day version.

Alternating and interlock systems are available with commercial control valves with the 480 DDS controller.

Continuous flow rate based on 15 psi pressure drop (50 psi inlet w/ largest recommended softener tank. Peak may require service valves.)

Back wash rate based on 25 psi pressure drop on largest recommended softener tank.

- 1) 6 or 7 day control timer.
- 2) 120 minutes timer standard, 60 minutes available, WS (water saving) option available.
- 3) 5 GPM through valve, 10 gpm with auxiliary backwash.
- 4) Back wash 4-15 minutes. All other cycles adjusted automatically by micro-processor.
- 5) 6,7, or 24 day clock options.
- 6) Twin alternating system.
- 7) Exclusive variable reserve demand system.
- 8) Calendar override feature.
- 9) Time of regeneration and brine fill only.

OPTIONS KEYS

- b = Bypass valve
- e = Electronic timer
- f = Backwash filter
- m = Meter initiated regeneration
- s = Service valve operator
- u = Upflow regeneration
- y = 3/4" Inlet/Outlet
- z = 1" Inlet/Outlet

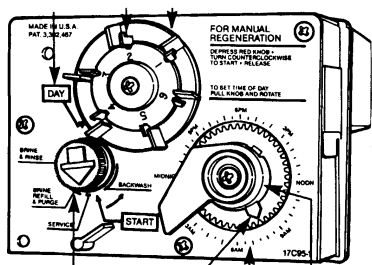

**SERIES 255 VALVE
440 CONTROL**

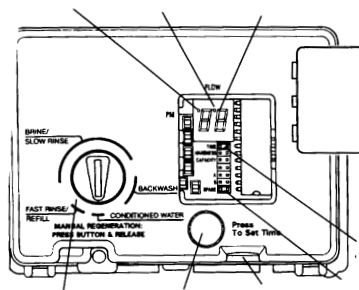

**SERIES 255 VALVE
460i CONTROL**

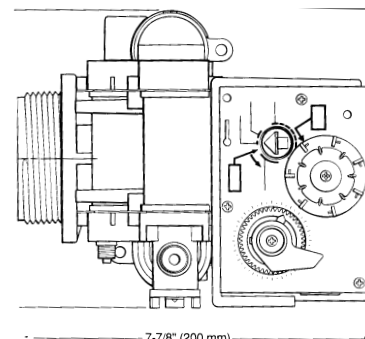

**168 VALVE WITH 440
TIMER**

AUTOTROL REPLACEMENT PARTS - 255 SERIES

Valve Body

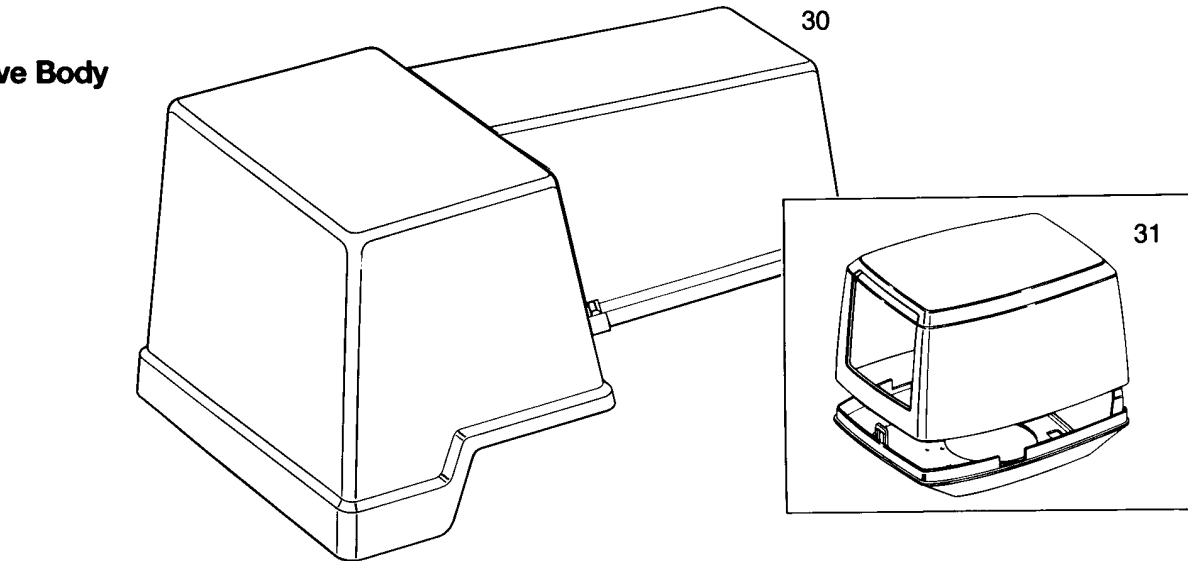

Tank Adapter Module

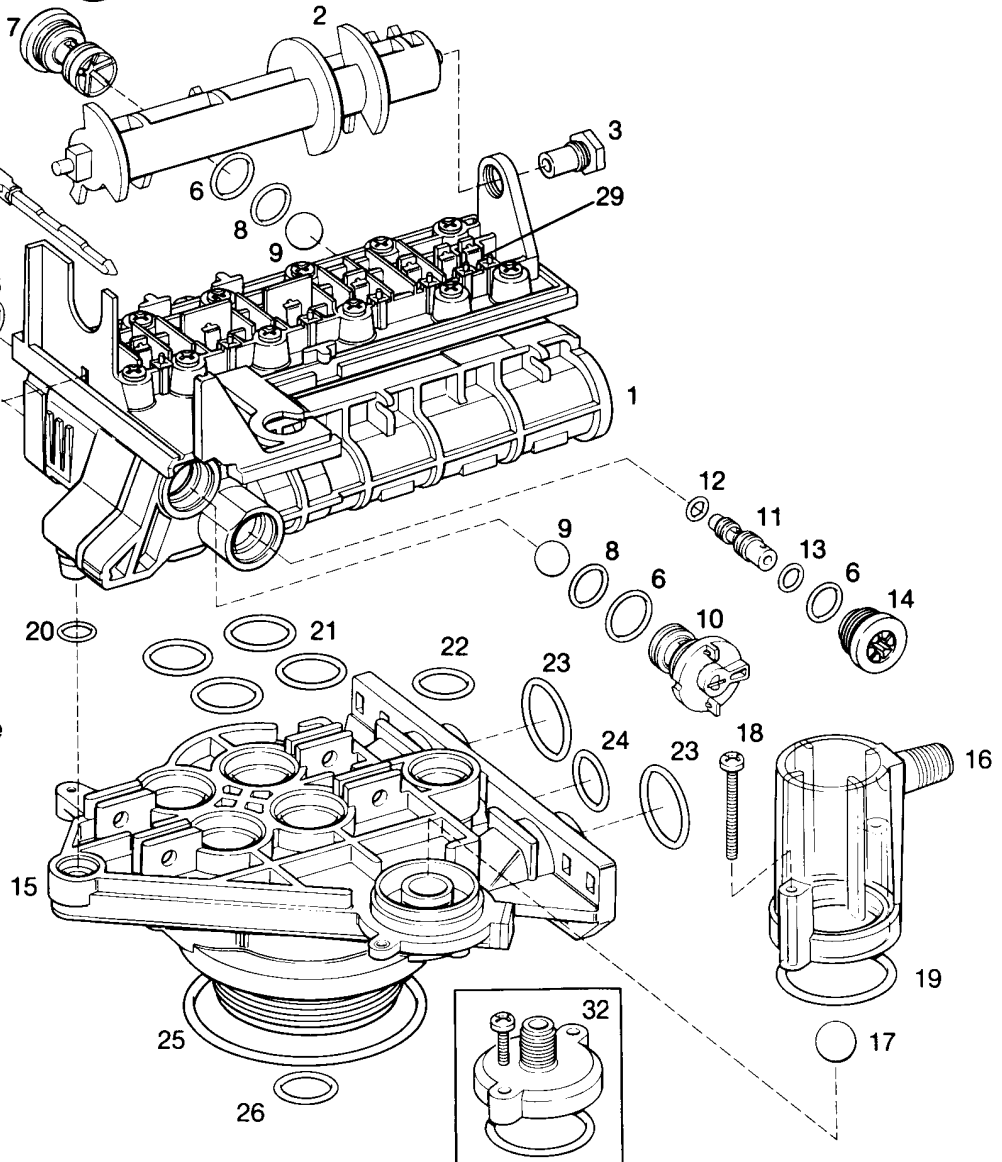

AUTOTROL REPAIR PARTS - SERIES 255

| ITEM # | FIG. NO. | PART # | DESCRIPTION | PRICE |
|--------|----------|--------|--|-------|
| 2 | 33981 | 21F | Standard, one piece | |
| 2 | 33982 | 21F-1 | Extra salt, segmented | |
| 2 | 33983 | 21F-2 | Long rinse, segmented | |
| 3 | 33985 | 22F | Camshaft bearing | |
| 4 | 33967 | 5F | Timer locking pin | |
| 5 | 33431 | 7F | Screen/cap assembly with O-ring | |
| 6 | 33964 | 2F | O-ring EP | |
| 7 | 33990 | 25F-6 | Drain control assembly with O-rings No. 6 (0.9 gpm; 3.4 lpm) | |
| 7 | 33991 | 25F-7 | Drain control assembly with O-rings No. 7 (1.2 gpm; 4.5 lpm) | |
| 7 | 33992 | 25F-8 | Drain control assembly with O-rings No. 8 (.6 gpm; 6.1 lpm) | |
| 7 | 33993 | 25F-9 | Drain control assembly with O-rings No. 9 (2.09 gpm; 7.6 lpm) | |
| 7 | 33994 | 25F-10 | Drain control assembly with O-rings No. 10 (2.5 gpm; 9.5 lpm) | |
| 7 | 33995 | 25F-12 | Drain control assembly with O-rings No. 12 (3.5 gpm; 13.2 lpm) | |
| 7 | 68117 | 25F-13 | Drain control assembly with O-rings No. 13 (4.1 gpm; 15.5 lpm) | |
| 7 | 67678 | 25F-14 | Drain control assembly with O-rings No. 14 (4.8 gpm; 18.2 lpm) | |
| 8 | 33965 | 3F | O-ring EP | |
| 9 | 33966 | 4F | Ball, flow control | |
| 10 | 63531 | 1F-10 | Brine refill control 1 to 10 lbs salt | |
| 10 | 48428 | 1F-19 | Brine refill control 3 to 19 lbs salt | |
| 11 | 33432 | 28F-AA | Injector assembly with O-rings: "A" injector - white | |
| 11 | 33433 | 28F-BB | Injector assembly with O-rings: "B" injector - blue | |
| 11 | 33434 | 28F-CC | Injector assembly with O-rings: "C" injector - red | |
| 12 | 33996 | 26F | O-ring EP | |
| 13 | 33997 | 27F | O-Ring EP | |
| 14 | 33969 | 8FAA | Injector cap with O-ring "A" cap | |
| 14 | 33970 | 8FBB | Injector cap with O-ring "B" cap | |
| 14 | 33971 | 8FCC | Injector cap with O-ring "C" cap | |
| 17 | 50229 | 36F | Air check housing | |
| 19 | 34000 | 32F | O-ring EP | |
| 21 | 34003 | 35F | O-ring BN | |
| 22 | 34004 | 37F | O-ring BN | |
| 23 | 34005 | 38F | O-ring BN | |
| 24 | 34006 | 39F | O-ring BN | |
| 25 | 34009 | 43F | O-ring BN | |
| 26 | 34010 | 44F | O-ring EP | |
| 27 | 34002 | 34F | Locking Bar: English Language | |
| 28 | 34001 | 33F | Screw, No. 8x9/16 in | |
| 29 | 75362 | 23F | Spring valve flapper kit | |
| 30 | 33979 | 20F-1 | Valve, cover, standard, black | |

AUTOTROL REPAIR PARTS - A163/168 VALVE

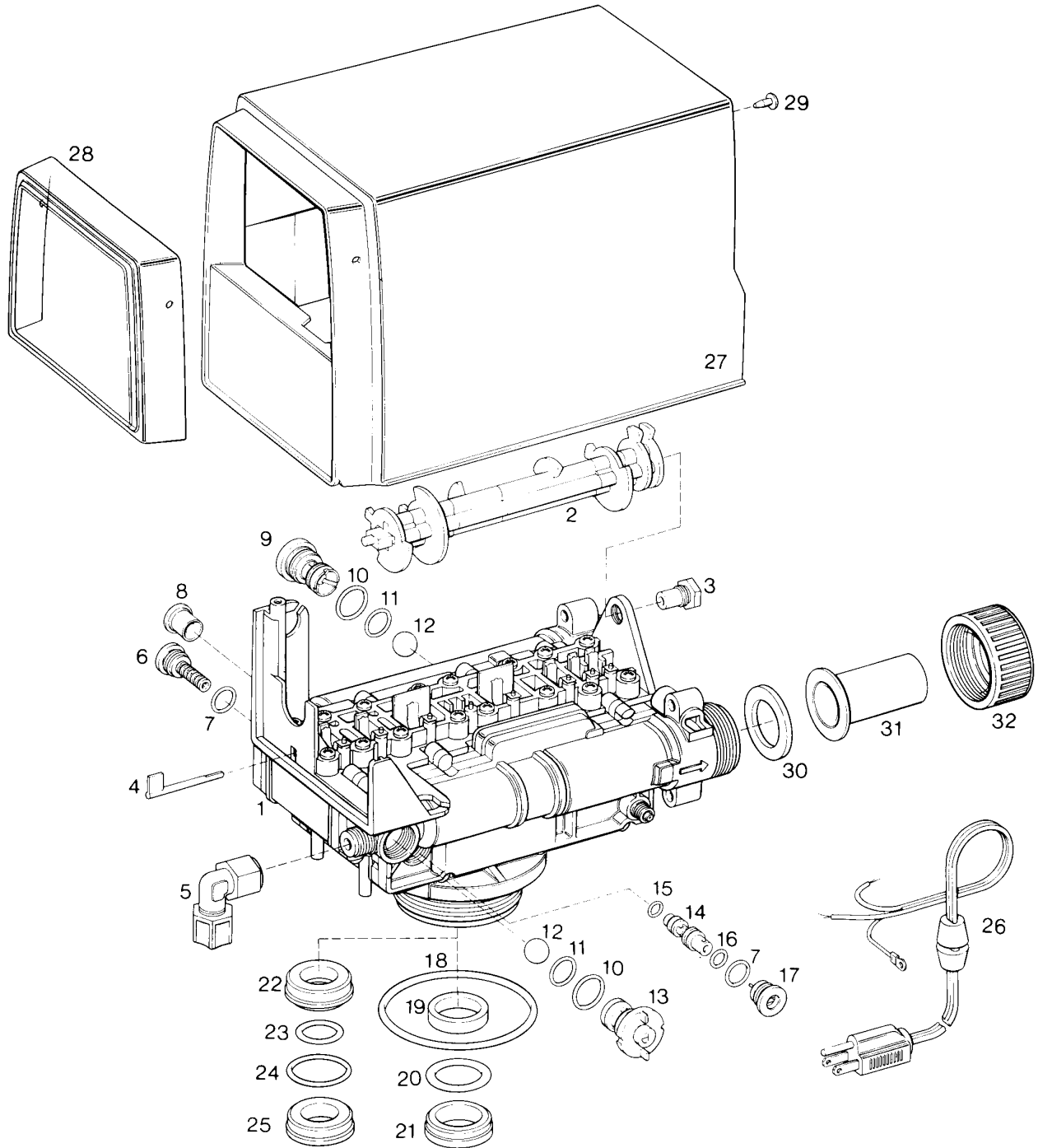

AUTOTROL REPAIR PARTS - A163/168 VALVE

| CODE | FIG. NO. | DESCRIPTION | QTY | PRICE |
|------|----------|--|-----|-------|
| 1 | | Valve body assembly | 1 | |
| | 34059 | w/ 1 in riser adapter | | |
| | 34050 | w/ 1 3/16 in riser adapter | | |
| 2 | | Camshaft assembly | 1 | |
| | 44113 | standard camshaft | | |
| | 48909 | extra salt camshaft | | |
| | 44114 | long rise camshaft | | |
| 3 | 33985 | Camshaft bearing | 1 | |
| 4 | 33967 | Timer locking pin | 1 | |
| 5 | | Elbow connector | 1 | |
| 6 | 34054 | Screen cap w/ O-ring | 1 | |
| 7 | 33968 | O-ring | 2 | |
| 8 | | Plug | 1 | |
| 9 | | Backwash control w/ O-ring | 1 | |
| | 33990 | No. 6 for 6 in diameter tank | | |
| | 33991 | No. 7 for 7 in diameter tank | | |
| | 33992 | No. 8 for 8 in diameter tank | | |
| | 33993 | No. 9 for 9 in diameter tank | | |
| | 33994 | No. 10 for 10 in diameter tank | | |
| | 33995 | No. 12 for 12 in diameter tank | | |
| 10 | 33964 | O-ring | 2 | |
| 11 | 33965 | O-ring | 2 | |
| 12 | 33966 | Ball | 2 | |
| 13 | | Brine refill control | 1 | |
| | 36231 | 1 to 10 lbs. salt | | |
| | 48428 | 3 to 19 lbs. salt | | |
| 14 | | Injector w/ O-rings | 1 | |
| | 33432 | "A" injector, white | | |
| | 33433 | "B" injector, blue | | |
| | 33434 | "C" injector, red | | |
| 15 | 33996 | O-ring | 1 | |
| 16 | 33997 | O-ring | 1 | |
| 17 | | Injector cap w/ O-ring | 1 | |
| | 33969 | "A" cap | | |
| | 33970 | "B" cap | | |
| | 33971 | "C" cap | | |
| 18 | 34009 | O-ring | 1 | |
| 26 | 34072 | Cord set, flat (SPT-2) | 1 | |
| 30 | 33249 | Gasket for 3/4 in or 1 in pipe or tube | 1 | |
| | 33031 | For 1 in pipe or tube | | |
| 31 | | Plumbing adapter | 1 | |
| | 34031 | 3/4 in copper tube | | |
| | 34032 | 1 in. copper tube | | |
| | 34033 | 1 in. NPT, brass | | |
| | 34034 | 3/4 in. BSPT, Brass | | |
| | 34035 | 1 in. BSPT pipe | | |
| | 44116 | 3/4 in. PVC pipe | | |
| | 44117 | 1 in. PVC pipe | | |
| | | Adapter nut: | | |
| 32 | 33250 | For 3/4 in. copper tube | 1 | |
| | 34036 | For 1 in. copper tube | | |
| | 34037 | For 3/4 in. pipe | | |
| | 34038 | For 1 in. pipe | | |

AUTOTROL REPAIR PARTS - 440 TIMER

440 Timer

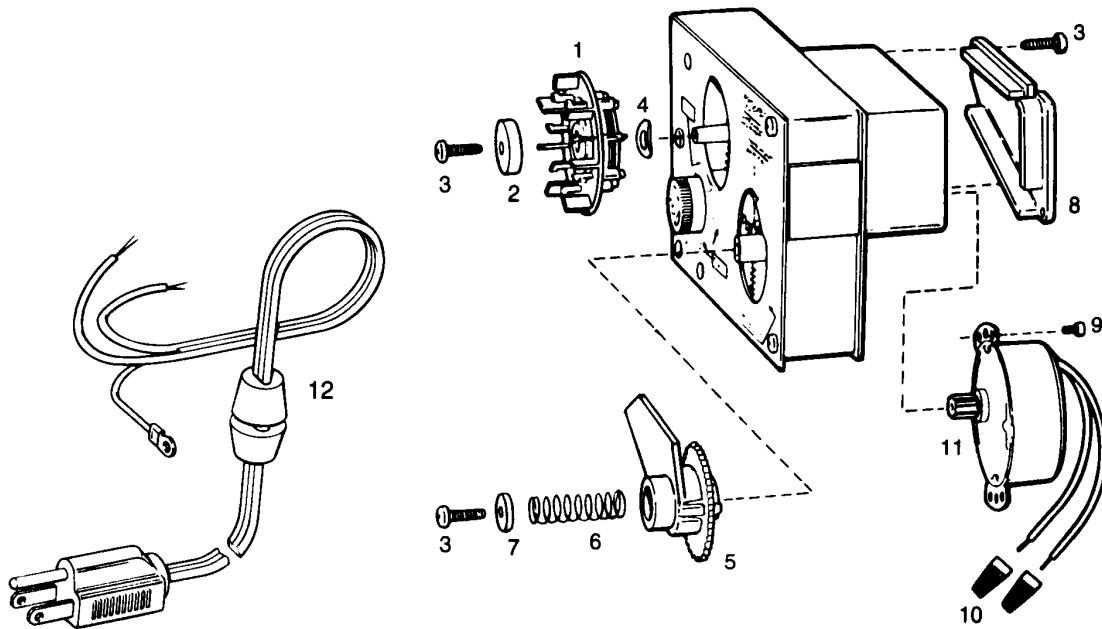

Bypass Valve

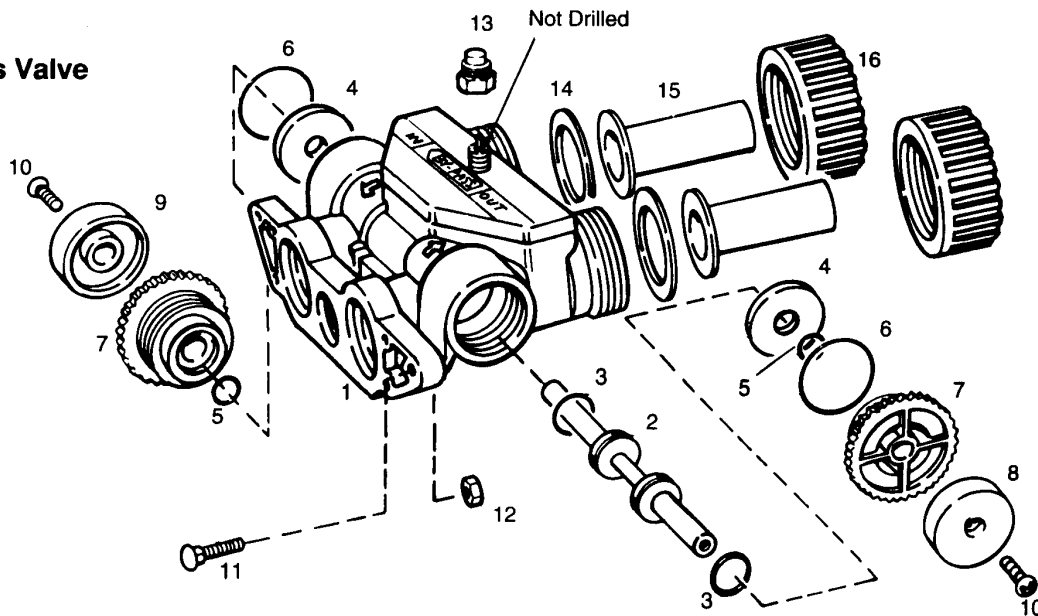

Piping Boss

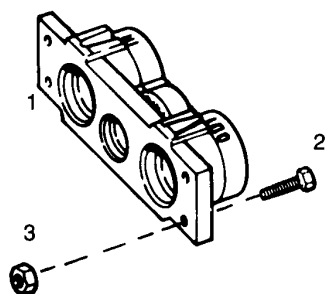

Note: Do not use pipe joint compound when threading pipe into the Noryl piping boss. Use only Teflon® pipe tape. Do not overtighten pipe into Noryl piping boss.

* Teflon is a registered Trademark of E. I. Dupont and Co.

AUTOTROL REPAIR PARTS - 440 TIMER

| FIG. NO. | PART # | DESCRIPTION | QTY | PRICE |
|---------------------|--------|---|-----|-------|
| 1 | | Skipper wheel assembly | 1 | |
| | 33974 | 6-day | 1 | |
| | 33975 | 7-day | 1 | |
| 2 | 34071 | Washer | 1 | |
| 3 | 34068 | Screw, no. 6 x 1/2 in | 1 | |
| 4 | 33977 | Bowed washer | 1 | |
| 5 | 34075 | Tripper arm assembly | 1 | |
| 6 | 34069 | Spring | 1 | |
| 7 | 34070 | Retainer | 1 | |
| 8 | | Motor cover A1031751 | 1 | |
| 9 | | Screw, no. 4-40 x 1/4 in A1005615 | 1 | |
| 10 | | Wire nut A1007483 | 1 | |
| 11 | | Motor: | 1 | |
| | 42939 | 115V, 60Hz | 1 | |
| | 51098 | 24V, 60Hz | 1 | |
| 12 | | Cord Set, Flat (SPT-2) | 1 | |
| PIPING BOSS | | | | |
| 1 | 27373 | 3/4 in NPT, brass | 1 | |
| | 44118 | 1 in NPT, brass | 1 | |
| | 27374 | 3/4 in NPT, Noryl | 1 | |
| | 44115 | 1 in NPT, Noryl | 1 | |
| BYPASS VALVE | | | | |
| 1 | | Bypass body assembly A1033638 | 1 | |
| 2 | 49649 | Valve stem with O-rings | 1 | |
| 3 | 48834 | O-ring | 2 | |
| 4 | 34025 | Washer | 2 | |
| 5 | 34023 | O-ring | 2 | |
| 6 | 34024 | O-ring | 2 | |
| 7 | 34017 | End cap | 2 | |
| 8 | 34012 | Knob, black | 21 | |
| 9 | 34011 | Knob, white | 1 | |
| 10 | | Screw, No. 8 x 9/16 in A33F -or- A1006093 | 2 | |
| 11 | 34028 | Screw, No. 10 -24x1 in | 4 | |
| 12 | 34029 | Nut, No. 10 -24 | 4 | |
| 14 | 33249 | Gasket for 1 in pipe or tube | 2 | |
| 15 | 34031 | Plumbing adapter 3/4 in copper tube | 2 | |
| | 34032 | Plumbing adapter 1 in copper tube | 2 | |
| | 34033 | Plumbing adapter 1 in NPT brass | 2 | |
| | 34034 | 3/4 in BSPT, brass | 2 | |
| | 34035 | 1 in BSPT, brass | 2 | |
| 16 | 33250 | Adapter nut for 3/4 in copper tube | 2 | |
| | 34036 | Adapter nut for 1 in copper tube | 2 | |
| | 34037 | Adapter nut for 3/4 in pipe or PVC | 2 | |
| | 34038 | Adapter nut for 1 in pipe or PVC | 2 | |

DUFF CO.

WATER TREATMENT

AUTOTROL COMMERCIAL SERIES SOFTENER/FILTER CONTROL VALVES

MAGNUM Cv

High performance Cv series control valves

| FIG. NO. | MODEL # | INLET/ OUTLET | FLOW RATE | BACK WASH | OPTION KEYS | PRICE |
|----------|---------------|------------------|-----------|-----------|----------------|-------|
| 46856 | A172C | 2 | 100/170 | 30 | e,f,m,s,q | |
| 47562 | A180C | 1.5 | 61/81 | 15 | e,f,m,s,q | |
| 44526 | A180CT | 1.5 | 61/81 | 15 | e,f,m,s,q | |
| 44527 | A180CS | 1.5 | 61/81 | 15 | e,f,m,s,q | |
| 50516 | A180ST2 | 1.5 | 61/81 | 15 | e,f,m,s,q | |
| 47563 | A182C | 2 | 115/147 | 50 | e,f,m,s,q | |
| 50628 | A182SM480 | 2 | 115/147 | 50 | e,f,m,s,q | |
| 62445 | MagnumCv942 | 1.5 | 75 | 45 | e,f,m,s,u,q | |
| 62446 | MagnumCv962 | 1.5 | 75 | 45 | e,f,m,s,u,q | |
| 74598 | Magnum962MTA2 | 1.5 | 75 | 45 | e,f,m,s,u,q | |

OPTIONS KEYS:

e = Electronic Timer
 m = Meter Initiated Regeneration
 u = Uphlow Regeneration

f = Backwash Filter
 s = Service Valve Operator

MAGNUM Cv CONTROLS

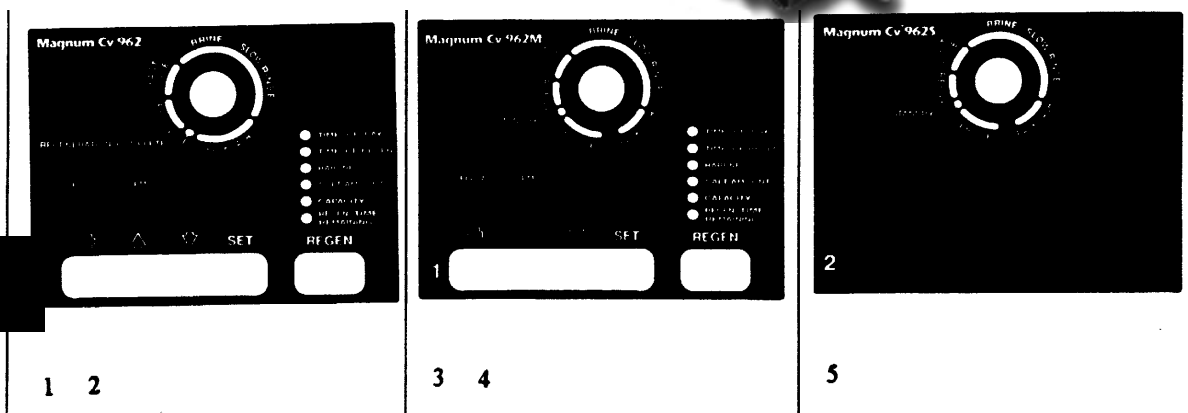

Magnum Cv 962

Magnum Cv 962M

Magnum Cv 962S

| # | DESCRIPTION | FIG. NO. | PRICE |
|----|---|----------|-------|
| 1 | Electronic Control/962 Softener/12 VAC/60 Hz | 75885 | |
| 2 | Electronic Control/962 Softener/Battery Backup/12 VAC/60 Hz | | |
| 3 | Electronic Control/962M Master/12 VAC/60 Hz | 75886 | |
| 4 | Electronic Control/962M Master/Battery Backup/12 VAC/60 Hz | | |
| 5 | Electronic Control/962S Slave/60 Hz | 75889 | |
| 6 | Battery | | |
| 7 | Battery Cap | | |
| 8 | Battery Bracket | | |
| 9 | 12 VAC/60 Hz/150 mA Wall Mount Transformer NW1 | 65079 | |
| 10 | 10 Ft. Hall effect Cable with connector | | |

FLECK CONTROL VALVES

| FIG. NO. | DESCRIPTION | UNIT CTN/LBS | PRICE |
|----------|----------------------------------|--------------|-------|
| 70087 | 5600/1600 softener valve | 6/42 | |
| 77381 | 5600/1600u upflow | 6/42 | |
| 70005 | 5600/1600 3/4" metered valve | 6/42 | |
| 77373 | 5600/1600 SE meter control valve | 6/42 | |
| 70091 | 5600 filter valve | 6/42 | |
| 80972 | 5600 Std. softener valve | 6/42 | |
| 80969 | 5600 Std. softener valve | 6/42 | |
| 80971 | 5600 Std. softener valve | 6/42 | |
| 70092 | 6600/1600 3/4" meter valve | 6/42 | |
| 70093 | 6700/1600 3/4" meter valve | 6/42 | |
| 71878 | 8500 control valve | 1/10 | |
| 70094 | 9000/1600 3/4" meter valve | 1/20 | |
| 70095 | 9000/1600 1" std. meter valve | 1/20 | |
| 70096 | 9500/1600 extended meter valve | 1/40 | |
| 70097 | 9500/1700 extended meter valve | 1/40 | |

FLECK VALVE PART ASSEMBLIES & SERVICE EQUIPMENT

METER RANGES & LABELS

| FIG. NO. | PART # | DESCRIPTION | PRICE |
|----------|--------|------------------------------|-------|
| 71329 | 15959 | 1" Meter 40x100 5,130 g | |
| 51380 | 15970 | 1" Ext. 25x100 26,550 g | |
| 48613 | 15971 | 1-1/2 Ext. 50x1000 53, 125 g | |
| 69071 | 15972 | 2" Meter 21x1000 21,250 g | |
| 48613 | 15973 | 2" Ext. 100x1000 10,625 g | |



Products for Quality Water

FLECK CONTROL VALVES

| FIG. NO. | DESCRIPTION | UNIT CTN/LBS | PRICE |
|----------|-------------------------------------|--------------|-------|
| 70023 | 1500 side mount 3/4" 12 day | 1/13 | |
| 80548 | 1500 side mount 3/4" filter | 1/12 | |
| 70066 | 2500/1600 manual valve | 1/12 | |
| 70025 | 2500/1600 hot water 3/4: 12 day | 1/12 | |
| 74618 | 2500 manual filter valve | 1/12 | |
| 78015 | 2510/1600 softener valve | 4/30 | |
| 79780 | 2510/1600 meter valve | 4/30 | |
| 77787 | 2510 filter valve | 4/30 | |
| 70047 | 2700/1600 softener valve | 1/12 | |
| 70052 | 2700/1600 3/4" ext. meter valve | 1/12 | |
| 46966 | 2700/1600 1" ext meter valve | 1/12 | |
| 70056 | 2750/1600 softener valve | 6/90 | |
| 70059 | 2750/1600 hot water valve | 1/16 | |
| 70060 | 2750/1600 3/4" ext. meter valve | 1/19 | |
| 76970 | 2750/1700 1" ext. meter valve | 1/20 | |
| 70061 | 2750 filter valve | 1/15 | |
| 70062 | 2850/1600 softener valve | 1/25 | |
| 72353 | 2850/1600 hot water valve | 1/25 | |
| 70065 | 2850/1700 softener valve | 1/25 | |
| 70063 | 2850/1600 1" ext. meter valve | 1/28 | |
| 70064 | 2850/1600 1 1/2" ext. meter valve | 1/28 | |
| 70075 | 2850/1700 1" std. meter valve | 1/28 | |
| 70076 | 2850/1700 1 1/2" ext. meter valve | 1/28 | |
| 70077 | 2850 filter valve | 1/24 | |
| 70079 | 2900/1600 softener valve | 1/30 | |
| 70067 | 2900/1700 softener valve | 1/30 | |
| 70080 | 2900/1600 2" ext. meter valve | 1/37 | |
| 70069 | 2900/1700 2" ext. meter valve | 1/37 | |
| 72357 | 2900/1600 system 5 2" meter valve | 1/67 | |
| 70081 | 2900/1600 system 7 2" meter valve | 1/67 | |
| 72359 | 2900/1700 system 5 2" meter valve | 1/67 | |
| 70070 | 2900/1700 system 7 2" meter valve | 1/67 | |
| 70071 | 3150/1800 side mount softener valve | 1/56 | |
| 72390 | 3150/1800 side mount 2" meter valve | 1/68 | |
| 70072 | 3150/1800 top mount softener valve | 1/56 | |
| 70073 | 3150/1800 top mount 2" meter valve | 1/68 | |
| 72392 | 3150 top mount filter valve | 1/56 | |
| 70074 | 3600/1600 softener valve | 9/80 | |
| 72394 | 3600/1600 QC hot water valve | 9/80 | |
| 70378 | 3900/1800 softener valve | 1/100 | |
| 72396 | 3900/1800 side mount softener valve | 1/100 | |
| 72404 | 3900/1800 TM 3" meter valve | 1/107 | |
| 72407 | 3900/1800 system 5 3" meter valve | 1/207 | |
| 72410 | 3900/1800 system 6 3" meter valve | 1/207 | |
| 72412 | 3900/1800 sytem 7 3" meter valve | 1/207 | |
| 72398 | 3900 TM filter valve | 1/95 | |
| 70086 | 5000/1600 softener valve | 6/42 | |
| 70083 | 5000/1600 3/4" standard meter valve | 6/42 | |
| 70100 | 5000 filter valve | 6/42 | |

COMMERCIAL FLECK CONTROL SPECIFICATIONS

| FIG. NO. | CONTROL VALVE | INLET/OUTLET | DRAIN PORT | CYCLES | (1) FLOW RATE | (2) MAX BACKWASH | OPTIONS | PRICE |
|----------|---------------|--------------|------------|--------|---------------|------------------|-------------------------------|-------|
| 70056 | 2750 | 1" | 3/4"M | 5 | 26 | 25 | e, ev, f, h, m, n, o, q, s, u | |
| 70062 | 2850 | 1 1/2" | 1"M | 5 | 51 | 49 | e, ev, f, h, m, n, o, s | |
| 70079 | 2900 | 2" | 3/4"M | 5 | 106 | 25 | e, ev, f, h, m, n, s, u | |
| 70072 | 3150 | 2" | 2"F | 5 | 95 | 105 | e, f, h, m, n, q, s, sm, u | |
| 70378 | 3900 | 3" | 2"F | 5 | 250 | 100 | e, f, h, m, n, s, sm, u | |
| 70095 | 9000 | 3/4"&1" | 1/2"F | 5 | 21 | 85 | b, e, f, h | |
| 70097 | 9500 | 1 1/2" | 1"M | 5 | 43 | 16 | e, f, h | |

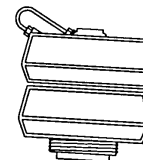
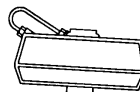
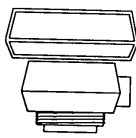
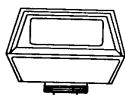

RESIDENTIAL FLECK CONTROL SPECIFICATIONS

| FIG. NO. | CONTROL VALVE | INLET/OUTL;ET | DRAIN PORT | CYCLES | (1) FLOW RATE | (2) MAX BACKWASH | OPTIONS | PRICE |
|----------|---------------|---------------|------------|--------|---------------|------------------|----------------------------|-------|
| 70023 | 1500 | 3/4" | 1/2" F | 5 | 17 | 14 | e, ev, f, h, n, o, s, sm | |
| 78015 | 2510 | 1" | 1/2" F | 5 | 19 | 17 | b, e, ev, f, h, m, n, o, q | |
| 70047 | 2700 | 1" | 1/2" F | 5 | 18 | 15 | e, ev, f, h, m, n, o, q, s | |
| 70074 | 3600 | 3/4" | 1/2" F | 6 | 17 | 6 | b, f, h, q | |
| 70086 | 5000 | 3/4"&1" | 1/2" F | 5 | 21 | 17 | b, f, m, u | |
| 70087 | 5600 | 3/4"&1" | 1/2" F | 6 | 20 | 7 | b, f, m, u | |
| 77373 | 5600SE | 3/4"&1" | 1/2" F | 5 | 20 | 7 | b, f, u | |
| 70092 | 6600 | 3/4"&1" | 1/2" F | 5 | 20 | 7 | b, f, u, v | |
| 70093 | 6700 | 3/4"&1" | 1/2" F | 5 | 20 | 7 | b, f, u, v | |
| 71878 | 8500 | 3/4"&1" | 1/2" F | 5 | 15 | 4 | b, u | |

Time clock and demand regeneration controls available:

Alternating and interlock systems are available with commercial valves:

- 1) Flow rate based on 15 psi pressure drop through valve
- 2) Backwash rate based on 25 psi pressure drop



2500 MANUAL

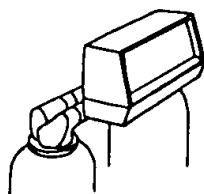

FLECK 9000, 9500

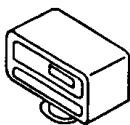

MODEL 6600

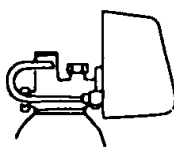

FLECK 2500

OPTION KEY

| | |
|----|------------------------------|
| b | bypass valve |
| e | electronic timer |
| ev | environmental cover |
| f | backwash filter |
| h | hot water |
| m | meter initiated regeneration |
| n | no hard water bypass piston |
| o | manual operation |
| q | quick connect |
| s | service valve operator |
| sm | side mount |
| u | upflow regeneration |
| v | variable brining |

FLECK VALVE PART ASSEMBLIES & SERVICE EQUIPMENT

METER MODULES

| FIG. NO. | PART # | DESCRIPTION | PRICE |
|----------|--------|-------------------------------------|-------|
| 42656 | 60085 | Model 3/4" brass w/ washer | |
| 42657 | 60086 | Model 5600 & 9000 3/4" | |
| 46317 | 14038 | Meter cover assy. std. plastic | |
| 46562 | 15218 | Meter cover assy. std. brass 2" | |
| 44759 | 15237 | Meter cover assy. ext. brass | |
| 46542 | 15150 | meter cover assy ext. range plastic | |

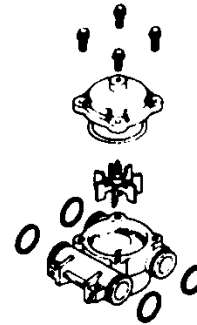

TIMER MOTOR

| FIG. NO. | PART # | DESCRIPTION | PRICE |
|----------|--------|----------------------------|-------|
| 64781 | 10844 | 120 volt/60 hz 3000 series | |
| 48454 | 11590 | 120 volt/60 hz 3600 series | |
| 44755 | 13944 | 120 volt/60 hz 3200 series | |
| 42684 | 18743 | 120 volt/60 hz 5600 series | |
| 50273 | 19659 | 24 volt/60 hz 5600 series | |

PISTON ASSEMBLIES

| FIG. NO. | PART # | DESCRIPTION | PRICE |
|----------|----------|---|-------|
| 38962 | 60090 | Model 1500, 2500 & 2700 piston assembly | |
| 42663 | 60090-HF | Model 2750 & 2900 top piston assembly | |
| 38963 | 60091 | Model 2700 hot water piston assembly | |
| 45584 | 60097 | Model 3600 hot water piston assembly | |
| 45587 | 60105 | Model 2850 piston assy | |
| 42666 | 60104 | Model 2900 piston assy no hard water black | |
| 42665 | 60103 | Model 2900 piston assy standard white | |
| 45580 | 60092 | Model 3100 piston assembly | |
| 45588 | 60106 | Model 3150, -00, -10, -20 | |
| 45583 | 60096 | Model 3600 piston assembly | |
| 51384 | 60102-10 | Model 5600 piston assembly black for filter | |
| 42664 | 60102 | Model 5600 piston assembly = white for softener | |
| 42667 | 60400 | Model 9000 piston assembly - upper | |
| 42668 | 60401 | Model 9000 piston assembly - lower | |

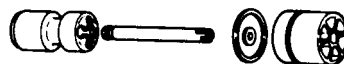

60090-HF



60400

FLECK VALVE PART ASSEMBLIES & SERVICE EQUIPMENT

BYPASS VALVES AND YOKES

| FIG. NO. | PART # | DESCRIPTION | PRICE |
|----------|--------|---------------|-------|
| 36464 | 60040 | Model 5600 | |
| 42632 | 60041 | Model 5600 1" | |

BRINE VALVES AND COMPONENTS

| FIG. NO. | PART # | DESCRIPTION | PRICE |
|----------|-----------|-------------------------------------|-------|
| 45490 | 60026 | Float & grommets | |
| 45506 | 60025-FFA | Model 400A body only | |
| 44760 | 60029 | Model 1600 short stem 2500/2700 | |
| 45513 | 60031 | Model 3600 (NO BLFC) | |
| 45514 | 60032 | Model 4600 & 5600 | |
| 42630 | 60034 | Model 2900 brine valve | |
| 45515 | 60033 | Model 3100 | |
| 42631 | 60350 | Model 9000 | |
| 38957 | 60027-FFA | 2300 safety valve assembly wo/float | |

SERVICE EQUIPMENT

| FIG. NO. | PART # | DESCRIPTION | PRICE |
|----------|--------|----------------------------|-------|
| 45491 | 16516 | Stuffer 2850/3100 | |
| 36268 | 11098 | Stuffer 2500/2750 | |
| 36269 | 13061 | Puller 2500/2750 | |
| 36464 | 60040 | Model 5600-brass 3/4" NPT | |
| 45641 | 13759 | Tool fir 5600 D.L.F.C. | |
| 45647 | 60460 | Meter checker - std. range | |
| 45648 | 60461 | Meter checker - ext. range | |

INJECTOR ASSEMBLY (PLASTIC) COMPLETE

| FIG. NO. | PART # | DESCRIPTION | PRICE |
|----------|--------|--------------------------|-------|
| 38960 | 60080 | Model 1500, 2500 & 2700 | |
| 42654 | 60084 | Model 4600/5600 | |
| 45567 | 60384 | Model 5600 filter module | |
| 42655 | 60385 | Model 9000 time fill | |

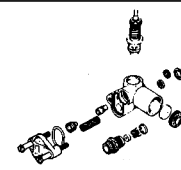

| SIZE | COLOR | NOZZLE FIG. NO. | NOZZLE | PRICE | THROAT FIG. NO. | THROAT | PRICE |
|-------|--------|-----------------|----------|-------|-----------------|----------|-------|
| 0 | Red | 41932 | 10913-R | | 41935 | 10914-R | |
| 1 | White | 41933 | 10913-W | | 41936 | 10914-W | |
| 2 | Blue | 41934 | 10913-BL | | 41937 | 10914-BL | |
| 3 | Yellow | 50807 | 10913-Y | | 50809 | 10914-Y | |
| 4 | Green | 50808 | 10913-G | | 50810 | 10914-G | |
| KMnO4 | Gray | 46156 | 12973 | | 46157 | 12974 | |

SVO VALVE ASSEMBLY

| FIG. NO. | PART # | DESCRIPTION | PRICE |
|----------|------------|------------------------------------|-------|
| 45608 | 60150-1600 | Model 15/25/2700 SVO VLV assy 1600 | |
| 45609 | 60150-3100 | Model 2750, 2850, 2900 | |
| 45204 | 60150-3150 | 3100 Model 3150, 3900 | |

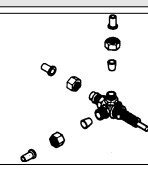

FLECK VALVE PART ASSEMBLIES & SERVICE EQUIPMENT

AIR CHECKS

| FIG. NO. | PART # | DESCRIPTION | PRICE |
|----------|--------|----------------------------|-------|
| 42625 | 60002 | #500 Residential Air Check | |
| 42626 | 60003 | #500 CPVC Hot | |

TIMER

| FIG. NO. | PART # | DESCRIPTION | PRICE |
|----------|----------|---|-------|
| 45659 | 60303-13 | 3200 7 day timer w/STF - 120/60 | |
| 45660 | 60304-13 | 3200 12 day timer w/STF - 120/60 | |
| 51656 | 60305-13 | 3200 demand timer w/STF - 120/60 | |
| 51383 | 60306-13 | 3210 delay meter timer w/STF - 120/60 | |
| 45661 | 60375 | 9000 timer 1/15 RPM (3/4" vlv) (1 minP/N) | |
| 45662 | 60376 | 9000 timer 1/30 RPM (1" vlv) (2 min (P/N) | |

DRIVE MOTOR ASSEMBLY WITH SWITCHES

| FIG. NO. | PART # | DESCRIPTION | PRICE |
|----------|----------|------------------------|-------|
| 42642 | 60555-51 | Model 2900 lower drive | |

SEAL KITS

| FIG. NO. | PART # | DESCRIPTION | PRICE |
|----------|--------|----------------------------------|-------|
| 38964 | 60121 | Model 15/25/2700 seal kit | |
| 36267 | 60122 | Model 25/2700 hot water seal kit | |
| 45592 | 60124 | Model 3600 hot water seal kit | |
| 44761 | 60129 | Model 2850 | |
| 45591 | 60123 | Model 3600, 4000 & 4600 seal kit | |
| 42679 | 60125 | Model 5600 & 9000 seal kit | |
| 38964 | 60121 | Model 2500/2700/2750 seal kit | |
| 42680 | 60128 | Model 2900 lower seal kit | |
| 42681 | 60421 | Model 9000 lower seal kit | |
| 45593 | 60126 | Model 3100 seal assembly | |
| 45594 | 60131 | Model 3150 seal assembly | |

FEEDER PRESSURE RELIEF VALVE

| FIG. NO. | PART # | DESCRIPTION | PRICE |
|----------|--------|---------------------------|-------|
| 45534 | 60065 | Model 2500 & 3600 filters | |

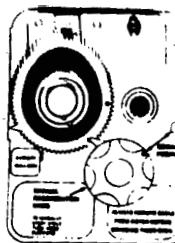

**9000 SERIES
TIMER**



BRINE TANK DATA

GENERAL DATA

The complete brine system is probably one of the most important aspects of domestic and commercial fully automatic water softeners. This section contains facts, and data on all the components necessary to make a complete domestic or commercial brine system. Individual components and combinations of these components are, of course, adaptable for use in varied systems. In view of the problems normally inherent in brine systems, our purpose at this point is to furnish a proven design with data and tables on completed brine systems for fully automatic water softeners.

Our suggested brine system has been carefully thought out, designed and given extensive field tests. Please note that it is made up almost entirely of non-metallic materials and incorporates a salt grid system.

The seamless pure polyethylene salt storage tank is blow molded, eliminating structural faults and the possibility of brine seepage. Contrary to a tapered brine tank, the straight sides of this tank will allow the salt level to lower uniformly as the salt dissolves with each regeneration. This and the low water level prevent bridging of the salt.

The grid system permits use of 100% soluble pellet type salt. 1/2" water contact with salt produces fully saturated brine.

The overflow assembly is located close

to the brine level to minimize loss of salt in the event of malfunction. The overflow also prevents a skum from being formed in the tightly capped brine well.

The brine valve is protected by a grid plate, a brine well and brine well cover. Thus, salt cannot accidentally be poured in to the brine well, nor can other foreign material reach the brine solution.

To insure fully saturated brine in the brine well, a circulation hole is located in the well immediately under the grid plate.

1/4" heavy wall rigid #300 PVC is recommended for the brine pipe. This noncorrosive pipe and the brine valve can be assembled by threading the brine pipe into the valve using Teflon tape to prevent the possibility of leakage.

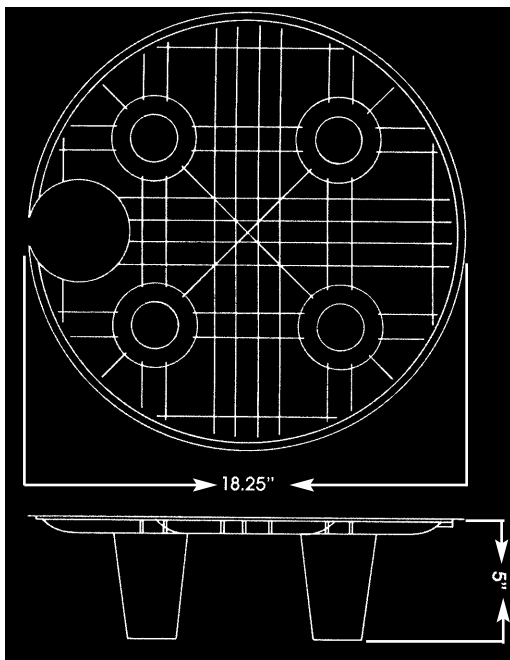

PLASTIC GRID

Economical, convenient, one piece salt grids with exceptional strength and durability for years of trouble free service.

ECONOMICAL - Patented one piece construction eliminates assembly time required with old style grids. Nestable, light weight design substantially reduces shipping.

DURABLE - Rugged modeled polyethylene will not transmit taste, color, or odor. Ribbed design provides maximum strength.

CONVENIENT - Nestable design and leg extensions reduce warehouse space and inventory. One piece design eliminates lost and mis-placed parts. Available with holes for 4" or 3 1/2" brine wells and blank for custom fabrication.

| FIG. NO. | DESCRIPTION | UNIT CTN | CTN. WT. | PRICE |
|----------|---|----------|----------|-------|
| 39002 | Plastic Grid - 4" Brine Well Hole 18" | 25 | 37 | |
| 50965 | Plastic Grid - 3 1/2" Brine Well Hole 18" | 25 | 37 | |
| | 3" Leg Extension Set (4 per set) | 25 | 10 | |
| 44622 | 6" Leg Extension Set (4 per set) | 25 | 16 | |

*Grid available with fine mesh screen for solar salt applications. Please consult us for specifications.

BRINE TANKS WITH COVER

| FIG. NO. | DESCRIPTION | DIA X HEIGHT | SALT | GALLONS | UNIT CTN WGT |
|-----------------------------------|--------------------|--------------|------|---------|--------------|
| RESIDENTIAL (Polyethylene) | | | | | |
| 68332 | Blue Square | 11"x11"x38" | 156 | 19 | 1/15 |
| | Black Square | 11"x11"x38" | | | |
| 42779 | Natural Square | 11"x11"x38" | | | |
| 50376 | Blue Square | 15"x17" | 275 | 33 | |
| 39024 | Natural Square | 15"x17" | | | |
| 50376 | Blue Square | 15"x17" | | | |
| 47145 | Blue Round | 18"x33" | 375 | 35 | |
| 39019 | Almond Round | 18"x33" | | | |
| 47146 | Black Round | 18"x33" | | | |
| 52154 | Natural Round | 18"x33" | | 35 | |
| 47147 | White Round | 18"x33" | | | |
| 49233 | Blue Round | 18"x40" | | | |
| 40897 | Almond Round | 18"x40" | 450 | 43 | |
| 47148 | Black Round | 18"x40" | | | |
| 47773 | Fiberglass Cabinet | 13.5"x35" | 250 | | |

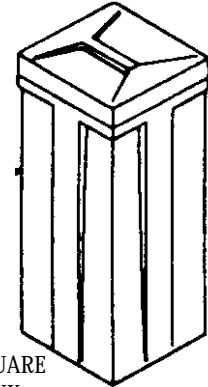

SQUARE TANK

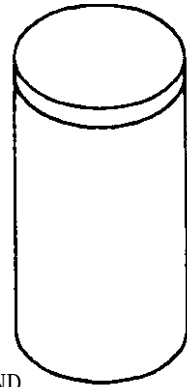

ROUND TANK

| | | | | | |
|----------------------------------|--------------------------|---------|------|-----|-------|
| COMMERCIAL (Polyethylene) | | | | | |
| 40734 | Poly Black | 24"x41" | 650 | 81 | 1/26 |
| 40736 | Poly Black | 24"x50" | 800 | 100 | 1/29 |
| | ROTATIONAL MOLDED | | | | |
| 40735 | Poly Black | 24"x48" | 760 | 95 | 1/40 |
| 41141 | Poly Black | 30"x48" | 1200 | 145 | 1/55 |
| 41142 | Poly Black | 39"x48" | 2000 | 250 | 1/70 |
| 47792 | Poly Black | 42"x60" | 2850 | 355 | 1/80 |
| 47793 | Poly Black | 50"x60" | 4080 | 500 | 1/130 |

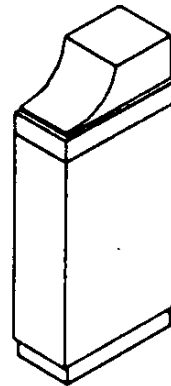

CABINET TANK

| | | | | | |
|---|------------|---------|------|------|-------|
| COMMERCIAL-INDUSTRIAL (Fiberglass) | | | | | |
| | Fiberglass | 48"x48" | 3000 | 370 | 1/140 |
| | Fiberglass | 60"x60" | 5800 | 730 | 1/220 |
| | Fiberglass | 60"x72" | 9000 | 810 | 1/272 |
| | Fiberglass | 72"x60" | 9500 | 1200 | 1/380 |

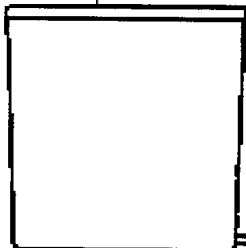

COMMERCIAL BRINE TANK

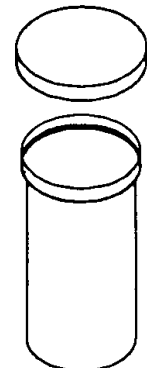

POLY TANK

18" DIAMETER BRINE TANK ASSEMBLY

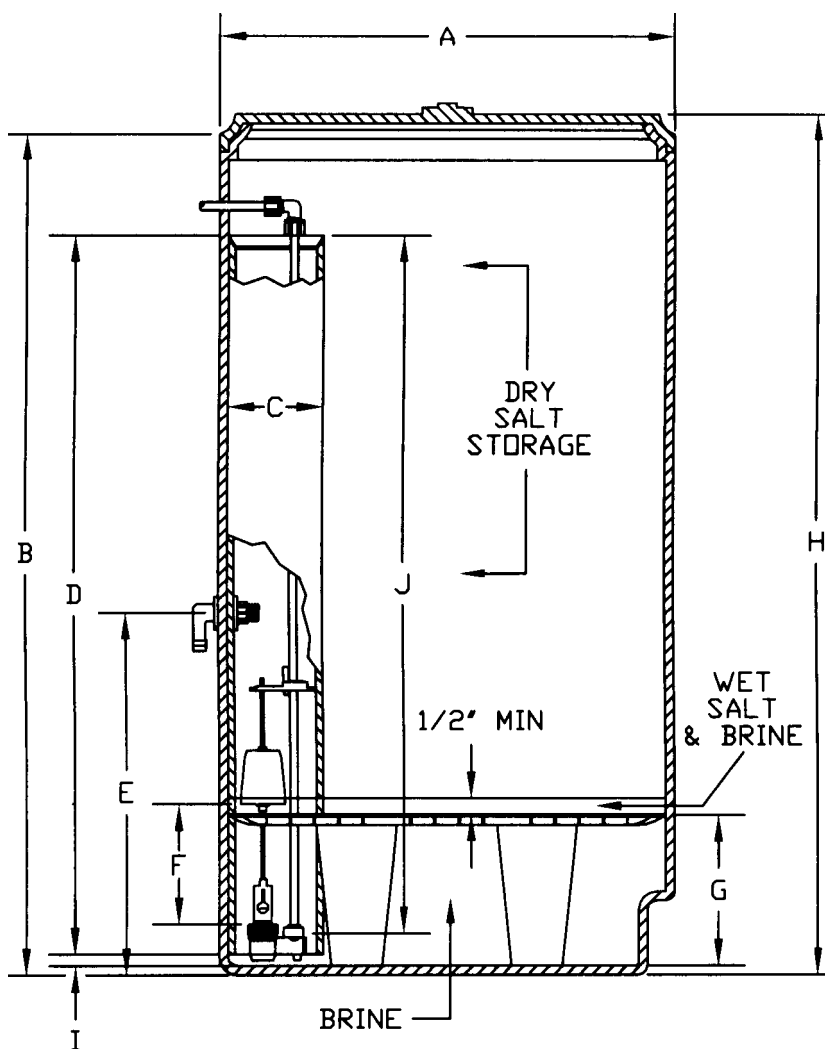

Tank Dimensions in Inches

- A - 18 1/2" diameter
- B - tank height (33" or 40"), see table
- C - 3 1/2" or 4" diameter
- D - brine well length, see notes above
- E - to customer specification
- F - float setting
- G - grid height, see table
- H - 33 1/4" or 40 1/4"
- I - 1"
- J - brine pipe length, see table

Table for TP500 Plastic Grid Set (G = 5")

| Pounds of Salt | Gallons of Brine | Float Setting | Brine Pipe Length * | |
|----------------|------------------|---------------|---------------------|----------|
| | | | 33" Tank | 40" Tank |
| 4 | 1.5 | 2 3/4 | 26 1/2 | 34 1/2 |
| 5 | 1.9 | 3 1/4 | 27 | 35 |
| 6 | 2.3 | 3 1/2 | 27 1/4 | 35 1/4 |
| 7 | 2.6 | 3 3/4 | 27 1/2 | 35 1/2 |
| 8 | 3 | 4 1/4 | 27 3/4 | 35 3/4 |
| 9 | 3.4 | 4 3/4 | 27 3/4 | 35 3/4 |
| 10 | 3.8 | 5 1/4 | 27 3/4 | 35 3/4 |

*Brine pipe length is based on 28" brine well in 33" tank and 36" brine well in a 40" tank. Brine pipe length (J) includes threaded portion of pipe if fittings are used.

Float setting (F) is based on distance between the top of the brine valve body nut and the bottom of the float with the valve in the closed (float up) position. All dimensions to the nearest 1/4 inch.

Table for TP500 Plastic Grid with 3" Leg Extensions (G = 8")

| Pounds of Salt | Gallons of Brine | Float Setting | Brine Pipe Length | |
|----------------|------------------|---------------|-------------------|----------|
| | | | 33" Tank | 40" Tank |
| 6 | 2.3 | 3 1/2 | 24 1/4 | 32 1/4 |
| 7 | 2.6 | 3 3/4 | 24 1/2 | 32 1/2 |
| 8 | 3 | 4 | 24 3/4 | 32 3/4 |
| 9 | 3.4 | 4 1/4 | 25 | 33 |
| 10 | 3.9 | 4 3/4 | 25 1/2 | 33 1/2 |
| 11 | 4.2 | 5 | 25 3/4 | 33 3/4 |
| 12 | 4.6 | 5 1/4 | 26 | 34 |
| 13 | 4.9 | 5 1/2 | 26 1/4 | 34 1/4 |
| 14 | 5.2 | 6 | 26 3/4 | 34 3/4 |
| 15 | 5.8 | 6 1/4 | 27 | 35 |
| 16 | 6.1 | 6 1/2 | 27 1/4 | 35 1/4 |
| 17 | 6.4 | 6 3/4 | 27 1/2 | 35 1/2 |
| 18 | 6.8 | 7 1/4 | 27 3/4 | 35 3/4 |
| 19 | 7.2 | 7 3/4 | 27 3/4 | 35 3/4 |
| 20 | 7.6 | 8 1/2 | 27 3/4 | 35 3/4 |

Table for TP500 Plastic Grid with 6" Leg Extensions (G = 11")

| Pounds of Salt | Gallons of Brine | Float Setting | Brine Pipe Length * | |
|----------------|------------------|---------------|---------------------|----------|
| | | | 33" Tank | 40" Tank |
| 12 | 4.6 | 5 1/4 | 23 | 31 |
| 13 | 4.9 | 5 1/2 | 23 1/2 | 31 1/4 |
| 14 | 5.2 | 6 | 23 3/4 | 31 3/4 |
| 15 | 5.8 | 6 1/4 | 24 | 32 |
| 16 | 6.1 | 6 1/2 | 24 1/4 | 32 1/4 |
| 17 | 6.4 | 6 3/4 | 24 1/2 | 32 1/2 |
| 18 | 6.8 | 7 | 24 3/4 | 32 3/4 |
| 19 | 7.2 | 7 1/4 | 25 | 33 |
| 20 | 7.6 | 7 3/4 | 25 1/2 | 33 1/2 |
| 21 | 7.9 | 8 | 25 3/4 | 33 3/4 |
| 22 | 8.3 | 8 1/4 | 26 | 34 |
| 23 | 8.7 | 8 1/2 | 26 1/4 | 34 1/4 |
| 24 | 9.1 | 9 | 26 3/4 | 34 3/4 |
| 25 | 9.4 | 9 1/4 | 27 | 35 |
| 26 | 9.8 | 9 1/2 | 27 1/4 | 35 |
| 27 | 10.2 | 9 3/4 | 27 1/2 | 35 1/2 |
| 28 | 10.6 | 10 1/4 | 27 3/4 | 35 3/4 |
| 29 | 10.9 | 10 3/4 | 27 3/4 | 35 3/4 |
| 30 | 11.3 | 11 1/2 | 27 3/4 | 35 3/4 |

POLYGLASS TANK

STRUCTURAL
NORTH AMERICA

Tank Volume Selector Guide

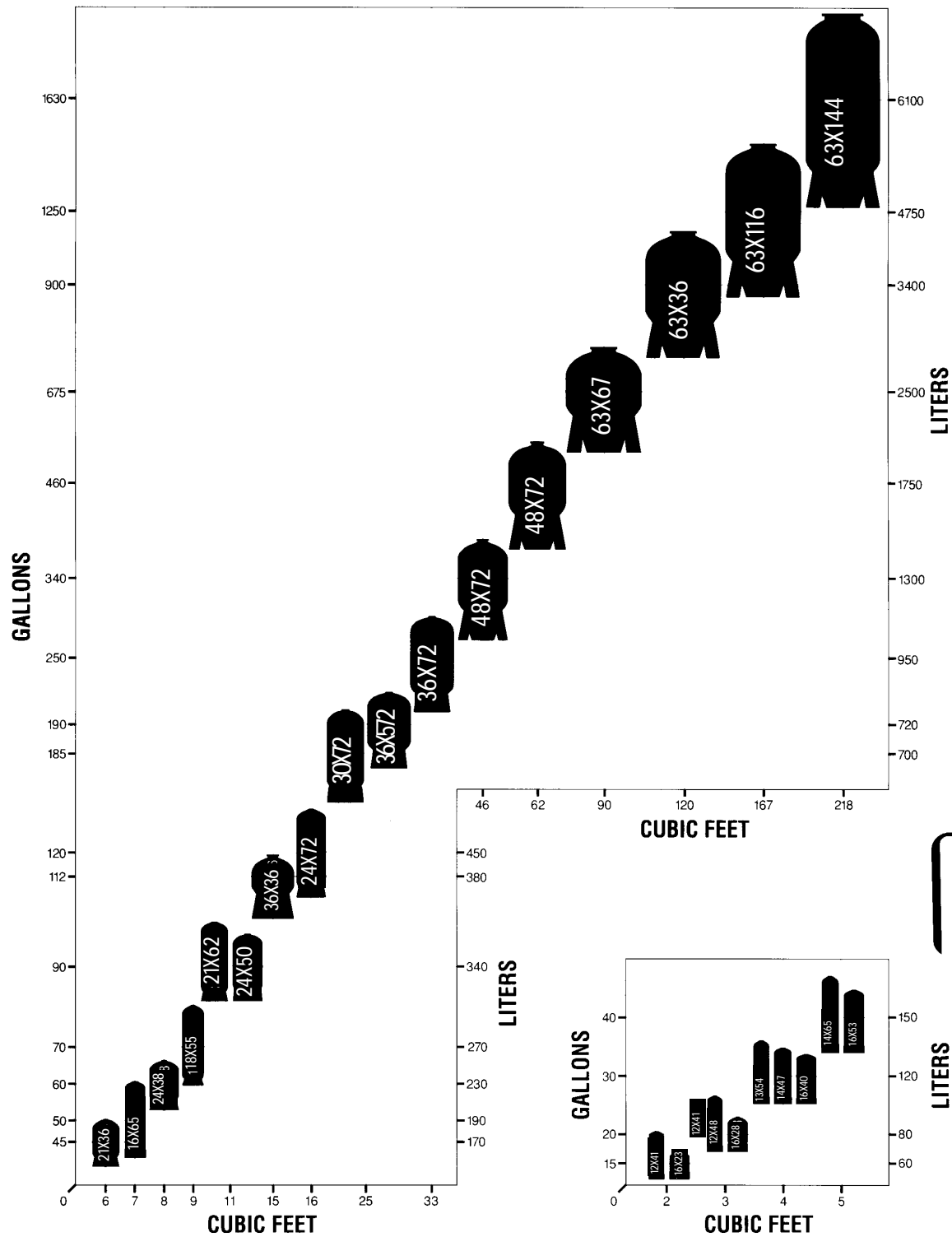

POLY GLASS TANKS

Standard top opening is 2 1/2" for all tanks through 13" diameter. All tanks available with top openings of 2 1/2", 4", 4 1/2" and 6".

Certain tanks are available with flanged opening top, bottom or both.

| FIG. NO. | SIZE | PRICE | FIG. NO. | SIZE | PRICE |
|----------|--------|-------|----------|--------|-------|
| 64320 | 6X12 | | 51191 | 12X48 | |
| 72272 | 6X13 | | 50426 | 12X52 | |
| 42943 | 6X18 | | 48983 | 13X54 | |
| 51168 | 6X35 | | 51318 | 14X47* | |
| 58660 | 7X24 | | 60708 | 14X50 | |
| 50424 | 7X35 | | 50427 | 14X65* | |
| 59400 | 7X40 | | 68972 | 16X40 | |
| 38726 | 7X44 | | 50428 | 16X65 | |
| 44365 | 8X18 | | 47093 | 18X65 | |
| 58478 | 8X24 | | 42600 | 20X62 | |
| 44666 | 8X30 | | 49659 | 21X36 | |
| 39008 | 8X35 | | 69510 | 21X38 | |
| 52586 | 8X40 | | 51474 | 21X62 | |
| 38727 | 8X44* | | 44155 | 22X44 | |
| 47092 | 9X24 | | 45466 | 22X54 | |
| 51784 | 9X35 | | 42944 | 22X60 | |
| 62807 | 9X40 | | 49660 | 24X38 | |
| 42602 | 9X42* | | 54858 | 24X50 | |
| 48812 | 9X48* | | 42601 | 24X60 | |
| 39010 | 10X35 | | 42948 | 24X71 | |
| 32293 | 10X40 | | 49387 | 24X72 | |
| 38729 | 10X44 | | 50430 | 30X72 | |
| 50425 | 10X47 | | 64306 | 36X57 | |
| 32294 | 10X54 | | 50823 | 36X72 | |
| 47876 | 12X36* | | 50432 | 42X72 | |
| 37961 | 12X42* | | 55810 | 48X72 | |
| | | | 75807 | 63x67 | |

*Tanks are stocked with rubber bases and suitable for DI water.

POLYESTER FIBERGLASS TANKS

Most tanks available with dome holes.

Standard top opening is 2 1/2" for all tanks through 13" diameter. All tanks available with top openings of 2 1/2", 4", 4 1/2" and 6".

Many tanks available with side holes.

| FIG. NO. | SIZE | PRICE | FIG. NO. | SIZE | PRICE |
|----------|--------|-------|----------|--------|-------|
| 47097 | 8x40 | | 32292 | 13x54 | |
| 52150 | 10x19* | | 44148 | 14x65 | |
| 32288 | 10x30 | | 44152 | 16x23 | |
| 39016 | 10x35 | | 44150 | 16x33 | |
| 32289 | 10x40* | | 44147 | 16x65* | |
| 38733 | 10x44 | | 47611 | 21x62 | |
| 39006 | 10x47 | | 50067 | 24x38 | |
| 32290 | 10x54* | | 47612 | 24x71 | |
| 48824 | 12x29 | | 45393 | 30x72 | |
| 32291 | 12x48 | | 50066 | 36x72 | |

*Tanks available for hot water up to 150°F

STAINLESS STEEL TANKS FOR HIGHER TEMPERATURE APPLICATIONS TO 200°F

| | | | |
|-------|------|-------|-------|
| 63521 | 8x18 | 67566 | 12x48 |
|-------|------|-------|-------|

For additional information call: 610-275-4453 or Fax: 610-279-6299

Please call for current prices.

SELECTING MINERAL TANK JACKETS

MINERAL TANK JACKETS FIT 7", 8", 9" and 10" OD mineral tanks.

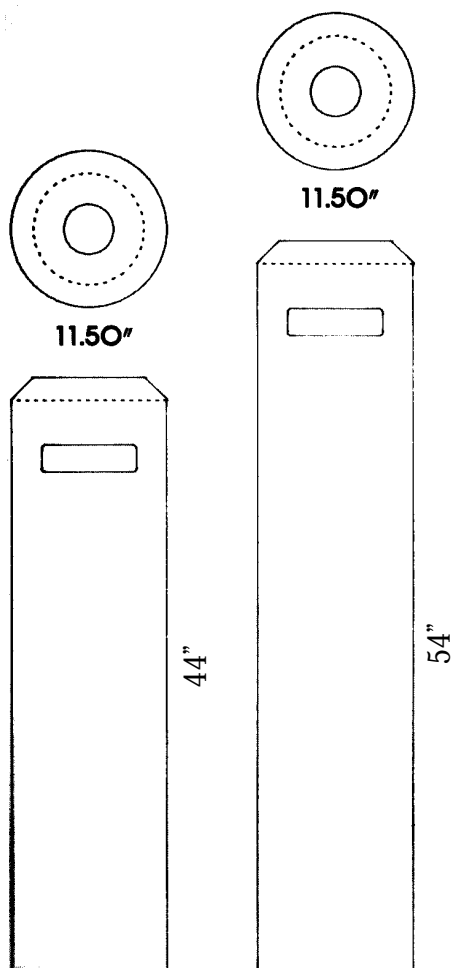

| FIG. NO. | DESCRIPTION | PRICE |
|----------|------------------------------|-------|
| 44614 | Almond 11 1/2" OD x 44" long | |
| 48774 | Almond 11 1/2" OD x 54" long | |

FOR PRIVATE LABEL MOLD INSERTS
AND CUSTOM COLORS, PLEASE
CONSULT YOUR DUFF COMPANY
WATER TREATMENT EXPERT 610-
275-4453

SELECTING TANK JACKETS

MINERAL TANKS being used for softeners or filters are available in 2 styles.

POLYGLASS - inner shell constructed of polyethylene, externally wound with continuous fiberglass, roping to provide superior strength under pressures to 150 psi and 120°F temperature.

POLYESTER FIBERGLASS REINFORCED PLASTIC (FRP) - a seamless one piece molded vessel with no welds or joints. Designed for 150 psi and 120°F temp (vinylester FRP good for 150 psi and 150°F Temp). Size ranges are 6" diameter to 16" diameter.

POLYGLASS tanks are available from Structural Fibers North America, Park Industrial and Water Tech Division of Water Mark Group. Tank opening are available in top, bottom or side configurations.

POLYESTER AND VINYLESTER tanks are available from Structural Fibers North America.

**FOR MORE SPECIFIC INFORMATION, CONTACT DUFF COMPANY WATER TREATMENT DEPARTMENT
AT 610-275-4453 FOR MORE DETAILED MINERAL TANK CATALOG**

PUROLITE® ION EXCHANGE RESINS CATION EXCHANGERS

| PUROLITE | TYPE | IONIC FORM | TOTAL VOLUME CAP MIN eq/l | SHIPPING WEIGHT APPRX lbs/cu ft | WATER RETENTION % | REMARKS |
|----------|--------------------------------|------------|------------------------------|------------------------------------|-------------------|--|
| C-100 | Strong Acid Polystyrene | Na | 2.0 | 52 | 44-48 | Gel type standard resin with high capacity for softening and demineralization. |
| C-100E | Strong Acid Polystyrene | Na | 1.9 | 52 | 46-50 | Gel type, particularly for softening. Resin specially treated for domestic use and for industrial use where potable water is required. |
| C100X10 | Strong Acid Polystyrene | Na | 2.2 | 54 | 40-44 | Gel type with excellent resistance to oxidation. Give particularly good separation from anion resin in mixed beds. |
| C-147 | Strong Acid Polystyrene | Na | 1.8 | 50 | 55-60 | Macroporous type with good resistance to attrition and osmotic shock. Excellent kinetics of exchange. |
| C-150 | Strong Acid Polystyrene | Na | 1.8 | 50 | 48-53 | Macroporous type with excellent resistance to attrition and osmotic shock. For treatment of condensate, continuous processes and special applications (galvanic plating, sugar...) |
| C-155 | Strong Acid Polystyrene | Na | 2.2 | 50 | 39-44 | Macroporous type. More highly cross linked. For special applications. |
| C-160 | Strong Acid Polystyrene | Na | 2.4 | 52 | 35-40 | Macroporous type. Very highly crosslinked. High capacity. For special applications (Quentin process, treatment of industrial waste. Offers excellent resistance to oxidation). |
| C-105 | Weak Acid Poly Metha-Acrylic | H | 4.2 | 47 | 43-48 | Gel type. High capacity. Removal of temporary hardness and alkalinity. |
| C-106 | Weak Acid Poly Metha-Acrylic | H | 2.7 | 46 | 52-58 | Macroporous type with excellent resistance to osmotic shock. For special applications. Treatment of ammoniacal condensates, fixation of antibiotics. |
| C-115 | Weak Acid Poly Metha-AcrylicNa | H | 3.5 | 46 | 46-53 | Very weak acidic type for special applications. (Pharmaceutical, fixation of antibiotics. |

PUROLITE® WEAK BASE ANION EXCHANGERS

| PUROLITE | TYPE | IONIC FORM | TOTAL VOL. CAP EQ/L | SHP WGHT APPRX LBS/CU FT | WATER RETENTION % | REMARKS AND PRINCIPAL APPLICATIONS |
|----------|-------------|------------|---------------------|--------------------------|-------------------|--|
| A100 | Polystyrene | Freebase | 1.3 | 41 | 53-60 | Macroporous type. Good osmotic resistance. Resin optimized for demineralization of water and sucrose. |
| A103 | Polystyrene | Freebase | 1.6 | 41 | 48-55 | Macroporous type. High capacity for demineralization of glucose and other organic solutions. |
| A104 | Polystyrene | Freebase | 1.8 | 41 | 47-54 | Macroporous type. Particularly high capacity for demineralization and decolorization of organic solutions including glucose, fructose... |
| A830 | Polyacrylic | Freebase | 2.7 | 44 | 47-53 | Special applications. Sulfate removal from sea water. Effluent neutralization. |
| A845 | Polyacrylic | Freebase | 42 | 42 | 56-62 | Demineralization of water high in organic matter and of organic solutions (sugar juices, gelatin...) |

READY TO USE PUROLITE® MIXED BEDS

| PUROLITE | APPEARANCE | PUROLITE COMPONENT RESINS | COMPONENT TYPE AND % | IONIC FORMS | SHIP WGHT APPRX lbs/cu ft | USEFUL CAPACITY eq/l | APPLICATIONS |
|------------|--|---------------------------|--|-----------------|---------------------------|--|---|
| NRW 37 | Without indicator | C100 (H) | 40% strong acid cation | 99% H | 43 | Min. 0.55 (for end point of 10 micromho) | Production of demineralized water of high purity. Excellent silica removal. Conductivity attainable less than 0.1 micromho. |
| NR2 37 IND | With indicator Blue(regenerated) Amber(exhausted) | A400 (OH) | 60% strong base anion Gel Type I | 95% OH | | | |
| NRW 37 SC | Without indicator | C100 (H) A400(OH) | 40% strong acid cation 60% strong base anion Gel Type | 99% H 95% OH | 43 | Minimum 0.55 (for end point of 10 micromho) | Similar to those for NRW37 plus extremely low levels of Total Organic Carbon (TOC) in effluent water. |
| EX MB | Without indicator (maximum color differential on separation) | C100X10 (H) A400(OH) | 40% strong acid cation 60% strong base anion Gel Type I | 99% H 95% OH | 45 | Minimum 0.54 (for end point of 10 micromho) | Similar to those for NRW37SC and with excellent separation ability for efficient regeneration. |
| NRW 38 | Without indicator | C100 (H) A300 (OH) | 40% strong acid cation 60% strong base anion Gel Type II | 99% H 95% OH | 43 | Minimum 0.6 (for end point of 10 micromho) | Production of demineralized water of high purity at more capacity using a type II strong base anion. |

PUROLITE® ION EXCHANGE RESINS STRONG BASE ANION EXCHANGERS

| PUROLITE | TYPE | IONIC FORM | TOTAL VOLUME CAP MIN eq/l | SHIPPING WEIGHT APPRX lbs/cu ft | WATER RETENTION % | REMARKS |
|----------|------------------------|------------|------------------------------|------------------------------------|-------------------|--|
| A-400 | Polystyrene Type I | Cl | 1.3 | 43 | 45-54 | Clear gel porous type. High operating capacity. Good kinetics giving demineralization to high purity. Good silica removal. |
| A-600 | Polystyrene Type I | Cl | 1.4 | 44 | 43-48 | Clear gel type. Good mechanical strength. Production of ultra pure water. Good silica removal. |
| A-444 | Polystyrene Type I | Cl | 1.1 | 42 | 50-60 | Highly porous for operating with waters high in organics. |
| A-300 | Polystyrene Type I | Cl | 1.4 | 44 | 40-45 | Clear gel type. High capacity for demineralization of water. |
| A-500 | Polystyrene Type I | Cl | 1.15 | 43 | 53-58 | Macroporous type. Very good mechanical and osmotic resistance. For condensate treatment and continuous systems. Good silica removal. |
| A-500P | Polystyrene Type I | Cl | 0.8 | 42 | 63-70 | Macroporous type. Highly porous. For removal of organic matter. Decolorization of sugar solutions. |
| A-501P | Polystyrene Type I | Cl | 0.6 | 38 | 70-75 | Adsorption of colloidal silica and hydrous metal oxides, iron and organics. |
| A-510 | Polystyrene Type II | Cl | 1.2 | 43 | 44-51 | Macroporous type. High operating capacity. Excellent mechanical and osmotic resistance. For demineralization, fluidized beds and continuous systems. |
| A-850 | Poly-Acrylic | Cl | 1.25 | 45 | 57-62 | Clear gel type. Good mechanical resistance. Reversibly removes organics with good resistance to fouling. For demineralization of water and sugar decolorization. |
| A-860 | Poly-Acrylic | Cl | 0.8 | 44 | 66-72 | Macroporous type. Adsorbent resin for decolorisation of organic solutions (sugar syrups). |
| A-870 | Poly-Acrylic | Cl Fb | 1.35 | 44 | 57-62 | Excellent organics removal with extremely high operating capacity, removes both strong and weak acids. |

PUROLITE® GRADES PARTICLE SIZE: ANION RESINS

| PUROLITE GRADE | UNIFORMITY COEFFICIENT MAXIMUM | EFFECTIVE SIZE, mm TYPICAL | SIZE RANGE LIMITATION, mm & US mesh | | | | | | | | PRINCIPAL APPLICATIONS | | |
|----------------|--------------------------------|----------------------------|-------------------------------------|------|------|------|------|------|------|------|------------------------|------|---|
| | | | <0.3 | <.42 | <0.5 | <.63 | <.71 | <.63 | <.85 | <1.0 | | <1.2 | |
| | | | 50 | 40 | 35 | 30 | 25 | 30 | 20 | 18 | | 16 | |
| TD | 1.70 | 0.50 | 1% | | | | | | | | | 5% | Standard Quality |
| MB | 1.70 | 0.50 | 1% | | | | | | | | | 2% | Mixed beds (MIXLITE) |
| PL | 1.45 | 0.55 | | 2% | | | | | | | | 5% | Condensate polishing (POLILITE). |
| TL | 1.35 | 0.80 | | 1% | | | 1% | | 5% | | | | Three component mixed bed (TRILITE) |
| CL | 1.35 | 0.55 | | 1% | | | | | 5% | | | | Continuous processes (CONTILITE) |
| FL | 1.55 | 0.55 | | 2% | | | | | | | | 10% | Floating beds, counter-flow operation (FLUDITE). |
| DL strong | 1.35 | 0.60 | | | | 5% | | | | | | 25% | Layered beds, lower layer (DOUBLITE) |
| DL weak | 1.35 | 0.40 | 3% | | | | | 5% | | | | | Layered beds, upper layer (DOUBLEITE) |
| S | 1.50 | 0.55 | | 2% | | | | | | | | 2% | Special applications (demineralization of sugar...) |
| C | 1.50 | 0.55 | | 2% | | | | | | | | 2% | High flow rate applications |
| G | 1.50 | 0.63 | | | 2% | | | | | | | 10% | Ultra low pressure loss |
| PUROFINE | 1.2 | 0.45 | | 1% | | | 1% | | | | | | High efficiency demineralization. Good kinetics, good regeneration efficiency |

PUROLITE® GRADES PARTICLE SIZE: CATION RESINS

| PUROLITE GRADE | UNIFORMITY COEFFICIENT MAXIMUM | EFFECTIVE SIZE, mm TYPICAL | SIZE RANGE LIMITATION, mm & US mesh | | | | | | | | PRINCIPAL APPLICATIONS | | |
|----------------|--------------------------------|----------------------------|-------------------------------------|------|------|------|------|------|------|------|------------------------|------|---|
| | | | <0.3 | <.42 | <0.5 | <.63 | <.71 | <.63 | <.85 | <1.0 | | <1.2 | |
| | | | 50 | 40 | 35 | 30 | 25 | 30 | 20 | 18 | | 16 | |
| STD | 1.70 | 0.50 | 1% | | | | | | | | | 5% | Standard Quality |
| MB | 1.70 | 0.50 | 1% | | | | | | | | | 5% | Mixed beds (MIXLITE) |
| PL | 1.45 | | | 2% | | | | | | | | 5% | Condensate polishing (POLILITE). |
| TL | 1.25 | 0.55 | | | | | 1% | | | | | 5% | Three component mixed bed (TRILITE) |
| CL | 1.35 | 0.80 | | 1% | | | | | 5% | | | | Continuous processes (CONTILITE) |
| FL | 1.55 | 0.55 | | 2% | | | | | | | | 10% | Floating beds (FLUDITE). |
| DL strong | 1.35 | 0.60 | | | | 5% | | | | | | 15% | Layered beds, lower layer (DOUBLITE) |
| DL weak | 1.35 | 0.40 | 1% | | | | | 5% | | | | | Layered beds, upper layer (DOUBLEITE) |
| S | 1.50 | 0.55 | | 2% | | | | | | | | 2% | Special applications (demineralization of sugar...) |
| C | 1.50 | 0.55 | | 2% | | | | | | | | 2% | High flow rate applications |
| G | 1.50 | 0.63 | | | 2% | | | | | | | 5% | Dishwasher softening at high flow rate |
| PUROFINE | 1.2 | 0.45 | | 1% | | | 1% | | | | | | High efficiency demineralization. Good kinetics, good regeneration efficiency |

**PUROLITE® NUCLEAR GRADE QUALITY
CATION AND ANION EXCHANGERS**

| PUROLITE | TYPE | PUROLITE STD EQUIVA- LENT | IONIC FORM | TOTAL CAPACITY MIN EQ/L | SHIP WGHT APPRX LBS/CU FT | MAX OPER TEMP F | PRINCIPAL APPLICATIONS |
|----------|-------------|------------------------------------|---------------|----------------------------------|------------------------------------|-----------------------|---|
| NRW 100 | Strong Acid | CA00 | H | 1.8 | 50 | 250 | Removal of cations including radioactive isotopes from aqueous solutions. |
| NRW 145 | Strong Acid | C145 | H | 1.4 | 50 | 250 | Filtration of corrosion products in BWR condensate polishers. |
| NRW 150 | Strong Acid | C150 | H | 1.7 | 48 | 250 | Removal of cations including radioactive isotopes. Very good resistance to osmotic shock. |
| NRW 160 | Strong Acid | C160 | H | 2.2 | 49 | 250 | Removal of cations including radioactive isotopes. Highly selective for cesium 137. |
| NRW 300 | Strong Base | A300 | OH | 1.1 | 44 | 105 | High capacity for removal of anions in radioactive streams. |
| NRW 400 | Strong Base | A400 | OH | 1.0 | 42 | 120 | Production of ultra pure water with low TOC for the semiconductor industry. |
| NRW500 | Strong Base | A500 | OH | 1.0 | 42 | 120 | Removal of anions including boric acid, radioactive isotopes and colloids. Very good resistance to osmotic shock. |
| NRW600 | Strong Base | A600 | OH | 1.0 | 42 | 120 | High capacity for removal of anions from radioactive circuits. Good attrition resistance. |

MIXED BEDS

| PUROLITE | PUROLITE STANDARD EQUIVALENT | IONIC FORM | SHIP WGHT APPRX LBS/CU FT | MAX OPER TEMP F | PRINCIPAL APPLICATIONS |
|-----------|------------------------------------|------------|---------------------------------|--------------------|--|
| NRW 37 | CA00/A400 | H / OH | 46 | 140 | Deminerlization and decontamination of secondary cooling circuits/effluent. Excellent resistance to attrition. |
| NRW37 Li7 | C100/A400 | Li7 / OH | 46 | 140 | Decontamination of pressurized water reactor (PWR) circuits. |

NOTE: Nuclear grade mixed beds are normally supplied with near stoichiometric equivalents of anion and cation resin sites. Other ratios are supplied on request.

PURITY OF NUCLEAR GRADE ION EXCHANGERS

1) CATION RESINS

| IONIC FORM | IMPURITIES | LEVEL PPM |
|---------------------------|----------------|--------------|
| H (minimum: 99.9%) | IRON | maximum:50 |
| Li or Li& (minimum : 99%) | HEAVY METALS | maximum:40 |
| | ALKALIS METALS | maximum:40 |

2) ANION RESINS

| IONIC FORM | IMPURITIES | LEVEL PPM |
|--------------------------------|----------------|---------------|
| OH (minimum : 95%) | IRON | maximum : 100 |
| CO ₂ (maximum : 5%) | ALKALIS METALS | maximum : 20 |
| Cl (maximum : 0.2%) | | |

For additional information call: 610-275-4453 or Fax: 610-279-6299
Please call for current prices.

RESINS

| C A T I O N R E S I N | | | | | |
|-----------------------|---------|-------|-------------|---------|-------|
| P U R O L I T E | | | S Y B R O N | | |
| FIG. NO. | DESCR | PRICE | FIG. NO. | DESCR | PRICE |
| 60233 | C100E | | 51446 | C249 | |
| 60235 | C100EB | | 51454 | C266 | |
| 77126 | C100X10 | | 47060 | C253 | |
| 57452 | C100HSC | | 53803 | ION ACC | |
| 75380 | C100EF | | | | |
| 52577 | C106NA | | | | |

| A N I O N R E S I N | | | | | |
|---------------------|--------|-------|-------------|-------|-------|
| P U R O L I T E | | | S Y B R O N | | |
| FIG. NO. | DESCR | PRICE | FIG. NO. | DESCR | PRICE |
| 67665 | A500P | | 38951 | ASB2 | |
| 38952 | A642 | | 38956 | A554 | |
| 47059 | CLA500 | | 68833 | ASB1P | |
| 51455 | A520E | | | | |
| 47026 | A100HP | | | | |
| 51453 | A300C | | | | |
| 57454 | A300 | | | | |
| 57453 | A400HS | | | | |

| M I X E D B E D | | | | | |
|-----------------|---------|-------|-------------|-------|-------|
| P U R O L I T E | | | S Y B R O N | | |
| FIG. NO. | DESCR | PRICE | FIG. NO. | DESCR | PRICE |
| 45382 | NRW37 | | 52286 | MN60 | |
| 57536 | NRW37SC | | | | |

RESINS

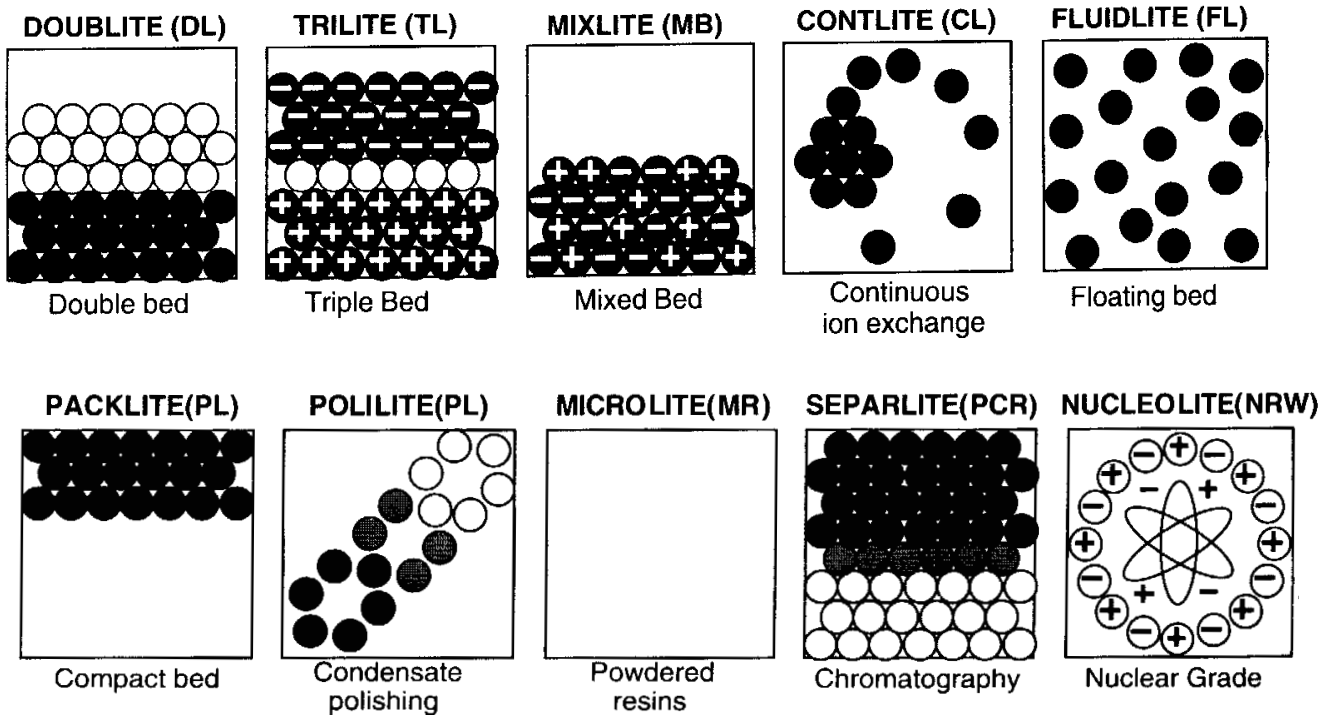

PUROLITE® SPECIAL ION EXCHANGERS

| PUROLITE | TYPE | FUN- TIONAL GROUPS | IONIC FORM | TOTAL CAPACITY MIN EQ/L | SHIP WGHT APPRX LBS/CU FT | WATER REIEN- TION % | REMARKS |
|----------|-------------------|--------------------------|---------------|-------------------------------|------------------------------------|---------------------------|---|
| A520E | Strong Base Anion | Quaternary Ammonium | Cl | 1.0 | 43 | 52-56 | Specifically removes nitrate in water for potable use. |
| A501P | Strong Base Anion | Quaternary Ammonium | Cl | 0.6 | 38 | 70-75 | Specially developed for the absorption of silica and metal based coolids. Can be used for the protection of membranes (RO and ultrafiltration). |
| S920 | Chelating | Thiouronium | H | 1.6 | 45 | 48-54 | Selective removal of metals. Excellent selectivity and capacity for mercury removal. |
| S930 | Chelating | Iminodiacetic | Na | 1.8 | 45 | 45-50 | Selective removal of polyvalent ions (including those of transition metals). |
| S940 | Chelating | Amino-phosphonic | Na | 1.0 | 45 | 60-65 | Highly selective for metals of low atomic weight. Especially useful for decalcification of brine. |
| S950 | Chelating | Amino-phosphonic | Na | 1.3 | 45 | 60-65 | For removal of metals from waste waters. For example in hydrometallurgy and galvanopating industries. |
| A106 | Mixed base | Bi-functional | Free Base Cl | 1.2 | 42 | 45-55 | Deminerlization, affording silica removal from low silica water at good regeneration efficiency |
| A107 | Polystyrene | Primary Amine | Free Base Cl | 1.2 | 42 | 55-60 | Primary amine for special applications. |

SPECIAL PRODUCT RANGES

| SERIES | TYPE | PRINCIPAL APPLICATIONS | REMARKS AND PRINCIPAL APPLICATIONS |
|---|-------------|---|--|
| CHROMATOGRAPH PUROLITE GRADES: PCR | Strong Acid | Narrow size ranges with specific crosslinkaging available in various ionic forms (Na, Ca, K). | Separation of sugars in solution and of biochemical compounds. |
| CHROMATOGRAPHIC PUROLITE GRADES: PCA | Strong Base | Narrow size ranges with specific crosslinking. | Separation and concentration of nuclear waste, ion retardation, hydrometallurgy. |
| CATALYSIS PUROLITE GRADES: CT | Strong Acid | Products with range of porosities and crosslinking | Recommended for a variety of catalytic and pseudocatalytic applications, for example, MTBE production, esterification, alkylation, condensation and polymerization. |
| CATALYSIS PUROLITE GRADES: CTA | Strong Base | Pore volume 0.35 ml/g | Base catalysis of condensation reactions. As active drugs: C100MR, C100Dr (sodium polystyrene sulphonate) A 430 MR (Cholestyramine) As tablet disintegrant: C 115 MR... |
| PHARMACEUTICAL PUROLITE GRADES: MR AND DR RANGES | Various | Specially purified, dry ground (MR) and bead ranges (DR) for medical and veterinary use. | |

For additional information call: 610-275-4453 or Fax: 610-279-6299
Please call for current prices.

CLOSEST COMPETITIVE EQUIVALENTS

ANION EXCHANGE RESINS

| <u>PUROLITE</u> | <u>ROHM & HAAS</u> | <u>DOW</u> | <u>IONAC</u> | <u>DUOLITE</u> |
|-----------------|------------------------|--------------|--------------|----------------|
| A-600 | IRA-400 | SBR | ASB-1 | A-109 |
| A-400IRA-402 | SBR-P | ASB-1P/A-104 | A-101D | |
| A-300/A-300E | IRA-410 | SAR | ASB-2/A-550 | A-102D/A-104 |
| A-850 | IRA-458 | - | - | A-132 |
| A-500 | IRA-900 | MSA-1 | A-641 | A-161 |
| A-510 | IRA-910 | MSA-2 | A-651 | A-162 |
| A-500P | IRA-904 | - | A-642 | - |
| A-100 | IRA-93/94 | MWA-1 | AFP-329 | A-378 |
| A-103 | - | - | - | A-392 |
| A-104 | - | Dowex 66 | - | - |
| A-444 | - | Dowex II | - | - |
| NRW-600 | IRN-78 | SBR | NA-38 | ARA-366 |
| A-845 | IRA-68 | - | - | - |
| A-501P | IRA-938 | - | - | - |
| A-520E | IRA-996 | - | - | - |
| A-870 | IRA-478 | - | - | - |
| A-830 | IRA-35 | - | - | - |
| A-860 | IRA958 | - | - | - |

CATION EXCHANGE RESINS

| <u>PUROLITE</u> | <u>ROHM & HAAS</u> | <u>DOW</u> | <u>IONAC</u> | <u>DUOLITE</u> |
|-----------------|------------------------|--------------|--------------|------------------|
| C-100(Na) | IR- 120 | HCR-S/HCR-W2 | C-249/C-298 | C-20/C-225 |
| C-100H | 120H | - | C-267 | - |
| C-100X10 | IR-122 | HGR/HGR-W2 | C-250/C-299 | C-20X10/C-225X10 |
| C-150 | 200 | MSC-1 | CFP-110 | C-26 |
| C-155 | - | Dowex | - | C-280 |
| C-105 | IRC-76 | CCR-2 | CC | C-433 |
| C-106 | DP-1DP-1 | - | CNN | C-464 |
| C-115 | IRC-50 | - | - | - |
| NRW-100 | IRN-177 | - | NC-10 | - |

MIXED BED RESINS

| <u>PUROLITE</u> | <u>ROHM & HAAS</u> | <u>DOW</u> | <u>IONAC</u> | <u>DUOLITE</u> |
|-----------------|------------------------|------------|--------------|----------------|
| NRW-37 | IRN-150 | MR-3 | NM-60 | ARM-381 |
| EX-MB | - | - | - | - |

UNIFORM BEAD SIZE RESINS

| <u>RESIN TYPE</u> | <u>PUROFINE</u> | <u>ROHM & HAAS</u> | <u>DOW</u> |
|---|-----------------|------------------------|-------------|
| TYPE I GEL ANION | PFA-400 | AMBERJET 4200 | MARATHON A1 |
| TYPE II GEL ANION | PFA-300 | - | MARATHON A2 |
| GEL STRONG ACID CATION | PFC-100 | AMBERJET 1200 | MARATHON C |
| CATION FOR SOFTENERS (STRONG ACID GEL) | C-100EF | - | - |

CLOSEST COMPETITIVE EQUIVALENTS

| PUROLITE | | ROHM & HAAS | | DOW CHEM | | BAYER(WEB) | | MITSUBISHI | |
|----------|-----------|-------------|-------|----------|---------|------------|--------|------------|--|
| PUROLITE | AMBERLITE | DUOLITE | DOWEX | KASTEL | LEWATIT | WOFATIT | RELITE | DIAION | |

Strong Base Anion Resins

| | | | | | | | | |
|--------|-------------|-------|-------|--------|--------|-----------|------|--------|
| A-600 | IRA-400 | A-109 | SBR | A-500 | M-500 | - | - | SA-10A |
| A-400 | IRA-420 | A-113 | SBR-P | - | M-504 | SBW/SW31- | - | SA-12A |
| A-300 | IRA-416 | A-104 | SAR | A-300 | M-600 | SBK | 3-A | SA-20A |
| A-850 | IRA-458 | A-132 | - | - | AP-246 | - | - | - |
| A-500 | IRA-900 | A-161 | MSA-1 | A-500P | MP-500 | SZ-30 | - | PA-312 |
| A-500P | IRA-904 | A-171 | - | - | M-500A | - | 3-AS | PA-308 |
| A-510 | IRA-910 | A-172 | MSA-2 | A-300P | MP-600 | SL-30 | 3-AZ | PA-412 |
| A-520E | IMAC HP 555 | - | - | - | - | - | 2-AS | - |
| A-860 | IRA-958 | A-173 | - | - | - | - | - | - |
| A-870 | IRA-468/478 | - | - | - | - | - | - | - |

Weak Base Anion Resins

| | | | | | | | | |
|-------|-----------|-------|-------|--------|---------|----------|-------|-------|
| A-100 | IRA-94/93 | A-376 | MWA-1 | A-101 | MP-64 | AD-42/41 | A-329 | WA-30 |
| A-103 | - | A-368 | - | - | MP-62 | - | - | WA-21 |
| A-104 | - | - | 66 | - | - | - | - | WA-20 |
| A-105 | - | A-369 | - | A-101S | - | - | - | - |
| A-830 | IRA-60 | A-374 | - | - | - | - | MG-1 | - |
| A-845 | IRA-67/68 | - | - | - | CA-9222 | - | - | WA-11 |

Strong Acid Cation Resins

| | | | | | | | | |
|----------|-------------|-----------|--------|----------|---------|-------|-------|--------|
| C-100E | IR-120 | C-20A/225 | HCR-SE | C-300 | - | KPS | CF/L | - |
| | IMAC HP III | - | - | - | S-100LF | - | - | - |
| C-100 | IR-120 | C-20 | HCR-W2 | - | S-100 | - | CF | SK-1B |
| C-100X10 | IR-122 | C-255 | HGR-W2 | C-300ASR | S-115 | - | C-250 | SK-110 |
| C-120E | IR-118 | C-206A | - | C-322 | S-109 | KP-6 | CFA | SK-106 |
| C-145 | IMAC C 8P | - | - | C-300P | - | - | CFS | - |
| C-150 | 252 | C-26 | 88 | - | SP-112 | KS-11 | CFZ | PK-220 |
| C-160 | 200 | C-265 | MSC-1 | - | - | - | C-360 | - |

Weak Acid Cation Resins

| | | | | | | | | |
|--------|----------------|-------|-------|-------|--------|-------|-----|-------|
| C-105 | IRC-86 | C-433 | CCR-2 | C-101 | CNP | - | CC | WK-11 |
| C-105E | IMAC HP332/333 | - | - | - | CNPLF | - | - | - |
| C-106 | IRC-76 | C-464 | MWC-2 | - | CNP-80 | CA-20 | CNN | WK-20 |
| C-116 | IRC-50 | - | - | - | - | - | - | WK-10 |
| C-116E | HP 334 | - | - | - | - | - | - | - |
| C-118 | - | - | - | - | - | - | - | - |
| C-118E | - | - | - | - | - | - | - | - |

NUCLEAR GRADE RESIN RANGE

| | | | | | | | | |
|------------|---------|-----------|-----------------|---|---------|---|---|-------|
| NRW-100 | IRN-77 | ARC-9351 | - | - | S-100KR | - | - | SKN-1 |
| NRW-100L17 | IRN-218 | ARC-9353 | - | - | - | - | - | - |
| NRW-160 | - | - | - | - | DN-KR | - | - | - |
| NRW-400 | IRN-78L | ARA-9366 | "Chloride Free" | - | S-500KR | - | - | SAN-1 |
| NRW-450 | - | - | - | - | - | - | - | - |
| NRW-37 | IRN-150 | ARA-9281D | - | - | - | - | - | - |
| NRW-39 | - | ARA-9381 | - | - | - | - | - | - |

**PUROFINE RANGE
Strong Acid Cation Resins**

| | | | | | | | | |
|-------------|----------------|------------|---|---|---|---|---|---|
| PFN C-100EF | HP-111 F | - | - | - | - | - | - | - |
| PFC-100H | AMBERJET 1200H | MARATHON C | - | - | - | - | - | - |

Strong Base Anion Resins

| | | | | | | | | |
|---------|---------------|-------------|---|---|---|---|---|---|
| PFA-400 | AMBERJET 4200 | MARATHON A1 | - | - | - | - | - | - |
| PFA-300 | - | MARATHON A2 | - | - | - | - | - | - |

PRODUCTS FOR QUALITY WATER



**ECONOSOFT
WORKS HARD FOR
YOU**



Why should you use a water softener in **LAUNDRIES?**

DWC Water softening systems can help you control costs by using less detergent, less expensive detergent and making it work more efficiently. And eliminating hard water deposits that reduce flow and pressure and cause corrosion and leaks in water heaters means longer machine life and lower maintenance.

DWC water softening systems remove harsh minerals that allow stains to set and make fabrics rough and scratchy. Eliminating these makes fabric last longer, helps prevent

THE DWC ECONOSOFT DELIVERS - NO MATTER WHAT SIZE WASHER YOU USE!

| WASHER SIZE | AVG GAL WATER/LOAD | AVG LOADS/DAY | MACHINES ON-SITE | MODEL | FIG. NO. | PRICE |
|-------------|--------------------|---------------|------------------|--------------|----------|-------|
| 35 LBS. | 135 | 8 | 3 | ES48C(COLD) | 42865 | |
| | | | | ES48H(HOT) | 67543 | |
| 50 LBS. | 206 | 8 | 3 | ES64C(COLD) | 42868 | |
| | | | | ES64H(HOT) | 67535 | |
| 75 LBS. | 364 | 8 | 3 | ES120C(COLD) | 40890 | |
| | | | | ES120H(HOT) | 67552 | |

Why should you use a water softener in **DISHROOMS?**

A DWC water treatment solution can soften your problems and increase your hard cash.

DWC water softening systems can help you control costs by using less expensive detergent, less detergent, less wetting agent and making them work more efficiently. And eliminating hard water deposits that reduce flow and pressure and use corrosion and leaks in water heaters means longer machine life and lower maintenance costs. Rinse jets won't clog with mineral deposits and heating elements won't foul. DWC water softening systems remove harsh minerals that cause filming on glass and flatware leaving all your tableware cleaner increasing customer satisfaction.

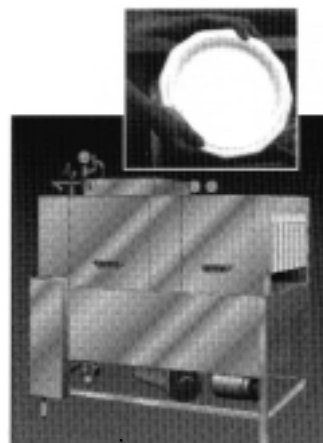

THE DWC ECONOSOFT DELIVERS - NO MATTER WHAT SIZE WASHER YOU USE!

| TYPE | GAL PER CYCLE | GAL PER HOUR | HRS PER DAY | MODEL | FIG. NO. | PRICE |
|--|---------------|--------------|-------------|---|----------|-------|
| Undercounter & single rack low temp. (140°) | 1.5 | 55 | 8 | ES16H | 67531 | |
| Double tank low temp. (140°) | 3.8 | 140 | 8 | ES24H | 67572 | |
| Undercounter & single rack high temp. (180°) | 1.5 | 80 | 8 | ES16HT stainless steel tank & distributor | 67532 | |
| Conveyor & flight type high temp (180°) | 1.5 | 360 | 8 | ES64HT stainless steel tank & distributor | 67569 | |
| Standard 32,000 grain cold water softener (100°) | | | | DWC32F | 42862 | |

Low temp up to 140° F rinse
High temp up to 180° F rinse
Water at 15 grains hardness.

**CHEM-TECH CHEMICAL FEED PUMPS
SERIES 100 AND 150
CHEMICAL METERING PUMPS**

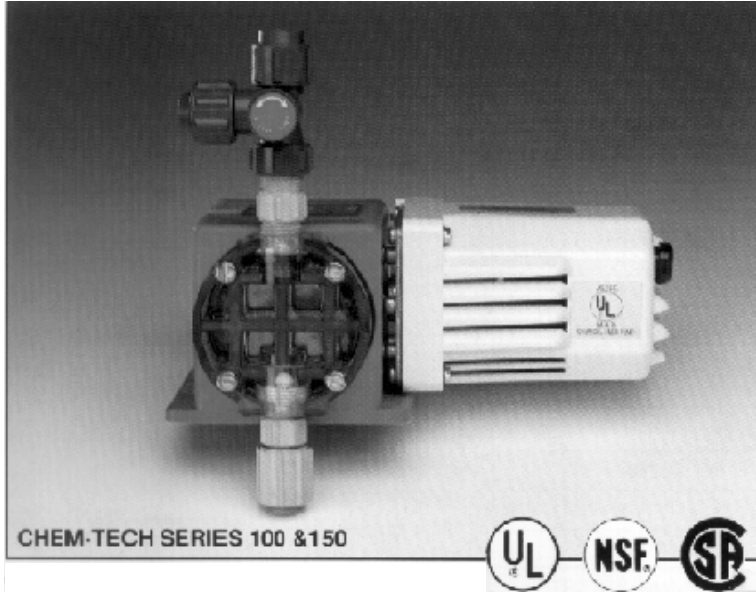

These positive displacement, diaphragm feed pumps are versatile, easy to maintain, and are engineered to satisfy a wide range of water treatment applications.

- fully adjustable output over entire operating range
- lifetime lubricated, sealed, self-maintaining gear train
- strong, chemical resistant, flame retardant housing
- operating pressures up to 100 psi
- metal reinforced, short stroke diaphragm for extra long life

THE SERIES 100D pumps feature...

- exclusive dual cam design with independent output controls for maximum operating efficiency
- dual head assemblies for feeding two different chemicals

HEAD: SAN (optional PVC, polypropylene, PPS, 316SST)

DIAPHRAGM: Hypalon (optional viton, silastic, EPDM, Teflon coated)

VALVE SEATS: Hypalon (optional viton, silastic, EPDM)

GASKETS: Teflon

DISCHARGE TUBING: Polyethylene

SUCTION TUBING: Flexible PVC

BALL CHECKS: Ceramic (optional Teflon)

FITTINGS: PVC (optional polypropylene, PPS, 316SST)

DIMENSIONS: 6 + 3/4"H x 8 + 7/8"W x 7 + 1/4"D (SERIES 100 & 150)
6 + 3/4"H x 12 + 5/16"W x 7 + 1/4"D (SERIES 100D)

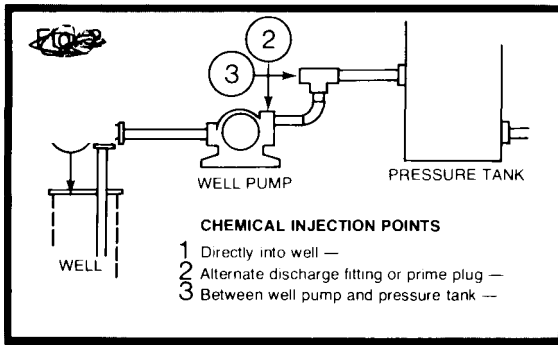

| SERIES/MODEL | *GAL. PER DAY | *LTR. PER DAY | LTR. PER DAY | MAX PRESSRE (PSI) | STROKES PER MIN. | SHIP WGT (LBS) | FIG. NO. | PRICE |
|--------------|---------------|---------------|--------------|-------------------|------------------|----------------|----------|-------|
| 100/003 | 3 | 11.36 | 100 | 7 | 8 | .30 | 42784 | |
| 100/007 | 7 | 26.50 | 100 | 13 | 8 | .42 | 42785 | |
| 100/015 | 15 | 56.78 | 100 | 25 | 8 | .59 | 42786 | |
| 100/024 | 24 | 90.84 | 100 | 51 | 8 | .75 | 50068 | |
| 100/030 | 30 | 113.55 | 100 | 51 | 8 | .79 | 25231 | |
| 100/068 | 68 | 257.38 | 560 | 51 | 8 | 1.0 | 44430 | |
| 150/100 | 100 | 378.50 | 60 | 70 | 8 | 1.0 | 57873 | |

*NOMINAL FEED RATE AT MAXIMUM STROKE SETTING

**CHEM-TECH CHEMICAL
METERING PUMPS**

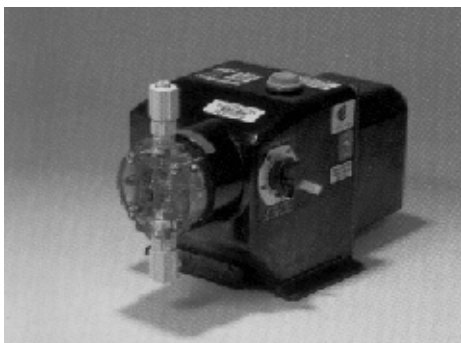

**SERIES 200
CHEMICAL
METERING PUMPS**

These high pressure diaphragm feed pumps provide excellent efficiency under the most strenuous conditions and are popular for in-plant process water and boiler water treatment and other industrial applications.

*Fully adjustable output over entire operating range

*Heavy duty, fan-cooled motor and oil immersed gear box for high performance.

*Metal reinforced, short stroke diaphragm for long life

*High torque motor-gear coupling ensures start-up under maximum head pressure.

HEAD: SAN(optional PVC, PP, PPS, 316SST)

DIAPHRAGM & VALVE SEATS: Hypalon (optional viton, silastic, EPDM, Teflon coated)

GASKETS: Teflon

BALL CHECKS: Ceramic (optional Teflon 316SST)

FITTINGS: PVC (optional PPS, polypropylene, 316SST)

DISCHARGE TUBING: Polyethylene

SUCTION TUBING: Flexible PVC

DIMENSION: 7 + 3/4"X7 1/4"X13"

(SERIES 200)

| MODEL | GAL. PER DAY | LTR. PER DAY | MAX. PRSSRE (PSD) | SHIP WGHT (LBS) | FIG. NO. | PRICE |
|-----------|--------------|--------------|-------------------|-----------------|----------|-------|
| 200/210 | 10 | 37 | 150 | 17 | | |
| 200/215 | 15 | 56 | 150 | 17 | | |
| 200/220 | 20 | 75 | 150 | 17 | 43375 | |
| 200/230 | 30 | 113 | 125 | 17 | | |
| 200/240 | 40 | 151 | 125 | 17 | 25233 | |
| 200/260 | 60 | 227 | 125 | 17 | 43377 | |
| 200/280 | 80 | 302 | 100 | 17 | 43379 | |
| 200/2-100 | 100 | 378 | 100 | 17 | | |
| 200/2-120 | 120 | 454 | 80 | 17 | | |

DIAPHRAGM PUMPS

For additional information call: 610-275-4453 or Fax: 610-279-6299
Please call for current prices.

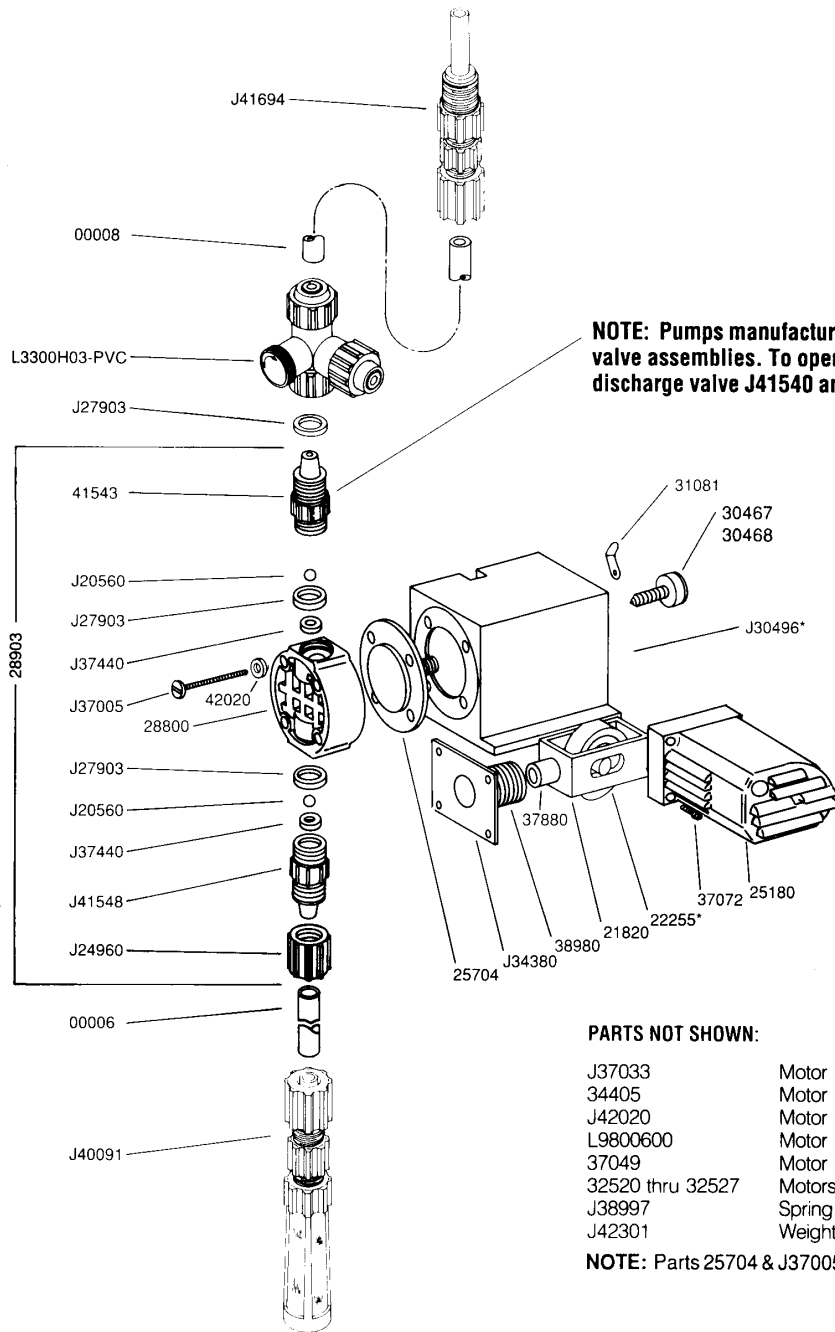

NOTE: Pumps manufactured prior to 2/92 do not include bleed valve assemblies. To operate pump without bleed valve order discharge valve J41540 and coupling nut J24960.

PARTS NOT SHOWN:

- J37033 Motor Cover Plate Screw, 3 required
- 34405 Motor Cover Plate
- J42020 Motor Mounting Washers, 3 required
- L9800600 Motor Mounting Nuts, 3 required
- 37049 Motor Studs, 3 required
- 32520 thru 32527 Motors — Specify Model
- J38997 Spring, Injection/Back Check
- J42301 Weight, Strainer

NOTE: Parts 25704 & J37005 are not included with 28903 Assembly.



A Unit of IDEX Corporation

27101 AIRPORT ROAD, PUNTA GORDA, FL 33982

CHEMTECH/PULSAFEEDER SERIES 100 PARTS

| NEW PART # | OLD PART # | DESCRIPTION | FIG. NO. | PRICE |
|--------------|------------|--|----------|-------|
| 00006 | 277P | Suction tubing per foot | | |
| 00008 | 279P | discharge tubing per foot | | |
| **J20560 | 278P | Ball check, ceramic | 32304 | |
| 21820 | 607P | Bracket | | |
| 22255 | 613P | Cam bearing assy., 003, 007, 015, 030 | | |
| 22256 | 613P | Cam bearing assy., 024 | | |
| 22257 | 613P | Cam bearing assy., 068, 100 | | |
| J24960 | | Coupling Nut | 32299 | |
| 25180 | 625P | Motor cover | | |
| **25704 | 228P | Diaphragm, Hypalon | 32298 | |
| J26780 | 245P | Injection fitting | 32302 | |
| J27903 | 237P | Gasket, teflon | 33358 | |
| **28800 | 242P | Head, Acrylic | 32300 | |
| **J28801 | 296P | Head, PVC | | |
| **28903 | A51P | Head Assembly, acrylic | 32309 | |
| 30460 | 608P | Output adjustment knob | | |
| 30467 | | Knob assy., includes 30460 and 37089, 068 & 100 | | |
| 30468 | | Know assy., includes 30460 and 37088, all models 068 & 100 | | |
| *J30496 | 603P | Field replacement housing assembly, S100, all except model 024 | | |
| *J30497 | 603P | Field replacement housing assembly, model 024 | | |
| *J30498 | 603P | Field replacement housing assembly, S150, all | | |
| L3300H03-PVC | | Bleed valve | | |
| J34380 | 610P | Backing plate | | |
| J34520 | 283PP | Foot valve plug | | |
| J37005 | 621P | Head mounting bolts S.S. 10x24 (4 required) | | |
| 37032 | 620P | Screw, 10-24 x 1/2" | | |
| 37088 | 652P | Output adjustment screw, 068, 100 | | |
| 37089 | 652P | Output adjustment screw, all models except 068 & 100 | | |
| **J37440 | 638P | Valve seat, hypalon | 33357 | |
| 37880 | 626P | Diaphragm shaft | | |
| 38980 | 252P | Diaphragm return spring | 47081 | |
| J38985 | 285P | Valve spring | 32307 | |
| J40080 | 281P | Strainer, Polypropylene | | |
| **J40017 | A50P | Foot valve and strainer assembly | 32308 | |
| **41543 | 244P | Valve housing, discharge 3/8" | 74349 | |
| **J41548 | 247P | Valve housing, suction | 32303 | |
| J41694 | A52P | Back check valve assembly | 73199 | |
| 42020 | | Washer | | |

*Field replacement housing assembly includes housing with needle bearing (20580) and backing plant (J34380)

**Available in various materials - specify material when ordering.

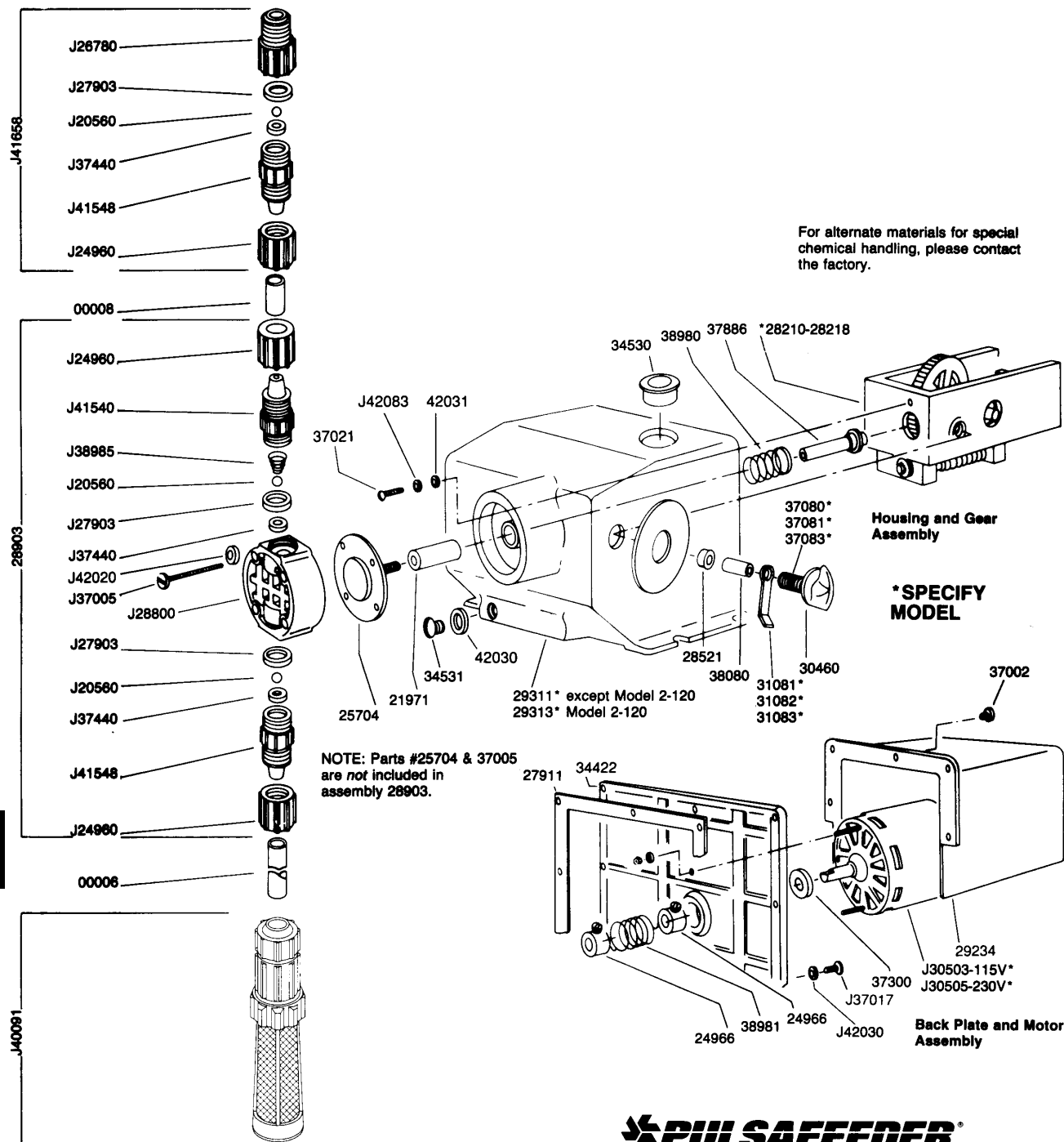

PULSAFEEDER
A Unit of IDEX Corporation

CHEMTECH/PULSAFEEDER SERIES 200 PARTS (CONT'D)

| NEW PART # | OLD PART # | DESCRIPTION | FIG. NO. | PRICE |
|------------|------------|--------------------------------|----------|-------|
| J20560 | 278P | Ball Check, Ceramic | 32304 | |
| 21971 | 683P | Diaphragm shaft bushing | | |
| J24960 | 240P | Coupling nut | 32299 | |
| 24966 | 680P | Shaft coupling (2 required) | | |
| 25704 | 228P | Diaphragm, hypalon | 32298 | |
| J26780 | 245P | Injection fitting | 32302 | |
| J27903 | 237P | Gasket, teflon | 33358 | |
| 27911 | 225P | Gasket | 48961 | |
| 28800 | 242P | Head Acrylic | 32300 | |
| 28903 | A51P | Head assembly | 32309 | |
| 30460 | 266P | Output adjustment knob | | |
| J30503 | 273P | Motor 115v | 47083 | |
| J30505 | 273P | Motor 230/260 | | |
| 34422 | 235P | Back plate | | |
| 37300 | 692P | Oil seal | 47082 | |
| J37440 | 638P | Valve seat, hypalon | 33357 | |
| 37886 | 216P | Diaphragm shaft | | |
| 38080 | 640P | Locking sleeve | | |
| 38980 | 252P | Diaphragm, return spring | 47081 | |
| 38981 | 682P | Coupling spring | | |
| J38985 | 285P | Valve spring | 32307 | |
| J40117 | A50P | Foot valve & strainer assembly | 32308 | |
| J41540 | 244P | Valve housing, discharge | 32301 | |
| J41548 | 247P | Valve housing, suction | 32303 | |
| J41658 | A52P | Back check valve assembly | 38665 | |

YOU ARE ALWAYS WELCOME AT DUFF COMPANY!

**VISIT US ANYTIME!
201 EAST LAFAYETTE STREET
NORRISTOWN, PA 19401**



For additional information call: 610-275-4453 or Fax: 610-279-6299
Please call for current prices.

PULSATRON ELECTRONIC METERING PUMPS

KEY FEATURES

Series E Plus

4-20 mADC direct and stop inputs or external pacing and stop inputs are available.
 Auto-Off-Manual switch
 Highly reliable timing circuit
 EMI resistant
 Thermally protected solenoid with auto-reset
 Panel mounted circuit breaker
 Indicator lights
 Bleed valve assembly

Series E, E-DC A Plus and C Plus

Manual function controls for stroke rate and stroke length
 Highly reliable timing circuit
 EMI resistant
 Thermally protected solenoid with auto-reset
 Bleed valve assembly

Series C

Our lowest cost alternative
 Manual function control for stroke length
 Highly reliable timing circuit
 EMI resistant
 Thermally protected solenoid with auto-reset
 Bleed valve assembly

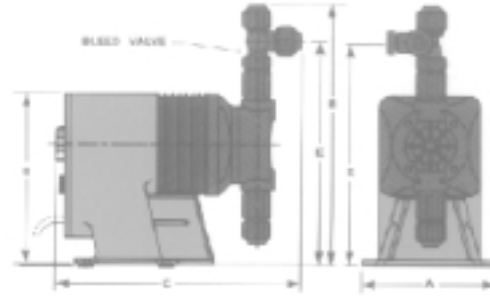
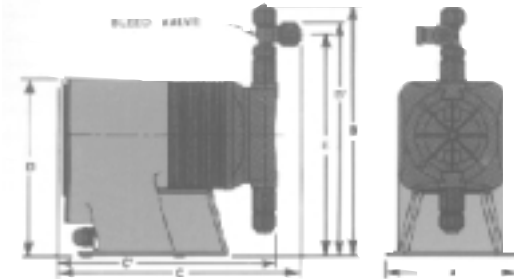

| SERIES E PLUS DIMENSIONS (inches) | | | | | | | | | | |
|-----------------------------------|----------|-----|------|------|------|------|-----|------|----------|-------|
| Fig. No. | Mdl. No. | A | B | B1 | C | C1 | D | E | Ship Wt. | Price |
| 67392 | LPA2 | 5.4 | 10.3 | - | 10.8 | - | 7.5 | 9.0 | 13 | |
| | LPA3 | 5.4 | 10.6 | - | 10.7 | - | 7.5 | 9.2 | 13 | |
| | LPB2 | 5.4 | 10.3 | - | 10.8 | - | 7.5 | 9.0 | 13 | |
| | LPB3 | 5.4 | 10.6 | - | 10.7 | - | 7.5 | 9.2 | 13 | |
| | LPB4 | 5.4 | 10.6 | - | 10.7 | - | 7.5 | 9.2 | 13 | |
| | LPD3 | 5.4 | 10.6 | - | 11.2 | - | 7.5 | 9.2 | 15 | |
| | LPD4 | 5.4 | 10.6 | - | 11.2 | - | 7.5 | 9.2 | 15 | |
| | LPE4 | 5.4 | 10.6 | - | 11.2 | - | 7.5 | 9.2 | 15 | |
| 66541 | LPF4 | 5.4 | 10.6 | - | 11.7 | - | 7.5 | 9.2 | 18 | |
| | LPG4 | 5.4 | 10.6 | - | 11.7 | - | 7.5 | 9.2 | 18 | |
| | LPG5 | 5.4 | 11.0 | - | 11.7 | - | 7.5 | 9.6 | 18 | |
| | LPH4 | 6.2 | 11.0 | - | 11.2 | - | 8.2 | 9.6 | 21 | |
| | LPH5 | 6.2 | 11.3 | - | 11.2 | - | 8.2 | 10.0 | 21 | |
| | LPH6 | 6.2 | 11.3 | - | 11.2 | - | 8.2 | 10.0 | 21 | |
| | LPH7 | 6.1 | 11.7 | - | 11.2 | - | 8.2 | 10.3 | 21 | |
| | LPH8* | 6.1 | - | 10.9 | - | 10.6 | 8.2 | - | 25 | |
| | LPK7 | 6.1 | 11.7 | - | 11.2 | - | 8.2 | 10.3 | 21 | |

Note: Inches x 2.54 = cm

*The LPH8 is designed without a bleed valve available.

| SERIES E DIMENSIONS (inches) | | | | | | | | | |
|------------------------------|---------|-----|------|------|-----|-----|----------|-------|--|
| FIG. NO. | MDL NO. | A | B | C | D | E | SHIP WT. | PRICE | |
| 66543 | LEO2 | 5.0 | 9.6 | 9.6 | 6.5 | 8.2 | 10 | | |
| | LEO3 | 5.0 | 9.9 | 9.5 | 6.5 | 8.5 | 10 | | |
| 44968 | LE12 | 5.0 | 9.6 | 9.6 | 6.5 | 8.2 | 10 | | |
| 66542 | LE13 | 5.0 | 9.9 | 9.5 | 6.5 | 8.5 | 10 | | |
| 69558 | LE14 | 5.0 | 9.9 | 9.5 | 6.5 | 8.5 | 10 | | |
| | LE33 | 5.4 | 10.6 | 11.4 | 7.5 | 9.2 | 15 | | |
| | LE34L | 5.4 | 10.6 | 11.4 | 7.5 | 9.2 | 15 | | |
| | E44 | 5.4 | 10.6 | 11.4 | 7.5 | 9.2 | 15 | | |

Note: Inches x 2.54 = cm

| SERIES A PLUS DIMENSIONS (inches) | | | | | | | | | |
|-----------------------------------|---------|-----|-----|-----|-----|-----|----------|-------|--|
| FIG. NO. | MDL NO. | A | B | C | D | E | SHIP WT. | PRICE | |
| | LB02 | 5.0 | 9.6 | 9.5 | 6.5 | 8.2 | 10 | | |
| | LB03 | 5.0 | 9.9 | 9.5 | 6.5 | 8.5 | 10 | | |
| | LB04 | 5.0 | 9.9 | 9.5 | 6.5 | 8.5 | 10 | | |
| | LB64 | 5.0 | 9.9 | 9.5 | 6.5 | 8.5 | 10 | | |

| SERIES C PLUS DIMENSIONS (inches) | | | | | | | | | |
|-----------------------------------|---------|-----|-----|-----|-----|-----|----------|-------|--|
| FIG. NO. | MDL NO. | A | B | C | D | E | SHIP WT. | PRICE | |
| 69201 | LD02 | 5.0 | 9.6 | 9.5 | 6.5 | 8.2 | 10 | | |
| | LD03 | 5.0 | 9.9 | 9.5 | 6.5 | 8.5 | 10 | | |
| | LD04 | 5.0 | 9.9 | 9.5 | 6.5 | 8.5 | 10 | | |
| | LD54 | 5.0 | 9.9 | 9.5 | 6.5 | 8.5 | 10 | | |

| SERIES C DIMENSIONS (inches) | | | | | | | | | |
|------------------------------|---------|-----|-----|-----|-----|-----|----------|-------|--|
| FIG. NO. | MDL NO. | A | B | C | D | E | SHIP WT. | PRICE | |
| 47050 | LC02 | 5.0 | 9.6 | 9.5 | 6.5 | 8.2 | 10 | | |
| | LC03 | 5.0 | 9.9 | 9.5 | 6.5 | 8.5 | 10 | | |
| | LCO4 | 5.0 | 9.9 | 9.5 | 6.5 | 8.5 | 10 | | |
| 59169 | L54 | 5.0 | 9.9 | 9.5 | 6.5 | 8.5 | 10 | | |

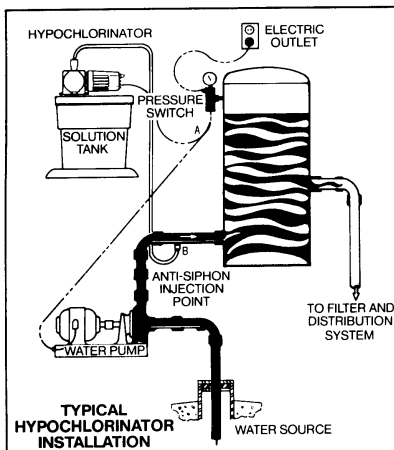

A. The hypochlorinator may be wired in at any point between the pressure switch and the water pump.
 B. Injection point located on the pressure side of the water pump prevents potential damage to pump by concentrated chlorine or precipitants.

CHEMICAL FEED PUMP

Cooling Water Treatment Applications

For each system a survey should be made which will include the following basic information.

1. Tons of refrigeration — 1 ton = 12,000 BTU.
2. Hours of operation per day.
3. Total water capacity of the system.

In addition, you must estimate or calculate the following:

4. Evaporation of water from the system in gallons per minute.
5. From inspection of water, decide on concentration to be maintained.
6. Amount of water to be bled from the system (bleed off in gallons per minute).
7. Total bleed off in gallons per minute per day.
8. Amount of chemical required per day.

Normally speaking, the tons of refrigeration, hours of operation per day, and the total water capacity of the system will be readily available from the mechanical contractor, mechanical engineer, or maintenance superintendent.

Figuring the amount of evaporation in gallons per minute must be determined by the number of tons refrigeration. Two different types of systems:

Using tons refrigeration:

1. **Vapor-Compression System:** Compression systems may use reciprocating, centrifugal, gear, or rotary compressors and any one or more of a variety of refrigerants, depending upon the job.

To obtain evaporation of water from the cooling system, multiply the "tons refrigeration" by the factor 0.03, and the product is the rate of evaporation of water in gpm.

2. **Adsorption Systems:** Systems using heat to raise pressure of the refrigerant instead of a compressor. Adsorption refrigeration relies on the ability of some liquid solutions to adsorb vapors when cold, readily give up when hot.

Multiply the "tons refrigeration" by the factor 0.06, the product is the rate of evaporation of water from the system in gpm.

Total Amount of Water Evaporated Per Day:

The number of gpm of water evaporated/min., as determined by one of the preceding methods, multiplied by 60, equals the number of gallons/hour evaporated. This figure, multiplied by the number of hours of operation/day, will give the total amount of water evaporated per day.

Amount of water to be bled from the system. (Bleed off in gallons per minute.)

1. The amount of water to bleed off from the system each minute is based on the amount of water evaporated per minute — and — on the desired concentration (cycles of concentration) to be maintained in the cooling system.

2. The allowable concentration (AC) to be maintained in a given cooling system will be determined by using the following rules:

(A.) Normally, as a rule of thumb, it is not recommended to use more than five cycles of concentration in a cooling system.

(B.) Allowable concentrations with vapor-compression systems.

1. Without PH Controls:

$$\text{Allowable Concentration} = \frac{40}{\text{TA} \& \text{TH}}$$

TA = Total Alkalinity
TH = Total Hardness

2. With PH Control:

$$\text{Allowable Concentration} = \frac{40}{\text{TH}}$$

Note: PH Control — Feeding acid to a cooling tower requires constant supervision by trained personnel — at best — in most small systems it is risky.

3. Allowable concentrations in adsorption systems:

(A.) **Systems under 75 Tons:**

Determine the maximum allowable concentration in the usual manner. $\frac{40}{\text{TA} \& \text{TH}}$. But in no

case allow more than two cycles of concentration.

(B.) **Systems over 75 Tons:**

Softened water on PH Control should be used. 1. If PH Control is used, figure the allowable concentration = $\frac{40}{\text{TH}}$

2. If softened water is used, figure — $\frac{40}{\text{TA}} + 10\%$.

* Maximum 5 cycles of concentration.

CHEMICAL FEED PUMP

Cooling Water Treatment Applications

After you have determined the desired number of cycles from one of the above rules, the amount of bleed-off to obtain that specific concentration can be determined in accordance with the table to the right.

The rate of evaporation in gallons per minute times the percentage determined by the number of concentrations to be maintained equals the amount of water to be bled off per minute of operation.

| Concentration | Rate of bleed-off as a percent of the rate of evaporation |
|---------------|---|
| 5 | 25% |
| 4 | 33.5% |
| 3 | 50.0% |
| 2.75 | 57.0% |
| 2.5 | 66.0% |
| 2.25 | 80.0% |
| 2.0 | 100% |
| 1.75 | 133% |
| 1.5 | 200% |
| 1.25 | 400% |

Amount of bleed-off in gallons per minute.

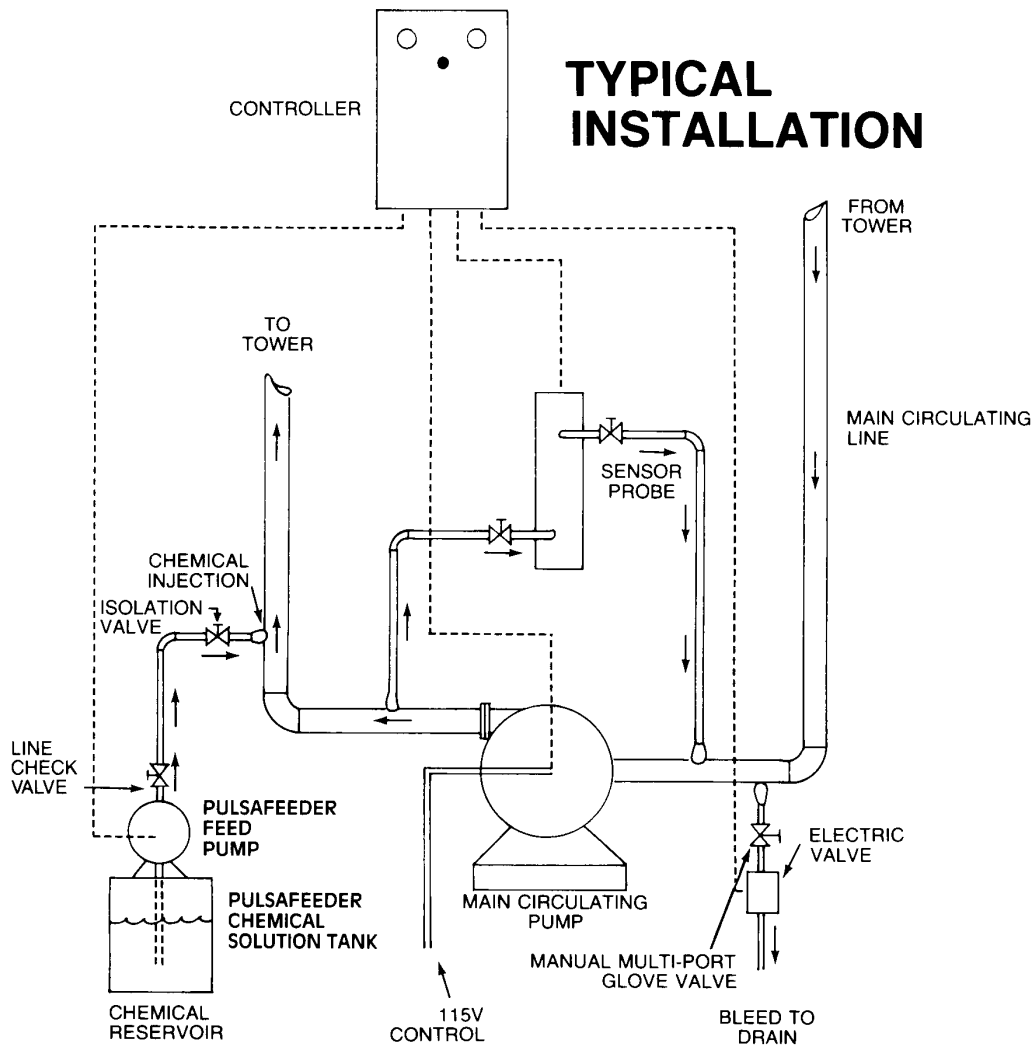

0601759 JR

FLOW METERS



SERIES 10,000 FLOWMETER WITH CONTACTOR

- Specifically designed to control the metering of chemical in direct proportion to the influent flow rate.
- Available with an extensive range of Contactor (pulse) rates.
- Available from .25 gallon per contact to 50 gallons per contact.
- Internal plastic components are impervious to most chemicals.
- Contactor and register are hermetically sealed for years of trouble free operation.

SERIES 10,000 FLOWMETER-CONTACTOR SPECIFICATIONS

| | | | | | |
|-------------------------|--|---|------------------------------|--------------------------------|--------------------------------|
| Type: | 3/4" - 2" | 3" - 6" | Temperature | | |
| Housing: | Multi-Jet Cast Bronze | Turbine Cast Iron | Limitations: | 33 - 105 Degrees Fahrenheit | 33 - 105 Degrees Fahrenheit |
| Drive Mechanism: | Gear | Gear | Pressure Limitations: | 150 PSI Maximum | 250 PSI Maximum |
| Register: | Totalizing with three sweep pointers, 0.1, 1.0 and 10 gallons per revolution | Register in 100's of gallons. Maximum reading ranges from 100 million to 1 billion, depending upon meter. | Mounting: | Machined coupling-Horizontal | Flange-Horizontal |

| FIG. NO. | FLOW METER | GALLONS | PRICE |
|----------|----------------|--------------------|-------|
| 77347 | 1/2 Flow Meter | | |
| 61916 | 3/4 Flow Meter | 0.25 Gal per pulse | |
| 63822 | 3/4 Flow Meter | 0.10 Gal per pulse | |
| 65727 | 3/4 Flow Meter | 0.04 Gal per pulse | |

CHEM-TECH MIXERS

MIXERS

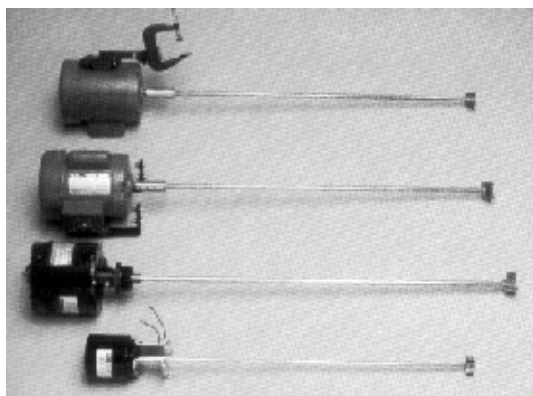

CHEM-TECH MIXERS are dynamically balanced for smooth operation and available with a variety of motors, mounting systems, and impellers.

MOTORS: Open, totally enclosed, and explosion proof motors are available in the following horsepower: 1/20, 1/4, 1/3, 1/2, and 1 hp.

MOUNTS: A choice of clamp, bracket, thread or flange mounts is available.

IMPELLERS: The CHEM-TECH stainless steel impeller offers excellent resistance to abrasion and corrosion and is available in various sizes to provide maximum mixing action for each motor model.

| FIG. NO. | MODEL # | DESCRIPTION | PRICE |
|----------|----------------|-----------------------|-------|
| 49316 | 42747-B-M-TE-H | 1/20 HP bracket mount | |
| 50545 | 42748-F-M-TE-H | 1/20 HP bracket mount | |
| 47051 | 42742-B-1-O-H | 1/4 HP bracket mount | |
| 49726 | 42749-F-2-0-H | 1/3 HP flange mount | |

For additional information call: 610-275-4453 or Fax: 610-279-6299
Please call for current prices.

CHEMICAL FEED PUMPS







STENNER

Stenner chemical feed pumps utilize the simple concept of peristaltic action. Pump action is achieved by moving a system of rollers against a flexible tube. As the open and closed sections of the tube are moved forward by the rollers, fluids and slurries are pulled through the pump and discharged from the output side.

MODELS AND OUTPUTS

The chart below shows the variety of pumps available. For special purpose applications, special voltages and frequencies, custom manufactured modes are available upon request.

STENNER PERISTALTIC PUMPS

| MECHANICAL CONTROL MODELS | | | FIXED OUTPUT MODELS | | | | | | | | | | | | |
|--|--|---|---|--|----------------------------------|----------------------------|-----|-------|-------|--|--|--|--|--|--|
| SINGLE HEAD | DOUBLE HEAD | DOUBLE HD DUALCONTROL | SINGLE HEAD | DOUBLE HEAD | 24 HOUR OUTPUT (Maximum) US GALS | MAX DISCHARGE PRESSURE PSI | | | | | | | | | |
|  |  |  |  |  | 2.2 | 100 | | | | | | | | | |
| 45M-HP2 | | | 45MP-HP2 | | | | | | | | | | | | |
| <table border="1"> <tr> <th>Voltage</th> <th>Fig. No.</th> <th>Price</th> </tr> <tr> <td>120</td> <td>80230</td> <td></td> </tr> <tr> <td>230</td> <td>77176</td> <td></td> </tr> </table> | Voltage | Fig. No. | Price | 120 | 80230 | | 230 | 77176 | | | | | | | |
| Voltage | Fig. No. | Price | | | | | | | | | | | | | |
| 120 | 80230 | | | | | | | | | | | | | | |
| 230 | 77176 | | | | | | | | | | | | | | |
| 45M-HP10 | | | 45MP-HP10 | | 10 | 100 | | | | | | | | | |
| 85M-HP5 | | | 85MP-HP5 | | 4.5 | 100 | | | | | | | | | |
| 85M-HP17 | | | | | 17 | 100 | | | | | | | | | |
| <table border="1"> <tr> <th>Voltage</th> <th>Fig. No.</th> <th>Price</th> </tr> <tr> <td>120</td> <td>78631</td> <td></td> </tr> <tr> <td>230</td> <td>78632</td> <td></td> </tr> </table> | Voltage | Fig. No. | Price | 120 | 78631 | | 230 | 78632 | | | | | | | |
| Voltage | Fig. No. | Price | | | | | | | | | | | | | |
| 120 | 78631 | | | | | | | | | | | | | | |
| 230 | 78632 | | | | | | | | | | | | | | |
| | 100DM-HP5 | 100MDC-HP5 | | 100DMP-HP5 | 4.5 | 100 | | | | | | | | | |
| | 100DM-HP20 | 100MDC-HP20 | | 100DMP-HP20 | 20 | 100 | | | | | | | | | |
| | | <table border="1"> <tr> <th>Fig. No.</th> <th>Price</th> </tr> <tr> <td>78069</td> <td></td> </tr> </table> | Fig. No. | Price | 78069 | | | | | | | | | | |
| Fig. No. | Price | | | | | | | | | | | | | | |
| 78069 | | | | | | | | | | | | | | | |
| | 170DM-HP9 | 170MDC-HP9 | | 170DMP-HP9 | 9 | 100 | | | | | | | | | |
| | 170DM-HP34 | 170MDC-HP34 | | 170DMP-HP34 | 34 | 100 | | | | | | | | | |
| | <table border="1"> <tr> <th>Voltage</th> <th>Fig. No.</th> <th>Price</th> </tr> <tr> <td>120</td> <td>78633</td> <td></td> </tr> <tr> <td>230</td> <td>78634</td> <td></td> </tr> </table> | Voltage | Fig. No. | Price | 120 | 78633 | | 230 | 78634 | | | | | | |
| Voltage | Fig. No. | Price | | | | | | | | | | | | | |
| 120 | 78633 | | | | | | | | | | | | | | |
| 230 | 78634 | | | | | | | | | | | | | | |

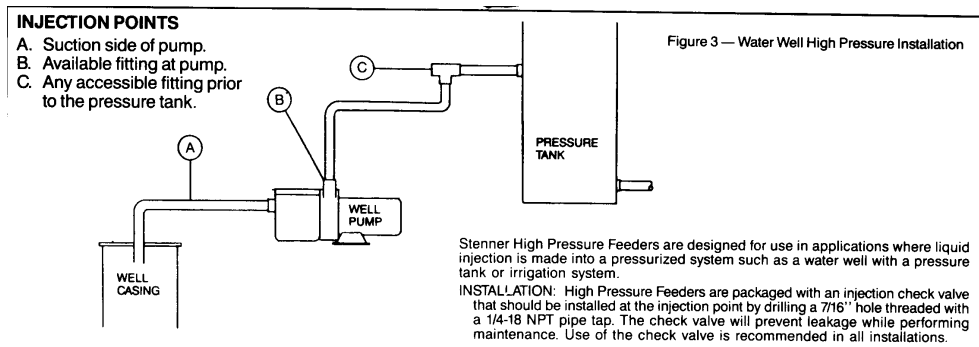

STENNER TUBE HOUSING PARTS

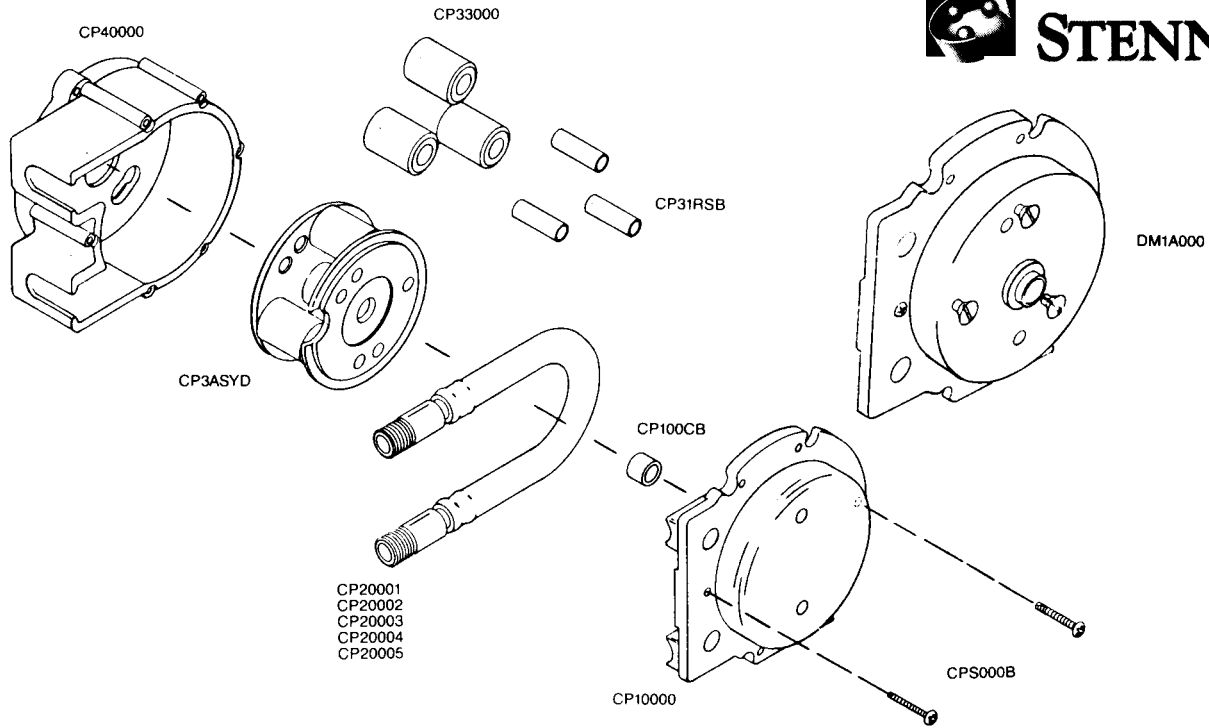

| FIG. NO. | PART NO. | DESCRIPTION | PRICE |
|---|----------|---|-------|
| TUBE HOUSINGS COMPLETE AND PARTS | | | |
| 78667 | CP10000 | Tube housing cover with bushing | |
| | CP100CB | Tube housing cover bushing only | |
| 78669 | CP3ASYD | Roller assembly complete "D" shaft | |
| | CP31RSB | Roller shaft bushing only | |
| | CP33000 | Standard roller | |
| 78668 | CP40000 | Tube housing only | |
| | CPS000B | Tube housing cover screw | |
| 78670 | CPTH1D | Tube housing complete 45-1 "D" | |
| | CPTH2D | Tube housing complete 45-2 "D" | |
| | CPTH3D | Tube housing complete 45-3 "D" | |
| | CPTH4D | Tube housing complete 45-4 "D" | |
| | CPTH5D | Tube housing complete 45-5 "D" | |
| DM AND MDC MODEL ADAPTER TUBE HOUSING COMPLETE AND PARTS | | | |
| | DM1A000 | Adapter tube housing cover with bushing | |
| | DM1ATC1 | Adapter tube housing complete 45-1 | |
| | DM1ATC2 | Adapter tube housing complete 45-2 | |
| | DM1ATC3 | Adapter tube housing complete 45-3 | |
| | DM1ATC4 | Adapter tube housing complete 45-4 | |
| | DM1ATC5 | Adapter tube housing complete 45-5 | |
| TUBE ASSEMBLIES FOR ALL STENNER FEEDERS | | | |
| 78671 | CP20001 | #45-1 tube assembly W/E | |
| 78672 | CP20002 | #45-2 tube assembly W/E | |
| | CP20003 | #45-3 tube assembly W/E | |
| | CP20004 | #45-4 tube assembly W/E | |
| | CP20005 | #45-5 tube assembly W/E | |

For additional information call: 610-275-4453 or Fax: 610-279-6299
 Please call for current prices.

STENNER MISCELLANEOUS ACCESSORIES

| FIG. NO. | PART NO. | DESCRIPTION | PRICE |
|----------|----------|--|-------|
| 78656 | AK10000 | Connecting nut 1.4" | |
| 78657 | AK20000 | Ferrule 1/4" | |
| | AK30000 | PVC injection fitting w/ ferrule and nut | |
| | AK4002B | 20' x 1/4" black lead tube | |
| | AK4002W | 20' x 1/4" white lead tube | |
| | AK4010B | 100' x 1/4" black lead tube | |
| | AK4010W | 100' x 1/4" white lead tube | |
| | AK4100B | 1000' x 1/4" black lead tube | |
| | AK4100W | 1000' x 1/4" white lead tube | |
| | CPACKIT | 1/4" accessory kit (1 PVC injection fitting, 1 feeder tube assembly, 2 connecting nuts, 20' x 1/4" white lead tube, 2-1/4" ferrules). | |
| | HPACKIT | 1/4" high pressure accessory kit (1 injection check valve, 1 HP feeder tube assembly, 2 connecting nuts, 20' x 1/4" white lead tube, 2-1/4" ferrules). | |
| | MAACKIT | 3/8" accessory kit (1 PVC injection fitting, 1 feeder tube assembly, three 3/8" adapter nuts, three 3/8" adapter nuts, thread 3/8" lead tube adapters, 20' x 3/8" white lead tube). | |
| | MAADPTR | 3/8" lead tube adapter | |
| | MANUT00 | 3/8" adapter nut | |
| | MALT002 | 20' x 3/8" lead tube | |
| | MALT010 | 100' x 3/8" lead tube | |
| | MALT100 | 1000' x 3/8" lead tube | |
| 78658 | MACW000 | Clay lead tube weight | |
| | MAFVSST | Stenner foot valve strainer | |
| | MASST00 | Stenner suction line strainer | |
| 77764 | MAGCSGR | Gearcase grease | |
| | MAMBOIL | Motor bearing oil | |
| | | CHECK VALVE PARTS | |
| | CVDBKIT | Stenner check valve kit 1/4" | |
| | CVDB3/8 | Stenner check valve kit 3/8" | |
| 78673 | CVDBINJ | Stenner injection check valve 1/4" | |
| | CVDBINL | Stenner in-line check valve 1/4" | |
| | CVDBFDR | Stenner at-the-feeder check valve 1/4" | |
| | CVDB000 | Check valve duckbill only | |
| 78674 | CVDBCVB | Check valve body only | |
| | CVDBCON | Check valve connector | |
| | CVIJFTG | Check valve injection fitting only | |
| | CVILFTG | Check valve in-line fitting only | |

STENNER FEED RATE CONTROL PARTS

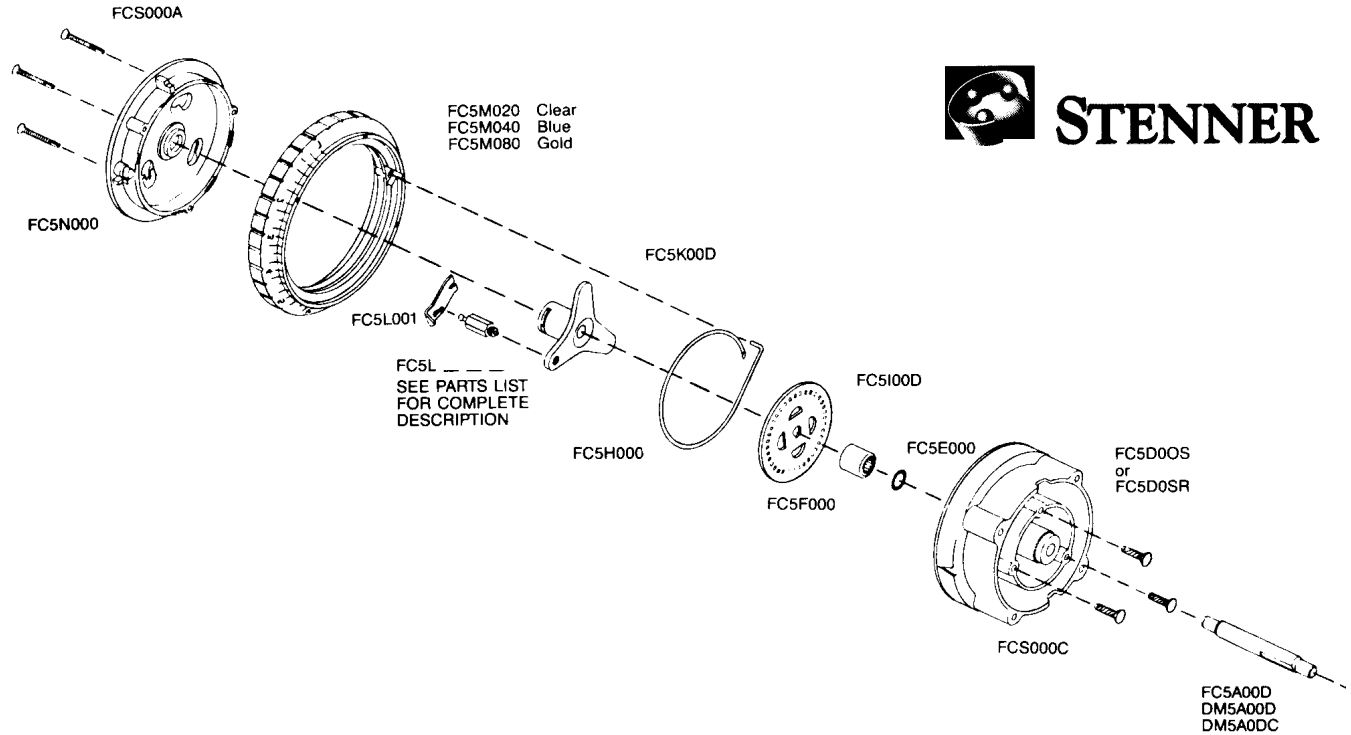

| FIG. NO. | PART NO. | DESCRIPTION | PRICE |
|----------|----------|-------------------------------------|-------|
| | | FEED RATE CONTROLS AND PARTS | |
| | FC5040D | 45M feed rate control comp "D" | |
| | FC4080D | 85M feed rate control comp "D" | |
| | DM5040D | 100DM feed rate control comp "D" | |
| | DM5080D | 170DM feed rate control comp "D" | |
| | DM504DC | 100MDC feed rate control comp "D" | |
| | DM508DC | 170MDC feed rate control comp "D" | |
| 78660 | FC5A00D | 45/85M mainshaft | |
| | DM5A00D | 100/170DM mainshaft | |
| | DM5A0DC | 100/170MDC mainshaft | |
| | FC5D00S | Feed rate housing (outside sale) | |
| | FC5D0SR | Feed rate housing (shop repair) | |
| | FC5E000 | 3/8" O-ring seal | |
| | FC5F000 | Roller clutch | |
| 78665 | FC5H000 | Variablecam | |
| 78664 | FC5100D | "D" index plate | |
| | FC5K00D | Brass index spider "D" | |
| 78663 | FC5LASY | Index pin assembly with lifter | |
| 78779 | FC5L001 | Index pin lifter only | |
| | FC2L002 | Index pin only | |
| | FC5L003 | Index pin holder only 3/8" hex | |
| | FC5L005 | Index pin spring only | |
| | FC5M020 | Clear dial ring - 25M | |
| | FC5M040 | Blue dial ring 45M/100DM/100MDC | |
| | FCM080 | Gold dial ring 85M/170DM/170MDC | |
| | FC5N000 | Feed rate mounting plate | |
| | FCS000A | Feed rate mounting plate "A" | |
| | FCS000C | Feed rate mounting rivet "C" | |

For additional information call: 610-275-4453 or Fax: 610-279-6299

Please call for current prices.

STENNER CHECK VALVE

INSTRUCTIONS FOR INSTALLING A STENNER IN-LINE CHECK VALVE AT THE FEEDER OUTLET FITTING.

Parts Required: 1 Stenner in-line check valve assembled as follows, Check valve connector, check valve body, check valve duckbill, check valve connector, in-line fitting (Figure 13A)
 Assembled all parts finger tight. Note direction of arrow which is the direction of fluid flow. Install the check valve onto the "out" tube fitting finger tight. Fasten the lead tube to the check valve using the 1/4" ferrule and connecting nut. **DO NOT USE TOOLS.** Turn the feeder on. Check for leaks.

INSTRUCTIONS FOR INSTALLING A STENNER IN-LINE CHECK VALVE



STENNER

Parts Required: 1 Stenner in-line check valve assembled as follows, Check valve body, check valve duckbill, check valve connector, in-line fitting (Figure 13B)
 Assembled all parts finger tight. Note direction of arrow which is the direction of fluid flow. The check valve may now be installed in series with the output tubing. Cut the outlet tubing at any convenient point. Connect the check valve to the output tubing using a 1/4" ferrule and connecting nut to fasten the lead tube to each in-line fitting. **DO NOT USE TOOLS.** Turn the feeder on. Check for leaks.

INSTRUCTIONS FOR INSTALLING A STENNER INJECTION CHECK VALVE

Parts Required: 1 Stenner injection check valve assembled as follows, Check valve body, check valve duckbill, check valve connector, check valve injection fitting. Note the groove on the injection fitting which identifies the 1/4" NPT threads (Figure 13C).

MAINTENANCE: Should stoppage occur, the check valve can be completely disassembled for cleaning. Insure that all openings are free and clear of debris. Remove all calcification. All parts re readily available from the factory.

FIGURE 13 A — STENNER CHECK VALVE AT FEEDER (CVDBFDR)

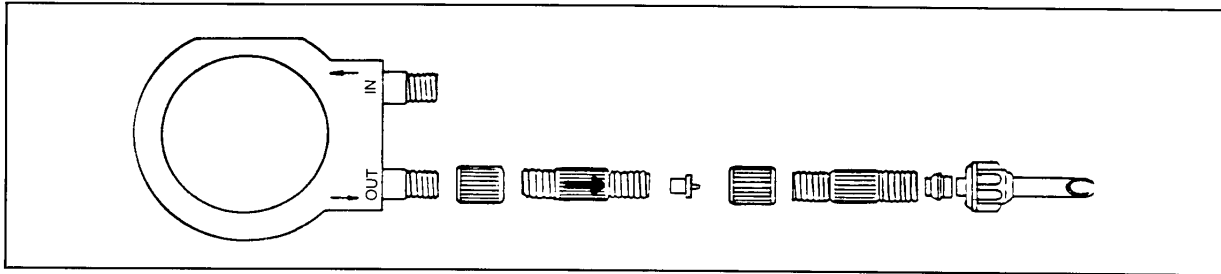

FIGURE 13B — STENNER IN-LINE CHECK VALVE (CVDBINL)

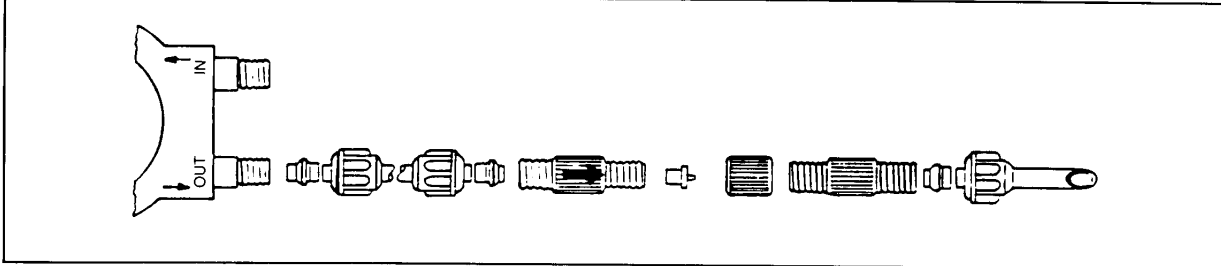
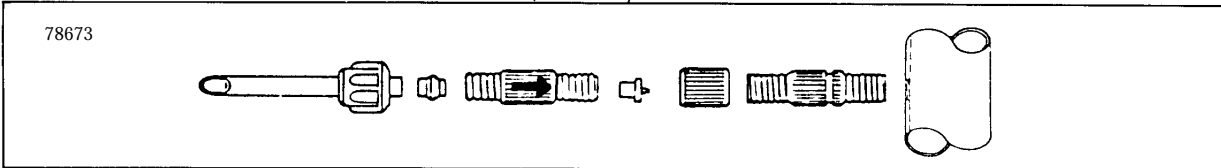
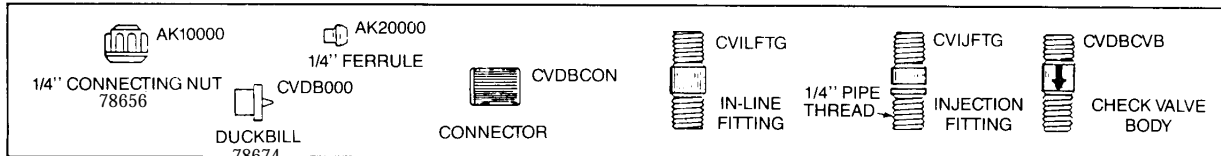

FIGURE 13C — STENNER INJECTION CHECK VALVE (CVDBINJ)



CHECK VALVE PARTS



MECHANICAL (NON-ELECTRIC) CHLORINATOR

APF AUTOMATIC PROPORTIONAL FEEDERS



| | MODEL 2 | MODEL 20 |
|----------------|------------------|------------------|
| FIG. NO. | 38978 | 42581 |
| PRICE | | |
| FLOW CAPACITY | | |
| MAXIMUM | 18 GPM | 18 GPM |
| MINIMUM | .25 GPM | .25 GPM |
| PRESSURE | | |
| MAXIMUM | 80 PSI (5.5 BAR) | 80 PSI (5.5 BAR) |
| MINIMUM | 5 PSI (0.3 BAR) | 5 PSI (0.3 BAR) |
| WATER TEMP | 33°-100°F | 33°-100°F |
| OUTPUT | | |
| MAX FEED RATIO | .002 | .02 |
| MIN FEED RATIO | .0001 | .001 |
| MAX DELIVERY | 52 gpd | 518 gpd |
| MIN DELIVERY | .04 gpd | .36 gpd |
| SUCTION LIFT | 60" | 60" |
| % OF ADDITIVE | | |
| MINIMUM | .01% | .1% |
| MAXIMUM | .2% | 2.0% |

C400 PVC CHLORINATOR

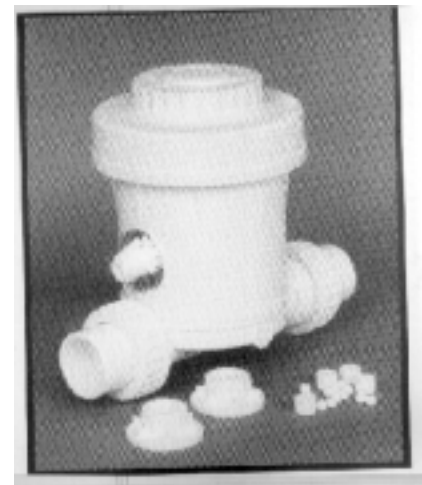
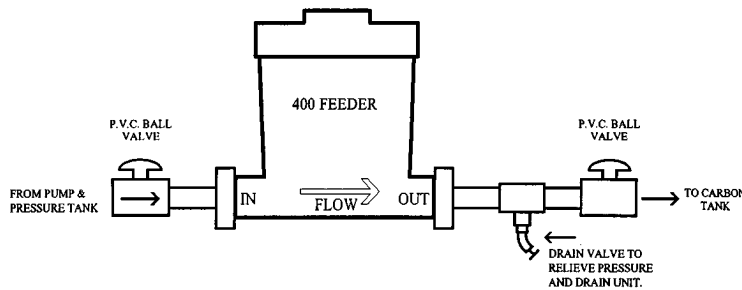

Non electrical chemical feed system. Powered by water pressure and operates only when water is used. The C400 uses chlorine pellets and does require a carbon tank. Union adapters up to 1 1/2".

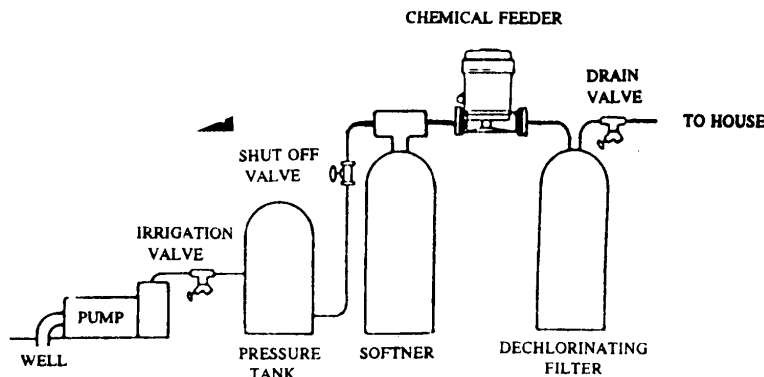

| DESCR. | FIG. NO. | PRICE |
|------------------|----------|-------|
| C400 Chlorinator | 46955 | |
| 14 Lb Pellets | 47505 | |
| 35 Lb Pellets | 38980 | |

For additional information call: 610-275-4453 or Fax: 610-279-6299
 Prices are a guide only. Please call for current prices.

DIRECT WELL TREATMENTS

Well Pro Dry Pellet Chlorinator

WP230 CHLORINATOR

220 Volt, 60/50 Hz, 2 Watts

Pellet Feed Rate: 3 pellets/minute

Pellet Storage: 3 1/2 Lbs.

Dimension: 34" x 11" x 8"

Weight: 12 Lbs.

CHLORINE PELLETS

EPA registered: 5051-1

Active Ingredient: Calcium Hypochlorite (70% available chlorine)

Pellet Weight: .79g (.028 oz.)

| FIG. NO. | PRICE |
|----------|-------|
| 45373 | |

| FIG. NO. | PRICE |
|----------|-------|
| 45390 | |

NOTE: Most water systems require final filtering to completely remove precipitated iron and manganese from the chlorinated water. See your WELL PRO dealer about installing a backwash filter.

TYPICAL PRIVATELY-OWNED WATER SYSTEM

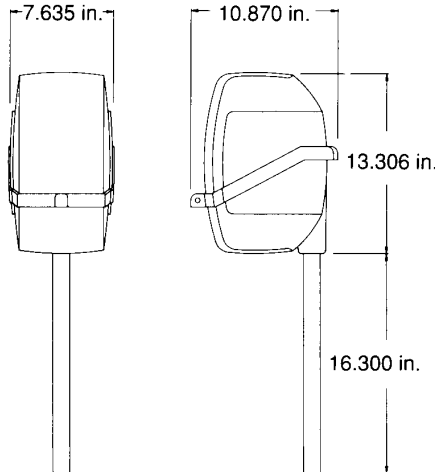
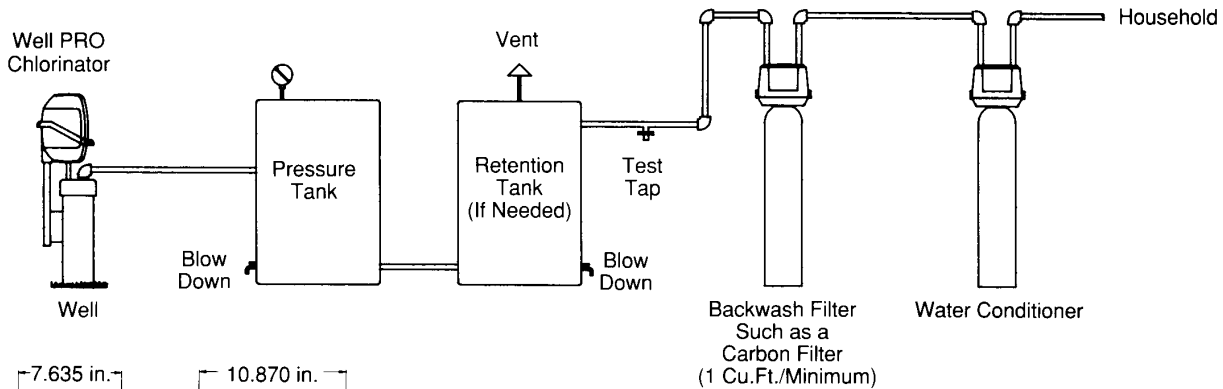

Land-O-Matic Dry Pellet Chlorinator

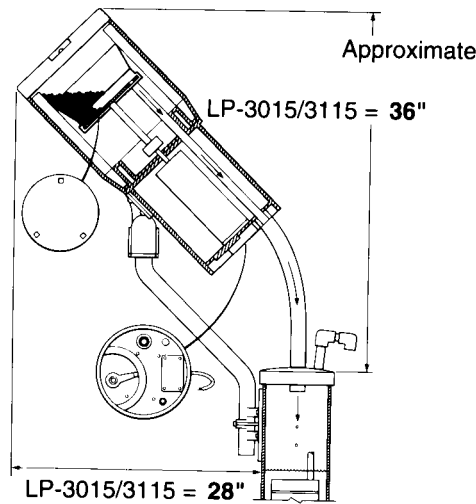

For control of foul smelling, corrosive hydrogen sulfide. Sink staining iron and manganese. Slime-causing, pump clogging iron bacteria, as well as control of fecal and coliform type bacteria.

220 Volt, 60/50 Hz, 31 Watts

Pellet Feed Rate: 6 pellets/minute

Dimension: 12.5 x 15.3 x 30.5 Inches

Weight: 31 Lbs.

CHLORINE PELLETS

EPA Registered 50510-1

Active Ingredient: Calcium Hypochlorite 70%

Active Ingredient: Soluble Material 30%

Pellet Weight: 0.035 oz

Pellet Size: 3/8" diameter x 5.16" long

| MODEL # | FIG. NO. | PRICE |
|---------|----------|-------|
| LP3115 | 38979 | |

| SIZE | FIG. NO. | PRICE |
|-------|----------|-------|
| 14 LB | 47505 | |
| 35 LB | 38980 | |

WATER TREATMENT CHEMICALS

Well Sanitizer

- **Accurate**
- **Economical**
- **Easy to Use**
- **Safe to Store**
- **EPA Registered**

Every new well, or existing water supply system that has been disrupted for service or repair, should be disinfected before it is returned to use. Water in the well and storage tank should be treated with a strong chlorine solution to destroy disease organisms. All pipe lines and fixtures in the distribution system should be rinsed and flushed with chlorinated water.

OSMONICS Autotrol Well Sanitizer chlorinating pellets can be used for well, storage tank or cistern sanitation. the amount of pellets used will depend on the amount of water in the system, to be sanitized.

NOT FOR USE WITH AUTOMATIC FEEDERS

| FIG. NO. | PRICE |
|----------|-------|
| 31604 | |

HOW TO SANITIZE A WATER SYSTEM USING OSMONICS/AUTOTROL WELL SANITIZER

| WELL DIAMETER - INCHES | FOR EACH 100 FEET OF WATER DEPTH USE:* | | |
|------------------------|--|-----------------|-------------------|
| | Weight of Pellets lbs. - oz. | Cups of Pellets | Number of Pellets |
| 2 | 0-1.5 | 1/4 | 40 |
| 3 | 0-3.0 | 2/5 | 80 |
| 4 | 0-6.0 | 3/4 | 140 |
| 5 | 0-8.0 | 1 | 200 |
| 6 | 0-12.0 | 1-1/2 | 300 |
| 8 | 1-5.0 | 2-1/2 | 500 |
| 10 | 2-0 | 4 | 800 |
| 12 | 3-0 | 6 | --- |
| 24 | 12-0 | 24 | --- |
| 36 | 26-0 | --- | --- |

*TO PRODUCE A 400 PPM CHLORINE DOSAGE.



WATER TREATMENT CHEMICALS



SALT - SODIUM CHLORIDE

Most water softening systems pass the water through a bed of special resins, which can exchange sodium ions for "hard" calcium and magnesium ions in the water. Eventually, the resin exhausts its sodium and must be "recharged". This is done by running salt brine, containing sodium, through the resin bed, removing the calcium and magnesium ions from the bed and leaving a new supply of sodium. The brine is produced by the addition of salt to the water softener.

Many industries require softened water for such uses as processing and dyeing textiles, tanning leather, cleaning dairy equipment and commercial laundering. Water softening systems are installed in some municipal water systems for the dual purpose of protecting the plant equipment and better serving industrial and residential users. But the greatest use of water softeners is in homes. People have come to expect quality in their water as in other things in their lives.

| SIZE | FIG. NO. | PRICE |
|-------------------------------------|----------|-------|
| 50 LB BAG SOLAR SALT | 9304 | |
| 80 LB BAG SOLAR SALT | 9301 | |
| 50 LB SALT PELLETS | 46832 | |
| 80 LB SALT PELLETS | 50433 | |
| RED-OUT - 40 LB (HELPS REMOVE IRON) | 47517 | |
| SKID OF 50 LB BAGS SOLAR SALT | 43719 | |
| SKID OF 80 LB BAGS SOLAR SALT | 43720 | |
| SKID OF 50 LB SALT PELLETS | 50652 | |
| SKID OF 80 LB SALT PELLETS | 50661 | |



POTASSIUM CHLORIDE

Substitute for solar salt. Regenerant for all water softeners. Reduces sodium levels in drinking water and chloride levels in discharge.

| FIG. NO. | PRICE |
|----------|-------|
| 45347 | |



IRON OUT

All purpose rust and stain remover.

| SIZE | FIG. NO. | PRICE |
|-----------|----------|-------|
| 18 oz box | 9302 | |
| 5 lb box | 9303 | |
| 50 lb box | 47063 | |

WATER TREATMENT CHEMICALS

RESUP

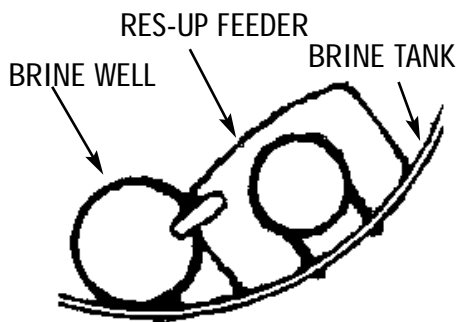

Res-up feeders are easily installed in both round and rectangular brine tanks

RESUP is formulated to penetrate resin bead pores and loosen up iron and other impurities for more thorough cleaning of the resin bed. RESUP FEEDERS enter the proper amount of resup cleaner for each softener regeneration.

| RESUP CLEANER | | |
|---------------|----------|-------|
| SIZE | FIG. NO. | PRICE |
| 1 QT | 44332 | |
| 1 GAL | 46842 | |
| 55 GAL | 51746 | |

| RESUP FEEDER | | | |
|------------------|---------------|----------|-------|
| AVG DLVY PER DAY | COLOR | FIG. NO. | PRICE |
| .4 OZ or 12 cc | Yellow Tubing | 47786 | |
| 1 OZ or 30 cc | Clear Tubing | 47787 | |



A DIVISION OF THE DUFF CO.

Products for Quality Water

Potassium Permanganate

DWC's Potassium Permanganate . . . use to increase your iron filter performance.

Dissolved iron and manganese when oxidized are converted to an insoluble oxide which can then be removed by an iron filtration system.

DWC's Potassium Permanganate, when used in iron filtration systems according to instructions in owners manual, strongly oxidizes the dissolved iron and manganese in water for effective filtration and removal.

| SIZE | FIG. NO. | PRICE |
|--------------|----------|-------|
| 1.5 lb | 9298 | |
| 5 lb. | 38985 | |
| 110 lb. drum | 45456 | |

WATER TREATMENT CHEMICALS

| DESCRIPTION | FIG. NO. | PRICE |
|---|-----------------|--------------|
| S/C GRANULAR ACID - 50 LB drum - white, dry, granular acid removes the hardest mineral and scale deposits in well screen and casing. Increases water well production and lowers power cost. Safe on rubber and metal. | 58164 | |
| CITRIC ACID - 50 LB - Lowers Ph in a safe manner. Also used to clean boilers. | 43714 | |
| CAUSTIC SODA - 100 LB - Used to raise Ph in a chemical feed application. | 23544 | |
| CAUSTIC SODA - 5 GAL - Used to raise Ph in a chemical feed application. | 50791 | |
| SODA ASH - 50 LB - Mineral used to raise Ph in chemical feed application. | 9300 | |
| SODA SESQUICARBONATE - 100 LB - Finer and cleaner form of Soda Ash. Better dilution for raising Ph in chemical feed application. | 47948 | |
| ALUMINUM SULFATE - 50 lb - Floccula agent used to settle out minerals and organics from solution. | 46833 | |
| IODINE - 3 LB - Disinfection agent that must be used in low dose levels. | 35040 | |

DUFF COMPANY
WE SELL SOLUTIONS!

**CALL US WITH
 YOUR QUESTIONS!
 610-275-4453**

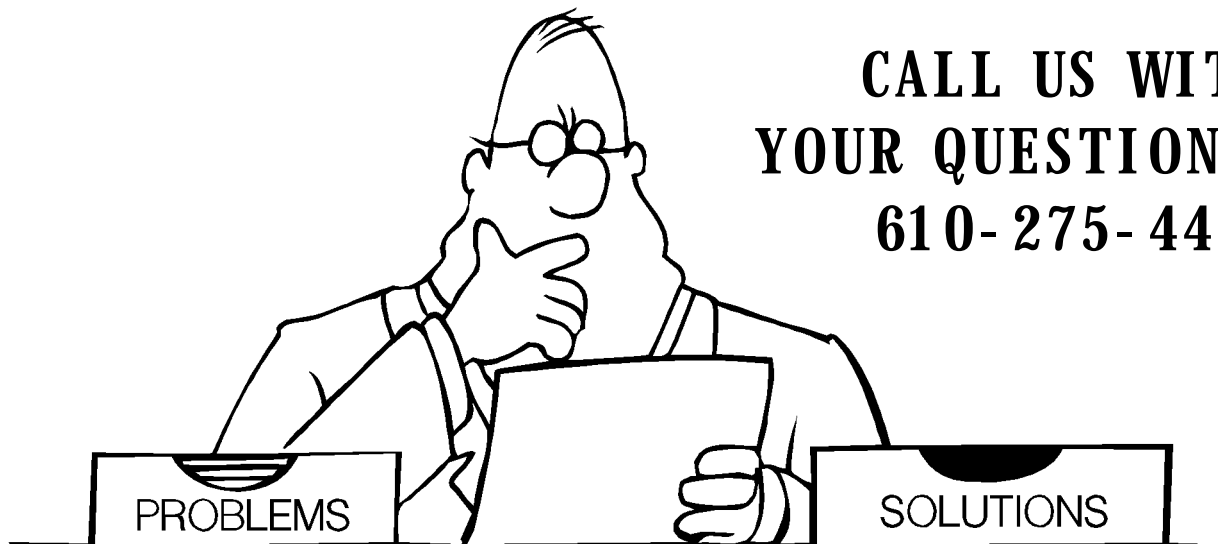

RETENTION TANKS

COMPOSITE STYLE - MANUFACTURED BY STRUCTURAL FIBERS

| FIG. NO. | MODEL NO. | DIAMETER | HEIGHT | WEIGHT (LBS) | PRICE |
|----------|-----------|----------|--------|--------------|-------|
| | CT 30 | 16 | 44 | 25 | |
| | CT 40 SQ | 21 | 35 | 28 | |
| | CT 40 | 16 | 56 | 33 | |
| 47942 | CT80 | 21 | 67 | 43 | |
| 47943 | CT120 | 24 | 73 | 63 | |

Maximum operating pressure = 75 psi

EPOXY COATED STEEL TANKS

| FIG. NO. | MODEL NO. | DIAMETER | HEIGHT | WEIGHT (LBS) | PRICE |
|----------|-----------|----------|--------|--------------|-------|
| | RT30 | 16 | 39 | 32 | |
| 50798 | RT42T | 16 | 53 | 44 | |
| | RT42S | 20 | 36 | 53 | |
| 50799 | RT80 | 20 | 64 | 84 | |
| 50800 | RT120 | 24 | 66 | 139 | |
| | RT220 | 30 | 78 | 295 | |

Maximum operating pressure = 75 psi, TEMP 125°F

GALVANIZED TANKS

| FIG. NO. | MODEL NO. | DIAMETER | HEIGHT | WEIGHT (LBS) | PRICE |
|----------|-----------|----------|--------|--------------|-------|
| 25514 | GT30 | 16 | 39 | 52 | |
| 7854 | GT42T | 16 | 51 | 71 | |
| 7858 | GT42S | 20 | 34 | 71 | |
| 7861 | GT80 | 20 | 64 | 114 | |
| 7864 | GT120 | 24 | 65 | 154 | |
| 23340 | GT220 | 30 | 80 | 303 | |

Maximum Operating Pressure 75 PSI, Temp 140oF. Option: Galvanized tanks can be ordered for 125 PSI.

Typical Installation w/Chemical Feed Pump

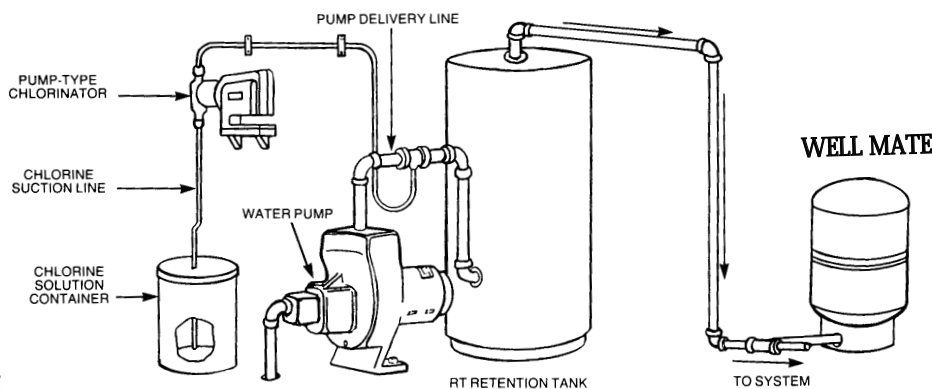

Polyethylene Solution Tanks

Used to hold mixed chemical solutions for chemical feed pumps. The lids feature a convenient feed hole for easy solution replenishment.

| FIG. NO. | SIZE | DIMENSIONS | PRICE |
|----------|--------|-------------|-------|
| 25237 | 15 Gal | 14 x 24 | |
| 39019 | 30 Gal | 18 x 30 | |
| 49219 | 35 Gal | 23 x 26 | |
| 40897 | 40 Gal | 18 x 40 1/2 | |
| 49251 | 55 Gal | 23 x 40 1/2 | |
| 40734 | 75 Gal | 24 x 40 1/2 | |

WELLMATE WATER SYSTEMS

WELLMATES

Composite construction means they are rust proof, won't dent or scratch, half the weight of steel tanks and they meet ANSI/NSF #61 standards for water system components.



| FIG. NO. | MODEL NO. | CAPACITY | MAX OPER PRESSURE PSI | HEIGHT | DIAMETER | WEIGHT/LB | PRICE |
|----------|-----------|----------|-----------------------|--------|----------|-----------|-------|
| 7835 | WM6 | 19.8 | 100 | 32" | 16" | 19 | |
| 7840 | WM9 | 30 | 100 | 44" | 16" | 24 | |
| 7843 | WM12 | 40 | 100 | 57" | 16" | 30 | |
| 45396 | WM25WB | 87 | 125 | 55" | 24" | 70 | |
| 57456 | WM35WB | 120 | 125 | 74" | 24" | 100 | |

WB = Wide Body

ROMATE TANKS

ROMATE

Permeate storage vessels for Reverse Osmosis Water.

| FIG. NO. | MODEL NO. | CAPACITY (GAL) | HEIGHT | DIAMETER | WEIGHT/LB | PRICE |
|----------|-----------|----------------|--------|----------|-----------|-------|
| 47207 | ROMATE4 | 3.6 | 19 3/8 | 9 | 8 | |
| 80141 | ROMATE4E | 3.6 | 19 3/8 | 9 | 8 | |
| 73909 | ROMATE15 | 14.5 | 26 1/2 | 16 | 15 | |
| 45354 | ROMATE20 | 19.8 | 32 | 16 | 19 | |
| 45355 | ROMATE30 | 29.5 | 44 | 16 | 23 | |
| 45356 | ROMATE40 | 40.3 | 56 3/4 | 16 | 30 | |
| 48693 | ROMATE80 | 86.7 | 55 1/2 | 24 1/4 | 58 | |

these non metallic tanks will never chip, rust or dent!

Maximum pressure = 125 PSI



Products for Quality Water

ULTRAVIOLET WATER EQUIPMENT

DWC Ultraviolet water treatment equipment is for germicidal solution, TOC/organic reduction and deo-
zoning. Generally, equipment is manufactured using 304 stainless for potable and light
commercial/industrial markets and 316L for critical industrial and high purity water markets. DWC UV
lights utilize germicidal UV lamps that produce short wave radiation that is lethal to bacteria, viruses and
other micro-organisms present in common water.

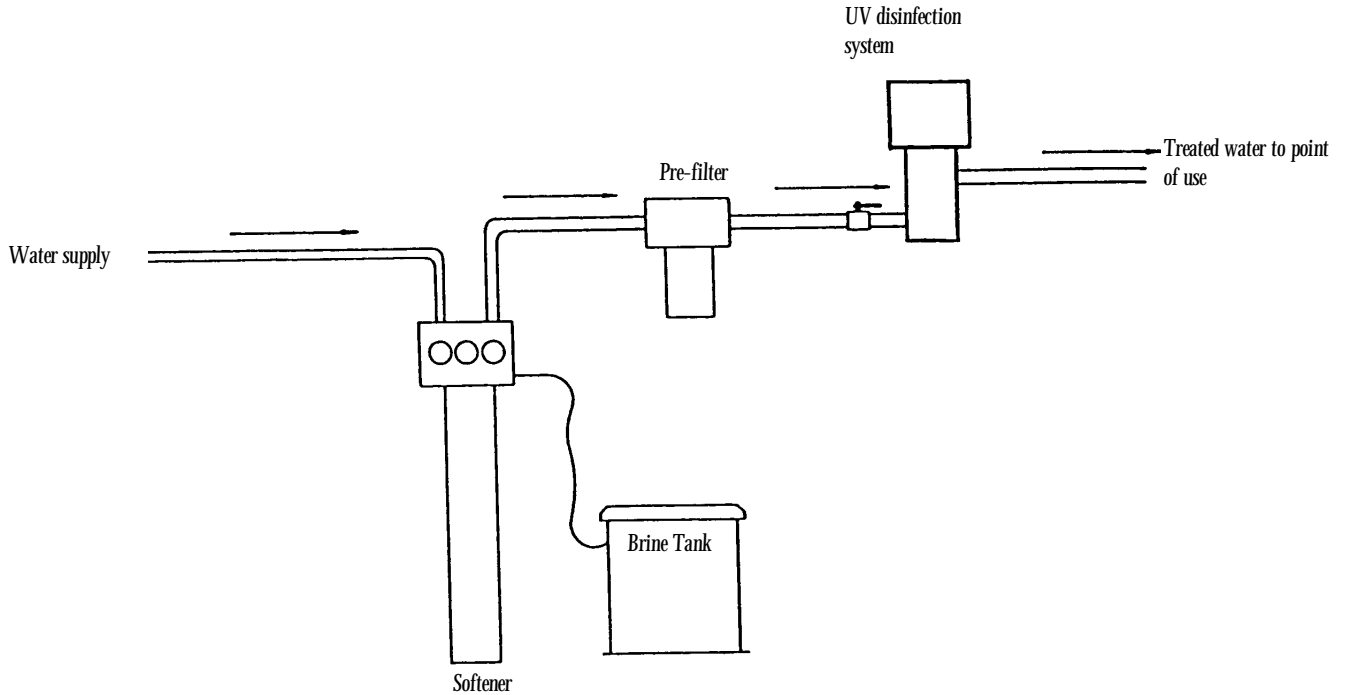

RECOMMENDED MAXIMUM CONCENTRATION LEVELS

BEFORE ULTRAVIOLET INFLUENT
FOR STANDARD APPLICATIONS

| | | |
|------------------|-----------|---------|
| TURBIDITY | 5 NTU | MAXIMUM |
| SUSPENDED SOLIDS | 10 MG/1 | MAXIMUM |
| COLOR | NONE | MAXIMUM |
| IRON | 0.3 MG/1 | MAXIMUM |
| MANGANESE | 0.05 MG/1 | MAXIMUM |
| Ph | 6.5-9.5 | MAXIMUM |

ULTRAVIOLET LIGHTS

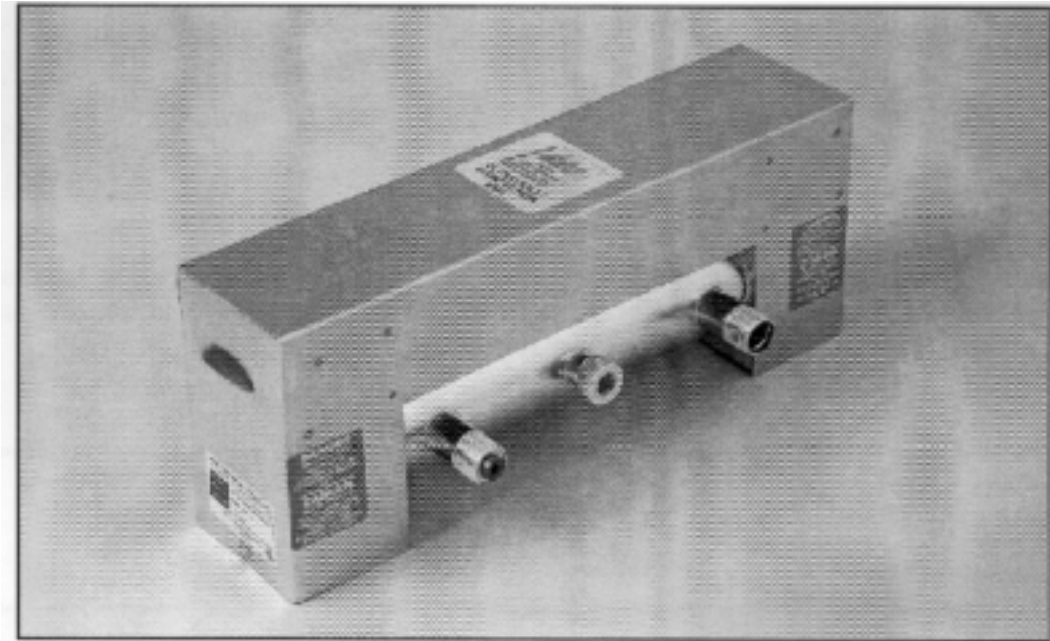

| FIG. NO. | DESCRIPTION | PRICE |
|----------|-------------------------------------|-------|
| 43606 | GUS 7 GPM UV Light | |
| 50814 | GUS 7 GPM UV Light w/ alarm | |
| 69722 | GUS 7 GPM UV Light w/ alarm & wiper | |
| 43607 | GUS 15 GPM UV Light | |
| 50816 | GUS 15 GPM UV Light w/ alarm | |
| 51216 | GUS 20 GPM UV Light | |
| 64805 | GUS 30 GPM UV Light | |
| 66420 | GUS 30 GPM UV Light w/ alarm | |
| 76428 | DWC 1 GPM UV Light | |
| 52339 | DWC 7 GPM UV Light | |
| 52395 | DWC 15 GPM UV Light | |
| | DWC 24 GPM UV Light w/ wiper | |
| 76070 | SL8 8GPM UV Light | |
| 57424 | SV7 GPM UV Light w/ alarm | |
| 57425 | SV10 GPM UV Light w/ alarm | |

Call DUFF COMPANY for the right size UV light to fill your needs promptly.

DUFF COMPANY has the right UV bulb in stock for your requirement regardless of where you purchased your UV light originally!

Simply measure the overall length from tip to tip and tell us how many prongs are on each side.

IMPORTANT - U/V bulbs should be changed a minimum of once each year!!!

Call us for any other requirements like quartz, o-rings, ballasts, etc.

UV LAMPS

| FIG. NO. | DESCRIPTION | OVERALL LENGTH | PRICE |
|----------|-----------------|---|-------|
| 45479 | 1 Pin each end | 14" overall length | |
| 23545 | 1 Pin each end | 17" overall length | |
| 23546 | 1 Pin each end | 27" overall length | |
| 31886 | 1 Pin each end | 33" overall length | |
| 47503 | 1 Pin each end | 45 ⁷ / ₈ " overall length | |
| 51743 | 2 Pins each end | 12" overall length | |
| 41938 | 2 Pins each end | 14" overall length | |
| 50634 | 2 Pins each end | 17" overall length | |
| 43539 | 2 Pins each end | 31" overall length | |
| 47602 | 3 Pins one end | 33" overall length | |
| 48510 | 4 Pins one end | 12" overall length | |
| 41939 | 4 Pins one end | 14" overall length | |
| 50465 | 4 Pins one end | 17" overall length | |
| 63764 | 4 Pins one end | 25" overall length | |
| 47602 | 4 Pins one end | 33" overall length | |

it is helpful to know who the manufacturer of the uv is for absolute accuracy in mactching up bulbs!

QUARTZES FOR UV LAMPS

MANUFACTURER'S NAME REQUIRED

| FIG. NO. | DESCRIPTION | PRICE |
|----------|-----------------|-------|
| 45462 | 14" open ends | |
| 51028 | 15" open ends | |
| 51077 | 16" closed ends | |
| 38953 | 18" open ends | |
| 47760 | 19" closed ends | |
| 25796 | 27" open ends | |
| 63765 | 27" closed ends | |
| 38954 | 33" open ends | |
| 70468 | 35" closed ends | |



REVERSE OSMOSIS

Reverse Osmosis (RO) is one of the most convenient and economical methods of reducing unwanted contaminants in your drinking water. RO is the process by which water molecules are forced, by water pressure, through a semipermeable membrane. Most of the impurities and other contaminants are rinsed to the drain while the refined water is routed to a special holding tank.

Typical installation of reverse osmosis drinking water system

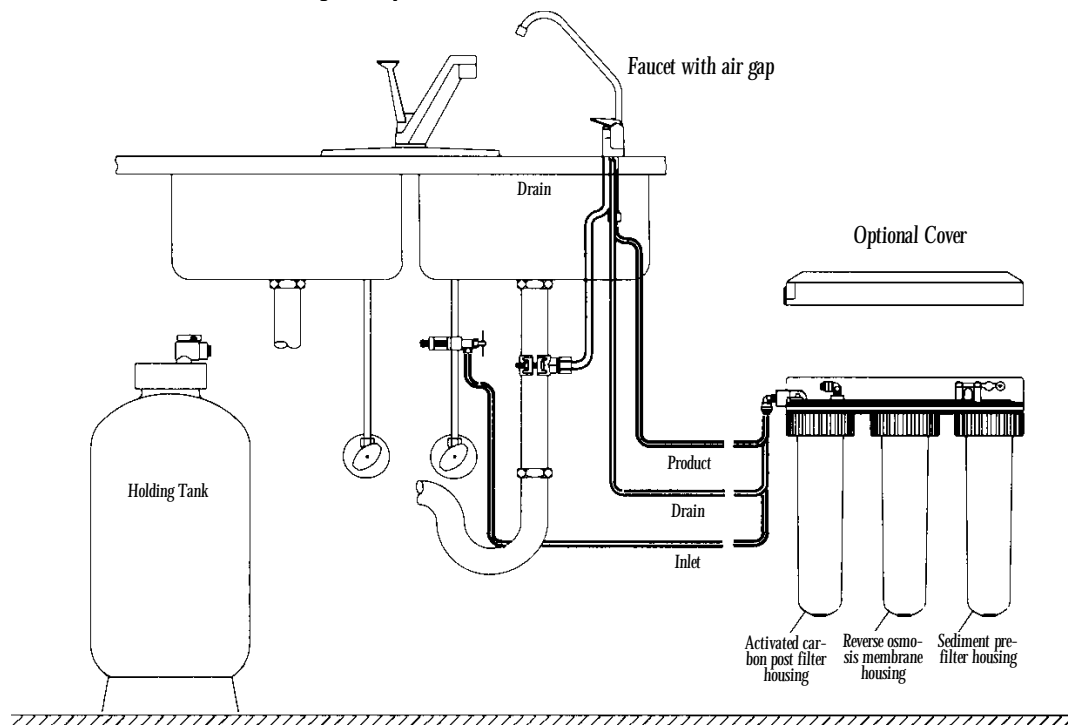

For best results with CTA membrane the following incoming water specifications need to be followed. CTA is Cellulose Triacetate membranes that are chlorine tolerable.

INCOMING WATER SPECIFICATIONS

| | |
|---|--|
| Water Pressure Range | 40-125 psi |
| Maximum Total Dissolved Solids (T.D.S.) | no more than 1500 ppm |
| Water Temperature Range | 40-85°F |
| Allowable pH Range | 5-8.5 |
| Maximum Hardness | no more than 10 grains per gallon or presoften |
| Maximum Iron | no more than 0.1 ppm |
| Maximum Manganese | no more than 0.05 ppm |
| Hydrogen Sulfide Restriction | hydrogen sulfide must not be present |
| Chlorine Level ⁴ | 0.2-2.0 ppm |
| Bacteria Restriction ⁵ | water source must be potable |

COMMERCIAL REVERSE OSMOSIS

REVERSE OSMOSIS SYSTEM SPECIFICATIONS - 1,500 to 6,000 GALLONS PER DAY

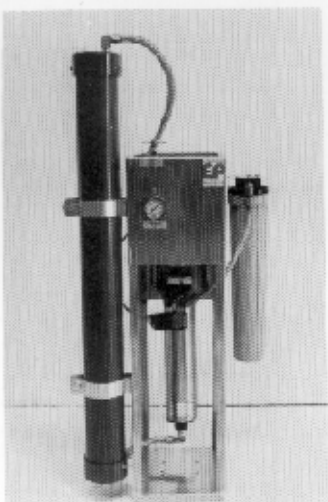

EPRO-1500

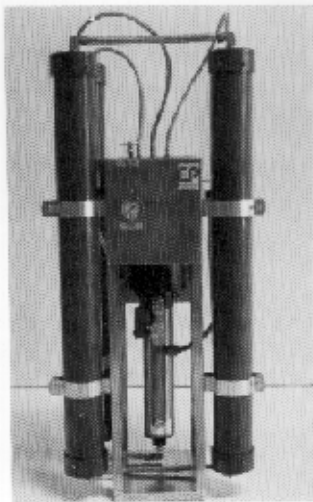

EPRO-4500

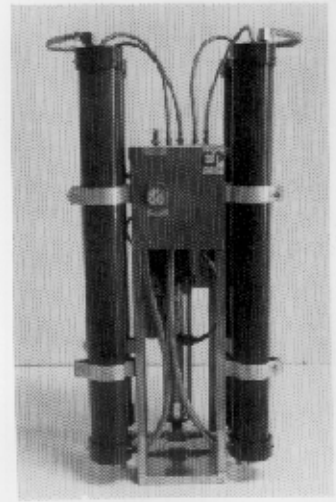

EPRO-6000

| <i>Standard features:</i> | <i>Optional features:</i> | <i>Applications:</i> |
|--|--|---|
| <ul style="list-style-type: none"> - T.F.C. R.O. Membranes - 98% average salt rejection - Expandability from EPRO-1500 to EPRO-3000 or from EPRO-4500 to EPRO-6000 - 5 micron sediment prefilter - Stainless Steel tubing - Centrifugal booster pump | <ul style="list-style-type: none"> - Low pressure shut-off switch - Product water flow meter - Waste water flow meter - Waste recycle valve - Waste recycle flow meter - Stainless Steel pump - 50 Hz/220V motor - Prefilter pressure gauges - Repressurization system - Storage tank - UV sterilizer - TDS monitor - Brackish water membranes - Fiberglass housings - High-Efficiency Model with High-Flow Membranes | <ul style="list-style-type: none"> - Households - Restaurants - Carwashes - Bottled water - Hospitals - Pretreatment for D.I. - Plant nurseries - Fisheries - Printing Processes - Ice Machines |

SYSTEM SPECIFICATIONS

| FIG. NO. | PRODUCTION * | | OPERATING PRESSURE 3rd YEAR (psi) | | DIMENSIONS (in/cm) | | | WEIGHT (lb/kg) | INLET (MPT) | NO. 4" x 40" ELEMENTS | DESIGNED RECOVERY % | MOTOR HP (1-phase) | | | |
|-----------|--------------|-------|-----------------------------------|-----------------|--------------------|--------|-------|----------------|-----------------|-----------------------|---------------------|--------------------|-----|------------|-----|
| | | | | | | | | | | | | 60 Hz 230V | | 50 Hz 220V | |
| | GPD | LPD | Standard Model | High-Efficiency | Height | Length | Width | Standard Model | High-Efficiency | Standard Model | High-Efficiency | | | | |
| 60020 | 1500 | 5680 | 202 | 114 | 50/127 | 24/61 | 24/61 | 95/43 | 3/4" | 1 | 19 | 1.5 | 1/2 | 1 | 1 |
| EPRO-3000 | 3000 | 11360 | 207 | 117 | 50/127 | 24/61 | 24/61 | 120/55 | 3/4" | 2 | 32 | 1.5 | 3/4 | 1 | 1 |
| EPRO-4500 | 4500 | 17035 | 213 | 120 | 50/127 | 24/61 | 24/61 | 150/68 | 3/4" | 3 | 40 | 3 | 3/4 | 3 | 1.5 |
| EPRO-6000 | 6000 | 22715 | 219 | 124 | 50/127 | 24/61 | 24/61 | 180/82 | 3/4" | 4 | 50 | 3 | 3/4 | 3 | 1.5 |

* Based on 24 hour operation, feed TDS of 600 mg/L and temperature of 25°C

THIS WILL PROVIDE THE FOLLOWING RESULTS...

MICROLINE® C.T.A.-14S PERFORMANCE SPECIFICATIONS

| Membrane Rating | |
|--|---------------------------------|
| Membrane Production ¹ | produces 14 ± 2 gallons per day |
| Membrane T.D.S. Reduction ¹ | 90% minimum |
| System Rating | |
| Warm Climate Production ² | produces 9½ ± 2 gallons per day |
| Warm Climate T.D.S. Reduction ² | 85%+ typical |
| Cold Climate Production ³ | produces 6 ± 1 gallons per day |
| Cold Climate T.D.S. Reduction ³ | 85%+ typical |

1 Measured at Industry Standard condition of 60 psi, 77°F, 500 ppm T.D.S., and discharging to atmosphere.

2 Actual capacity measured at 55 psi, 77° F, and 750 ppm T.D.S. per Industry Standard S-300-91.

3 Actual capacity measured at 50 psi, 50°F, and 325 ppm T.D.S.

4 Chlorinated feed water is necessary for membrane protection.

5 Do not use this system where the feed water is microbiologically unsafe or with water of unknown quality without adequate disinfection before or after the unit.

| FIG. NO. | DESCR | GPD | STAGE | PRICE |
|----------|------------|-------------------|-------|-------|
| 25230 | DWC CTA RO | 14 Gallon Per day | 3 | |
| 45076 | DWC CTA RO | 14 Gallon Per day | 4 | |

TFC or Thin Film Composite membranes are not chlorine tolerant but do prevent bacteria infusions. The following are applicable for TFC membrane RO's.

MICROLINE® T.F.C.-25D/25DN PERFORMANCE SPECIFICATIONS

| Membrane Rating | |
|--|---------------------------------|
| Membrane Production ¹ | produces 25 ± 5 gallons per day |
| Membrane T.D.S. Reduction ¹ | 95% minimum |
| System Rating | |
| Warm Climate Production ² | produces 16 ± 4 gallons per day |
| Warm Climate T.D.S. Reduction ² | 90%+ typical |
| Cold Climate Production ³ | produces 9 ± 2 gallons per day |
| Cold Climate T.D.S. Reduction ³ | 90%+ typical |

INCOMING WATER SPECIFICATIONS

| | |
|---|--|
| Water Pressure Range | 40-125 psi |
| Maximum Total Dissolved Solids (T.D.S.) | no more than 2000 ppm |
| Water Temperature Range | 40-110°F |
| Allowable pH Range | 5-10 |
| Maximum Hardness | no more than 10 grains per gallon or presoften |
| Maximum Iron | no more than 0.1 ppm |
| Maximum Manganese | no more than 0.05 ppm |
| Hydrogen Sulfide Restriction | hydrogen sulfide must not be present |
| Chlorine Restriction ⁴ | chlorine must not be present |
| Bacteria Restriction ⁵ | water source must be potable |

1 Measured at Industry Standard condition of 60 psi, 77°F, 500 ppm T.D.S., and discharging to atmosphere.

2 Actual capacity measured at 55 psi, 77° F, and 750 ppm T.D.S. per Industry Standard S-300-91.

3 Actual capacity measured at 50 psi, 50°F, and 325 ppm T.D.S.

4 Chlorine will damage a T.F.C. Membrane. The Sediment/Carbon Prefilter Cartridge will remove chlorine from the incoming water. Change cartridge every 6 months, more often if the water contains more than 1 ppm chlorine.

5 Do not use these systems where the feed water is microbiologically unsafe or with water of unknown quality without adequate disinfection before or after the unit.

| FIG. NO. | DESCRIPTION | GPD | STAGE | PRICE |
|----------|-------------|--------|-------|-------|
| 49113 | DWCTFC25S | 25 GPD | 3 | |
| 45616 | DWCTFC25D | 25 GPD | 4 | |

QEST

DWC PRESENTS QEST- A TOTAL POLYBUTYLENE SYSTEM FOR THE PROFESSIONAL PLUMBER AND WATER TREATMENT DEALER.

QEST offers the professional plumber a practical hot/cold pressure plumbing system for every kind of job...new construction...remodeling...and repair. You can rely on practical QEST systems because they were developed to meet the needs of the plumbing professional. Each system has been thoroughly tested and time proven, and they meet national standards, agency approvals and many state and local codes. The key work for QEST systems is "efficiency". One man can easily carry a 1000' roll of 1/2" polybutylene tubing (47 pounds). And because polybutylene is flexible at all temperatures, it can be installed in long lengths with a minimum number of joints and elbows.

Here are just a few additional advantages offered by QEST systems.

TROUBLE FREE POLYBUTYLENE

Corrosion resistant-no electrolysis-freeze damage tolerant

CRIMP AND THREAD CONNECTIONS

No exotic parts to fail-no solvents, bonding agents or "glues" used

No solder, flux or gas used-more positive connections, quicker, easier.

LOW HEAT CONDUCTIVITY

Low temperature loss: hot stays hot, cold stays cold

ELIMINATES MOST WATER HAMMER CONDITIONS

| FIG. NO. | DESCRIPTION | PRICE |
|----------|--------------------------------|-------|
| 41072 | 1/2"X100' COIL QEST PIPE | |
| 41073 | 3/4"X100' COIL QEST PIPE | |
| 50231 | 1/2"X20' COIL QEST PIPE | |
| 44652 | 3/4"X10' COIL QEST PIPE | |
| 50232 | 3/4"X20' QEST PIPE | |
| 41074 | 1/2" TEE | |
| 43325 | 1/2"X3/4" TEE | |
| 43327 | 3/4"X1/2"X1/2" TEE | |
| 41091 | 3/4"X1/2"X3/4" TEE | |
| 41076 | 3/4"X1/2" TEE | |
| 41075 | 3/4" TEE | |
| 41077 | 1/2" 90 | |
| 43333 | 3/4"X1/2" 90 | |
| 41078 | 3/4" 90 | |
| 43335 | 1/2" MALE 90 | |
| 43337 | 3/4" MALE 90 | |
| 41079 | 1/2" COUPLING | |
| 41081 | 3/4"X1/2" COUPLING | |
| 41080 | 3/4" COUPLING | |
| 41085 | 1/2" FEMALE ADAPTER | |
| 41086 | 3/4" FEMALE ADAPTER | |
| 41083 | 1/2" MALE ADAPTER | |
| 41084 | 3/4" MALE ADAPTER | |
| 43345 | 1/2" COP MALE X QEST ADAPTER | |
| 43346 | 3/4" CP MALE X QEST ADAPTER | |
| 43347 | 1/2" COP FEMALE X QEST ADAPTER | |
| 43348 | 3/4" COP FEMALE X QEST ADAPTER | |
| 41094 | 1/2" CRIMP RING | |
| 41095 | 3/4" CRIMP RING | |
| 43351 | 1/2 CRIMP TOOL | |
| 43350 | 3/4" CRIMP TOOL | |
| 44654 | 1/2" J-HOOK | |
| 44655 | 3/4" J-HOOK | |

JOHN GUEST FITTINGS

**SUPER SPEEDFIT...
FAST, RELIABLE TUBING CONNECTIONS
WITH NO TOOLS!**

This simple concept, pioneered by John Guest over 20 years ago, now embodies a comprehensive line of over 3,000 products addressing virtually every tubing-connection requirement. From the Food Service Industry to the movement of compressed air, John Guest Super Speedfit push-in fittings afford the most efficient and cost effective solution in tubing connections.

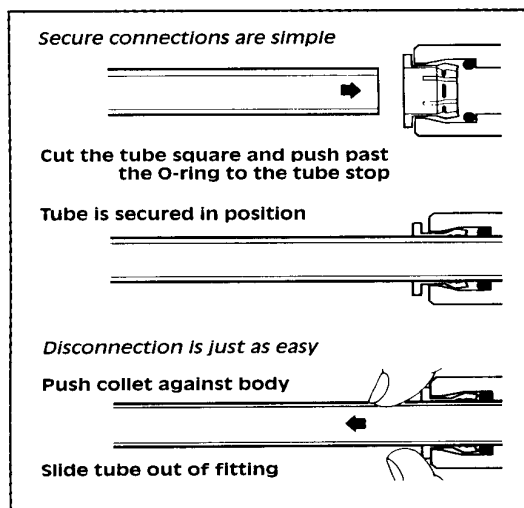

SUPER SPEEDFIT FITTINGS MAKE SECURE CONNECTIONS SIMPLE

In all applications, JG Super Speedfit fittings require no tools. Tubing is simply inserted into the fitting collet to effect a secure connection. Whether metal or plastic tubing is used, the integrity of the connection is assured - John Guest fittings are manufactured to the strictest tolerances. Our production processes employ statistical process control to ensure the absence of variation. Our designs provide superior flow characteristics and eliminate the need for sealants. Moreover, our fittings can be reused repeatedly without the loss of connection integrity.

POLYETHYLENE TUBING

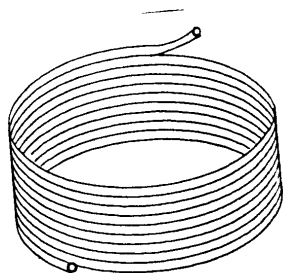

| SIZE | COIL SIZE | FIG. NO. | PRICE |
|------|-----------|----------|-------|
| 1/4 | 100 | 17713 | |
| 1/4 | 1000 | 48750 | |
| 5/16 | 100 | 17714 | |
| 3/8 | 100 | 17715 | |
| 3/8 | 1000 | 51797 | |
| 1/2 | 100 | 17716 | |
| 5/8 | 100 | 17718 | |
| 5/8 | 500 | 48749 | |
| 3/4 | 100 | 44589 | |

JOHN GUEST FITTINGS
UNION CONNECTOR



MALE ADAPTER

| FIG. NO. | TUBE O.D. | PIPE THREAD | PRICE |
|----------|-----------|-------------|-------|
| 82249 | 1/4 | 1/8 | |
| 82251 | 1/4 | 1/4 | |
| 82252 | 1/4 | 3/8 | |
| 82253 | 3/8 | 1/4 | |
| 82254 | 3/8 | 3/8 | |
| 82255 | 3/8 | 1/2 | |
| 82256 | 1/2 | 3/8 | |
| 82257 | 1/2 | 1/2 | |

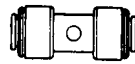

| FIG. NO. | TUBE O.D. | PIPE THREAD |
|----------|-----------|-------------|
| 82264 | 1/4 | |
| 82265 | 3/8 | |
| 82266 | 1/2 | |
| 83770 | 3/8x5/16 | |
| 82275 | 3/8x1/4 | |
| 82276 | 1/2x3/8 | |

STEM ADAPTER



| FIG. NO. | TUBE O.D. | PIPE THREAD | PRICE |
|----------|-----------|-------------|-------|
| 82267 | 1/4 | 1/4 | |
| 82268 | 3/8 | 1/4 | |
| 82269 | 3/8 | 3/8 | |

FIXED ELBOW

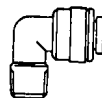

| FIG. NO. | TUBE O.D. | PIPE THREAD | PRICE |
|----------|-----------|-------------|-------|
| 82284 | 1/4 | 1/4 | |
| 82285 | 1/4 | 3/8 | |
| 82286 | 3/8 | 1/4 | |
| 82287 | 3/8 | 3/8 | |

UNION TEE

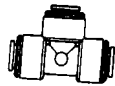

| FIG. NO. | TUBE O.D. | PIPE THREAD |
|----------|-----------|-------------|
| 82258 | 1/4 | |
| 83769 | 5/16 | |
| 82259 | 3/8 | |
| 82260 | 1/2 | |

UNION ELBOW



| FIG. NO. | TUBE O.D. | PIPE THREAD |
|----------|-----------|-------------|
| 82261 | 1/4 | |
| 82262 | 3/8 | |
| 82263 | 1/2 | |
| 82277 | 3/8x1/4 | |

SHUT OFF VALVES

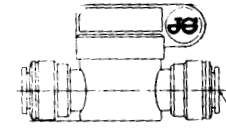

1/4" straight speedfit

| FIG. NO. | PRICE |
|----------|-------|
| 82291 | |

1/4" straight speedfit x 1/4 MPT

| FIG. NO. | PRICE |
|----------|-------|
| 82289 | |

1/4" angle speedfit x 1/4 FPT

| FIG. NO. | PRICE |
|----------|-------|
| 82295 | |

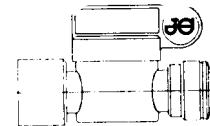

3/8" straight speedfit

| FIG. NO. | PRICE |
|----------|-------|
| 82292 | |

3/8" straight speedfit x 3/8 mpt

| FIG. NO. | PRICE |
|----------|-------|
| 82290 | |

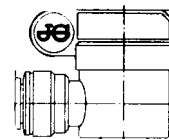

3/8 angle speedfit x 3/8 FPT

| FIG. NO. | PRICE |
|----------|-------|
| 82296 | |

MISCELLANEOUS

| DESCRIPTION | FIG. NO. | PRICE |
|-----------------------------|----------|-------|
| 1/4" Poly tube Blue/ft. | 82408 | |
| 3/8" Poly tube Blue/ft. | 82411 | |
| 1/4" locking clips | 82297 | |
| 3/8" locking clips | 82298 | |
| Tubing cutter | 82299 | |
| Release tool set | 82300 | |
| 3/8x1/2 Stem X Hose Adapter | 83772 | |

NYLON COMPRESSION FITTINGS

MALE CONNECTORS



| FIG. NO. | TUBE O.D. | PIPE THRD | PRICE |
|----------|-----------|-----------|-------|
| 3559 | 1/8 | 1/8 | |
| 3564 | 1/4 | 1/8 | |
| 3565 | 1/4 | 1/4 | |
| 3567 | 1/4 | 3/8 | |
| 47104 | 5/16 | 1/8 | |
| 3569 | 5/16 | 1/4 | |
| 22282 | 3/8 | 1/8 | |
| 3570 | 3/8 | 1/4 | |
| 3571 | 3/8 | 3/8 | |
| 47105 | 3/8 | 1/2 | |
| 29583 | 1/2 | 1/8 | |
| 29584 | 1/2 | 1/4 | |
| 3572 | 1/2 | 3/8 | |
| 3575 | 1/2 | 1/2 | |
| 24097 | 5/8 | 3/8 | |
| 3576 | 5/8 | 1/2 | |
| 3577 | 3/4 | 1/2 | |
| 29585 | 3/4 | 3/4 | |
| 47106 | 7/8 | 3/4 | |

FEMALE CONNECTORS



| FIG. NO. | TUBE O.D. | PIPE THRD | PRICE |
|----------|-----------|-----------|-------|
| 29617 | 1/4 | 1/8 | |
| 29618 | 1/4 | 1/4 | |
| 29619 | 5/16 | 1/4 | |
| 29620 | 3/8 | 1/4 | |
| 29621 | 3/8 | 3/8 | |
| 29622 | 1/2 | 3/8 | |
| 29624 | 1/2 | 1/2 | |
| 29625 | 5/8 | 1/2 | |

MALE ELBOWS

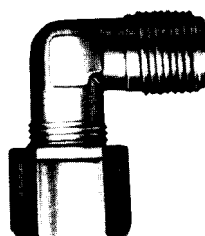

| FIG. NO. | TUBE O.D. | PIPE THRD | PRICE |
|----------|-----------|-----------|-------|
| 3589 | 1/8 | 1/8 | |
| 42455 | 1/4 | 1/8 | |
| 3590 | 1/4 | 1/4 | |
| 3592 | 1/4 | 3/8 | |
| 3593 | 5/16 | 1/4 | |
| 3596 | 3/8 | 1/4 | |
| 3599 | 3/8 | 3/8 | |
| 3600 | 1/2 | 3/8 | |
| 3604 | 1/2 | 1/2 | |
| 48970 | 5/8 | 3/8 | |
| 3606 | 5/8 | 1/2 | |

UNION & REDUCING UNION CONNECTORS

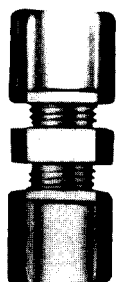

| FIG. NO. | TUBE O.D. | PRICE |
|----------|-----------|-------|
| 3579 | 1/4 | |
| 29587 | 5/16 | |
| 3581 | 3/8 | |
| 3583 | 1/2 | |
| 3585 | 5/8 | |
| 3587 | 3/4 | |
| 29586 | 1/4-1/8 | |
| 29588 | 5/16-1/4 | |
| 29589 | 3/8-1/4 | |
| 29590 | 1/2-3/8 | |

FEMALE ELBOWS

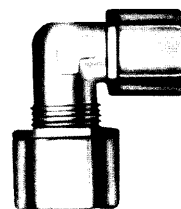

| FIG. NO. | TUBE O.D. | PIPE THRD | PRICE |
|----------|-----------|-----------|-------|
| 29602 | 1/8 | 1/4 | |
| 29603 | 1/4 | 1/8 | |
| 29604 | 1/4 | 1/4 | |
| 29605 | 5/16 | 1/4 | |
| 29606 | 3/8 | 1/4 | |
| 29608 | 3/8 | 3/8 | |
| 29609 | 1/2 | 3/8 | |
| 29610 | 1/2 | 1/2 | |
| 29611 | 5/8 | 1/2 | |

BULK HEAD UNIONS

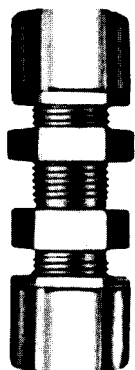

| FIG. NO. | TUBE O.D. | PRICE |
|----------|-----------|-------|
| 29612 | 1/4 | |
| 29613 | 5/16 | |
| 29614 | 3/8 | |
| 29615 | 1/2 | |
| 29616 | 3/4 | |

UNION ELBOWS

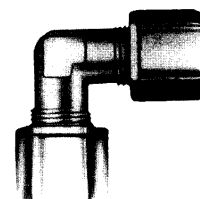

| FIG. NO. | TUBE O.D. | PRICE |
|----------|-----------|-------|
| 3609 | 1/4 | |
| 29591 | 5/16 | |
| 3611 | 3/8 | |
| 3612 | 1/2 | |
| 3614 | 5/8 | |

NYLON COMPRESSION FITTINGS

MALE BRANCH TEES

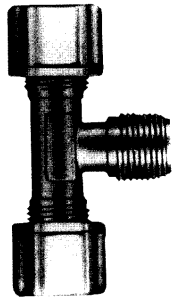

| FIG. NO. | TUBE O.D. | PIPE THRD | PRICE |
|----------|-----------|-----------|-------|
| 17463 | 1/4 | 1/8 | |
| 3616 | 1/4 | 1/4 | |
| 29592 | 5/16 | 1/4 | |
| 3617 | 3/8 | 1/4 | |
| 3619 | 3/8 | 3/8 | |
| 3621 | 1/2 | 3/8 | |
| 3622 | 1/2 | 1/2 | |
| 3623 | 5/8 | 1/2 | |

UNION TEES

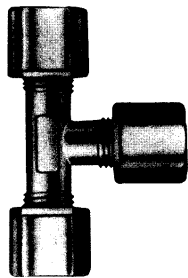

| FIG. NO. | TUBE O.D. | PRICE |
|----------|-----------|-------|
| 3626 | 1/8 | |
| 3628 | 1/4 | |
| 3630 | 5/16 | |
| 3631 | 3/8 | |
| 3635 | 1/2 | |
| 3638 | 5/8 | |
| 29593 | 5/8-3/8 | |

MALE RUN TEES

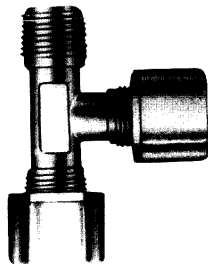

| FIG. NO. | TUBE O.D. | PIPE THRD | PRICE |
|----------|-----------|-----------|-------|
| 29594 | 1/4 | 1/8 | |
| 29595 | 1/4 | 1/4 | |
| 29596 | 5/16 | 1/4 | |
| 29597 | 3/8 | 1/4 | |
| 29598 | 3/8 | 3/8 | |
| 29599 | 1/2 | 3/8 | |
| 29600 | 1/2 | 1/2 | |
| 29601 | 5/8 | 1/2 | |

INSERT



| FIG. NO. | TUBE O.D. | PRICE |
|----------|-----------|-------|
| 3675 | 1/4 | |
| 3678 | 5/16 | |
| 3682 | 3/8 | |
| 3685 | 1/2 | |



JACO

The AIRaider for Radon and VOC Removal

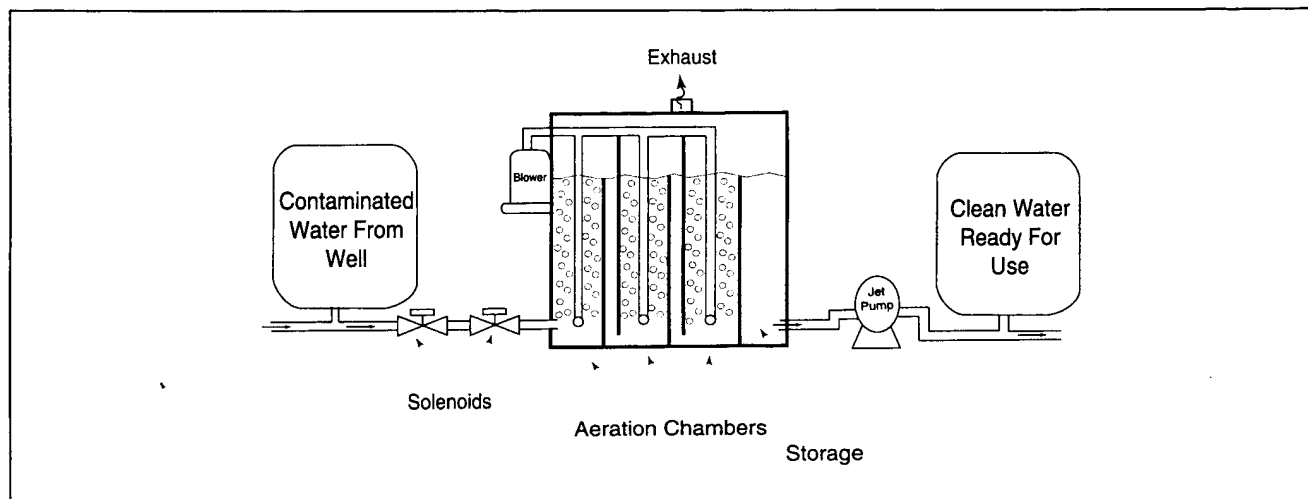

The patented AIRaider™ systems use the patented Cascade Rinse™ process to introduce the contaminated water in a predetermined fashion that maximizes air to water contact. High pressure filtered air is propelled through special anti-fouling diffusers that equally distribute the air in each of the treatment chambers. This process separates the radon and VOC's from the water. The cleaned water awaits repressurization in a built-in storage tank. The gases released from this process are vented safely to the outside air through a 2" vent line.

AIRaider 433 Radon Reduction

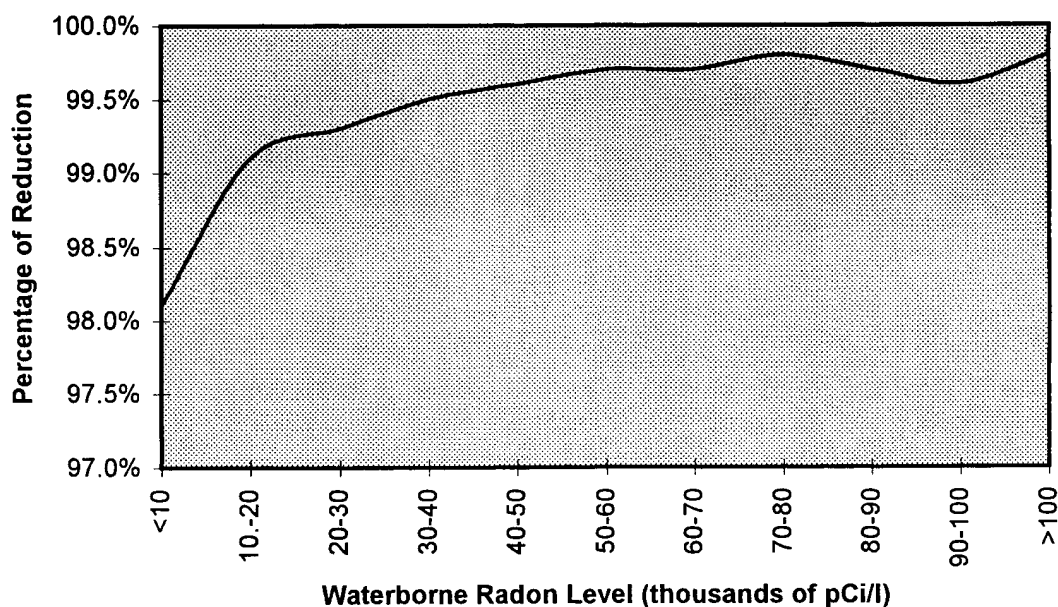

AIRraider™ System Specifications

| System Component | AIRraider™ 312 | AIRraider™ 433 |
|---|---|---|
| Aeration Tank Size | 18.5"W x 16.5"L x 29.5"H (22 gallons) | 18.5"W x 30"L x 32"H (44 gallons) |
| Standard Pressure Tank Size (Well-X-Trol WX202) | 18" diameter (22 gal. / 7 gal. draw down) | 18" diameter (22 gal. / 7 gal. draw down) |
| Total Footprint | 18.5"W x 33"L | 18.5"W x 54"L |
| Total Weight | 150 lbs. | 195 lbs. |
| Aeration Tank Material | FDA approved polypropylene | FDA approved polypropylene |
| Jet Pump | 1/2 hp, 115V / 10.8 amp or 230V / 5.4 amp | 1/2 hp, 115V / 10.8 amp or 230V / 5.4 amp |
| Regenerative Blower | 1/8 hp, 115V / 2.0 amp or 230V / 1.0 amp | 1/2 hp, 115V / 5.6 amp or 230V / 2.8 amp |
| Control Panel | UL listed, 115V or 230V | UL listed, 115V or 230V |
| Vent Line (not included) | 2" Schedule 40 PVC | 2" Schedule 40 PVC |
| Plumbing | 3/4" | 3/4" or 1" |
| Flow Rate | 7 gpm recommended | 7 gpm normal, up to 20 gpm possible* |
| Radon and VOC Reduction | up to 90 - 95+% | up to 99+% |

* Larger jet pump may be needed to achieve 13-20 gpm outflow.

AIRraider™ System Selection

| Site Specifications | | AIRraider™ 312 | AIRraider™ 433 |
|---------------------|------------------|-------------------------------------|-------------------------------------|
| Plumbing Pipe Size | 3/4" | <input checked="" type="checkbox"/> | <input checked="" type="checkbox"/> |
| | 1" | | <input checked="" type="checkbox"/> |
| | 1-1/4" or larger | | Special Order* |
| Flow Rate (GPM) | 7 or less | <input checked="" type="checkbox"/> | <input checked="" type="checkbox"/> |
| | 7-13 | | <input checked="" type="checkbox"/> |
| | 13 or more | | Special Order* |
| Radon Level (pCi/l) | < 35,000 | <input checked="" type="checkbox"/> | <input checked="" type="checkbox"/> |
| | > 35,000 | | <input checked="" type="checkbox"/> |
| | > 250,000 | | Call For Order Info** |

* System will require a larger jet pump and/or holding tank. Call **DUFF COMPANY** for details.

** Levels exceeding 250,000 pCi/l may require special considerations. Call **DUFF COMPANY** for information.

| FIG. NO. | AIRADER MODEL | DESCR | PRICE |
|----------|---------------|--------------------|-------|
| 72805 | 312 | LESS PUMP | |
| 66331 | 312 | WITH PUMP & TANK | |
| 72806 | 312 | W/ GRUNDFOS JETPAK | |
| 72804 | 433 | LESS PUMP | |
| 72793 | 433 | WITH PUMP & TANK | |
| 69158 | 433 | W/ GRUNDFOS JETPAK | |

For additional information call: 610-275-4453 or Fax: 610-279-6299
Please call for current prices.

TEMPERATURE CONVERSION TABLE

| 0 to 100 | | | | 100 to 1000 | | | | | | | |
|----------|-----------|-------|------|-------------|-------|-----|------------|-----|-----|-------------|------|
| C. | F. | C. | F. | C. | F. | C. | F. | | | | |
| -17.8 | 0 | 32.0 | 10.0 | 50 | 122.0 | 38 | 100 | 212 | 260 | 500 | 932 |
| -17.2 | 1 | 33.8 | 10.6 | 51 | 123.8 | 43 | 110 | 230 | 266 | 510 | 950 |
| -16.7 | 2 | 35.6 | 11.1 | 52 | 125.6 | 49 | 120 | 248 | 271 | 520 | 968 |
| -16.1 | 3 | 37.4 | 11.7 | 53 | 127.4 | 54 | 130 | 266 | 277 | 530 | 986 |
| -15.6 | 4 | 39.2 | 12.2 | 54 | 129.2 | 60 | 140 | 284 | 282 | 540 | 1004 |
| -15.0 | 5 | 41.0 | 12.8 | 55 | 131.0 | 66 | 150 | 302 | 288 | 550 | 1022 |
| -14.4 | 6 | 42.8 | 13.3 | 56 | 132.8 | 71 | 160 | 320 | 293 | 560 | 1040 |
| -13.9 | 7 | 44.6 | 13.9 | 57 | 134.6 | 77 | 170 | 338 | 299 | 570 | 1058 |
| -13.3 | 8 | 46.4 | 14.4 | 58 | 136.4 | 82 | 180 | 356 | 304 | 580 | 1076 |
| -12.8 | 9 | 48.2 | 15.0 | 59 | 138.2 | 88 | 190 | 374 | 310 | 590 | 1094 |
| -12.2 | 10 | 50.0 | 15.6 | 60 | 140.0 | 93 | 200 | 392 | 316 | 600 | 1112 |
| -11.7 | 11 | 51.8 | 16.1 | 61 | 141.8 | 99 | 210 | 410 | 321 | 610 | 1130 |
| -11.1 | 12 | 53.6 | 16.7 | 62 | 143.6 | 100 | 212 | 413 | 327 | 620 | 1148 |
| -10.6 | 13 | 55.4 | 17.2 | 63 | 145.4 | 104 | 220 | 428 | 332 | 630 | 1166 |
| -10.0 | 14 | 57.2 | 17.8 | 64 | 147.2 | 110 | 230 | 446 | 338 | 640 | 1184 |
| - 9.44 | 15 | 59.0 | 18.3 | 65 | 149.0 | 116 | 240 | 464 | 343 | 650 | 1202 |
| - 8.89 | 16 | 60.8 | 18.9 | 66 | 150.8 | 121 | 250 | 482 | 349 | 660 | 1220 |
| - 8.33 | 17 | 62.6 | 19.4 | 67 | 152.6 | 127 | 260 | 500 | 354 | 670 | 1238 |
| - 7.78 | 18 | 64.4 | 20.0 | 68 | 154.4 | 132 | 270 | 518 | 360 | 680 | 1256 |
| - 7.22 | 19 | 66.2 | 20.6 | 69 | 156.2 | 138 | 280 | 536 | 366 | 690 | 1274 |
| - 6.67 | 20 | 68.0 | 21.1 | 70 | 158.0 | 143 | 290 | 554 | 371 | 700 | 1292 |
| - 6.11 | 21 | 69.8 | 21.7 | 71 | 159.8 | 149 | 300 | 572 | 377 | 710 | 1310 |
| - 5.56 | 22 | 71.6 | 22.2 | 72 | 161.6 | 154 | 310 | 590 | 382 | 720 | 1328 |
| - 5.00 | 23 | 73.4 | 22.8 | 73 | 163.4 | 160 | 320 | 608 | 388 | 730 | 1346 |
| - 4.44 | 24 | 75.2 | 23.3 | 74 | 165.2 | 166 | 330 | 626 | 393 | 740 | 1364 |
| - 3.89 | 25 | 77.0 | 23.9 | 75 | 167.0 | 171 | 340 | 644 | 399 | 750 | 1382 |
| - 3.33 | 26 | 78.8 | 24.4 | 76 | 168.8 | 177 | 350 | 662 | 404 | 760 | 1400 |
| - 2.78 | 27 | 80.6 | 25.0 | 77 | 170.6 | 182 | 360 | 680 | 410 | 770 | 1418 |
| - 2.22 | 28 | 82.4 | 25.6 | 78 | 172.4 | 188 | 370 | 698 | 416 | 780 | 1436 |
| - 1.67 | 29 | 84.2 | 26.1 | 79 | 174.2 | 193 | 380 | 716 | 421 | 790 | 1454 |
| - 1.11 | 30 | 86.0 | 26.7 | 80 | 176.0 | 199 | 390 | 734 | 427 | 800 | 1472 |
| - 0.56 | 31 | 87.8 | 27.2 | 81 | 177.8 | 204 | 400 | 752 | 432 | 810 | 1490 |
| 0 | 32 | 89.6 | 27.8 | 82 | 179.6 | 210 | 410 | 770 | 438 | 820 | 1508 |
| 0.56 | 33 | 91.4 | 28.3 | 83 | 181.4 | 216 | 420 | 788 | 443 | 830 | 1526 |
| 1.11 | 34 | 93.2 | 28.9 | 84 | 183.2 | 221 | 430 | 806 | 449 | 840 | 1544 |
| 1.67 | 35 | 95.0 | 29.4 | 85 | 185.0 | 227 | 440 | 824 | 454 | 850 | 1562 |
| 2.22 | 36 | 96.8 | 30.0 | 86 | 186.8 | 232 | 450 | 842 | 460 | 860 | 1580 |
| 2.78 | 37 | 98.6 | 30.6 | 87 | 188.6 | 238 | 460 | 860 | 466 | 870 | 1598 |
| 3.33 | 38 | 100.4 | 31.1 | 88 | 190.4 | 243 | 470 | 878 | 471 | 880 | 1616 |
| 3.89 | 39 | 102.2 | 31.7 | 89 | 192.2 | 249 | 480 | 896 | 477 | 890 | 1634 |
| 4.44 | 40 | 104.0 | 32.2 | 90 | 194.0 | 254 | 490 | 914 | 482 | 900 | 1652 |
| 5.00 | 41 | 105.8 | 32.8 | 91 | 195.8 | | | | 488 | 910 | 1670 |
| 5.56 | 42 | 107.6 | 33.3 | 92 | 197.6 | | | | 493 | 920 | 1688 |
| 6.11 | 43 | 109.4 | 33.9 | 93 | 199.4 | | | | 499 | 930 | 1706 |
| 6.67 | 44 | 111.2 | 34.4 | 94 | 201.2 | | | | 504 | 940 | 1724 |
| 7.22 | 45 | 113.0 | 35.0 | 95 | 203.0 | | | | 510 | 950 | 1742 |
| 7.78 | 46 | 114.8 | 35.6 | 96 | 204.8 | | | | 516 | 960 | 1760 |
| 8.33 | 47 | 116.6 | 36.1 | 97 | 206.6 | | | | 521 | 970 | 1778 |
| 8.89 | 48 | 118.4 | 36.7 | 98 | 208.4 | | | | 527 | 980 | 1796 |
| 9.44 | 49 | 120.2 | 37.2 | 99 | 210.2 | | | | 532 | 990 | 1814 |
| | | | 37.8 | 100 | 212.0 | | | | 538 | 1000 | 1832 |

Read known temperature in bold face type. Corresponding temperature in degrees Fahrenheit will be found in column to the right. Corresponding temperature in degrees will be found in column to the left.

PLASTIC AND HOSE

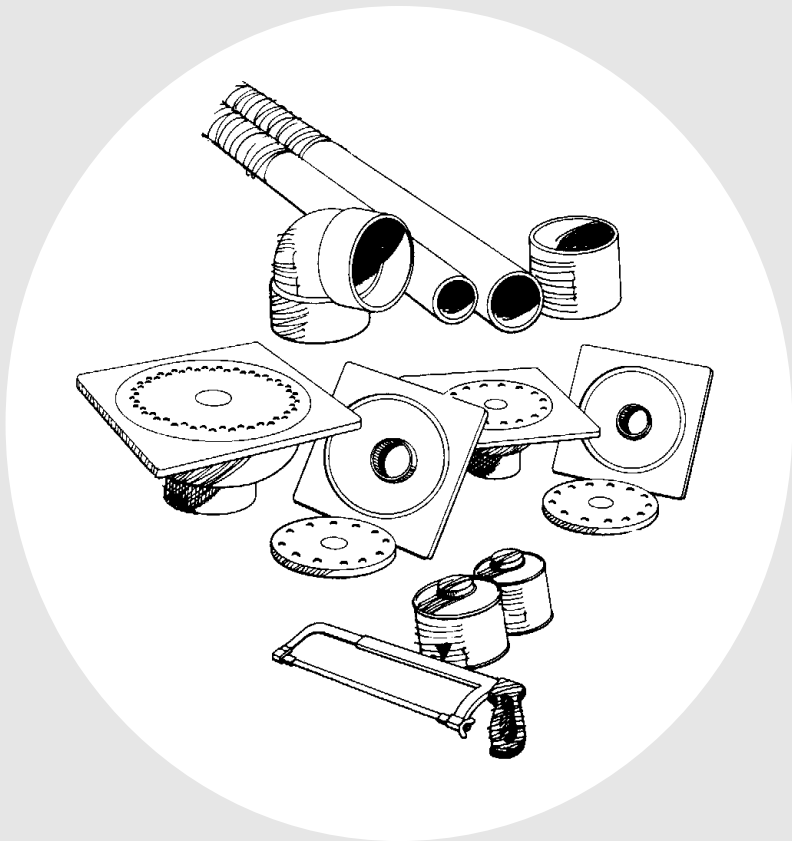

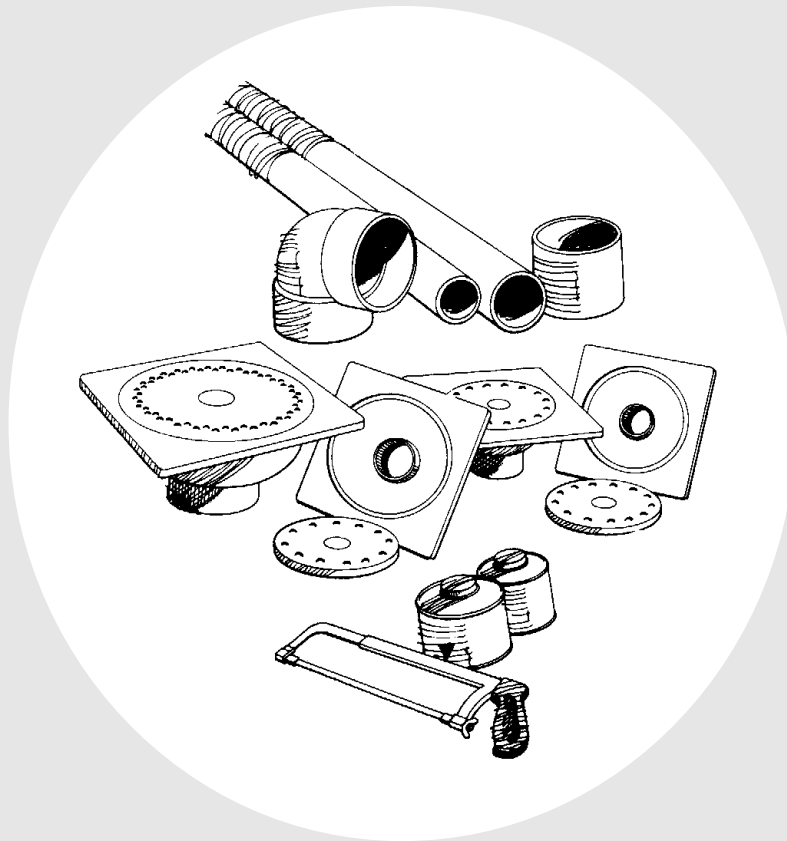

PLASTIC AND HOSE



PVC SCHEDULE 40 PRESSURE FITTINGS

| SIZE | FIG. NO. | PRICE |
|---|----------|-------|
| TEE (SXSXS) | | |
|  | | |
| 1/2 | 401-005 | |
| 3/4 | 401-007 | |
| 1 | 401-010 | |
| 1 1/4 | 401-012 | |
| 1 1/2 | 401-015 | |
| 2 | 401-020 | |
| 2 1/2 | 401-025 | |
| 3 | 401-030 | |
| 4 | 401-040 | |
| 5 | 401-050 | |
| 6 | 401-060 | |
| 8 | 401-080 | |

| SIZE | FIG. NO. | PRICE |
|---|----------|-------|
| TEE (SXSXT) | | |
|  | | |
| 1/2 | 402-005 | |
| 3/4 | 402-007 | |
| 1 | 402-010 | |
| 1 1/4 | 402-012 | |
| 1 1/2 | 402-015 | |
| 2 | 402-020 | |

| SIZE | FIG. NO. | PRICE |
|--|----------|-------|
| REDUCING TEE (SXSXT) | | |
|  | | |
| 3/4X3/4X1/2 | 402-101 | |
| 1X1X1/2 | 402-130 | |
| 1X1X3/4 | 402-131 | |
| 1 1/4X1 1/4X1 | 402-168 | |
| 1 1/2X1 1/2X1/2 | 402-209 | |
| 1 1/2X1 1/2X3/4 | 402-210 | |
| 1 1/2X1 1/2X1 | 402-211 | |
| 2X2X3/4 | 402-248 | |
| 2X2X1 | 402-249 | |
| 2X2X1 1/2 | 402-251 | |
| 2 1/2X2 1/2X3/4 | 402-288 | |
| 4X4X3 | 402-422 | |
| 6X6X3 | 402-530 | |

| SIZE | FIG. NO. | PRICE |
|---|----------|-------|
| REDUCING TEE (SXSXS) | | |
|  | | |
| 3/4x1/2x1/2 | 401-094 | |
| 3/4x1/2x3/4 | 401-095 | |
| 3/4x3/4x1/2 | 401-101 | |
| 1x3/4x1/2 | 401-124 | |
| 1x1x1/2 | 401-130 | |
| 1x1x3/4 | 401-131 | |
| 1x1x1 1/2 | 401-133 | |
| 1 1/4x1x1 | 401-158 | |
| 1 1/4x1 1/4 x 1 | 401-168 | |
| 1 1/4x1 1/4x2 | 401-170 | |
| 1 1/2x1 1/2x1/2 | 401-209 | |
| 1 1/2x1 1/2x3/4 | 401-210 | |
| 1 1/2x1 1/2x1 | 401-211 | |
| 1 1/2x1 1/2x1 1/4 | 401-212 | |
| 2x2x1/2 | 401-247 | |
| 2x2x3/4 | 401-248 | |
| 2x2x1 1/2 | 401-251 | |
| 2 1/2x2 1/2x1 | 401-289 | |
| 3x3x1 | 401-335 | |
| 3x3x1 1/4 | 401-336 | |
| 3x3x1 1/2 | 401-337 | |
| 3x3x2 | 401-338 | |
| 4x4x3/4 | 401-416 | |
| 4x4x2 | 401-420 | |
| 4x4x3 | 401-422 | |
| 6x6x2 | 401-528 | |
| 6x6x3 | 401-530 | |
| 6x6x4 | 401-532 | |
| 8x8x4 | 401-582 | |





| SIZE | FIG. NO. | PRICE |
|---|----------|-------|
| 90° ELL (SXS) | | |
|  | | |
| 1/2 | 406-005 | |
| 3/4 | 406-007 | |
| 1 | 406-010 | |
| 1 1/4 | 406-012 | |
| 1 1/2 | 406-015 | |
| 2 | 406-020 | |
| 2 1/2 | 406-025 | |
| 3 | 406-030 | |
| 4 | 406-040 | |
| 5 | 406-050 | |
| 6 | 406-060 | |
| 8 | 406-080 | |

| SIZE | FIG. NO. | PRICE |
|---|----------|-------|
| 90° REDUCING ELL (SXS) | | |
|  | | |
| 3/4 X 1/2 | 406-101 | |
| 1 X 1/2 | 406-130 | |
| 1 X 3/4 | 406-131 | |
| 1 1/4 X 1 | 406-168 | |
| 1 1/2 X 1 | 406-211 | |

| SIZE | FIG. NO. | PRICE |
|--|----------|-------|
| 90° ELL (SXT) | | |
|  | | |
| 1/2 | 407-005 | |
| 3/4 | 407-007 | |
| 1 | 407-010 | |
| 1 1/4 | 407-012 | |
| 1 1/2 | 407-015 | |
| 2 | 407-020 | |

| SIZE | FIG. NO. | PRICE |
|---|----------|-------|
| 90° REDUCING ELL (SXT) | | |
|  | | |
| 1/2 X 3/4 | 407-074 | |
| 3/4 X 1/2 | 407-101 | |
| 1 X 1/2 | 407-130 | |
| 1 X 3/4 | 407-131 | |
| 1 1/4 X 1 | 407-168 | |
| 1 1/2 X 1 | 407-211 | |

| SIZE | FIG. NO. | PRICE |
|---|----------|-------|
| 90° ELL (TXT) | | |
|  | | |
| 1/2 | 408-005 | |
| 3/4 | 408-007 | |
| 1 | 408-010 | |
| 1 1/4 | 408-012 | |

| SIZE | FIG. NO. | PRICE |
|---|----------|-------|
| 90° STREET ELL (SPGXS) | | |
|  | | |
| 1/2 | 409-005 | |
| 3/4 | 409-007 | |
| 1 | 409-010 | |
| 1 1/4 | 409-012 | |
| 1 1/2 | 409-015 | |
| 2 | 409-020 | |

PVC PIPE SCHEDULE 40 NSF

| NOM PIPE SIZE | OD | AVG ID | MAX WP PSI | FIG. NO. | PRICE PER LENGTH |
|---------------|--------|--------|------------|----------|------------------|
| 1/2 | .840 | .608 | 600 | 11420 | |
| 3/4 | 1.050 | .810 | 480 | 11425 | |
| 1 | 1.315 | 1.033 | 450 | 11428 | |
| 1 1/4 | 1.660 | 1.364 | 370 | 11431 | |
| 1 1/2 | 1.900 | 1.592 | 330 | 11433 | |
| 2 | 2.375 | 2.049 | 280 | 11435 | |
| 2 1/2 | 2.875 | 2.445 | 300 | 11437 | |
| 3 | 3.500 | 3.042 | 260 | 11438 | |
| 4 | 4.500 | 3.998 | 220 | 11439 | |
| 5 | 5.563 | 5.017 | 190 | 11440 | |
| 6 | 6.625 | 6.031 | 180 | 11441 | |
| 8 | 8.625 | 7.943 | 160 | 11442 | |
| 10 | 10.750 | 9.976 | 140 | 11443 | |
| 12 | 12.750 | 11.890 | 130 | 17755 | |

For additional information call: 610-275-4453 or Fax: 610-279-6299
Please call for current prices.



PVC SCHEDULE 40 PRESSURE FITTINGS

| | SIZE | FIG. NO. | PRICE |
|--|-------|----------|-------|
|  | 1/2 | 410-005 | |
| | 3/4 | 410-007 | |
| | 1 | 410-010 | |
| | 1 1/4 | 410-012 | |
| | 1 1/2 | 410-015 | |
| | 2 | 410-020 | |

| | SIZE | FIG. NO. | PRICE |
|--|-------|----------|-------|
|  | 1/2 | 412-005 | |
| | 3/4 | 412-007 | |
| | 1 | 412-010 | |
| | 1 1/4 | 412-012 | |
| | 1 1/2 | 412-015 | |
| | 2 | 412-020 | |

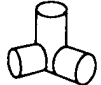
| | SIZE | FIG. NO. | PRICE |
|--|---------|----------|-------|
|  | 1/2 | 414-005 | |
| | :X:X2 | 414-101 | |
| | 1X1X1/2 | 414-130 | |

| | SIZE | FIG. NO. | PRICE |
|---|---------|----------|-------|
|  | 1/2 | 417-005 | |
| | 3/4 | 417-007 | |
| | 1 | 417-010 | |
| | 1 1/4 | 417-012 | |
| | 1 1/2 | 417-015 | |
| | 2 | 417-020 | |
| | 2 1/2 | 417-025 | |
| | 3 | 417-030 | |
| | 4 | 417-040 | |
| 5 | 417-050 | | |
| 6 | 417-060 | | |
| 8 | 417-080 | | |

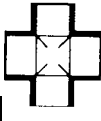
| | SIZE | FIG. NO. | PRICE |
|--|-------|----------|-------|
|  | 1/2 | 420-005 | |
| | 3/4 | 420-007 | |
| | 1 | 420-010 | |
| | 1 1/4 | 420-012 | |
| | 1 1/2 | 420-015 | |
| | 2 | 420-020 | |

| | SIZE | FIG. NO. | PRICE |
|---|---------|----------|-------|
|  | 1/2 | 429-005 | |
| | 3/4 | 429-007 | |
| | 1 | 429-010 | |
| | 1 1/4 | 429-012 | |
| | 1 1/2 | 429-015 | |
| | 2 | 429-020 | |
| | 2 1/2 | 429-025 | |
| | 3 | 429-030 | |
| | 4 | 429-040 | |
| | 5 | 429-050 | |
| | 6 | 429-060 | |
| | 8 | 429-080 | |
| | 3/4x1/2 | 429-101 | |
| 1x3/4 | 429-131 | | |

| | SIZE | FIG. NO. | PRICE |
|---|------|----------|-------|
|  | 1/2 | 430-005 | |
| | 3/4 | 430-007 | |
| | 1 | 430-010 | |

| | SIZE | FIG. NO. | PRICE |
|---|-------|----------|-------|
|  | 1/2 | 435-005 | |
| | 3/4 | 435-007 | |
| | 1 | 435-010 | |
| | 1 1/4 | 435-012 | |
| | 1 1/2 | 435-015 | |
| | 2 | 435-020 | |
| | 2 1/2 | 435-025 | |
| | 3 | 435-030 | |
| | 4 | 435-040 | |
| | 5 | 435-050 | |
| | 6 | 435-060 | |
| | 8 | 435-080 | |

| | SIZE | FIG. NO. | PRICE |
|---|---------|----------|-------|
|  | 3/4X1/2 | 435-101 | |
| | 3/4X1 | 435-102 | |
| | 1X3/4 | 435-131 | |

| | SIZE | FIG. NO. | PRICE |
|---|-------|----------|-------|
|  | 1/2 | 436-005 | |
| | 3/4 | 436-007 | |
| | 1 | 436-010 | |
| | 1 1/4 | 436-012 | |
| | 1 1/2 | 436-015 | |
| | 2 | 436-020 | |
| | 2 1/2 | 436-025 | |
| | 3 | 436-030 | |
| | 4 | 436-040 | |
| | 5 | 436-050 | |
| | 6 | 436-060 | |

| | SIZE | FIG. NO. | PRICE |
|---|-------------|----------|-------|
|  | 1/2X3/4 | 436-074 | |
| | 3/4X1/2 | 436-101 | |
| | 3/4X1 | 436-102 | |
| | 1X3/4 | 436-131 | |
| | 1X1 1/4 | 436-132 | |
| | 1 1/4X1 | 436-168 | |
| | 1 1/4X1 1/2 | 436-169 | |
| | 1 1/2X1 1/4 | 439-212 | |
| | 1 1/2X2 | 436-213 | |
| | 2X1 1/2X3 | 436-251 | |
| | 4 | 436-342 | |

| | SIZE | FIG. NO. | PRICE |
|---|-------------|----------|-------|
|  | 3/4X1/2 | 437-101 | |
| | 1X1/2 | 437-130 | |
| | 1X3/4 | 437-131 | |
| | 1 1/4x1/2 | 437-166 | |
| | 1 1/4x3/4 | 437-167 | |
| | 1 1/4X1 | 437-168 | |
| | 1 1/2X1/2 | 437-209 | |
| | 1 1/2x3/4 | 437-210 | |
| | 1 1/2X1 | 437-211 | |
| | 1 1/2X1 1/4 | 437-212 | |
| | 2X1/2 | 437-247 | |
| | 2X3/4 | 437-248 | |
| | 2X1 | 437-249 | |
| | 2X1 1/4 | 437-250 | |
| | 2X1 1/2 | 437-251 | |
| | 2 1/2X3/4 | 437-288 | |
| | 2 1/2X1 | 437-289 | |
| | 2 1/2X1 1/4 | 437-290 | |
| | 2 1/2X1 1/2 | 437-291 | |
| | 2 1/2X2 | 437-292 | |
| | 3X1 | 437-335 | |
| | 3X1 1/4 | 437-336 | |
| | 3X1 1/2 | 437-337 | |
| | 3X2 | 437-338 | |
| | 3X2 1/2 | 437-339 | |
| | 4X2 | 437-420 | |
| | 4X2 1/2 | 437-421 | |
| | 4X3 | 437-422 | |
| | 5X4 | 437-490 | |
| | 6X4 | 437-532 | |
| 6X5 | 437-534 | | |
| 8X4 | 437-582 | | |
| 8X6 | 437-585 | | |

| | SIZE | FIG. NO. | PRICE |
|---|---------|----------|-------|
|  | 1/2X1/2 | 434-005 | |



PVC SCHEDULE 40 PRESSURE FITTINGS

REDUCER BUSHING (SPGX1)



| SIZE | FIG. NO. | PRICE |
|-------------|----------|-------|
| 1/2X1/4 | 438-072 | |
| 1/2x3/8 | 438-073 | |
| 3/4x1/4 | 438-098 | |
| 3/4x1/2 | 438-101 | |
| 1x1/2 | 438-130 | |
| 1x3/4 | 438-131 | |
| 1 1/4x1/2 | 438-166 | |
| 1 1/4x3/4 | 438-167 | |
| 1 1/4x1 | 438-168 | |
| 1 1/2x1/2 | 438-209 | |
| 1 1/2x3/4 | 438-210 | |
| 1 1/2x1 | 438-211 | |
| 1 1/2x1 1/4 | 438-212 | |
| 2x1/2 | 438-247 | |
| 2x3/4 | 438-248 | |
| 2x1 | 438-249 | |
| 2x1 1/4 | 438-250 | |
| 2x1 1/2 | 438-251 | |
| 2 1/2x1 1/2 | 438-291 | |
| 2 1/2x2 | 438-292 | |
| 3x3/4 | 438-334 | |
| 3x1 | 438-335 | |
| 3x2 | 438-338 | |
| 3x2 1/2 | 438-339 | |
| 4x2 | 438-420 | |
| 4x2 1/2 | 438-421 | |
| 4x3 | 438-422 | |
| 6x4 | 438-532 | |

REDUCER BUSHING (MTXT)



| | |
|-------------|---------|
| 1/2x3/8 | 439-073 |
| 3/4x1/2 | 439-101 |
| 1x3/4 | 439-131 |
| 1 1/4x3/4 | 439-167 |
| 1 1/4x1 | 439-168 |
| 1 1/2x1/2 | 439-209 |
| 1 1/2x3/4 | 439-210 |
| 1 1/2x1 | 439-211 |
| 1 1/2x1 1/4 | 439-212 |
| 2X1 | 439-249 |
| 2x1 1/2 | 439-251 |

BUSHING FLUSH STYLE (SPGXS)



| | |
|-------------|---------|
| 3/4x1/2 | 437-101 |
| 1x3/4 | 437-131 |
| 1 1/2x1 1/4 | 437-212 |
| 2x1 1/2 | 437-251 |

DUFF IS ALWAYS OPEN

365 DAYS A YEAR

24 HR EMERGENCY SERVICE!

For additional information call: 610-275-4453 or Fax: 610-279-6299
Please call for current prices.

CAPS (SLIP)



| SIZE | FIG. NO. | PRICE |
|-------|----------|-------|
| 1/2 | 447-005 | |
| 3/4 | 447-007 | |
| 1 | 447-010 | |
| 1 1/4 | 447-012 | |
| 1 1/2 | 447-015 | |
| 2 | 447-020 | |
| 1 1/2 | 447-025 | |
| 3 | 447-030 | |
| 4 | 447-040 | |
| 5 | 447-050 | |
| 6 | 447-060 | |
| 8 | 447-080 | |

CAPS (THREADED)



| | |
|-------|---------|
| 1/2 | 448-005 |
| 3/4 | 448-007 |
| 1 | 448-010 |
| 1 1/4 | 448-012 |
| 1 1/2 | 448-015 |
| 2 | 448-020 |
| 2 1/2 | 448-025 |
| 3 | 448-030 |
| 4 | 448-040 |
| 5 | 448-050 |
| 6 | 448-060 |
| 8 | 448-080 |

PLUG (SPG)



| | |
|-------|---------|
| 1/2 | 449-005 |
| 3/4 | 449-007 |
| 1 | 449-010 |
| 1 1/4 | 449-012 |
| 1 1/2 | 449-015 |
| 2 | 449-020 |
| 3 | 449-030 |
| 4 | 449-040 |

PLUG (MT)



| | |
|-------|---------|
| 1/2 | 450-005 |
| 3/4 | 450-007 |
| 1 | 450-010 |
| 1 1/4 | 450-012 |
| 1 1/2 | 450-015 |
| 2 | 450-020 |
| 2 1/2 | 450-025 |
| 3 | 450-030 |
| 4 | 450-040 |

COUPLING LONG SOCKET SXS



| | |
|-------|---------|
| 1/2 | 479-005 |
| 1 1/2 | 482-015 |
| 2 | 482-020 |
| 2 1/2 | 482-025 |
| 3 | 482-030 |
| 4 | 482-040 |

FITTING THREAD ADA (SPGXFT)



| | |
|-------|---------|
| 1/2 | 478-005 |
| 3/4 | 478-007 |
| 1 | 478-010 |
| 1 1/2 | 478-015 |
| 2 | 478-020 |
| 4 | 478-040 |

CONDENSATE TRAP

Running Trap



3/4 15793

P-Trap



3/4 15826

FOR A COMPLETE LISTING OF SOLVENTS, PLEASE SEE PAGE 608





DUFF DELIVERS!

PVC SCHEDULE 80 PRESSURE FITTINGS

| SIZE | FIG. NO. | PRICE |
|---|----------|---------|
| TEE (SXSXS) | | |
|  | 1/4 | 801-002 |
| | 3/8 | 801-003 |
| | 1/2 | 801-005 |
| | 3/4 | 801-007 |
| | 1 | 801-010 |
| | 1 1/4 | 801-012 |
| | 1 1/2 | 801-015 |
| | 2 | 801-020 |
| | 2 1/2 | 801-025 |
| | 3 | 801-030 |
| | 4 | 801-040 |
| | 6 | 801-060 |
| | 8 | 801-080 |

| SIZE | FIG. NO. | PRICE |
|---|----------|---------|
| REDUCING TEE (SXSXS) | | |
|  | 4X4X2 | 801-420 |
| | 6X6X4 | 801-532 |
| | 8X8X6 | 801-585 |

| SIZE | FIG. NO. | PRICE |
|---|----------|---------|
| TEE (SXSXT) | | |
|  | 1/2 | 802-005 |
| | 3/4 | 802-007 |
| | 1 | 802-010 |

| SIZE | FIG. NO. | PRICE |
|---|----------|---------|
| TEE (TXTXT) | | |
|  | 1/4 | 805-002 |
| | 3/8 | 805-003 |
| | 1/2 | 805-005 |
| | 3/4 | 805-007 |
| | 1 | 805-010 |
| | 1 1/4 | 805-012 |
| | 1 1/2 | 805-015 |
| | 2 | 805-020 |
| | 2 1/2 | 805-025 |
| | 3 | 805-030 |
| | 4 | 805-040 |

| SIZE | FIG. NO. | PRICE |
|---|----------|---------|
| 90° ELL (SXS) | | |
|  | 1/4 | 806-002 |
| | 3/8 | 806-003 |
| | 1/2 | 806-005 |
| | 3/4 | 806-007 |
| | 1 | 806-010 |
| | 1 1/4 | 806-012 |
| | 1 1/2 | 806-015 |
| | 2 | 806-020 |
| | 2 1/2 | 806-025 |
| | 3 | 806-030 |
| | 4 | 806-040 |
| | 6 | 806-060 |
| | 8 | 806-080 |

| SIZE | FIG. NO. | PRICE |
|---|----------|---------|
| 90° ELL (SXFIPT) | | |
|  | 1/2 | 807-005 |
| | 3/4 | 807-007 |
| | 1 | 807-010 |
| | 1 1/4 | 807-012 |
| | 1 1/2 | 807-015 |
| | 2 | 807-020 |
| | 3 | 807-030 |

| SIZE | FIG. NO. | PRICE |
|---|----------|---------|
| 90° ELL (TXT) | | |
|  | 1/4 | 808-002 |
| | 3/8 | 808-003 |
| | 1/2 | 808-005 |
| | 3/4 | 808-007 |
| | 1 | 808-010 |
| | 1 1/4 | 808-012 |
| | 1 1/2 | 808-015 |
| | 2 | 808-020 |
| | 2 1/2 | 808-025 |
| | 3 | 808-030 |
| | 4 | 808-040 |

| SIZE | FIG. NO. | PRICE |
|--|----------|---------|
| 45° ELL (SXS) | | |
|  | 1/4 | 817-002 |
| | 3/8 | 817-003 |
| | 1/2 | 817-005 |
| | 3/4 | 817-007 |
| | 1 | 817-010 |
| | 1 1/4 | 817-012 |
| | 1 1/2 | 817-015 |
| | 2 | 817-020 |
| | 2 1/2 | 817-025 |
| | 3 | 817-030 |
| | 4 | 817-040 |
| | 6 | 817-060 |
| | 8 | 817-080 |

| SIZE | FIG. NO. | PRICE |
|---|----------|---------|
| 45° ELL (TXT) | | |
|  | 1/4 | 819-002 |
| | 3/8 | 819-003 |
| | 1/2 | 819-005 |
| | 3/4 | 819-007 |
| | 1 | 819-010 |
| | 1 1/4 | 819-012 |
| | 1 1/2 | 819-015 |
| | 2 | 819-020 |
| | 3 | 819-030 |
| | 4 | 819-040 |

| SIZE | FIG. NO. | PRICE |
|---|----------|---------|
| COUPLING (SXS) | | |
|  | 1/4 | 829-002 |
| | 3/8 | 829-003 |
| | 1/2 | 829-005 |
| | 3/4 | 829-007 |
| | 1 | 829-010 |
| | 1 1/4 | 829-012 |
| | 1 1/2 | 829-015 |

| SIZE | FIG. NO. | PRICE |
|---|----------|---------|
| COUPLING (SXS) CONTINUED | | |
|  | 2 | 829-020 |
| | 2 1/2 | 829-025 |
| | 3 | 829-030 |
| | 4 | 829-040 |
| | 6 | 829-060 |
| | 8 | 829-080 |

| SIZE | FIG. NO. | PRICE |
|---|-------------|---------|
| REDUCER COUPLING (SXS) | | |
|  | 3/4X1/2 | 829-101 |
| | 1X1/2 | 829-130 |
| | 1X3/4 | 829-131 |
| | 1 1/4X1 | 829-168 |
| | 1 1/2X1 | 829-211 |
| | 1 1/2X1 1/4 | 829-212 |
| | 2X1 1/2 | 829-251 |
| | 3X2 | 829-338 |
| | 4X3 | 829-422 |
| | 6X4 | 829-532 |
| | 8X6 | 829-585 |

| SIZE | FIG. NO. | PRICE |
|---|----------|---------|
| COUPLING (TXT) | | |
|  | 1/4 | 830-002 |
| | 3/8 | 830-003 |
| | 1/2 | 830-005 |
| | 3/4 | 830-007 |
| | 1 | 830-010 |
| | 1 1/4 | 830-012 |
| | 1 1/2 | 830-015 |
| | 2 | 830-020 |
| | 2 1/2 | 830-025 |
| | 3 | 830-030 |
| | 4 | 830-040 |

| SIZE | FIG. NO. | PRICE |
|---|-----------|-------|
| REDUCER COUPLING (TXT) | | |
|  | 3/8X1/4 | 52758 |
| | 1/2X1/4 | 52759 |
| | 3/4X1/2 | 57854 |
| | 1X1/2 | 57855 |
| | 1X3/4 | 57856 |
| | 1 1/4X3/4 | 52761 |
| | 1 1/2X1 | 52764 |
| | 2X1 1/2 | 52767 |

| SIZE | FIG. NO. | PRICE |
|---|----------|---------|
| FEMALE ADAPTER (SXT) | | |
|  | 1/4 | 835-002 |
| | 3/8 | 835-003 |
| | 1/2 | 835-005 |
| | 3/4 | 835-007 |
| | 1 | 835-010 |
| | 1 1/4 | 835-012 |
| | 1 1/2 | 835-015 |
| | 2 | 835-020 |
| | 2 1/2 | 835-025 |
| | 3 | 835-030 |
| | 4 | 835-040 |

PVC SCHEDULE 80 PRESSURE FITTINGS

| SIZE | FIG. NO. | PRICE |
|---|-------------|---------|
| REDUCER BUSHING (SpXS) | | |
|  | 12/X1/4 | 837-072 |
| | 1/2X3/8 | 837-073 |
| | 3/4X1/2 | 837-101 |
| | 1X1/2 | 837-130 |
| | 1X3/4 | 837-131 |
| | 1 1/4X3/4 | 837-167 |
| | 1 1/4X1 | 837-168 |
| | 1 1/2X1/2 | 837-209 |
| | 1 1/2X3/4 | 837-210 |
| | 1 1/2X1 | 837-211 |
| | 1 1/2X1 1/4 | 837-212 |
| | 2X1/2 | 837-247 |
| | 2X3/4 | 837-248 |
| | 2X1 | 837-249 |
| | 2X1 1/4 | 837-250 |
| | 2X1 1/2 | 837-251 |
| | 2 1/2X1 1/2 | 837-291 |
| | 2 1/2X2 | 837-292 |
| | 3X2 | 837-338 |
| | 3X2 1/2 | 837-339 |
| | 4X2 | 837-420 |
| | 4X3 | 837-422 |
| | 6X4 | 837-532 |

| | | |
|--|-------------|---------|
| REDUCER BUSHING (SpXT) | | |
|  | 3/8X1/4 | 838-052 |
| | 1/2X1/4 | 838-072 |
| | 1/2X3/8 | 838-073 |
| | 3/4X1/2 | 838-101 |
| | 1X1/2 | 838-130 |
| | 1X3/4 | 838-131 |
| | 1 1/4X1/2 | 838-166 |
| | 1 1/4X3/4 | 838-167 |
| | 1 1/4X1 | 838-168 |
| | 1 1/2X1/2 | 838-209 |
| | 1 1/2X3/4 | 838-210 |
| | 1 1/2X1 | 838-211 |
| | 1 1/2X1 1/4 | 838-212 |
| | 2X1/2 | 838-247 |
| | 2X3/4 | 838-248 |
| | 2X1 | 838-249 |
| | 2X1 1/4 | 838-250 |
| | 2X1 1/2 | 838-251 |
| | 2 1/2X1 1/2 | 838-291 |
| | 2 1/2X2 | 838-292 |
| | 3X2 | 838-338 |
| | 3X2 1/2 | 838-339 |
| | 4X2 | 838-420 |

| | | |
|---|-----------|---------|
| REDUCER BUSHING (TXT) | | |
|  | 3/8X1/4 | 839-052 |
| | 1/2X1/4 | 839-072 |
| | 1/2X3/8 | 839-073 |
| | 3/4X1/4 | 839-098 |
| | 3/4X3/8 | 839-099 |
| | 3/4X1/2 | 839-101 |
| | 1X1/4 | 839-128 |
| | 1X1/2 | 839-130 |
| | 1X3/4 | 839-131 |
| | 1 1/4X1/2 | 839-166 |
| | 1 1/4X3/4 | 839-167 |

| SIZE | FIG. NO. | PRICE |
|---|-------------|---------|
| REDUCER BUSHING (TXT) CONT'D | | |
|  | 1 1/4X1 | 839-168 |
| | 1 1/2X3/4 | 839-210 |
| | 1 1/2X1 | 839-211 |
| | 1 1/2X1 1/4 | 839-212 |
| | 2X1/2 | 839-247 |
| | 2X3/4 | 839-248 |
| | 2X1 | 839-249 |
| | 2X1 1/4 | 839-250 |
| | 2X1 1/2 | 839-251 |
| | 3X2 | 839-338 |
| | 4X2 | 839-420 |
| | 4X3 | 839-422 |

| | | |
|---|-------|---------|
| CAPS (S) | | |
|  | 1/4 | 847-002 |
| | 3/8 | 847-003 |
| | 1/2 | 847-005 |
| | 3/4 | 847-007 |
| | 1 | 847-010 |
| | 1 1/4 | 847-012 |
| | 1 1/2 | 847-015 |
| | 2 | 847-020 |
| | 2 1/2 | 847-025 |
| | 3 | 847-030 |
| | 4 | 847-040 |
| | 6 | 847-060 |
| | 8 | 847-080 |

| | | |
|---|-------|---------|
| CAPS (T) | | |
|  | 1/4 | 848-002 |
| | 3/8 | 848-003 |
| | 1/2 | 848-005 |
| | 3/4 | 848-007 |
| | 1 | 848-010 |
| | 1 1/4 | 848-012 |
| | 1 1/2 | 848-015 |
| | 2 | 848-020 |
| | 2 1/2 | 848-025 |
| | 3 | 848-030 |
| | 4 | 848-040 |

| | | |
|---|---|---------|
| PLUG (Sp) | | |
|  | 2 | 849-020 |

| | | |
|---|-------|---------|
| PLUG (MT) | | |
|  | 1/4 | 850-002 |
| | 3/8 | 850-003 |
| | 1/2 | 850-005 |
| | 3/4 | 850-007 |
| | 1 | 850-010 |
| | 1 1/4 | 850-012 |
| | 1 1/2 | 850-015 |
| | 2 | 850-020 |
| | 3 | 850-030 |
| | 4 | 850-040 |

| SIZE | FIG. NO. | PRICE |
|---|----------|---------|
| FLANGE (Blind) | | |
|  | 1 1/2 | 853-015 |
| | 2 | 853-020 |
| | 3 | 853-030 |
| | 4 | 853-040 |

| | | |
|---|-------|---------|
| VAN STONE FLANGE (S) | | |
|  | 1/2 | 854-005 |
| | 3/4 | 854-007 |
| | 1 | 854-010 |
| | 1 1/4 | 854-012 |
| | 1 1/2 | 854-015 |
| | 2 | 854-020 |
| | 2 1/2 | 854-025 |
| | 3 | 854-030 |
| | 4 | 854-040 |
| | 6 | 854-060 |
| | 8 | 854-080 |
| | 10 | 854-100 |
| | 12 | 854-120 |

| | | |
|--|-------|---------|
| VAN STONE FLANGE (T) | | |
|  | 1/2 | 855-005 |
| | 3/4 | 855-007 |
| | 1 | 855-010 |
| | 1 1/4 | 855-012 |
| | 1 1/2 | 855-015 |
| | 2 | 855-020 |
| | 22 | 855-025 |
| | 3 | 855-030 |
| | 4 | 855-040 |

**DON'T SEE WHAT
YOUR LOOKING
FOR?**

CALL US!

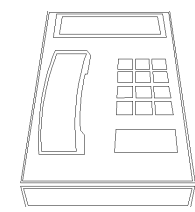

WE WILL HELP!

610-275-4453

PVC SCHEDULE 80 PRESSURE FITTINGS

| SIZE | FIG. NO. | PRICE |
|---|----------|---------|
| VAN STONE FLANGE (SPG) | | |
|  | 1/2 | 856-005 |
| | 3/4 | 856-007 |
| | 1 | 856-010 |
| | 1 1/4 | 856-012 |
| | 1 1/2 | 856-015 |
| | 2 | 856-020 |
| | 2 1/2 | 856-025 |
| | 3 | 856-030 |
| 4 | 856-040 | |
| 6 | 856-060 | |
| 8 | 856-080 | |

| SIZE | FIG. NO. | PRICE |
|----------------|----------|-------|
| 45° WYE | | |
| 6X6X6 | 875-060 | |

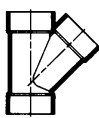

| SIZE | FIG. NO. | PRICE |
|-------------------------|----------|-------|
| 45° REDUCING WYE | | |
| 6X6X4 | 876-532 | |

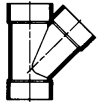

| SIZE | FIG. NO. | PRICE |
|----------------|----------|-------|
| 45° ELL | | |
| 6 | 817-060 | |



| SIZE | FIG. NO. | PRICE |
|----------------|----------|-------|
| 30° ELL | | |
| 6 | 815-060 | |



| SIZE | FIG. NO. | PRICE |
|---------------------------|----------|-------|
| UNION O-RING (SXS) | | |
| 1/4 | 897-002 | |
| 3/8 | 897-003 | |
| 1/2 | 897-005 | |
| 3/4 | 897-007 | |
| 1 | 897-010 | |
| 1 1/4 | 897-012 | |
| 1 1/2 | 897-015 | |
| 2 | 897-020 | |
| 3 | 897-030 | |



| SIZE | FIG. NO. | PRICE |
|---------------------------|----------|-------|
| UNION O-RING (TXT) | | |
| 1/4 | 898-002 | |
| 3/8 | 898-003 | |
| 1/2 | 898-005 | |
| 3/4 | 898-007 | |
| 1 | 898-010 | |
| 1 1/4 | 898-012 | |
| 1 1/2 | 898-015 | |
| 2 | 898-020 | |
| 3 | 898-030 | |



| WYE STRAINER (SXS) | | |
|---------------------------|-------|--|
| SLIP | | |
| 1/4 | 43692 | |
| 3/8 | 43693 | |
| 1/2 | 38775 | |
| 3/4 | 38776 | |
| 1 | 38777 | |
| 1 1/4 | 38778 | |
| 1 1/2 | 38779 | |
| 2 | 38780 | |
| THREADED | | |
| 1/2 | 33773 | |
| 3/4 | 33774 | |
| 1 | 33775 | |
| 1 1/4 | 33776 | |
| 1 1/2 | 33777 | |
| 2 | 33778 | |



**FOR A
COMPLETE
LISTING
OF
SOLVENTS,
PLEASE
SEE
PAGE 608**



SCHEDULE 80 PVC PIPE



| NOM PIPE SIZE | O.D. | AVE I.D. | MAX WP PSI | FIG. NO. | PRICE |
|---------------|--------|----------|------------|----------|-------|
| 1/8 | .405 | .203 | 1230 | 11492 | |
| 1/4 | .540 | .288 | 1130 | 11493 | |
| 3/8 | .675 | .407 | 920 | 11494 | |
| 1/2 | .840 | .528 | 850 | 11461 | |
| 3/4 | 1.050 | .724 | 690 | 11462 | |
| 1 | 1.315 | .935 | 630 | 11463 | |
| 1 1/4 | 1.660 | 1.256 | 520 | 11464 | |
| 1 1/2 | 1.900 | 1.476 | 470 | 11465 | |
| 2 | 2.375 | 1.913 | 400 | 11466 | |
| 2 1/2 | 2.875 | 2.289 | 420 | 11467 | |
| 3 | 3.500 | 2.864 | 370 | 11468 | |
| 4 | 4.500 | 3.786 | 320 | 11469 | |
| 5 | 5.563 | 4.767 | 290 | 38152 | |
| 6 | 6.625 | 5.709 | 280 | 11470 | |
| 8 | 8.625 | 7.565 | 250 | 11471 | |
| 10 | 10.750 | 9.492 | 230 | 47543 | |
| 12 | 12.750 | 11.294 | 230 | 47544 | |

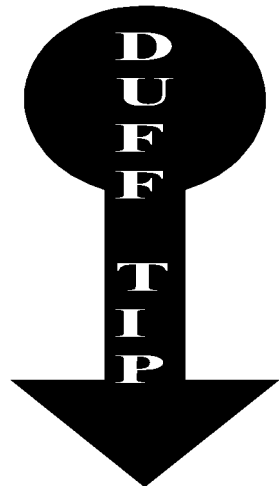

**DON'T FORGET
TO CHECK
YOUR SUPPLY
OF
PVC CLEANER
AND CEMENT!**

CPVC SCHEDULE 80 PRESSURE FITTINGS AND PIPE

SCHEDULE 80 HI-TEMP CPVC PIPE

**20'
LENGTHS**



Chlorinated Poly (vinyl chloride) CPVC - An industrial thermoplastic piping material which can be used for higher temperature applications.

CPVC retains its mechanical strength at higher temperatures

Compare: CPVC=200° F max

PVC=140° F max

| NOMINAL PIPE SIZE | O.D. | AVERAGE I.D. | MAX WP PSI | FIG. NO. | PRICE |
|-------------------|-------|--------------|------------|----------|-------|
| 1/4 | .540 | .288 | 1130 | 9360 | |
| 3/8 | .675 | .407 | 915 | 9362 | |
| 1/2 | .840 | .528 | 850 | 9339 | |
| 3/4 | 1.050 | .724 | 690 | 9341 | |
| 1 | 1.315 | .935 | 630 | 9342 | |
| 1 1/4 | 1.660 | 1.256 | 520 | 9344 | |
| 1 1/2 | 1.900 | 1.476 | 470 | 9345 | |
| 2 | 2.375 | 1.913 | 400 | 9346 | |
| 2 1/2 | 2.875 | 2.289 | 425 | 71292 | |
| 3 | 3.500 | 2.864 | 375 | 9347 | |
| 4 | 4.500 | 3.786 | 320 | 9348 | |
| 6 | 6.625 | 5.709 | 270 | 52605 | |

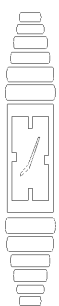

**DUFF KNOWS...
TIME IS MONEY!
CALL OR FAX
YOUR ORDER
FOR FAST SERVICE**

LARGE DIAMETER PVC
FABRICATED FITTINGS
8" THRU 24"

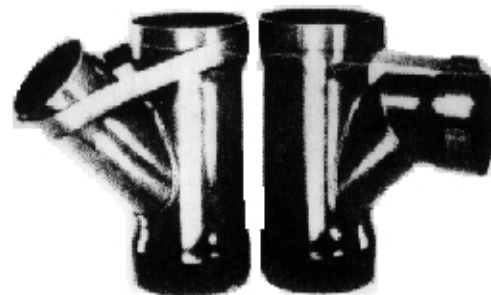

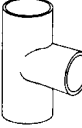

CALL TODAY WITH YOUR SPECIFICATIONS!

CPVC HEAVY DUTY SCHEDULE 80 PRESSURE FITTINGS

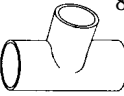
| SIZE | FIG. NO. | PRICE |
|---|----------|----------|
| TEE (SXSXS) | | |
|  | 1/2 | 9801-005 |
| | 3/4 | 9801-007 |
| | 1 | 9801-010 |
| | 1 1/4 | 9801-012 |
| | 1 1/2 | 9801-015 |
| | 2 | 9801-020 |
| | 22 | 9801-025 |
| | 3 | 9801-030 |
| | 4 | 9801-040 |
| | 6 | 9801-060 |
| | 8 | 9801-080 |

| SIZE | FIG. NO. | PRICE |
|--|----------|----------|
| REDUCING TEE (SXSXS) | | |
|  | 8X8X6 | 9801-585 |

| SIZE | FIG. NO. | PRICE |
|---|----------|----------|
| TEE (TXTXT) | | |
|  | 1/4 | 9805-002 |
| | 3/8 | 9805-003 |
| | 1/2 | 9805-005 |
| | 3/4 | 9805-007 |
| | 1 | 9805-010 |
| | 1 1/4 | 9805-012 |
| | 1 1/2 | 9805-015 |
| | 2 | 9805-020 |

| SIZE | FIG. NO. | PRICE |
|--|----------|----------|
| 90° (SXS) | | |
|  | 1/4 | 9806-002 |
| | 3/8 | 9806-003 |
| | 1/2 | 9806-005 |
| | 3/4 | 9806-007 |
| | 1 | 9806-010 |
| | 1 1/4 | 9806-012 |
| | 1 1/2 | 9806-015 |
| | 2 | 9806-020 |
| | 2 1/2 | 9806-025 |
| | 3 | 9806-030 |
| | 4 | 9806-040 |
| | 6 | 9806-060 |
| | 8 | 9806-080 |

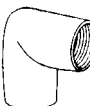
| SIZE | FIG. NO. | PRICE |
|--|----------|----------|
| 90° (TXT) | | |
|  | 1/4 | 9808-002 |
| | 3/8 | 9808-003 |
| | 1/2 | 9808-005 |
| | 3/4 | 9808-007 |
| | 1 | 9808-010 |
| | 1 1/4 | 9808-012 |
| | 1 1/2 | 9808-015 |
| | 2 | 9808-020 |

| SIZE | FIG. NO. | PRICE |
|---|----------|----------|
| 45° ELL (SXS) | | |
|  | 1/4 | 9817-002 |
| | 3/8 | 9817-003 |
| | 1/2 | 9817-005 |
| | 3/4 | 9817-007 |
| | 1 | 9817-010 |
| | 1 1/4 | 9817-012 |
| | 1 1/2 | 9817-015 |
| | 2 | 9817-020 |
| | 2 1/2 | 9817-025 |
| | 3 | 9817-030 |
| | 4 | 9817-040 |
| | 6 | 9817-060 |
| | 8 | 9817-080 |

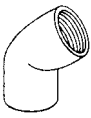
| SIZE | FIG. NO. | PRICE |
|---|----------|----------|
| 45° ELL (TXT) | | |
|  | 1/4 | 9819-002 |
| | 3/8 | 9819-003 |
| | 1/2 | 9819-005 |
| | 3/4 | 9819-007 |
| | 1 | 9819-010 |
| | 1 1/4 | 9819-012 |
| | 1 1/2 | 9819-015 |
| | 2 | 9819-020 |
| | 2 1/2 | 9819-025 |
| | 3 | 9819-030 |

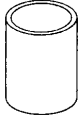
| SIZE | FIG. NO. | PRICE |
|---|----------|----------|
| COUPLING (SXS) | | |
|  | 1/4 | 9829-002 |
| | 3/8 | 9829-003 |
| | 1/2 | 9829-005 |
| | 3/4 | 9829-007 |
| | 1 | 9829-010 |
| | 1 1/4 | 9829-012 |
| | 1 1/2 | 9829-015 |
| | 2 | 9829-020 |
| | 2 1/2 | 9829-025 |
| | 3 | 9829-030 |
| | 4 | 9829-040 |
| | 6 | 9829-060 |
| | 8 | 9829-080 |

| SIZE | FIG. NO. | PRICE |
|---|-------------|----------|
| REDUCER COUPLING (SXS) | | |
|  | 1/2X1/4 | 9829-073 |
| | 3/4X1/2 | 9829-101 |
| | 1X1/2 | 9829-130 |
| | 1X3/4 | 9829-131 |
| | 1 1/2X1 | 9829-211 |
| | 1 1/2X1 1/4 | 9829-212 |
| | 2X1 1/2 | 9829-251 |
| | 3X2 | 9829-338 |
| | 4X3 | 9829-422 |
| | 8X6 | 9829-585 |

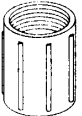
| SIZE | FIG. NO. | PRICE |
|---|----------|----------|
| COUPLING (TXT) | | |
|  | 1/4 | 9830-002 |
| | 3/8 | 9830-003 |
| | 1/2 | 9830-005 |
| | 3/4 | 9830-007 |
| | 1 | 9830-010 |
| | 1 1/2 | 9830-015 |
| | 2 | 9830-020 |

| SIZE | FIG. NO. | PRICE |
|---|----------|----------|
| FEMALE ADAPTER (SXT) | | |
|  | 1/4 | 9835-002 |
| | 3/8 | 9835-003 |
| | 1/2 | 9835-005 |
| | 3/4 | 9835-007 |
| | 1 | 9835-010 |
| | 1 1/4 | 9835-012 |
| | 1 1/2 | 9835-015 |
| | 2 | 9835-020 |
| | 3 | 9835-030 |
| | 4 | 9835-040 |

| SIZE | FIG. NO. | PRICE |
|---|----------|----------|
| MALE ADAPTER (SXMT) | | |
|  | 1/2 | 9836-005 |
| | 3/4 | 9836-007 |
| | 1 | 9836-010 |
| | 1 1/4 | 9836-012 |
| | 1 1/2 | 9836-015 |

| SIZE | FIG. NO. | PRICE |
|---|----------|----------|
| CAPS (S) | | |
|  | 3/8 | 9847-003 |
| | 1/2 | 9847-005 |
| | 3/4 | 9847-007 |
| | 1 | 9847-010 |
| | 1 1/4 | 9847-012 |
| | 1 1/2 | 9847-015 |
| | 2 | 9847-020 |
| | 2 1/2 | 9847-025 |
| | 3 | 9847-030 |
| | 4 | 9847-040 |
| | 6 | 9847-060 |
| | 8 | 9847-080 |

| SIZE | FIG. NO. | PRICE |
|---|----------|----------|
| CAPS (T) | | |
|  | 1/4 | 9848-002 |
| | 3/8 | 9848-003 |
| | 1/2 | 9848-005 |
| | 3/4 | 9848-007 |
| | 1 | 9848-010 |
| | 1 1/4 | 9848-012 |
| | 1 1/2 | 9848-015 |
| | 2 | 9848-020 |
| | 3 | 9848-030 |
| | 4 | 9848-040 |

CPVC SCHEDULE 80 PRESSURE FITTINGS

| SIZE | FIG. NO. | PRICE |
|---|-------------|----------|
| REDUCER BUSHING (SPGXS) | | |
|  | 1/2X1/4 | 9837-072 |
| | 1/2X3/8 | 9837-073 |
| | 3/4X1/2 | 9837-101 |
| | 1X1/2 | 9837-130 |
| | 1X3/4 | 9837-131 |
| | 1 1/4X1/2 | 9837-166 |
| | 1 1/4X3/4 | 9837-167 |
| | 1 1/4X1 | 9837-168 |
| | 1 1/2X1/2 | 9837-209 |
| | 1 1/2X3/4 | 9837-210 |
| | 1 1/2X1 | 9837-211 |
| | 1 1/2X1 1/4 | 9837-212 |
| | 2X1/2 | 9837-247 |
| | 2X3/4 | 9837-248 |
| | 2X1 | 9837-249 |
| | 2X1 1/4 | 9837-250 |
| | 2X1 1/2 | 9837-251 |
| | 2 1/2X1 1/2 | 837-291 |
| | 2 1/2X2 | 9837-292 |
| | 3X2 | 9837-338 |
| | 3X2 1/2 | 9837-339 |
| | 4X2 | 9837-420 |
| | 4X3 | 9837-422 |
| | 6X4 | 9837-532 |

| SIZE | FIG. NO. | PRICE |
|---|-------------|----------|
| REDUCER BUSHING (SPGXT) | | |
|  | 3/8X1/4 | 9838-052 |
| | 1/2X3/8 | 9838-072 |
| | 3/4X1/2 | 9838-073 |
| | 1X1/2 | 9838-101 |
| | 1X3/4 | 9838-130 |
| | 1 1/4X1/2 | 9838-131 |
| | 1 1/4X3/4 | 838-166 |
| | 1 1/4X1 | 838-167 |
| | 1 1/2X1/2 | 9838-168 |
| | 1 1/2X3/4 | 9838-209 |
| | 1 1/2X1 | 9838-210 |
| | 1 1/2X1 1/4 | 9838-211 |
| | 2X1/2 | 9838-212 |
| | 2X3/4 | 838-247 |
| | 2X1 | 9838-248 |
| | 2X1 1/4 | 9838-249 |
| | 2X1 1/2 | 838-250 |
| | 2 1/2X1 1/2 | 9838-251 |
| | 2 1/2X2 | 838-291 |
| | 3X2 | 9838-292 |
| | 3X2 1/2 | 9838-338 |
| | 4X2 | 9838-420 |
| | 4X3 | 9838-422 |

| SIZE | FIG. NO. | PRICE |
|---|-------------|----------|
| REDUCER BUSHING (MTXT) | | |
|  | 3/4X1/2 | 9839-101 |
| | X3/4 | 9839-131 |
| | 1 1/4X1 | 9839-168 |
| | 1 1/2X1 1/4 | 9839-212 |
| | 2X1 1/2 | 9839-251 |

| SIZE | FIG. NO. | PRICE |
|---|----------|----------|
| PLUG (MT) | | |
|  | 1/4 | 9850-002 |
| | 3/8 | 850-003 |
| | 1/2 | 9850-005 |
| | 3/4 | 9850-007 |
| | 1 | 9850-010 |
| | 1 1/2 | 9850-015 |
| | 2 | 9850-020 |
| | 3 | 9850-030 |
| | 4 | 9850-040 |

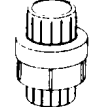
| SIZE | FIG. NO. | PRICE |
|---|----------|----------|
| UNION O-RING (SXS) | | |
|  | 1/4 | 9897-002 |
| | 1/2 | 9897-005 |
| | 3/4 | 9897-007 |
| | 1 | 9897-010 |
| | 1 1/4 | 9897-012 |
| | 1 1/2 | 9897-015 |
| | 2 | 9897-020 |
| | 3 | 9897-030 |

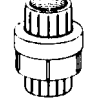
| SIZE | FIG. NO. | PRICE |
|--|----------|----------|
| UNION O-RING (TXT) | | |
|  | 3/8 | 9898-003 |
| | 1/2 | 9898-005 |
| | 3/4 | 9898-007 |
| | 1 | 9898-010 |
| | 1 1/4 | 9898-012 |
| | 1 1/2 | 9898-015 |
| | 2 | 9898-020 |

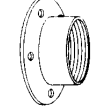

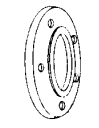
| SIZE | FIG. NO. | PRICE |
|---|----------|----------|
| FLANGE (T) | | |
|  | 1/2 | 9852-005 |
| | 3/4 | 9852-007 |
| | 1 | 9852-010 |
| | 1 1/2 | 9852-015 |
| | 2 | 9852-020 |
| | 3 | 9852-030 |
| | 4 | 9852-040 |

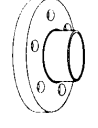
| SIZE | FIG. NO. | PRICE |
|---|----------|----------|
| FLANGE (BLIND) | | |
|  | 1 1/2 | 9853-015 |
| | 2 | 9853-020 |
| | 3 | 9853-030 |
| | 4 | 9853-040 |
| | 6 | 9853-060 |
| | 8 | 9853-080 |

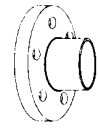
| SIZE | FIG. NO. | PRICE |
|---|----------|----------|
| VAN STONE FLANGE (S) | | |
|  | 1/2 | 9854-005 |
| | 3/4 | 9854-007 |
| | 1 | 9854-010 |
| | 1 1/4 | 9854-012 |
| | 1 1/2 | 9854-015 |
| | 2 | 9854-020 |
| | 2 1/2 | 9854-025 |
| | 3 | 9854-030 |
| | 4 | 9854-040 |
| | 5 | 9854-060 |
| | 8 | 9854-080 |
| | 10 | 9854-100 |
| | 12 | 9854-120 |

| SIZE | FIG. NO. | PRICE |
|---|----------|----------|
| VAN STONE FLANGE (SPG) | | |
|  | 1/2 | 9856-005 |
| | 3/4 | 9856-007 |
| | 1 | 9856-010 |
| | 1 1/4 | 9856-012 |
| | 1 1/2 | 9856-015 |
| | 2 | 9856-020 |
| | 2 1/2 | 856-025 |
| | 3 | 856-030 |
| | 4 | 856-040 |
| | 6 | 856-060 |
| | 8 | 856-080 |

**FOR A
COMPLETE
LISTING
OF
SOLVENTS,
PLEASE
SEE
PAGE 608**



For additional information call: 610-275-4453 or Fax: 610-279-6299
Please call for current prices.

PLASTIC NIPPLES

P V C S C H E D U L E 8 0

D I A M E T E R



L E N G T H



ALL NIPPLES ARE FROM SCHEDULE 80 PIPE

SPECIAL SIZES AVAILABLE

| | CLOSE | 1 1/2" | 2" | 3" | 4" | 5" | 6" |
|--------|-------|--------|-------|-------|-------|-------|-------|
| 1/4" | 13380 | 13381 | 13382 | 13384 | 13386 | 13388 | 13390 |
| 3/8" | 13391 | 13392 | 13393 | 13395 | 13397 | 13399 | 13401 |
| 1/2" | 13403 | 13404 | 13405 | 13407 | 13409 | 13411 | 13413 |
| 3/4" | 13414 | 13415 | 13416 | 13418 | 13420 | 13422 | 13424 |
| 1" | 13425 | - | 13426 | 13428 | 13430 | 13432 | 13434 |
| 1 1/4" | 13435 | - | 13436 | 13438 | 13440 | 13442 | 13444 |
| 1 1/2" | 13445 | - | 13446 | 13448 | 13450 | 13452 | 13454 |
| 2" | 13455 | - | 13456 | 13457 | 13459 | 13461 | 13463 |
| 2 1/2" | 13464 | - | - | 13465 | 13466 | 13467 | 13468 |
| 3" | 13469 | - | - | 13470 | 13471 | 13472 | 13473 |
| 4" | 13474 | - | - | - | 13475 | 13476 | 13477 |

C P V C S C H E D U L E 8 0

D I A M E T E R



L E N G T H



FOR HOT WATER

ALL NIPPLES ARE FROM SCHEDULE 80 PIPE

SPECIAL SIZES AVAILABLE

| | CLOSE | 1 1/2" | 2" | 3" | 4" | 5" | 6" |
|--------|-------|--------|-------|-------|-------|-------|-------|
| 1/4" | 10110 | 10111 | 10112 | 10124 | 10128 | 10130 | 10134 |
| 3/8" | 10147 | 10177 | 13393 | 10187 | 13397 | 10197 | 10202 |
| 1/2" | 10207 | 10210 | 10211 | 10215 | 10218 | 10221 | 10224 |
| 3/4" | 10227 | 10229 | 10230 | 17505 | 17507 | 17510 | 17512 |
| 1" | 17513 | - | 17514 | 17516 | 17518 | 17520 | 17522 |
| 1 1/4" | 10236 | - | 10238 | 10242 | 10245 | 10248 | 10251 |
| 1 1/2" | 10255 | - | 10258 | 10262 | 10272 | 10276 | 10282 |
| 2" | 10288 | - | 10291 | 10293 | 10296 | 10301 | 10304 |

CORZAN HIGH TEMPERATURE PIPING

Specifically targeted for high temperature, small diameter condensate return (CR) lines and industrial drainage systems. Safely handles hot corrosives where operating conditions exceed the temperature limitations of standard CPVC. CR system (complete with quality fittings and solvent cements) provides a tough alternative to carbon steel and other metallic systems.

Temperatures up to 215°F. Exceptional corrosion resistance provides a tough alternative for many systems that are too aggressive for metallics. Typical usage, hot caustics and acids typically found in food-processing operations, metal treating/electroplating facilities, pulp and paper mills, chemical manufacturing industries, and water and waste-water treatment facilities.

Ideal for low pressure/drainage applications involving hot chemical service. Maximum pressure rating of 15 psi @

215°F.

Detailed installation information is available from our experts.

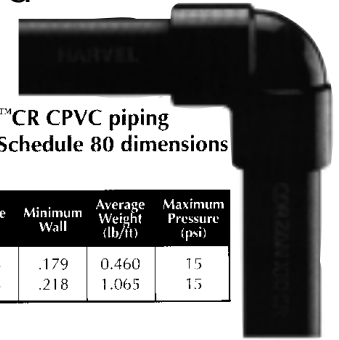

Harvel Corzan X10™ CR CPVC piping is produced to IPS Schedule 80 dimensions per ASTM F441

| Nominal Pipe Size (in.) | Average O.D. | Average I.D. | Minimum Wall | Average Weight (lb/ft) | Maximum Pressure (psi) |
|-------------------------|--------------|--------------|--------------|------------------------|------------------------|
| 1 | 1.315 | 0.935 | .179 | 0.460 | 15 |
| 2 | 2.375 | 1.913 | .218 | 1.065 | 15 |

Harvel Corzan X10™ CR Maximum Support Spacing (ft)

| Nominal Pipe Size (in.) | Temperature F | | | | | | | |
|-------------------------|---------------|-----|-------|-----|-------|-------|-------|-------|
| | 73 | 100 | 120 | 140 | 160 | 180 | 200 | 215 |
| 1 | 6 | 6 | 5 1/2 | 5 | 3 1/2 | 3 | 2 1/2 | 2 1/2 |
| 2 | 7 | 7 | 6 1/2 | 6 | 4 | 3 1/2 | 3 1/2 | 3 |

Chart for support spacing for continuous spans of uninsulated lines carrying fluids with a specific gravity up to 1.00

FITTINGS AVAILABLE: 90° Elbow, 45° Elbow, Coupling, Male Adapter, Tees, Reducer Bushings.

CLEAR RIGID SCHEDULE 40 PVC PIPE AND FITTINGS

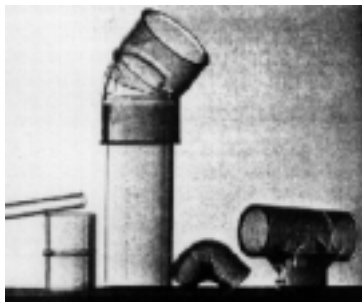

Made from a clear rigid compound to permit visual contact with the flow.
 Made from non-toxic ingredients conforming to FDA standard for use with food contact surfaces.
 Smooth pipe interior surface provides excellent flow char?
 Flame retardant; non-conductive
 Quick and easy glue-on installation with primer, cleaner
 Manufactured to schedule 40 dimensions allowing use in schedule 40 installation
 Fittings may be COLD sterilized in Ethylene Oxide
 10 foot length pipe
 Fittings: 90° ell, tees, couplings, male adapters, female adapters, 1/2" to 2": cement, cleaner
 Threading not recommended.

APPLICATIONS

Sight gauges, wet or dry food processing, beverage transmission and processing, laboratories, pharmaceutical manufacture, chemical processing, photofinishing, hospitals, electroplating, dairy processing.

ALL FITTINGS AVAILABLE!

PIPE

| NOM PIPE SIZE | FIG. NO. | ID (IN) | OD (IN) | MAX WORKING PSI AT 70°F |
|---------------|----------|---------|---------|-------------------------|
| 1/4 | 48636 | .346 | .540 | 390 |
| 3/8 | 48637 | .473 | .675 | 310 |
| 1/2 | 48638 | .602 | .840 | 300 |
| 3/4 | 48639 | .804 | 1.050 | 240 |
| 1 | 48640 | 1.029 | 1.315 | 220 |
| 1 1/4 | 48641 | 1.360 | 1.660 | 180 |
| 1 1/2 | 48642 | 1.590 | 1.900 | 170 |
| 2 | 48643 | 2.047 | 2.375 | 140 |
| 3 | 48644 | 3.042 | 3.500 | 130 |
| 4 | 48645 | 3.998 | 4.500 | 110 |
| 6 | 48646 | 6.375 | 6.625 | 45 |

LAB FITTINGS, SINKS AND COUNTER TOPS

DEIONIZED WATER CORROSIVE ATMOSPHERES DEMINERALIZED WATER DISTILLED WATER

| SIZE | FIG. NO. | PRICE |
|------|----------|-------|
|------|----------|-------|

UNIVERSAL LAB COCK

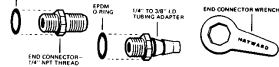

Adapts to F X F, F X M, F X HOSE, M X M, M X HOSE AND HOSE X HOSE configurations!

1/4" 33458

CONTROLLED FLO PLASTIC LAB FIXTURE

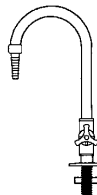

Polyvinyl chloride service fixtures with special molded needle valve near the base of the fixture for fine adjustments of fluids.

These fixtures are compatible with all laboratory service lines, and are resistant to internal and environmental corrosion, abrasion and leaching in the presence of high purity distilled and demineralized waters. They are produced in standard 3/8" NPT size and are compatible with all conventional services, including water, all gases hot and hot water, vacuum and etc.

PVC 28352
POLY PRO 28353

REMOTE LAB FAUCET - PVC

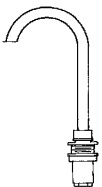

Fig. No. 28358

POLYPROPYLENE LABORATORY SINKS



| SIZE | FIG. NO. | PRICE |
|------|----------|-------|
|------|----------|-------|

LABCOCK FEMXBARB



1/4 FEM X 1/4 BARB
Precise fingertip control
Perfect for laboratory use

1/4 52559

LAB FAUCET - PVC

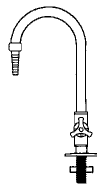

Deck mount

28357

PANEL MOUNT LAB FAUCET PVC

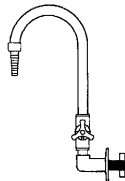

POLYPROPYLENE CUP SINKS

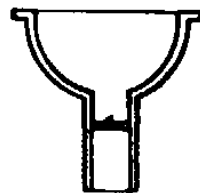

| SIZE | FIG. NO. | PRICE |
|------|----------|-------|
|------|----------|-------|

9X3"

6X3"

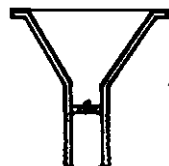

7"

WE CAN FABRICATE OR BUILD ANY LABORATORY TOP, SINK OR COUNTER!

| SIZE | FIG. NO. | PRICE |
|------|----------|-------|
|------|----------|-------|

TANK FITTINGS

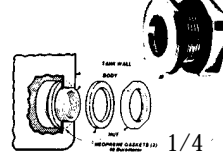

| | |
|-------|-------|
| 1/4 | 15958 |
| 3/8 | 15960 |
| 1/2 | 15962 |
| 3/4 | 15964 |
| 1 | 15965 |
| 1 1/4 | 15967 |
| 1 1/2 | 15969 |
| 2 | 15970 |

HEAVY DUTY BULKHEAD FITTING



| S | L | I | P | X | F | P | T |
|---|---|---|---|---|---|---|---|
|---|---|---|---|---|---|---|---|

| | |
|-------|---------|
| 1/2 | 871-005 |
| 3/4 | 871-007 |
| 1 | 871-010 |
| 1 1/4 | 871-012 |
| 1 1/2 | 871-015 |
| 2 | 871-020 |
| 3 | 871-030 |
| 4 | 871-040 |
| 6 | 871-060 |

| F | P | T | X | F | P | T |
|---|---|---|---|---|---|---|
|---|---|---|---|---|---|---|

| | |
|-------|---------|
| 1/2 | 872-005 |
| 3/4 | 872-007 |
| 1 | 872-010 |
| 1 1/4 | 872-012 |
| 1 1/2 | 872-015 |
| 2 | 872-020 |
| 3 | 872-030 |
| 4 | 872-040 |
| 6 | 872-060 |

BOTTLE DRAIN

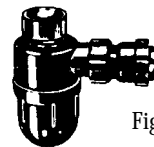

Fig. No. 36473

SINK WASTE FITTING



Complete with locknut, plug and strainer.

Fig. No. 19759

CHEMICAL RESISTANT DRAIN & HIGH PURTY PIPE SYSTEMS

Mechanical Joint
Polypropylene

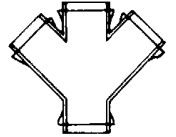
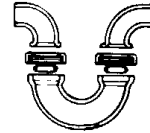
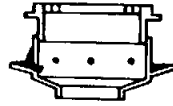
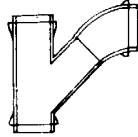
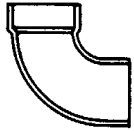

Mechanical joint from 1 1/2" - 6"

Fusion Joint Style

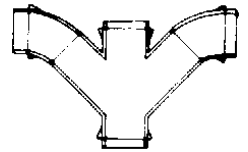
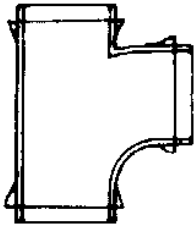

Enfield

Chemtrol®



POLYPROPYLENE HIGH PURITY WATER SYSTEM
SOCKET & BUTT FUSION SYSTEM

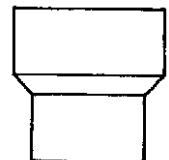
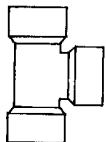
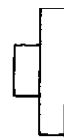
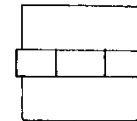
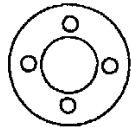
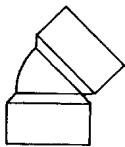

ALL AVAILABLE FOR QUICK SHIPMENT

THERMOPLASTIC WELDING

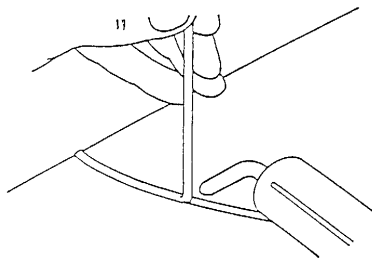
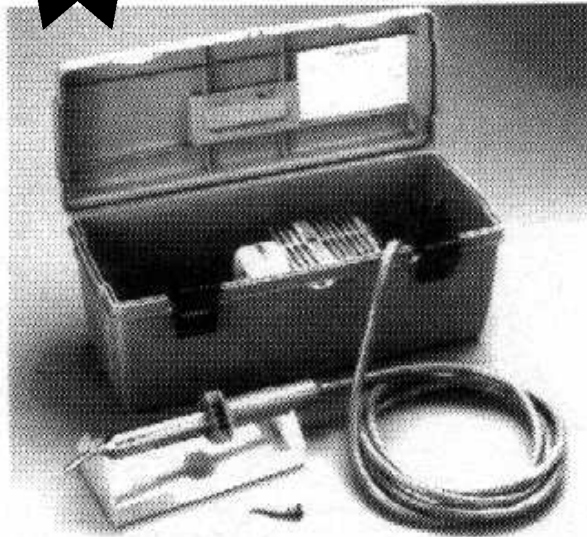

Duff 120V super plastic welder kit. This is a complete plastics welding kit for production and general use. Features a cooler barrel which reduces the risk of injury. This welder features adjustable heat control. Kit contains the welder, one tacking tip, one round tip, air compressor and carrying case.

It is possible to weld most thermoplastic material, that can be softened or shaped by heat, with a Duff electric hot air welder. This lightweight, hand held unit makes it easy for even the inexperienced user to develop the 'feel;' for welding plastic and doing it economically and with speed after only a few hours of study and practice. Whether fabricating thermoplastic stock or repairing various types of plastic parts, hot air welding is usually performed on plastics with at thickness of 1/16 inch, or more. The bond achieved, depending on the type of weld, is generally as strong (90% or more) as the original material. Duff hot air welding equipment is specially designed for extensive hand-held use without causing operator fatigue. The equipment is light and very maneuverable. It can be moved easily from one project work area to another. All that is needed is a concentrated effort to learn about the use of the equipment.

CALL FOR PRICING AND AVAILABILITY!

WELDING ROD

PVC WELDING ROD

Available in either a round or triangular cross section, white or gray color, in straight lengths 48" long.

CPVC WELDING ROD

Available in either a round or triangular cross section in 48" lengths. Its light gray color matches the CPVC sheet.

| DESCRIPTION | ROUND | | TRIANGULAR | | PRICE |
|-----------------|-------------|---------|-------------|---------|-------|
| | FIG. NO. | FT./LB. | FIG. NO. | FT./LB. | |
| PVC 1/8" Gray | DRH1800-004 | 124 | DRH1800-014 | 114 | |
| PVC 5/32" Gray | DRH1800-005 | 84 | DRH1800-015 | 65 | |
| PVC 3/16" Gray | DRH1800-006 | 62 | DRH1800-016 | 50 | |
| PVC 1/8" White | DRH1800-104 | 124 | DRH1800-114 | 114 | |
| PVC 5/32" White | DRH1800-105 | 84 | DRH1800-115 | 65 | |
| PVC 3/16" White | DRH1800-106 | 62 | DRH1800-116 | 50 | |
| PVC 1/8" Clear | DRH1800-204 | 140 | DRH1800-214 | 110 | |
| PVC 5/32" Clear | DRH1800-205 | 90 | DRH1800-215 | 60 | |
| PVC 3/16" Clear | DRH1800-206 | 62 | DRH1800-216 | 53 | |
| PVC 1/8" Blue | DRH1800-304 | 124 | - | - | |
| PVC 5/32" Blue | DRH1800-305 | 84 | - | - | |
| CPVC 1/8" | DRH1808-004 | 112 | DRH1808-014 | 118 | |
| CPVC 5/32" | DRH1808-005 | 77 | DRH1808-015 | 75 | |
| CPVC 3/16" | DRH1808-006 | 56 | DRH1808-016 | 52 | |

SOLD BY THE POUND

PVC DRAIN WASTE VENT FITTINGS

| | SIZE | FIG. NO. | PRICE |
|---|-------|----------|-------|
|  | 1 1/4 | 10473 | |
| | 1 1/2 | 10480 | |
| | 2 | 10488 | |
| | 3 | 10489 | |
| | 4 | 10494 | |
| | 6 | 10498 | |

| | SIZE | FIG. NO. | PRICE |
|---|-------|----------|-------|
|  | 1 1/2 | 10507 | |
| | 2 | 10508 | |
| | 3 | 10518 | |
| | 4 | 10528 | |

| | SIZE | FIG. NO. | PRICE |
|---|---------|----------|-------|
|  | 2X1 1/2 | 10501 | |
| | 3X1 1/2 | 17799 | |
| | 3X2 | 17800 | |
| | 4X2 | 17802 | |
| | 4X3 | 17801 | |

| | SIZE | FIG. NO. | PRICE |
|--|---------------|----------|-------|
|  | 1 1/2 X 1 1/4 | 10530 | |
| | 2X13 | 18037 | |
| | 2X12 | 10533 | |
| | 3X12 | 10538 | |
| | 3X2 | 10546 | |
| | 4X2 | 10551 | |
| | 4X3 | 10554 | |
| 6X4 | 20102 | | |

| | SIZE | FIG. NO. | PRICE |
|---|---------------|----------|-------|
|  | 1 1/4 | 10571 | |
| | 1 1/2 | 10573 | |
| | 2 | 10576 | |
| | 3 | 10580 | |
| | 4 | 10582 | |
| | 1 1/2 X 1 1/4 | 24827 | |

| | SIZE | FIG. NO. | PRICE |
|---|-------|----------|-------|
|  | 1 1/4 | 10555 | |
| | 1 1/2 | 10559 | |
| | 2 | 10562 | |
| | 3 | 10565 | |
| | 4 | 10567 | |
| | 6 | 10569 | |

| | SIZE | FIG. NO. | PRICE |
|---|-------|----------|-------|
|  | 1 1/2 | 10636 | |
| | 2 | 10639 | |
| | 3 | 10643 | |
| | 4 | 10650 | |
| | 6 | 10654 | |
| | 8 | 49125 | |

| | SIZE | FIG. NO. | PRICE |
|---|-------|----------|-------|
|  | 1 1/2 | 10658 | |
| | 2 | 10663 | |
| | 3 | 10665 | |
| | 4 | 10675 | |
| | 6 | 10679 | |
| | 8 | 53624 | |

| | SIZE | FIG. NO. | PRICE |
|---|-------|----------|-------|
|  | 1 1/2 | 10332 | |
| | 2 | 10334 | |
| | 3 | 10336 | |
| | 4 | 10338 | |
| | 6 | 48877 | |

| | SIZE | FIG. NO. | PRICE |
|---|-------|----------|-------|
|  | 1 1/4 | 10277 | |
| | 1 1/2 | 10281 | |
| | 2 | 10284 | |
| | 3 | 10286 | |
| | 4 | 10289 | |
| | 6 | 10292 | |

| | SIZE | FIG. NO. | PRICE |
|--|-------|----------|-------|
|  | 1 1/4 | 10297 | |
| | 1 1/2 | 10302 | |
| | 2 | 10306 | |
| | 3 | 10309 | |
| | 4 | 10311 | |
| | 6 | 10314 | |

| | SIZE | FIG. NO. | PRICE |
|---|-------|----------|-------|
|  | 1 1/2 | 10321 | |
| | 2 | 10323 | |
| | 3 | 10325 | |
| | 4 | 10327 | |

| | SIZE | FIG. NO. | PRICE |
|---|-------|----------|-------|
|  | 1 1/4 | 10138 | |
| | 1 1/2 | 10140 | |
| | 2 | 10141 | |
| | 3 | 10142 | |
| | 4 | 10143 | |
| | 6 | 10144 | |

| | SIZE | FIG. NO. | PRICE |
|---|-------|----------|-------|
|  | 1 1/4 | 10145 | |
| | 1 1/2 | 10146 | |
| | 2 | 10180 | |
| | 3 | 10192 | |
| | 4 | 10196 | |
| | 6 | 10201 | |

| | SIZE | FIG. NO. | PRICE |
|---|-----------|----------|-------|
|  | 3X3X1 1/2 | 10206 | |
| | 3X3X2 | 10274 | |

| | SIZE | FIG. NO. | PRICE |
|---|-----------|----------|-------|
|  | 3X3X1 1/2 | 18327 | |
| | 3X3X2 | 18328 | |

| | SIZE | FIG. NO. | PRICE |
|---|-----------|----------|-------|
|  | 1 1/4 | 10399 | |
| | 1 1/2 | 10422 | |
| | 2 | 10430 | |
| | 3 | 10433 | |
| | 4 | 10436 | |
| | 6 | 10438 | |
| | 2X2X1 1/2 | 17844 | |
| | 3X3X1 1/2 | 10443 | |
| | 3X3X2 | 10447 | |
| | 4X4X2 | 10460 | |
| 4X4X3 | 10457 | | |
| 6X6X4 | 10470 | | |

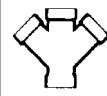
| | SIZE | FIG. NO. | PRICE |
|---|---------|----------|-------|
|  | 1 1/2 | 23970 | |
| | 2 | 23971 | |
| | 3 | 23972 | |
| | 4 | 21051 | |
| | 3X3X2X2 | 29512 | |
| | 4X4X2X2 | 20760 | |

| | SIZE | FIG. NO. | PRICE |
|---|-----------------|----------|-------|
|  | 1 1/2 | 29499 | |
| | 2 | 29500 | |
| | 3 | 29502 | |
| | 2x1 1/2 x 1 1/2 | 29501 | |

| | SIZE | FIG. NO. | PRICE |
|---|-------|----------|-------|
|  | 1 1/2 | 38607 | |
| | 2 | 38608 | |
| | 3 | 38609 | |
| | 4 | 38610 | |

| | SIZE | FIG. NO. | PRICE |
|---|-----------------|----------|-------|
|  | 1 1/4 | 10349 | |
| | 1 1/2 | 10351 | |
| | 2 | 10352 | |
| | 3 | 10355 | |
| | 4 | 10357 | |
| | 6 | 38600 | |
| | 2x1 1/2 x 1 1/2 | 29505 | |
| | 2X1 1/2 X 2 | 29507 | |
| | 2X2X1 1/2 | 10367 | |
| | 3X3X1 1/2 | 10371 | |
| | 3X3X2 | 10374 | |
| | 4X4X2 | 10380 | |
| | 4X4X3 | 10381 | |
| | 6X4 | 42479 | |

FOR DWV PIPE - SEE PAGE 581

PVC DRAIN WASTE VENT FITTINGS CONT'D

| SIZE | FIG. NO. | PRICE |
|------|----------|-------|
|------|----------|-------|

SANITARY TEE (SpXHXH)



| | |
|---|-------|
| 3 | 63382 |
| 4 | 63383 |

DOUBLE SANITARY TEE HXHXHXH

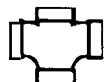

| | |
|-------|-------|
| 1 1/2 | 10382 |
| 2 | 10384 |
| 3 | 10387 |
| 4 | 10389 |

2 X 2 X 1 1/2 X 1 1/2 18329

3 X 3 X 1 1/2 X 1 1/2 18330

3 X 3 X 2 X 2 18331

4 X 4 X 2 X 2 18332

4 X 4 X 3 X 3 18333

P TRAP LA PATTERN W/ UNION SLIPXH



| | |
|-------|-------|
| 1 1/2 | 10896 |
|-------|-------|

PTRAP W/ UNION HXH



| | |
|-------|-------|
| 1 1/4 | 40050 |
|-------|-------|

PTRAP W/ SOLVENT WELD JOINT HXH



| | |
|-------|-------|
| 1 1/2 | 68193 |
| 2 | 68194 |
| 3 | 68195 |
| 4 | 10891 |

PTRAP U-BEND HXH



| | |
|-------|-------|
| 1 1/2 | 10683 |
| 2 | 10698 |
| 3 | 10701 |

DRUM TRAP HXH



| | |
|-----------|-------|
| 3X6X1 1/2 | 10899 |
|-----------|-------|

TRAP ADAPTER Female w/ self sealing nut (HXSLIP)



| | |
|-------------|-------|
| 1 1/2 | 10584 |
| 1 1/2x1 1/4 | 10588 |

TRAP ADAPTER Male w/ washer & nut (SpgXSlip)



| | |
|-------------|-------|
| 1 1/2 | 10591 |
| 1 1/2x1 1/4 | 10594 |

| SIZE | FIG. NO. | PRICE |
|------|----------|-------|
|------|----------|-------|

CLOSET FLANGE



| | |
|---------|-------|
| 4 Hub | 10916 |
| 4x3 Hub | 10913 |

CLOSET FLANGE HUB END



| | |
|-----|-------|
| 4X3 | 10920 |
|-----|-------|

CLOSET FLANGE W/ ADJUSTABLE RING



| | |
|-----|-------|
| 4X3 | 10924 |
|-----|-------|

OFFSET CLOSET FLANGE W/ Adjustable metal ring (Hub)



| | |
|-----|-------|
| 4x3 | 10893 |
|-----|-------|

HUB ADAPTER Cast Iron (Adapts DWV Spigot to Cast Iron Hub) (HxSpg)



| | |
|-----------|-------|
| 2 | 10613 |
| 3 | 10632 |
| 4 | 10634 |
| 1 1/2X2CI | 18041 |
| 3X4CI | 10630 |

ADAPTER COUPLING (Adapts Sewer & Drain Spigot to DWV Spigot) (HxH)



| | |
|-----|-------|
| 4x3 | 29528 |
|-----|-------|

MULTI-USE COUPLING



| | |
|------------|-------|
| 2" into 3" | 59681 |
| 3" into 4" | 59682 |

4" CAST IRON CLOSE FLANGE REPLACEMENT

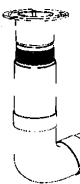

PVC. Up to 3" of adjustment to riser compression joint. Slides inside 4" cast iron and sch. 40 ABS and PVC. No need to remove leaded joint. No tearing up of floors. No caulking of lead joint. Just lip into pipe and tighten 3 stainless steel bolts. Breat for new concrete construction. Can be used with 4" heavy duty service weight or no hub cast iron.

| | |
|----|-------|
| 4" | 48455 |
|----|-------|

| SIZE | FIG. NO. | PRICE |
|------|----------|-------|
|------|----------|-------|

PVC SADDLE TEE

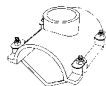

| | |
|-----|-------|
| 3X2 | 15807 |
| 4X2 | 15809 |
| 4X3 | 50405 |
| 4X4 | 15810 |

4" PVC BACKWATER VALVE



| | |
|---|-------|
| 4 | 15819 |
|---|-------|

GENERAL PURPOSE STRAINER for use in concrete, terrazzo and ceramic tile.



| | |
|---|-------|
| 2 | 15760 |
| 3 | 15762 |
| 4 | 15768 |

PVC SHOWER DRAIN

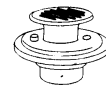

| | |
|-------------------------|-------|
| fits both 2" and 3" PVC | 42033 |
|-------------------------|-------|

PVC DOME ROOF DRAIN



| | |
|---|-------|
| 3 | 15788 |
| 4 | 15790 |

PVC FLOOR DRAIN

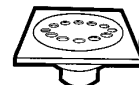

| | |
|-------------------|-------|
| 6X6 (1 1/2" & 2") | 15777 |
| 9X9 (3") | 15780 |

DRAIN PIPE "J" HOOK

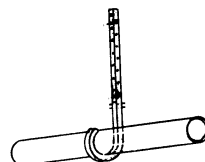

| | |
|-------|-------|
| 1/2 | 15974 |
| 3/4 | 15976 |
| 1 | 15977 |
| 1 1/4 | 15978 |
| 1 1/2 | 15980 |
| 2 | 15981 |
| 3 | 15983 |
| 4 | 15985 |

PVC GRATE FLOOR DRAIN 4"

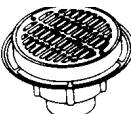



| |
|-------|
| 15785 |
|-------|

SEWER & DRAIN FITTINGS

| | SIZE | FIG. NO. | PRICE |
|--|------|----------|-------|
| STRAIGHT TEE  | 3 | 11301 | |
| | 4 | 11313 | |
| | 6 | 11314 | |

| | SIZE | FIG. NO. | PRICE |
|--|------|----------|-------|
| SANITARY TEE  | 3 | 11312 | |
| | 4 | 11313 | |
| | 6 | 11314 | |
| | 6X4 | 11315 | |

| | SIZE | FIG. NO. | PRICE |
|---|------|----------|-------|
| TEE-CROSS  | 4 | 11317 | |

| | SIZE | FIG. NO. | PRICE |
|--|------|----------|-------|
| 1/4 BEND  | 3 | 11319 | |
| | 4 | 73691 | |
| | 6 | 11323 | |

| | SIZE | FIG. NO. | PRICE |
|--|------|----------|-------|
| 1/4 BEND LONG TURN  | 3 | 63452 | |
| | 4 | 63453 | |
| | 6 | 63454 | |
| | 8 | 63456 | |

| | SIZE | FIG. NO. | PRICE |
|---|------|----------|-------|
| 1/4 STREET BEND LONG TURN  | 3 | 11324 | |
| | 4 | 11325 | |
| | 6 | 11326 | |

| | SIZE | FIG. NO. | PRICE |
|---|------|----------|-------|
| 45° WYE  | 3 | 11327 | |
| | 4 | 11328 | |
| | 6 | 11329 | |
| | 6X4 | 11330 | |

| | SIZE | FIG. NO. | PRICE |
|---|------|----------|-------|
| 1/8 STREET BEND  | 3 | 11396 | |
| | 4 | 11400 | |
| | 6 | 11405 | |

| | SIZE | FIG. NO. | PRICE |
|--|------|----------|-------|
| 1/8 BEND  | 3 | 11331 | |
| | 4 | 11332 | |
| | 6 | 11333 | |

| | SIZE | FIG. NO. | PRICE |
|--|------|----------|-------|
| COUPLING  | 3 | 11334 | |
| | 4 | 11335 | |
| | 6 | 11336 | |

| | SIZE | FIG. NO. | PRICE |
|--|------|----------|-------|
| DWV COUPLING  | 4X4 | 11340 | |
| | 6X4 | 11343 | |

| | SIZE | FIG. NO. | PRICE |
|--|------|----------|-------|
| REDUCER COUPLING  | 4X3 | 11337 | |
| | 6X4 | 11338 | |

| | SIZE | FIG. NO. | PRICE |
|---|------|----------|-------|
| DRAIN GRATE  | 3 | 11345 | |
| | 4 | 11346 | |
| | 6 | 11347 | |

| | SIZE | FIG. NO. | PRICE |
|--|------|----------|-------|
| FEMALE ADAPTER  | 3 | 40025 | |
| | 4 | 40026 | |
| | 6 | 40027 | |

| | SIZE | FIG. NO. | PRICE |
|--|------|----------|-------|
| FITTING CLEANOUT  | 4 | 11375 | |
| | 6 | 47656 | |

| | SIZE | FIG. NO. | PRICE |
|---|------|----------|-------|
| CAP  | 3 | 11381 | |
| | 4 | 11383 | |
| | 6 | 11385 | |

| | SIZE | FIG. NO. | PRICE |
|---|------|----------|-------|
| 1/16 BEND  | 3 | 11411 | |
| | 4 | 11415 | |
| | 6 | 19952 | |

| | SIZE | FIG. NO. | PRICE |
|---|-------|----------|-------|
| DOWNSPOUT ADAPTER  | 2X3X3 | 11387 | |
| | 2X3X4 | 11388 | |
| | 3X4X3 | 11391 | |
| | 3X4X4 | 11394 | |

| | SIZE | FIG. NO. | PRICE |
|--|--------|----------|-------|
| SADDLE TEE  | 4 ON 6 | 45167 | |
| | 6 ON 8 | 45168 | |

| | SIZE | FIG. NO. | PRICE |
|--|--------|----------|-------|
| SADDLE WYE  | 4 ON 6 | 45169 | |
| | 6 ON 8 | 45170 | |

| | SIZE | FIG. NO. | PRICE |
|--|--------------|----------|-------|
| VENT CAP PVC  | Fits 3" & 4" | 15815 | |

S&D PIPE
10Foot Lengths

| SOLID | | |
|-------|----------|-------|
| SIZE | FIG. NO. | PRICE |
| 3" | 11484 | |
| 4" | 11486 | |
| 6" | 11487 | |

| PERFORATED | | |
|------------|----------|-------|
| SIZE | FIG. NO. | PRICE |
| 3" | 11483 | |
| 4" | 11485 | |
| 6" | 41951 | |

| PVC FLOOR SINK | | |
|---|----------|-------|
|  | FIG. NO. | PRICE |
| 3" Sch 40 outlet | 60980 | |

| PVC ADJUSTABLE URINAL FLANGE | | |
|---|----------|-------|
|  | FIG. NO. | PRICE |
| | 15757 | |

DUFF IS ALWAYS
ON
CALL!

365 DAYS A YEAR

24 HOUR
EMERGENCY SERVICE!

610-275-4453

SDR 35 GASKETED FITTINGS & PIPE

| | SIZE | FIG. NO. | PRICE |
|---|------|----------|-------|
|  | 4 | 11693 | |
| | 6 | 11698 | |
| | 6X4 | 11695 | |
| | 8 | 11707 | |
| | 8X4 | 11700 | |
| | 8X6 | 11703 | |
| | 10 | 11717 | |
| | 12 | 19967 | |

| | SIZE | FIG. NO. | PRICE |
|---|------|----------|-------|
|  | 4 | 49338 | |

| | SIZE | FIG. NO. | PRICE |
|---|------|-------------------|-------|
|  | 4 | 11891 | |
| | 6 | 11902 | |
| | 6X4 | 11895 | |
| | 8 | CALL FOR PRICING! | |
| | 8X4 | 11907 | |
| | 8X6 | 11914 | |
| | 10X6 | 11925 | |

| | SIZE | FIG. NO. | PRICE |
|---|------|-------------------|-------|
|  | 4 | 52445 | |
| | 6 | 52446 | |
| | 8 | CALL FOR PRICING! | |

| | SIZE | FIG. NO. | PRICE |
|---|------|----------|-------|
|  | 4 | 11654 | |
| | 6 | 11660 | |
| | 8 | 11664 | |
| | 10 | 11669 | |

| | SIZE | FIG. NO. | PRICE |
|---|------|----------|-------|
|  | 4 | 11671 | |
| | 6 | 11674 | |
| | 8 | 11676 | |
| | 10 | 11679 | |
| | 12 | 19966 | |

| | SIZE | FIG. NO. | PRICE |
|---|------|----------|-------|
|  | 4 | 11793 | |
| | 6 | 11801 | |
| | 6X4 | 11797 | |
| | 8 | 11819 | |
| | 8X4 | 11808 | |
| | 8X6 | 11814 | |
| | 10X8 | 11842 | |
| | 10X6 | 11834 | |
| | 10X4 | 11822 | |
| | 10 | 11847 | |

| | SIZE | FIG. NO. | PRICE |
|---|------|----------|-------|
|  | 4 | 11641 | |
| | 6 | 11645 | |
| | 8 | 11648 | |
| | 10 | 11651 | |
| | 12 | 19964 | |

| | SIZE | FIG. NO. | PRICE |
|---|------|----------|-------|
|  | 4 | 11617 | |
| | 6 | 11631 | |
| | 8 | 11634 | |
| | 10 | 11638 | |
| | 12 | 19963 | |

| | SIZE | FIG. NO. | PRICE |
|---|------|----------|-------|
|  | 4 | 11727 | |
| | 6 | 11730 | |
| | 8 | 11731 | |
| | 10 | 11733 | |
| | 12 | 19969 | |

| | SIZE | FIG. NO. | PRICE |
|--|------|----------|-------|
|  | 4 | 11737 | |
| | 6 | 11740 | |
| | 8 | 11777 | |
| | 10 | 11787 | |
| | 12 | 19970 | |

| | SIZE | FIG. NO. | PRICE |
|---|------|----------|-------|
|  | 4X4 | 19979 | |
| | 6X6 | 19980 | |

| | SIZE | FIG. NO. | PRICE |
|---|------|----------|-------|
|  | 4 | 11719 | |
| | 6 | 11720 | |

| | SIZE | FIG. NO. | PRICE |
|---|------|----------|-------|
|  | 4X4 | 50440 | |

| | SIZE | FIG. NO. | PRICE |
|---|------|----------|-------|
|  | 6X4 | 11955 | |
| | 8X4 | 11961 | |

| | SIZE | FIG. NO. | PRICE |
|---|------|----------|-------|
|  | 4 | 11682 | |
| | 6 | 11685 | |
| | 8 | 11688 | |
| | 10 | 11690 | |
| | 12 | 19968 | |

| | SIZE | FIG. NO. | PRICE |
|---|------|----------|-------|
|  | 4 | 19958 | |
| | 6 | 19959 | |
| | 8 | 19960 | |

SDR 35 PIPE
GASKETED SEWER MAIN
12 1/2' LENGTH



SDR 35 IS AVAILABLE UP TO 24"

| NOMSIZE | FIG. NO. | PRICE |
|---------|----------|-------|
| 4" | 11488 | |
| 6" | 11489 | |
| 8" | 11490 | |
| 10" | 11491 | |
| 12" | 19433 | |

ASTMD3034 SDR-35

| NOM PIPE SIZE (IN.) | OD (IN.) | WALL (IN.) |
|---------------------|----------|------------|
| 4" | 4.215 | .125 |
| 6" | 6.275 | .180 |
| 8" | 8.400 | .240 |
| 10" | 10.500 | .300 |
| 12" | 12.500 | .360 |
| 15" | 15.300 | .437 |
| 18" | 18.701 | .536 |
| 21" | 22.047 | .632 |
| 24" | 24.803 | .711 |

CORRUGATED PIPE AND FITTINGS

| SIZE | FIG. NO. | PRICE |
|--|----------|-------|
| PERFORATED TUBING for foundations & field drainage | | |
|  3x100' | 41224 | |
| 3x300' | 47666 | |
| 4x100' | 15302 | |
| 4x250' | 15305 | |
| 6x100' | 15307 | |

| SIZE | FIG. NO. | PRICE |
|--|----------|-------|
| NON-PERFORATED TUBING for downspout & root areas. SOLID. | | |
|  3x100' | 41225 | |
| 3x300' | 47667 | |
| 4x100' | 15299 | |
| 4x250' | 15303 | |
| 6x100' | 15306 | |
| 8x20 | 20830 | |
| 10x20 | 26455 | |
| 12x20 | 26456 | |

| SIZE | FIG. NO. | PRICE |
|---|----------|-------|
| CORRUGATED 90° ELL | | |
|  4 | 15309 | |

| SIZE | FIG. NO. | PRICE |
|---|----------|-------|
| CORRUGATED SNAP TEE | | |
|  4 | 15310 | |
| 6 | 38614 | |

| SIZE | FIG. NO. | PRICE |
|---|----------|-------|
| CORRUGATED DOWNSPOUT ADAPTER | | |
|  4 | 26336 | |

| SIZE | FIG. NO. | PRICE |
|---|----------|-------|
| CORRUGATED SPLIT END CAP | | |
|  4 | 15308 | |
| 6 | 38613 | |

| SIZE | FIG. NO. | PRICE |
|---|----------|-------|
| CORRUGATED SPLIT COUPLING | | |
|  4 | 15312 | |
| 6 | 38616 | |

| SIZE | FIG. NO. | PRICE |
|---|----------|-------|
| CORRUGATED 45° "Y" | | |
|  4 | 15311 | |
| 6 | 38615 | |

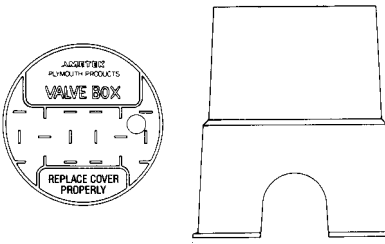

VALVE BOXES AND ENCLOSURES

| FIG. NO. | PRICE |
|---|-------|
| ECONOMY TURF BOX | |
|  | |
| 15833 | |

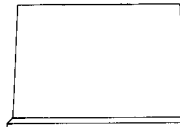
| FIG. NO. | PRICE |
|---|-------|
| TURF BOX EXTENSION | |
|  | |
| 69252 | |

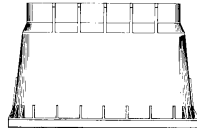
| FIG. NO. | PRICE |
|--|-------|
| 12" STANDARD METER BOX WITH LID | |
|  | |
| 15832 | |

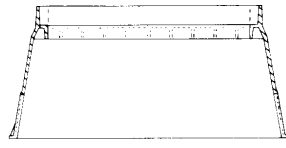
| FIG. NO. | PRICE |
|---|-------|
| 12" JUMBO METER BOX WITH LID | |
|  | |
| 15832 | |

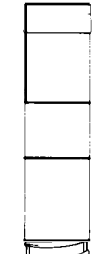
| FIG. NO. | PRICE |
|---|-------|
| PVC EXTENSION CURB BOX 30X48 | |
|  | |
| 15828 | |

CALL DUFF FIRST FOR ALL YOUR IRRIGATION NEEDS!
610-275-4453

| FIG. NO. | PRICE |
|--|-------|
| 6" STANDARD METER BOX EXTENSION | |
|  | |
| 48997 | |

| FIG. NO. | PRICE |
|---|-------|
| 6" JUMBO METER BOX EXTENSION | |
|  | |
| 48992 | |

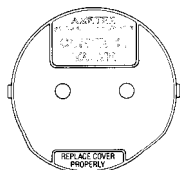
| FIG. NO. | PRICE |
|--|-------|
| 10" CIRCULAR BOX WITH LID | |
|  | |
| 15830 | |

For additional information call: 610-275-4453 or Fax: 610-279-6299
Please call for current prices.

NDS SURFACE DRAIN PRODUCTS

SPEE-D BASINS AND GRATES

NDS catch basins have a sump area that collects debris, preventing clogging of the pipeline. Grates are available in a variety of colors to blend in with surrounding surfaces. Depending on the size of the round, square or atrium grates, they may fit directly into riser of pipe, sewer and drain fitting or our catch basins. (Refer to our catalog for the size of pipe, fittings or catch basins that each grate fits.) Popular applications for our grates include:

- Round grates for landscaping
- Square grates for brick, masonry, concrete, asphalt applications
- Atrium grates for landscaping, window wells or where a flat grate may clog with leaves or mulch.

SPEE-D-BASIN

| | |
|-------------------|-----------|
| Single Outlet | 101-Black |
| Double Outlet | 201-Black |
| Double 90° Outlet | 250-Black |
| 3 Way Outlet * | 300-Black |
| 4 Way Outlet * | 350-Black |

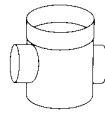

#101, #201 Outlets fit 3" or 4" Sewer and Drain Pipe, 3" or 4" Corrugated Pipe, or 4" DWV Pipe.

#250, #300, #350 Outlets fit 4" Sewer and Drain Pipe, 3" or 4" Corrugated Pipe, or 4" DWV Pipe

* Also Fits 4" Sewer and Drain Fittings.

ROUND GRATES

| | | |
|---------------------|-----------------------------|------------|
| 10" ROUND | 10" Grate Fits | 1040-Black |
| | 8" Sewer and Drain Fittings | 1050-Green |
| | 8" Corrugated Pipe | 1060-Grey |
| | 8" Sewer and Drain Pipe | |
| 8" ROUND | 8" Grate Fits SPEE-D Basin | 10-Black |
| | 6" Sewer and Drain Fittings | 20-Green |
| | 6" Corrugated Pipe | 30-Grey |
| 6" ROUND | 6" Grate Fits SPEE-D Basin | 40-Black |
| | 6" Sewer and Drain Fittings | 50-Green |
| | 6" Corrugated Pipe | 60-Grey |
| | 6" Sewer and Drain Pipe | |
| 4" ROUND | 4" Grate Fits | 11-Black |
| | 4" Sewer and Drain Fittings | 12-Grey |
| | 4" Corrugated Pipe | 13-Green |
| 3" ROUND | 3" Grate Fits | 14-Black |
| | 3" Sewer and Drain Fittings | 15-Grey |
| | 3" Corrugated Pipe | 16-Green |

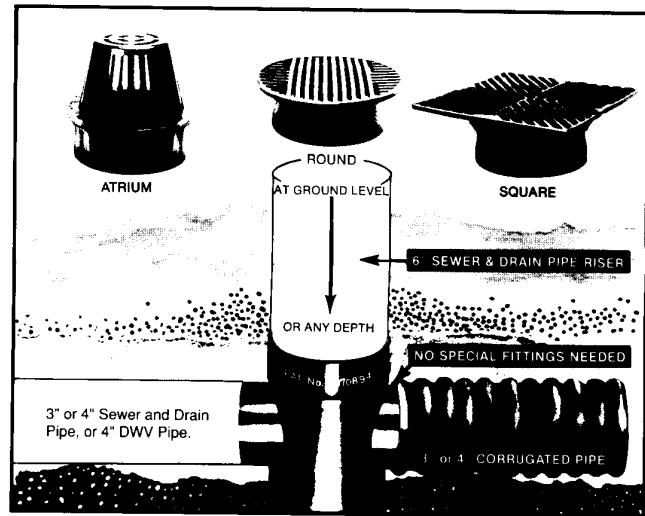

SQUARE GRATES

| | | |
|---------------------|--|-----------|
| 9" SQUARE | 9" Fits 6" SPEE-D Basin | 950-Green |
| | 6" Sewer and Drain Pipe | 960-Grey |
| | 6" Sewer and Drain Fittings | 970-Black |
| | 6" Corrugated Pipe | |
| 8" SQUARE | 8" Fits 6" SPEE-D Basin | 881-Black |
| | 6" Sewer and Drain Pipe | 882-Green |
| | 6" Sewer and Drain Fittings | 883-Grey |
| | 6" Corrugated Pipe | |
| 7" SQUARE | 7" Fits 6" SPEE-D Basin | 771-Black |
| | 6" Sewer and Drain Pipe | 772-Green |
| | 6" Sewer and Drain Fittings | 773-Grey |
| | 6" Corrugated Pipe | |
| 6" SQUARE | 6" Fits 3" or 4" Sewer and Drain Pipe, 2" SCH. 40 Couplings and 3" or 4" Corrugated Pipe | 04-Black |
| | | 05-Green |
| | | 06-Grey |
| | | |
| 5" SQUARE | 5" Fits 4" Sewer and Drain Fittings, 4" Corugated Pipe and 4" Sewer and Drain Pipe | 07-Green |
| | | 08-Black |
| | | 09-Grey |
| | | |
| 4" SQUARE | 4" Fits 3" Sewer and Drain Fittings, 3" Corrugated, Pipe and 3" Sewer and Drain Pipe | 01-Green |
| | | 02-Black |
| | | 03-Grey |



BRASS GRATES

BRASS GRATES

| | |
|------------------------------|------|
| 3" Satin Brass Grate, Round | 909B |
| 4" Satin Brass Grate, Round | 910B |
| 5" Satin Brass Grate, Square | 913B |

POLISHED BRASS GRATES

| | |
|--------------------------------|-------|
| 3" Polished Brass Grate, Round | 905PB |
| 4" Polished Brass Grate, Round | 906PB |
| 5" Polished Brass Grate Square | 914PB |



6" SQUARE BRASS GRATE

6" Satin Brass Grate, Square 920

MINI CHANNEL BRASS GRATE

| | |
|-------------------------|-------|
| 1' Satin Brass Grate | 552B |
| 1' Polished Brass Grate | 553PB |



ATRIUM GRATES

| | | |
|---------------------|--|----------------|
| 6" ATRIUM | 6" Grate Fits SPEE-D Catch Basin | 80-Green |
| | 6" Sewer and Drain Fittings | 90-Black |
| | 6" Corrugated and Sewer and Drain Pipe | |
| 4" ATRIUM | 4" Grate Fits 4" Sewer and Drain Fittings, Couplings, Corrugated Pipe and Sewer and Drain Pipe | 75-Green |
| | | 78-Black |
| | | |
| 3" ATRIUM | 3" Grate Fits 3" Sewer and Drain Fittings, Corrugated Pipe and Sewer and Drain Pipe | 70-Green |
| | | 74-Black |
| | | |
| 2" ATRIUM | 2" Fits Schedule | 270-White Only |

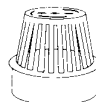

NDS SURFACE DRAIN PRODUCTS (CONT'D)

BASINS, ADAPTERS, GRATES, VALVE BOXES

9" X 9" and 12" X 12" GRATES

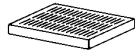

9" and 12" GRATE

- | | | |
|------|------------------|-------|
| 980 | 9" Square Grate | Black |
| 990 | 9" Square Grate | Green |
| 999 | 9" Square Grate | Grey |
| 1210 | 12" Square Grate | Grey |
| 1211 | 12" Square Grate | Black |
| 1212 | 12" Square Grate | Green |

12" X 12" ATRIUM GRATES



12" X 12" ATRIUM

- | | | |
|------|------------------|-------|
| 1280 | 12" Atrium Grate | Green |
| 1290 | 12" Atrium Grate | Black |

9" X 9" and 12" X 12" CATCH BASINS

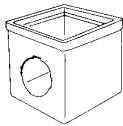

9" and 12" BASIN

- | | | |
|-------|---------------------------|-------|
| 900 | 9" Basin Two Opening * | Black |
| 900-4 | 9" Basin Four Opening * | Black |
| 1200 | 12" Basin Two Opening * | Black |
| 1203 | 12" Basin Three Opening * | Black |
| 1204 | 12" Basin Four Opening * | Black |
- (* Requires Either 1206, 1243 or 1266 for each Opening.)

9" X 9" and 12" X 12" ADAPTERS

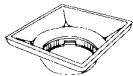

9" and 12" ADAPTERS

- | | | |
|------|--|-------|
| 930 | 9" X 9" Square Fits Corrugated and Sewer and Drain Pipe. (Requires Either 1243 or 1266.) | Black |
| 1230 | 12" Square Fits Corrugated Pipe and Sewer and Drain Pipe. (Requires 1243 or 1266) | Black |

18" X 18" GRATES



18" X 18" GRATE

- | | | |
|------|------------------|-------|
| 1810 | 18" Square Grate | Black |
| 1811 | 18" Square Grate | Black |
| 1812 | 18" Square Grate | Black |

18" X 18" CATCH BASINS

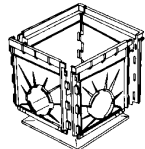

18" X 18" BASIN

- | | | |
|------|-------------------------|-------|
| 1800 | 18" Basin Two Opening* | Black |
| 1804 | 18" Basin Four Opening* | Black |
- * Includes Four Sides with Reducer Rings and One Bottom. (Requires Outlets.)

18" X 18" ADAPTERS

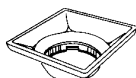

18" ADAPTERS

- | | | |
|------|---|-------|
| 1830 | 18" X 18" Square Fits 3", 4", 6" or 8" Corrugated or Sewer and Drain Pipe Includes 1890 Reducer Ring (Requires 1243, 1244, 1266, or 1888.) | Black |
|------|---|-------|

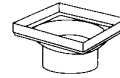

12" X 12" X 8" SQUARE ADAPTER

- | | | |
|------|---|-------|
| 1221 | 12" Square X 8" Sewer and Drain Hub Adapter | Black |
|------|---|-------|

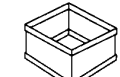

9" and 12" RISER EXTENSION

- | | | |
|------|--|-------|
| 1222 | 12" Square X 8" Corrugated Pipe SPG. Adapter | Black |
|------|--|-------|

9" and 12" RISER EXTENSIONS

- | | | |
|------|--|-------|
| 916 | 6" Extension Fits 9" Catch Basin and Adapter | Black |
| 1216 | 6" Extension Fits 12" Catch Basin and Adapter | Black |

UNIVERSAL OUTLETS

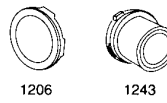

1206 1243

- | | | |
|------|--|-------|
| 1206 | Plug | Black |
| 1243 | Combination 4" X 3" Outlet Fits 4" and 3" Corrugated Pipe and 4" Sewer and Drain Pipe | Black |

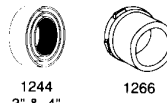

1244 1266

- | | | |
|------|---|-------|
| 1244 | Combination Outlet Fits 3" and 4" Sewer and Drain Pipe and 3" and 4" Corrugated Pipe | Black |
| 1266 | 6" Outlet Fits 6" Sewer and Drain Pipe and 6" Corrugated Pipe | Black |
- (Use Universal Outlets with 9" X 9", 12" X 12" and 18" X 18" Catch Basins and Adapters)

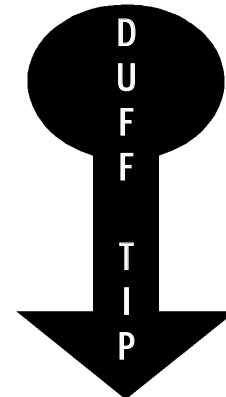

DUFF CAN DESIGN
AND/OR SUPPLY
ANY TYPE
OF
IRRIGATION SYSTEM
OR EQUIPMENT!

NDS SURFACE DRAIN PRODUCTS (CONT'D)

CHANNEL DRAINAGE PRODUCTS AND FITTINGS

SPEE-D CHANNEL DRAIN

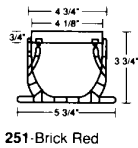

251-Brick Red

400
4' Channel Drain
Grey

400-10
10' Channel Drain
Grey

229
Screws Stainless Steel,
Type "A" F.H. #8 X 1"

CHANNEL SPECIFICATIONS
Material - High Impact P.V.C.
with 2% UV Inhibitors

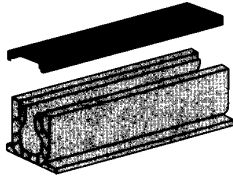

2' Channel Grate

240-White
241-Grey
242-Green
243-Black
244-Sand

GRATE SPECIFICATIONS
Material - High Density
Polyethylene



Channel
Coupling
248-Grey



Strainer Coupling
245-Grey



Channel
End Cap
247-Grey



3" S & D
Spigot Adapter
249-Grey



2" Schedule 40
Spigot Adapter
246-Grey



9" Long Fabricated
Cross and Grate
2360-White
2361-Grey
2362-Green
2363-Black
2364-Sand
2365-Brick Red



7" Long Fabricated Tee
and Grate
2370-White
2371-Grey
2372-Green
2373-Black
2374-Sand
2375-Brick Red



7" Long Fabricated 90°
??? and Grate
2380-White
2381-Grey
2382-Green
2383-Black
2384-Sand
2385-Brick Red



7" Long Fabricated 45°
and Grate
2300-White
2301-Grey
2302-Green
2303-Black
2304-Sand
2305-Brick Red



2" Long Fabricated
3" & 4" Spigot Bottom
Outlet with Strainer
234-Grey
Fits 3" or 4" Sewer and
Drain Fittings. (Grate Not
Included.)

MINI SPEE-D CHANNEL DRAIN

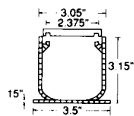

500
6' Foot Mini
Snap-On Channel
Grey

529
Screws Stainless Steel
Type FA - 1/4" x 3/4"

CHANNEL SPECIFICATIONS
Material - High Impact P.V.C.
with 2% UV Inhibitors

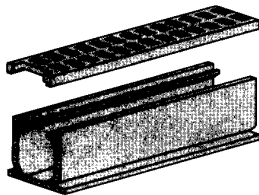

3' Channel Grate

540-White
541-Grey
542-Green
543-Black
544-Sand
551-Brick Red

GRATE SPECIFICATIONS
Material - High Density
Polyethylene or Solid Brass

1' Brass Channel Grate

552B-Satin Brass
553PB-Polished Brass



Channel
Coupling
548-Grey



Channel
End Cap
547-Grey



2" Schedule 40
Spigot Adapter
546-Grey



2" Schedule 40
Hub to 3" S&D
Spigot Adapter
542-White



2" Schedule 40
Hub to 4" S&D
Spigot Adapter
533-White

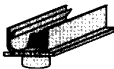

2" Schedule 40
Spigot Adapter Bottom
Outlet 3" Long
550-White
Grate Not Included



4" Long Fabricated Tee
and Grate
5370-Grey
5371-Green
5372-Black
5373-Sand
5374-Brick Red



4" Long Fabricated 90°
and Grate
5380-Grey
5381-Green
5382-Black
5383-Sand
5384-Brick Red



4" Long Fabricated 45°
and Grate
5300-Grey
5301-Green
5302-Black
5303-Sand
5304-Brick Red

MICRO CHANNEL

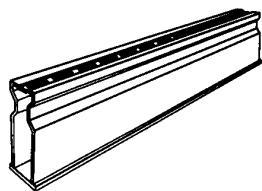
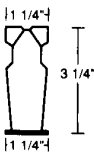

10' Long Micro Channel
Includes Couplings

8001-White
8002-Sand
8003-Grey

SPECIFICATIONS
Channel length - 10 feet
Material - High Impact P.V.C.
with 2% UV Inhibitors



Micro Hold Down Clips
8601-White Only



Micro End Plug
8471-White



Micro 1 1/2" Spigot
Schedule 40 End Outlet
8461-White



Micro Coupling
Fits Into Micro
Channel
8481-White



Micro Tee
8371-White
8372-Sand
8373-Grey



Micro 1 1/2" Spigot
Schedule 40
Bottom Outlet
8501-White
8502-Sand
8503-Grey



Micro 1 1/2" Spigot
Schedule 40 Side
Outlet
8511-White
8512-Sand
8513-Grey



Micro Clean Out
8651-White
8652-Sand
8653-Grey



Micro 45°
8301-White
8302-Sand
8303-Grey



Micro 90°
8381-White
8382-Sand
8383-Grey

CALL DUFF NOW FOR PRICING AND AVAILABILITY!

610-275-4453

OR FAX US AT

610-279-6299

PLASTIC VALVES

SIZE FIG. NO. PRICE
COMPRESSION PVC SWING CHECK VALVE

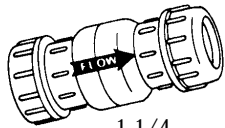

| | |
|---------------|-------|
| 1 1/4 | 15891 |
| 1 1/2 | 15893 |
| 2 | 15895 |
| 3 | 15897 |
| 1 1/4 X 1 1/2 | 15900 |

SIZE FIG. NO. PRICE
SOLVENT WELD HUB X HUB SWING CHECK VALVE

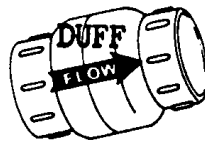

| | |
|-------|-------|
| 1 1/2 | 15918 |
| 2 | 15920 |
| 3 | 15923 |
| 4 | 15925 |

SIZE FIG. NO. PRICE
POPPET CHECK VALVE SOLVENT WELD

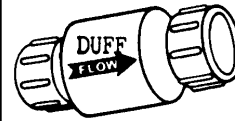

| | |
|-------|-------|
| 1/2 | 15876 |
| 3/4 | 15879 |
| 1 | 15882 |
| 1 1/4 | 15884 |
| 1 1/2 | 15886 |
| 2 | 15888 |

POPPET PVC CHECK VALVES FIPT X FIPT

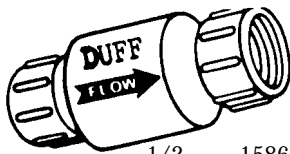

| | |
|-------|-------|
| 1/2 | 15868 |
| 3/4 | 15869 |
| 1 | 15870 |
| 1 1/4 | 15871 |
| 1 1/2 | 15872 |
| 2 | 15874 |

FOOT VALVE SCREEN

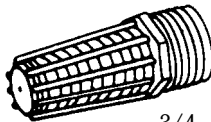

| | |
|-------|-------|
| 3/4 | 42715 |
| 1 | 42716 |
| 1 1/4 | 42717 |
| 1 1/2 | 42718 |

PVC COMPRESSION COUPLING

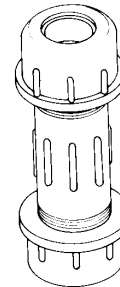

Will fit any Schedule 40 or Schedule 80 Pipe.

| | |
|-------|-------|
| 1/2 | 15927 |
| 3/4 | 15929 |
| 1 | 15931 |
| 1 1/4 | 15932 |
| 1 1/2 | 15933 |
| 2 | 15934 |
| 2 1/2 | 15935 |
| 3 | 15936 |
| 4 | 15937 |
| 6 | 15938 |

PLASTIC HANGER

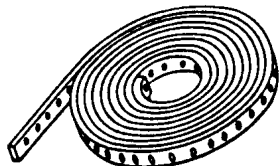

100' 15991

POLYETHYLENE DRUM & BARREL FAUCETS

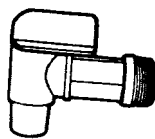

Strong polyethylene construction with excellent chemical resistance properties. Use with water and approved chemicals.

| | |
|-----|-------|
| 3/4 | 18962 |
|-----|-------|

QUICK FIX REPAIR COUPLING TO REPAIR BREAK, ADD A LINE, ADD A VALVE

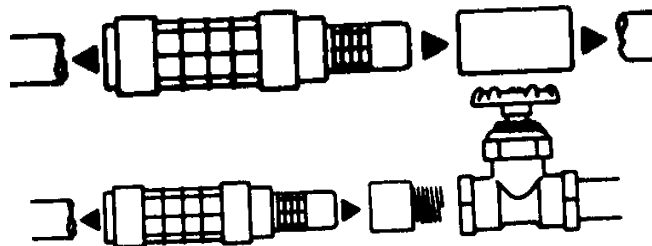

Schedule 40, 150# PSI, long extension, union connection, Slip X Spigot

| SIZE | FIG. NO. | PRICE |
|-------|----------|-------|
| 1/2 | 63684 | |
| 3/4 | 63685 | |
| 1 | 63690 | |
| 1 1/4 | 63686 | |
| 1 1/2 | 63687 | |

| SIZE | FIG. NO. | PRICE |
|-------|----------|-------|
| 2 | 63688 | |
| 2 1/2 | 63799 | |
| 3 | 63800 | |
| 4 | 63801 | |

PLASTIC SADDLE ASSEMBLY



PIPE SIZE FEM THREAD FIG. NO. PRICE
OUTLET

| | | | |
|-------|-----|-----------|--|
| 3/4 | 1/2 | PST34X12 | |
| 3/4 | 3/4 | PST34X34 | |
| 1 | 1/2 | PST1X12 | |
| 1 | 3/4 | PST1X34 | |
| 1 1/4 | 1/2 | PST114X12 | |
| 1 1/4 | 3/4 | PST114X34 | |
| 1 1/2 | 1/2 | PST112X12 | |
| 1 1/2 | 3/4 | PST112X34 | |
| 2 | 1/2 | PST2X12 | |
| 2 | 3/4 | PST2X34 | |

PLASTIC VALVES CONT'D

TRUE UNION BALL VALVES



Hayward
Asahi
Chemtrol
Socket and threaded
Flanged valves also in stock

| PVC | | |
|-------|----------|-------|
| SIZE | FIG. NO. | PRICE |
| 1/4 | 11763 | |
| 3/8 | 11786 | |
| 1/2 | 46981 | |
| 3/4 | 11754 | |
| 1 | 11756 | |
| 1 1/4 | 11758 | |
| 1 1/2 | 11760 | |
| 2 | 11762 | |
| 2 1/2 | 17721 | |
| 3 | 17722 | |
| 4 | 17723 | |

| CPVC | | |
|-------|----------|-------|
| SIZE | FIG. NO. | PRICE |
| 1/2 | 36765 | |
| 3/4 | 36766 | |
| 1 | 36767 | |
| 1 1/4 | 36768 | |
| 1 1/2 | 36769 | |
| 2 | 36770 | |

PVC BUTTERFLY VALVES



150 PSI rated valve
Meets face to face industry standards
Will replace most metal valve
Lock out handle to lock valve in one of seven positions
Sizes available up to 24"

| SIZE | FIG. NO. | PRICE |
|------|----------|-------|
| 2 | 30010 | |
| 3 | 30011 | |
| 4 | 30013 | |
| 6 | 30015 | |
| 8 | 30016 | |

PVC BALL CHECK VALVES



Seats with minimum back pressure
Free floating ball never seats in same position twice
Horizontal or vertical installation

Sizes up to 6" available
Easily converted to foot valve
Full port

| SIZE | FIG. NO. | PRICE |
|-------|----------|-------|
| 1/2 | 12005 | |
| 3/4 | 12007 | |
| 1 | 12014 | |
| 1 1/4 | 12017 | |
| 1 1/2 | 12020 | |
| 2 | 12021 | |
| 3 | 12024 | |
| 4 | 12025 | |

HAYWARD TXT NEEDLE VALVE



| SIZE | FIG. NO. | PRICE |
|------|----------|-------|
| 1/2 | 59378 | |

3-WAY BALL VALVES

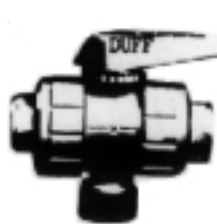

| SIZE | FIG. NO. | PRICE |
|------|----------|-------|
| 3/4 | 51769 | |
| 1 | 51742 | |

HAYWARD PVC PRESSURE RELIEF VALVE

Sizes 1/2" to 2" available for quick shipment



GLOBE



Sizes 1/2" thru 4" available for quick

PVC COMPACT BALL VALVES



| T H D X T H D | | |
|---------------|----------|-------|
| SIZE | FIG. NO. | PRICE |
| 1/2 | 11873 | |
| 3/4 | 11877 | |
| 1 | 11879 | |
| 1 1/4 | 11882 | |
| 1 1/2 | 11886 | |
| 2 | 11889 | |

| SLIP X SLIP | | |
|-------------|----------|-------|
| SIZE | FIG. NO. | PRICE |
| 1/2 | 11856 | |
| 3/4 | 11859 | |
| 1 | 11860 | |
| 1 1/4 | 11862 | |
| 1 1/2 | 11864 | |
| 2 | 11866 | |
| 2 1/2 | 44481 | |
| 3 | 11869 | |
| 4 | 25121 | |

GATE VALVES

Sizes 1 1/2" thru 8" available for quick shipment
PVC or PVDF



HORIZONTAL SWING CHECK VALVES



Sizes 3/4" thru 8" available for quick shipment

VINYL FLOAT VALVE



| 3/4" | |
|----------|-------|
| FIG. NO. | PRICE |
| 65294 | |



GEORGE FISCHER +GF+



Chemtrol
A DIVISION OF NIBCO INC.

Hayward

All readily available!

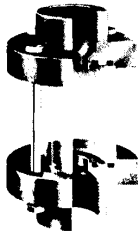

**SERIES "GX" & "GY"
SIGHT GLASS
FLOW INDICATORS**

For safe, positive indication of flow and clarity of corrosive or ultra-pure liquids. Available with vinyl streamers to help detect flow. Series "GX" has only an acrylic cylinder wall for economy. Series "GY" has an acrylic outer cylinder protecting a Pyrex inner cylinder. Sizes 1/2" to 3" NPT.

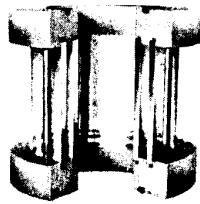

**SERIES "GYW"
WAFER SIGHT GLASSES**

Offers safe and positive indication of flow or clarity of corrosive or ultra-pure liquids in larger piping systems. Double wall construction. Fits between standard companion flanges. Sizes 1-1/2" to 8" pipe.

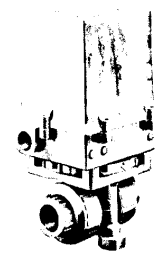

**TRUE-BLUE™
SERIES "EBV" 2-WAY & "TEBV" 3-WAY
ELECTRICALLY ACTUATED BALL VALVES**

Thermally protected, heavy-duty motor with 7 second cycle time. Designed to meet NEMA IV standards. Rugged all plastic construction - ideal for corrosive atmospheres. For use with computer-controlled automated systems. Compact design with manual over-ride. Position and motor running lights. Simple attachment to the valve body mounting lugs. Two actuator sizes for the valve range of 1/2" through 2".

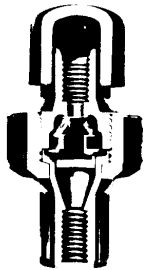

**SERIES "VBM" & "VB"
VACUUM BREAKERS**

Protective vacuum breakers eliminate unwanted siphonage or collapsing of storage tanks. Sensitive molded diaphragm offers normally closed operation and will respond to a minimum of vacuum; however, they are not recommended for protection of thin-wall tanks. Sizes 1/2", 3/4" and 1" NPT.

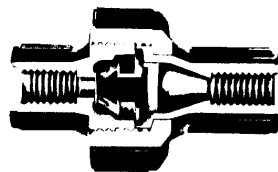

**SERIES "CKM" & "CK"
DIAPHRAGM CHECK VALVES**

Leak-proof check valves prevent reverse flow of extremely corrosive and ultra-pure liquids. Self-sealing design allows mounting in any position. Unique molded diaphragm offers you normally closed operation, operates silently, and seals in the same location every time. Size 1/2", 3/4" and 1". Also our CKD series with very sensitive opening is available 1/4" and 1/2".

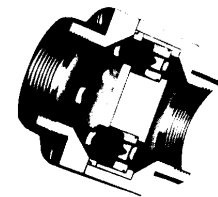

**SERIES "FC"
FLOW CONTROL VALVES**

Automatic valves to maintain a constant flow regardless of inlet pressure changes between 15 and 100 PSI. No metal in contact with liquid. Flow rates from 1/4 to 120 GPM. Sizes 1/4" to 3".

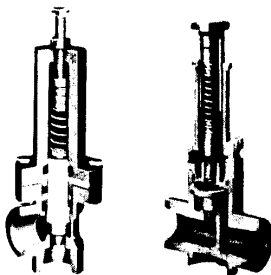

**SERIES "RVT" & "RVDM"
ANGLE PATTERN & IN-LINE RELIEF VALVES**

Prevent overpressures, maintain back pressures or automatic by-pass in vessels and piping. Series RVT angle pattern has non sticking Teflon® shaft. Series RVDM in-line pattern has a frictionless rolling diaphragm design for sensitive operation. Settings from 5 to 100 PSI. FAIL-DRY®, 1/2"-2". Series RVD angle pattern diaphragm design (not shown) 1/8"-1/2" NPT, 5 to 150 PSI.

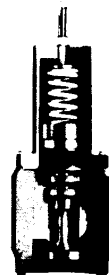

**SERIES "PR" AND "PRH"
PRESSURE REGULATING VALVES**

Accurately reduce and regulate steady or varying inlet pressures and maintain a constant predetermined outlet set pressure. Regulator settings from 5 to 75 PSI. Sizes 1/4" to 3". Higher set pressures available.

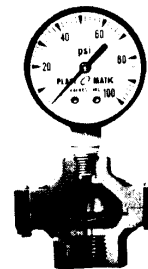

**SERIES "GGM"
CHEMICAL GAUGE GUARDS**

Protects instruments from corrosion and clogging while maintaining high accuracy. Unique optional "Snubber" insert reduces pressure pulsations, provides even, more precise readings and reduces needle-fluctuation damage. Available with or without pressure or vacuum gauges. Inlet 1/2". Gauge connection 1/4" or 1/2".

All readily available!

NEW!



**SERIES "GGME"
MINIATURE DIAPHRAGM SEAL
GAUGE GUARD**

Compact size - ideal for small applications. Low cost - now feasible to protect lower priced pressure and vacuum instruments from clogging and corrosion. Molded glass filled polypropylene body - for excellent chemical compatibility and avoiding possibility of leaks. ±4% accuracy handles most applications. 1/4" FPT x 1/2" MPT.

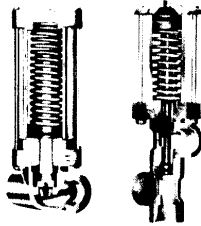

**SERIES "EST"
SHUTOFF VALVES AND
SERIES "F" DIVERTER VALVES
AUTOMATIC, AIR OPERATED**

Shutoff valves (2-Way) normally closed or normally open, air by air, line pressure by air operation. Diverter valves (3-Way) direct flow. One (or two) common inlet(s) to two (or one) common outlet(s). FAIL-DRY[®] design and clear acrylic air cylinder shows valve position, standard on all. Sizes 1/2" through 2".



**SERIES "KST", "VSTS" & "LST"
LINE BASKET STRAINERS**

Protects equipment by removing solids and foreign materials from liquid lines. Safer and easier to use than Y-strainers. Sturdy construction large capacity, high performance corrosion resistant. Sizes 2" to 14". PVC CPVC (CORZAN[™]) & Polypro.



**SERIES "BSD"
MINIATURE AIR OPERATED
DIAPHRAGM VALVE**

Long cycle life and compact design. Excellent for ultra-high purity or highly corrosive liquids. Body is PVDF (other materials also available) with a Teflon diaphragm. Million-cycle design. Connections can be female socket, female threads, or nipples. Smooth internal cavities to avoid dead corners. Sizes 1/4" - 1", 1/8" NPT air connection. Standard is normally closed spring return.

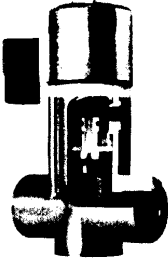

**SERIES "EASMT" & "EASYMT"
DIRECT OPERATING - NORMALLY CLOSED
TEFLON[®] BELLOWS SOLENOID VALVE**

For severe service applications with virtually all solutions (acids, caustics, etc.). Unique "Bellows" design provides dynamic barrier seal, prevents leaking of emissions. 2,000,000 cycle life. Fail-Dry safety design. Sizes 1/8" to 1". C_v from 1.1 to 4.7, orifice from 3/8" to 11/16".



**SERIES "EASMD" & "EASYMD"
DIRECT OPERATING
DIAPHRAGM SOLENOID VALVES**

Has rolling diaphragm and FAIL-DRY[®] concept for normally closed on-off services of caustics and salt solutions to eliminate crystallization problems. Does not require pressure to operate. Orifice diameters from 7/16 to 11/16. Available in pipe sizes 1/4", 1/2", 3/4" & 1".

LIQUID LEVEL GAUGE PVC

All parts coming in contact with liquid made are made of PVC. PVC has greater resistance to corrosive environments and solutions than many other materials. This gage can be used in place of stainless steel and monel. To determine length of glass and rods: Glass 2" shorter than centers. Rods 1 1/4" shorter than centers. Can be furnished with or without ball check. Furnished without check unless specified. Glass and Guard Rods: Valves are equipped to accommodate four 3/16" diameter guard rods. Unless otherwise specified, gages will be furnished with glass and rods for 18" centers.

3/4" AND 1/2" AVAILABLE!

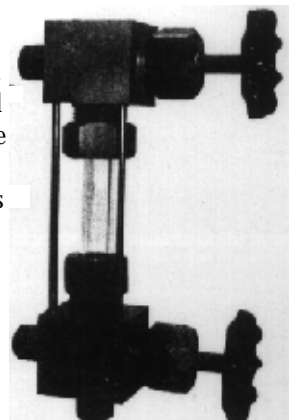

DUFF
610-275-4453

CPVC TUBE SIZE
TUBE & FITTINGS

| | SIZE | FIG. NO. | PRICE |
|--|------|----------|-------|
|--|------|----------|-------|

CTS TEE (SXS)



| | |
|-----|-------|
| 1/2 | 11900 |
| 3/4 | 11912 |

CTS 90° ELL (SXS)



| | |
|-----|-------|
| 1/2 | 11772 |
| 3/4 | 11790 |

CTS STREET ELL (SXST)



| | |
|-----|-------|
| 1/2 | 12002 |
| 3/4 | 12013 |

CTS DROP EAR ELL (FPTXS)



| | |
|-----|-------|
| 1/2 | 11798 |
|-----|-------|

CTSC 45° ELL (SXS)



| | |
|-----|-------|
| 1/2 | 11809 |
| 3/4 | 11826 |

CTS ADAPTER (PVCXCPVC)



| | |
|-----|-------|
| 3/4 | 49378 |
|-----|-------|

CTS COUPLING (SXS)



| | |
|---------|-------|
| 1/2 | 11734 |
| 3/4 | 11743 |
| 3/4X1/2 | 19424 |

CTS MALE ADAPTER (MPTXS)



| | |
|-----|-------|
| 1/2 | 11848 |
| 3/4 | 11858 |

CTS FEMALE ADAPTER W/ SEAL (SXFPT)



| | |
|-----|-------|
| 1/2 | 11871 |
| 3/4 | 11888 |

CTS REDUCER BUSHING (SPGXS)



| | |
|---------|-------|
| 3/4X1/2 | 11945 |
|---------|-------|

CTS CAP (S)



| | |
|-----|-------|
| 1/2 | 11724 |
| 3/4 | 11728 |

| | SIZE | FIG. NO. | PRICE |
|--|------|----------|-------|
|--|------|----------|-------|

CTS TRANSITION TAILPIECE (SPG)



| | |
|-----|-------|
| 1/2 | 11752 |
| 3/4 | 11764 |

HANGER



| | |
|-----|-------|
| 1/2 | 11954 |
| 3/4 | 11965 |

RISER ADAPTER (SPTXS)



| | |
|----------------------|-------|
| 1/2 slip x 3/8 OD | 63320 |
|----------------------|-------|

CPVC VALVES

LINE STOP CPVC X CPVC



| | |
|-----|-------|
| 1/2 | 42452 |
| 3/4 | 42453 |

BOILER DRAIN CPVC X MALE HOSE



| | |
|-----|-------|
| 1/2 | 11964 |
| 3/4 | 11967 |

BALL VALVE CPVCXCPVC

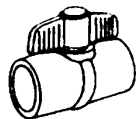

| | |
|-----|-------|
| 1/2 | 38680 |
| 3/4 | 38681 |

SUPPLY STOP-ANGLE CPVCXOD

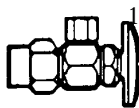

| | |
|---------|-------|
| 1/2X3/8 | PR19C |
|---------|-------|

SUPPLY STOP-STRAIGHT CPVCXOD



| | |
|---------|-------|
| 1/2X3/8 | PR14C |
|---------|-------|

CPVC CTS COMPRESSION COUPLING

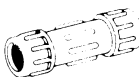

| | |
|-----|-------|
| 1/2 | 11976 |
| 3/4 | 11989 |

| | SIZE | FIG. NO. | PRICE |
|--|------|----------|-------|
|--|------|----------|-------|

CPVC TUBING

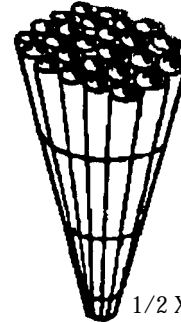

| | |
|-----------|-------|
| 1/2 X 10' | 11718 |
| 3/4 X 10' | 11721 |

FOR A
COMPLETE LISTING
OF SOLVENTS,
PLEASE SEE
PAGE 608

PLASTIC SUPPLY LAV TUBE



| | |
|--------|-------|
| 3/8X12 | 10943 |
| 3/8X20 | 10946 |

PLASTIC SUPPLY CLOSET TUBE



| | |
|--------|-------|
| 3/8X12 | 10958 |
|--------|-------|



PVC CEMENT

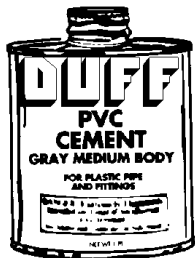

PVC CEMENT
CLEAR MEDIUM BODY FOR UP TO
2" PIPE

| SIZE | FIG. NO. | PRICE |
|--------|----------|-------|
| 1/4 PT | 15154 | |
| 1/2 PT | 15155 | |
| PINT | 15156 | |
| QUART | 15157 | |
| GAL | 15158 | |



ALL PURPOSE
CEMENT

| SIZE | FIG. NO. | PRICE |
|--------|----------|-------|
| 1/4 PT | 15169 | |
| 1/2 PT | 15170 | |
| PINT | 15171 | |
| QUART | 15172 | |

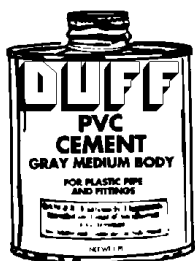

HEAVY DUTY
GRAY
MEDIUM BODY
PVC CEMENT
FOR LARGER SIZE PIPE

| SIZE | FIG. NO. | PRICE |
|--------|----------|-------|
| 1/2 PT | 15160 | |
| PINT | 15161 | |
| QUART | 15162 | |

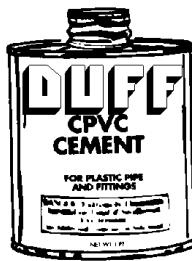

CPVC CEMENT FOR TUBING

| SIZE | FIG. NO. | PRICE |
|--------|----------|-------|
| 1/4 PT | 15164 | |
| 1/2 PT | 15165 | |
| PINT | 15166 | |
| QUART | 15167 | |

CPVC CEMENT FOR PIPE

| SIZE | FIG. NO. | PRICE |
|-------|----------|-------|
| PINT | 48745 | |
| QUART | 48747 | |

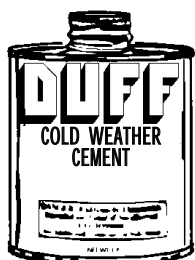

COLD WEATHER
PVC CEMENT

| SIZE | FIG. NO. | PRICE |
|-------|----------|-------|
| PINT | 15190 | |
| QUART | 15191 | |



PVC POOL CEMENT BLUE
FOR WET LOCATIONS

| SIZE | FIG. NO. | PRICE |
|-------|----------|-------|
| PINT | 51520 | |
| QUART | 50530 | |



CLEAR PRIMER

| SIZE | FIG. NO. | PRICE |
|--------|----------|-------|
| 1/4 PT | 15185 | |
| 1/2 PT | 15186 | |
| PINT | 15187 | |
| QUART | 15188 | |
| GAL | 15189 | |



PURPLE PRIMER

| SIZE | FIG. NO. | PRICE |
|--------|----------|-------|
| 1/4 PT | 15179 | |
| 1/2 PT | 15180 | |
| PINT | 15181 | |
| QUART | 15183 | |

PVC PIPE

ENGINEERING DATA



Pressure/Temperature Relationship

MAXIMUM OPERATING PRESSURE — PSI (WATER @ 73°F)

| Nominal Pipe Size (IPS) | Schedule 40 PVC and CPVC | Schedule 80 PVC | | | Schedule 80 CPVC | SDR Pressure Rated Pipe ⁴ PVC Plain and Belled End | | |
|-------------------------|-----------------------------|-----------------|-----------------------|--------------|------------------------|---|--------|----------|
| | Plain & Belled ¹ | Plain End | Threaded ² | Roll Grooved | Plain End ³ | SDR 26 | SDR 21 | SDR 13.5 |
| 1/4" | NA | 1130 | NA | NA | NA | NA | NA | NA |
| 1/2" | 600 | 850 | 420 | NA | 850 | NA | NA | 315 |
| 3/4" | 480 | 690 | 340 | NA | 690 | NA | 200 | — |
| 1" | 450 | 630 | 320 | NA | 630 | NA | 200 | — |
| 1 1/4" | 370 | 520 | 260 | NA | 520 | 160 | 200 | — |
| 1 1/2" | 330 | 470 | 240 | NA | 470 | 160 | 200 | — |
| 2" | 280 | 400 | 200 | 400 | 400 | 160 | 200 | — |
| 2 1/2" | 300 | 420 | 210 | 420 | 420 | 160 | 200 | — |
| 3" | 260 | 370 | 190 | 370 | 370 | 160 | 200 | — |
| 4" | 220 | 320 | 160 | 320 | 320 | 160 | 200 | — |
| 5" | 190 | 290 | NR | 290 | 290 | 160 | 200 | — |
| 6" | 180 | 280 | NR | 280 | 280 | 160 | 200 | — |
| 8" | 160 | 250 | NR | 250 | 250 | 160 | 200 | — |
| 10" | 140 | 230 | NR | 230 | 230 | 160 | 200 | — |
| 12" | 130 | 230 | NR | 230 | 230 | 160 | 200 | — |
| 14" | 130 | 220 | NR | 220 | NA | 160 | 200 | — |
| 16" | 130 | 220 | NR | 220 | NA | 160 | 200 | — |

(NR-Not Recommended)
(NA-Not Available)

1. Threading Schedule 40 and SDR/PR pipe is not recommended.
2. Threading Schedule 80 pipe above 4" is not recommended.

3. CPVC threaded connections should be avoided when possible at elevated temperatures and pressures. (Consult factory.)
4. Standard dimensional ratio pipe (SDR) will carry the same pressure rating for all diameters according to the SDR number.

The operating pressures listed above are based on the hydrostatic design of the product using water as a test medium at 73°F. Compounding nomenclature for Esilon PVC is PVC 1120 with a cell class of 12454-B. For Esilon CPVC pipe it is CPVC 4120 with a cell class of 23447-A.

The following temperature corrections must be used to derate all PVC and CPVC pipe, valves and fittings when operating temperatures are expected to exceed 73°F.

For schedule-rated products and SDR/PR pipe, the following equation was used to determine operating pressures for outside diameter controlled pipe:

$$P = \frac{2ST}{D - T}$$

- Where: P = pressure (PSI)
D = average outside diameter
T = minimum wall thickness
S = hydrostatic design stress (HDS) for Esilon PVC Type I, Grade 1, HDS = 2,000 PSI
Esilon CPVC also = 2,000 PSI

The working pressure of PVC and CPVC pipe is directly affected by temperature changes. When the operating temperature of the pipe increases, the pipe loses its stiffness and tensile strength decreases. A drop in pressure capacity results. The drop can be calculated using this chart. Multiply the pipe's maximum working pressure by the temperature correction factor for a known temperature.

Example: For 2" Schedule 80 PVC pipe, the maximum working pressure is 400 psi. If the operating temperature is known to be 110°F, the correction factor can be found on the chart to be 0.50. The adjusted pressure would then be 400 × 0.50 = 200 psi.

TEMPERATURE CORRECTION FACTORS

| Operating Temperature (°F) | 70 | 80 | 90 | 100 | 110 | 115 | 120 | 125 | 130 | 140 | 150 | 160 | 170 | 180 | 200 |
|----------------------------|------|------|-----|-----|-----|-----|-----|-----|-----|-----|-----------------|-----|-----|-----|-----|
| PVC 1120 | 1.00 | .88 | .75 | .62 | .50 | .45 | .40 | .35 | .30 | .22 | Not Recommended | | | | |
| CPVC 4120 | 1.00 | 1.00 | .91 | .82 | .77 | .74 | .65 | .66 | .62 | .50 | .47 | .40 | .32 | .25 | .20 |

CAUTION: Esilon Thermoplastics does not recommend its products for use in air or compressed gas systems.

PVC Type I Pressure Rated Pipe

FOR WATER MAINS, IRRIGATION, ETC.

SDR 26 NSF — W.P. 160 PSI (Water @ 73.4° F.)

SDR 21 NSF — W.P. 200 PSI (Water @ 73.4° F.)

| Nominal Pipe Size (in.) | O.D. | Min. Wall | Average I.D. | Nominal Weight per ft. |
|-------------------------|--------------|-----------|--------------|------------------------|
| 1/2 | See SDR 13.5 | | | |
| 3/4 | See SDR 21 | | | |
| 1 | 1.315 | .060 | 1.175 | .164 |
| 1-1/4 | 1.660 | .064 | 1.512 | .221 |
| 1-1/2 | 1.900 | .073 | 1.734 | .284 |
| 2 | 2.375 | .091 | 2.173 | .432 |
| 2-1/2 | 2.875 | .110 | 2.635 | .622 |
| 3 | 3.500 | .135 | 3.210 | .915 |
| 3-1/2 | 4.000 | .154 | 3.672 | 1.183 |
| 4 | 4.500 | .173 | 4.134 | 1.494 |
| 5 | 5.563 | .214 | 5.109 | 2.288 |
| 6 | 6.625 | .255 | 6.085 | 3.228 |
| 8 | 8.625 | .332 | 7.921 | 5.468 |
| 10 | 10.750 | .413 | 9.874 | 8.492 |
| 12 | 12.750 | .490 | 11.710 | 11.956 |

| Nominal Pipe Size (in.) | O.D. | Min. Wall | Average I.D. | Nominal Weight per ft. |
|-------------------------|--------------|-----------|--------------|------------------------|
| 1/2 | See SDR 13.5 | | | |
| 3/4 | 1.050 | .060 | .910 | .129 |
| 1 | 1.315 | .063 | 1.169 | .170 |
| 1-1/4 | 1.660 | .079 | 1.482 | .263 |
| 1-1/2 | 1.900 | .090 | 1.700 | .339 |
| 2 | 2.375 | .113 | 2.129 | .521 |
| 2-1/2 | 2.875 | .137 | 2.581 | .754 |
| 3 | 3.500 | .167 | 3.146 | 1.106 |
| 3-1/2 | 4.000 | .190 | 3.596 | 1.443 |
| 4 | 4.500 | .214 | 4.046 | 1.825 |
| 5 | 5.563 | .265 | 5.001 | 2.792 |
| 6 | 6.625 | .316 | 5.955 | 3.964 |

For additional information call: 610-275-4453 or Fax: 610-279-6299
Please call for current prices.

POLYETHYLENE PIPE - super strong plastic pipe

**Custom length coils
available on
special order**

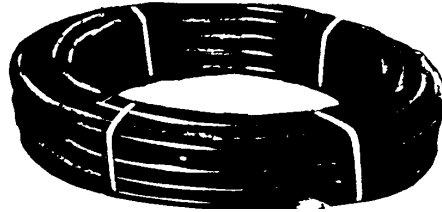

| SDR 15 100 PSI | | | | | | 100' COIL | | FULL COIL | |
|----------------|-------|-----------|---------------|------------------|-----------|-----------|-------|-----------|-------|
| SIZE | ID | MIN. WALL | WGHT PER 100' | MAX PSI @ 7.34°F | COIL LGTH | FIG. NO. | PRICE | FIG. NO. | PRICE |
| 3/4" | .824 | .060 | 7.4 | 100 | 100/400 | 15397 | | 15398 | |
| 1" | 1.049 | .070 | 10.6 | 100 | 100/300 | 15399 | | 15400 | |
| 1 1/4" | 1.380 | .092 | 18.5 | 100 | 100/300 | 15401 | | 15402 | |
| 1 1/2" | 1.610 | .107 | 25.5 | 100 | 100/250 | 15403 | | 15404 | |
| 2" | 2.067 | .138 | 41.7 | 100 | 100/200 | 15405 | | 15406 | |
| 3" | 3.068 | .205 | 88.0 | 100 | 100 | | | | |
| 4" | 4.026 | .268 | 126.0 | 100 | 20 | | | | |

| SDR 11.5 125 PSI | | | | | | 100' COIL | | FULL COIL | |
|------------------|-------|-----------|---------------|------------------|-----------|-----------|-------|-----------|-------|
| SIZE | ID | MIN. WALL | WGHT PER 100' | MAX PSI @ 7.34°F | COIL LGTH | FIG. NO. | PRICE | FIG. NO. | PRICE |
| 1/2" | | | | 125 | 100/400 | 47961 | | 47962 | |
| 3/4" | .824 | .072 | 9.0 | 125 | 100/400 | 15407 | | 15408 | |
| 1" | 1.049 | .091 | 14.1 | 125 | 100/300 | 15409 | | 15410 | |
| 1 1/4" | 1.380 | .120 | 24.5 | 125 | 100/300 | 15411 | | 15412 | |
| 1 1/2" | 1.610 | .140 | 33.5 | 125 | 100/250 | 15413 | | 15414 | |
| 2" | 2.067 | .180 | 55.5 | 125 | 100/200 | 15415 | | 15416 | |

| SDR 9 160 PSI | | | | | | 100' COIL | | FULL COIL | |
|---------------|-------|-----------|---------------|------------------|-----------|-----------|-------|-----------|-------|
| SIZE | ID | MIN. WALL | WGHT PER 100' | MAX PSI @ 7.34°F | COIL LGTH | FIG. NO. | PRICE | FIG. NO. | PRICE |
| 3/4" | .824 | .092 | 11.5 | 160 | 100/400 | 15417 | | 15418 | |
| 1" | 1.049 | .117 | 18.5 | 160 | 100/300 | 15419 | | 15420 | |
| 1 1/4" | 1.380 | .153 | 31.5 | 160 | 100/300 | 15421 | | 15422 | |
| 1 1/2" | 1.610 | .179 | 43.0 | 160 | 100/250 | 15423 | | 15424 | |
| 2" | | | | | 100/200 | 15425 | | 15426 | |

| SDR 7 200 PSI | | | | | | 100' COIL | | FULL COIL | |
|---------------|-------|-----------|---------------|------------------|-----------|-----------|-------|-----------|-------|
| SIZE | ID | MIN. WALL | WGHT PER 100' | MAX PSI @ 7.34°F | COIL LGTH | FIG. NO. | PRICE | FIG. NO. | PRICE |
| 1" | 1.049 | .150 | 25.0 | 200 | 100/300 | 42763 | | 42764 | |

INSERT FITTINGS FOR FLEXIBLE PIPE (NYLON AND PVC)

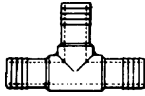
| | SIZE | FIG. NO. | PRICE |
|--|-------|----------|-------|
| TEE (Insert)  | PVC | | |
| | 1/2 | 10398 | |
| | 3/4 | 10401 | |
| | 1 | 10403 | |
| | 1 1/4 | 10407 | |
| | 1 1/2 | 10410 | |
| | 2 | 10414 | |
| | 3 | 28381 | |

SEE PUMP SECTION FOR STEEL AND STAINLESS STEEL FITTINGS!

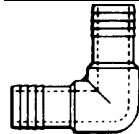
| | SIZE | FIG. NO. | PRICE |
|--|-------|----------|-------|
| INSERT 90° ELBOW  | PVC | | |
| | 1/2 | 10417 | |
| | 3/4 | 10420 | |
| | 1 | 10426 | |
| | 1 1/4 | 10431 | |
| | 1 1/2 | 10439 | |
| | 2 | 10444 | |
| | 3 | 28436 | |
| NYLON | | | |
| 3/4 | 61795 | | |
| 1 | 55890 | | |
| 1 1/4 | 62273 | | |

| | SIZE | FIG. NO. | PRICE |
|--|-----------|----------|-------|
| COMBO 90° ELBOW FEMALE  | PVC | | |
| | 1/2X1/2 | 10454 | |
| | 3/4X3/4 | 10458 | |
| | 1X1/2 | 38764 | |
| | 1X1 | 10463 | |
| | 1 1/4X1/4 | 10471 | |
| | 1 1/2X1/2 | 10478 | |

| | SIZE | FIG. NO. | PRICE |
|--|-------|----------|-------|
| COMBO 90° ELBOW FEMALE  | PVC | | |
| | 1/2 | 10495 | |
| | 3/4 | 10503 | |
| | 1 | 10511 | |
| | 1 1/4 | 10523 | |
| | 1 1/2 | 10526 | |
| 2 | 10531 | | |

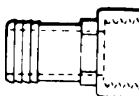
| | SIZE | FIG. NO. | PRICE |
|--|-------|----------|-------|
| FEMALE ADAPTER  | PVC | | |
| | 1/2 | 10648 | |
| | 3/4 | 10652 | |
| | 1 | 10656 | |
| | 1 1/4 | 10659 | |
| | 1 1/2 | 10662 | |
| 2 | 10666 | | |

| | SIZE | FIG. NO. | PRICE |
|---|-------|----------|-------|
| INSERT COUPLING  | PVC | | |
| | 1/2 | 10534 | |
| | 3/4 | 10541 | |
| | 1 | 10544 | |
| | 1 1/4 | 10550 | |
| | 1 1/2 | 10556 | |
| | 2 | 10563 | |
| | 3 | 26879 | |
| 4 | 26880 | | |
| NYLON | | | |
| 1 | 55891 | | |
| 1 1/4 | 60424 | | |

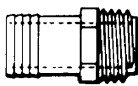
| | SIZE | FIG. NO. | PRICE |
|---|-------|----------|-------|
| MALE ADAPTER (Insert x MPT)  | PVC | | |
| | 1/2 | 10669 | |
| | 3/4 | 10676 | |
| | 1 | 10682 | |
| | 1 1/4 | 10691 | |
| | 1 1/2 | 10708 | |
| | 2 | 10714 | |
| | 3 | 25903 | |
| 4 | 25917 | | |
| NYLON | | | |
| 1 | 54284 | | |
| 1 1/4 | 62491 | | |



INDUSTRIAL STAINLESS STEEL CLAMPS

POW'R-GEAR Clamps, 60 series - provides the extra muscle you need for your high-torque applications. 150 inch lbs. of torque delivers over 800 lbs. of band tension. 10 to a box.

| MIN | MAX | FIG. NO. | PRICE/EA |
|-------|-------|----------|----------|
| 1 1/4 | 2 5/8 | 50729 | |
| 2 1/8 | 4 1/8 | 50730 | |
| 4 | 6 1/8 | 50731 | |
| 6 1/8 | 9 1/8 | 50732 | |



LOX-ON all stainless steel clamp. SIMPLIFY YOUR INVENTORY! ONE SIZE FITS 1/2"-2" PIPE. For Extra tough installations - the pump installers friend. 50 to a box.

| FIG. NO. | PRICE/EA |
|----------|----------|
| 9232 | |



Micro-clamp, all stainless steel clamp. 10 to a box.

| SIZE | FIG. NO. | PRICE |
|----------|----------|-------|
| 1/4-5/8 | 9234 | |
| 5/16-7/8 | 9235 | |

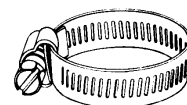

ALL STAINLESS STEEL CLAMP

Band and housing of 18-8 and 3/8" hex-head screw made of 400 series stainless. 10 to a box.

| SIZE NO. | SIZE RANGE | FIG. NO. | PRICE | SIZE NO. | SIZE RANGE | FIG. NO. | PRICE |
|----------|--------------|----------|-------|----------|----------------|----------|-------|
| 08 | 7/16-1 | 9212 | | 44 | 1 5/16-3 1/4 | 18072 | |
| 10 | 1/2-1 1/16 | 9214 | | 48 | 1 5/8-3 1/2 | 18071 | |
| 12 | 1/2-1 1/4 | 9216 | | 52 | 1 7/8-3 3/4 | 9228 | |
| 16 | 3/4-1 1/2 | 9218 | | 72 | 3/8 - 5 | 9229 | |
| 20 | 3/4-1 3/4 | 9219 | | 88 | 4 1/4 - 6 | 18074 | |
| 24 | 1-2 | 9220 | | 128 | 2 1/2 - 8 1/2 | 16316 | |
| 28 | 1 5/16-2 1/4 | 9222 | | 164 | 2 1/2 - 10 3/4 | 16320 | |
| 32 | 1 9/16-2 1/2 | 9223 | | 188 | 2 1/2 - 12 | 16322 | |
| 36 | 7/8-2 3/4 | 9226 | | 248 | 2 1/2 - 16 | 16324 | |
| 40 | 1 1/8-3 | 9227 | | | | | |

PLASTIC HOSE AND TUBING

CLEAR VINYL TUBING

All components of the PVC compound are sanctioned by the US Food and Drug Administration for good packaging applications under Title 21 of the Code of Federal Regulations.

Clear, flexible tubing is suitable for use in low pressure applications including drain lines, laboratory tubing, industrial, chemical and agricultural uses and food and beverages applications.

Has good chemical resistance to alkaline, ammonium compounds, brine, some acids and alcohols.

Temperature range: -5°F to 125°F

74 74+/- 5 duromet

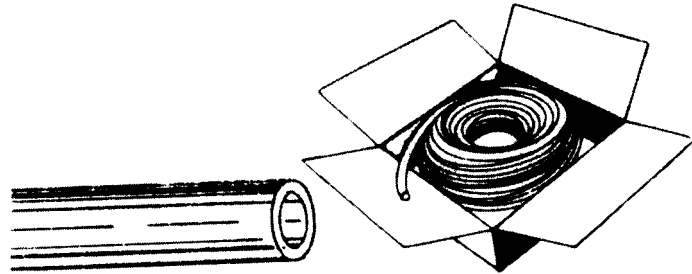

| ID | OD | WALL | W/P 68°F | FIG. NO. | PER FOOT | | PER COIL | |
|-------|-------|------|----------|----------|----------|-------------|----------|-------|
| | | | | | PRICE | Coil Length | FIG. NO. | PRICE |
| 1/8 | 3/16 | 1/32 | 50 | 11402 | | 100' | 17701 | |
| 3/16 | 5/16 | 1/16 | 60 | 11403 | | 100' | 17702 | |
| 1/4 | 3/8 | 1/16 | 50 | 11404 | | 100' | 17703 | |
| 5/16 | 7/16 | 1/16 | 50 | 11406 | | 100' | 17704 | |
| 3/8 | 1/2 | 1/16 | 45 | 11407 | | 100' | 17705 | |
| 1/2 | 5/8 | 1/16 | 30 | 11408 | | 100' | 17706 | |
| 5/8 | 7/8 | 1/8 | 30 | 11410 | | 100' | 17707 | |
| 3/4 | 1 | 1/8 | 25 | 11412 | | 100' | 17708 | |
| 7/8 | 1 1/8 | 1/8 | 35 | 38091 | | 100' | 51450 | |
| 1 | 1 1/4 | 1/8 | 25 | 11413 | | 100' | 17709 | |
| 1 1/4 | 1 5/8 | 3/16 | 30 | 11414 | | 50' | 17710 | |
| 1 1/2 | 1 7/8 | 3/16 | 30 | 11416 | | 50' | 17711 | |
| 2 | 2 1/2 | 1/4 | 30 | 11417 | | 50' | 17712 | |

REINFORCED VINYL TUBING



Food Grade

Features clear and flexible non-marking cover made with compounds shown on approved list.

Uses: transfer of air and water; drinking water pressure lines; any application in which transparent hose is required or desired.

Tube & Cover: Clear food grade PVC. Reinforced with high tensile strength yard.

Temperature range: 25°F to + 150°F; -5°C to +65°C

| ID | OD | WALL | W/P 68°F | FIG. NO. | PER FOOT | | PER COIL | |
|-------|-------|------|----------|----------|----------|-------------|----------|-------|
| | | | | | PRICE | Coil Length | FIG. NO. | PRICE |
| 3/16 | .375 | 250 | 1000 | 11384 | | 500' | 17689 | |
| 1/4 | .460 | 250 | 1000 | 11386 | | 500' | 17690 | |
| 5/16 | .525 | 250 | 1000 | 11389 | | 500' | 17691 | |
| 3/8 | .600 | 225 | 900 | 11390 | | 500' | 17692 | |
| 1/2 | .750 | 200 | 800 | 11392 | | 300' | 17694 | |
| 5/8 | .875 | 200 | 800 | 11393 | | 300' | 17695 | |
| 3/4 | 1.030 | 150 | 600 | 11395 | | 300' | 17696 | |
| 1 | 1.312 | 125 | 500 | 11397 | | 100' | 17697 | |
| 1 1/4 | 1.687 | 100 | 400 | 11398 | | 100' | 17698 | |
| 1 1/2 | 1.937 | 75 | 300 | 11399 | | 100' | 17699 | |
| 2 | 2.500 | 75 | 300 | 11401 | | 100' | 17700 | |

PLASTIC HOSE & TUBING (CONT'D)

POLY TUBE

Low density polyethylene tubing has a wide range of uses including water lines, beverage tubing, air lines, instrumentation, plus uses in industrial, agricultural and chemical applications.

Has good chemical resistance to alkalines, dilute acid, ammonia gas, ammonium hydroxide, brine water, and most aqueous solutions of metallic salts.

Natural compound meets the Food and Drug Administration Code of Federal Regulations, Title 21, Part 177, 1520 (c) 2.1 for a resin which may be processed for contact with human food.

Temperature range: -40°F to 136°F

Natural color: ASTM D-1248-84 Type 1, Class A, Category 4.

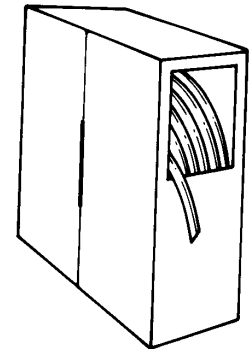
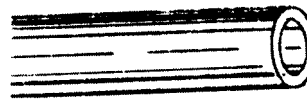

| | | | | PER FOOT | PER 100FT COIL | | |
|--|--|--|--|----------|----------------|--|--|
|--|--|--|--|----------|----------------|--|--|

| OD | ID | WALL | W/P 70°F | FIG. NO. | PRICE | FIG. NO. | PRICE |
|-------|------|-------|----------|----------|-------|----------|-------|
| 1/4" | .170 | .040 | 150 | 11418 | | 17713 | |
| 5/16" | .233 | .040 | 130 | 11419 | | 17714 | |
| 3/8" | .250 | .0625 | 125 | 11421 | | 17715 | |
| 1/2" | .375 | .0625 | 100 | 11422 | | 17716 | |
| 5/8" | .500 | .0625 | 70 | 11423 | | 17718 | |
| 3/4" | | | | 44590 | | 44589 | |
| 7/8" | | | | 47850 | | 47849 | |

FIBERGLASS GRATING

*Grating

*Floor Plate

*Structurals, Handrails & Platforms

*Ladders

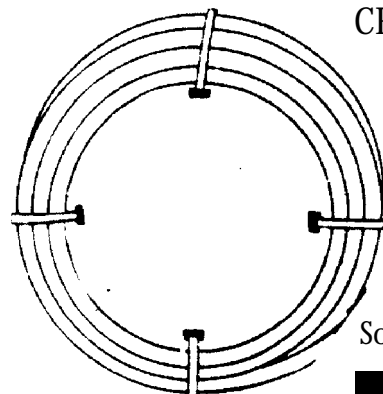

CREAMERY WASH DOWN HOSE (HOT WATER)

White EPDM cover resists scuffing, abrasion & cracking. Kink resistant handles hot water to 298°F. 3/4" ID x 1 1/4" OD Max. W.P. 200^o. Sold per foot.

| FIG. NO. | PRICE |
|----------|-------|
| 11373 | |

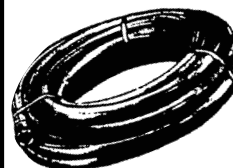

CONTRACTORS RUBBER WATER HOSE

Heavy duty black EPDM rubber. Heavy brass octagon coupling. 150 lb. working pressure.

| FIG. NO. | PRICE |
|-------------|-------|
| 3/4 X 25' | 11432 |
| 3/4" X 50' | 11434 |
| 3/4" X 100' | 40204 |

First quality

For additional information call: 610-275-4453 or Fax: 610-279-6299
Please call for current prices.

| | BRASS | | NYLON | |
|---|------------|----------|----------|-------|
| | SIZE | FIG. NO. | FIG. NO. | PRICE |
| HOSE BARB TO MALE PIPE | | | | |
|  | 1/8 X 1/8 | 4887 | - | |
| | 3/16 X 1/8 | 4890 | - | |
| | 3/16 X 1/4 | 4892 | - | |
| | 1/4 X 1/8 | 4894 | 4637 | |
| | 1/4 X 1/4 | 4895 | 4643 | |
| | 1/4 X 3/8 | 4897 | 26916 | |
| | 1/4 X 1/2 | - | 26917 | |
| | 5/16 X 1/4 | 4899 | - | |
| | 3/8 X 1/8 | 4900 | - | |
| | 3/8 X 1/4 | 4902 | 4649 | |
| | 3/8 X 3/8 | 4903 | 4652 | |
| | 3/8 X 1/2 | 4905 | 4654 | |
| | 1/2 X 1/4 | 4912 | 26915 | |
| | 1/2 X 3/8 | 4914 | 4656 | |
| | 1/2 X 1/2 | 4916 | 4659 | |
| | 1/2 X 3/4 | 4917 | 4661 | |
| | 5/8 X 3/8 | 4918 | 26912 | |
| | 5/8 X 1/2 | 4922 | 26913 | |
| | 5/8 X 3/4 | 4924 | 26914 | |
| | 3/4 X 1/2 | 4925 | 22631 | |
| 3/4 X 3/4 | 4927 | 21661 | | |
| 1 X 3/4 | 36209 | - | | |
| 1 X 1 | 36210 | - | | |

| | BRASS | | NYLON | |
|---|-----------|----------|----------|-------|
| | SIZE | FIG. NO. | FIG. NO. | PRICE |
| HOSE BARB X FEMALE PIPE | | | | |
|  | 1/4 X 1/4 | 4933 | 4689 | |
| | 3/8 X 1/4 | 4936 | - | |
| | 3/8 X 3/8 | 4939 | - | |
| | 1/2 X 1/2 | 4949 | 47324 | |

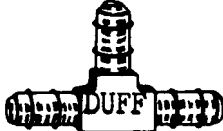
| | BRASS | | NYLON | |
|--|-------|----------|----------|-------|
| | SIZE | FIG. NO. | FIG. NO. | PRICE |
| UNION TEE TUBE ALL ENDS | | | | |
|  | 1/4 | - | 4682 | |
| | 3/8 | - | 4683 | |

| | BRASS | | NYLON | |
|---|-------|----------|----------|-------|
| | SIZE | FIG. NO. | FIG. NO. | PRICE |
| HOSE X HOSE SPLICER | | | | |
|  | 1/4 | 4951 | 4666 | |
| | 5/16 | - | 42458 | |
| | 3/8 | 4952 | 4669 | |
| | 1/2 | 4954 | 4671 | |
| | 3/4 | - | 42460 | |

| | BRASS | | NYLON | |
|---|-----------|----------|----------|-------|
| | SIZE | FIG. NO. | FIG. NO. | PRICE |
| HOSE BARB 90° ELBOW | | | | |
|  | 1/4 X 1/8 | - | 4673 | |
| | 1/4 X 1/4 | - | 4674 | |
| | 3/8 X 1/8 | - | 22154 | |
| | 3/8 X 1/4 | - | 4675 | |
| | 3/8 X 3/8 | - | 4676 | |
| | 1/2 X 1/4 | - | 26918 | |
| | 1/2 X 3/8 | - | 4678 | |
| | 1/2 x 1/2 | - | 4680 | |
| | 1/2 x 3/4 | - | 55638 | |
| | 5/8 X 3/8 | - | 39052 | |
| 5/8 X 1/2 | - | 55416 | | |



**BUYING QUALITY
PRODUCTS
IS LIKE BUYING
OATS . . .**

If you want nice, clean, fresh oats,
you must pay a fair price. However,
if you can be satisfied with oats that
have already been through the horse

Well . . . That Comes A Little Cheaper

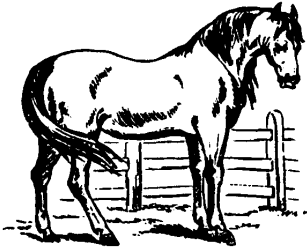



NYLON TUBING FITTINGS AND CONNECTORS

| | OD | PIPE THRD- | FIG. NO. | PRICE |
|---|------|------------|----------|-------|
|  | 1/8 | 1/8 | 3559 | |
| | 1/4 | 1/8 | 3564 | |
| | 1/4 | 1/4 | 3565 | |
| | 1/4 | 3/8 | 3567 | |
| | 5/16 | 1/8 | 47104 | |
| | 5/16 | 1/4 | 3569 | |
| | 3/8 | 1/8 | 22282 | |
| | 3/8 | 1/4 | 3570 | |
| | 3/8 | 3/8 | 3571 | |
| | 3/8 | 1/2 | 47105 | |
| | 1/2 | 1/4 | 29584 | |
| | 1/2 | 3/8 | 3572 | |
| | 1/2 | 1/2 | 3575 | |
| | 5/8 | 3/8 | 24097 | |
| | 5/8 | 1/2 | 3576 | |
| | 3/4 | 1/2 | 3577 | |
| | 3/4 | 3/4 | 29585 | |
| | 7/8 | 3/4 | 47106 | |

| | OD | PIPE THRD- | FIG. NO. | PRICE |
|---|------|------------|----------|-------|
|  | 1/4 | 1/4 | 3579 | |
| | 5/16 | 5/16 | 29587 | |
| | 5/16 | 1/4 | 29588 | |
| | 3/8 | 3/8 | 3581 | |
| | 3/8 | 1/4 | 29589 | |
| | 1/2 | 1/2 | 3583 | |
| | 1/2 | 3/8 | 29590 | |
| 5/8 | 5/8 | 3585 | | |

| | OD | PIPE THRD- | FIG. NO. | PRICE |
|---|------|------------|----------|-------|
|  | 1/4 | 1/4 | 3628 | |
| | 5/16 | 5/16 | 3630 | |
| | 3/8 | 3/8 | 3631 | |
| | 1/2 | 1/2 | 3635 | |
| | 5/8 | 5/8 | 3638 | |

| | OD | PIPE THRD- | FIG. NO. | PRICE |
|---|------|------------|----------|-------|
|  | 1/4 | 1/4 | 3590 | |
| | 1/4 | 1/8 | 42455 | |
| | 1/4 | 3/8 | 3592 | |
| | 5/16 | 1/4 | 3593 | |
| | 3/8 | 1/4 | 3596 | |
| | 3/8 | 3/8 | 3599 | |
| | 1/2 | 3/8 | 3600 | |
| | 1/2 | 1/2 | 3604 | |
| | 5/8 | 3/8 | 48970 | |
| | 5/8 | 1/2 | 3606 | |

| | OD | PIPE THRD- | FIG. NO. | PRICE |
|---|-----|------------|----------|-------|
|  | 1/4 | 1/8 | 29617 | |
| | 1/4 | 1/4 | 29618 | |
| | 3/8 | 1/4 | 29620 | |
| | 3/8 | 3/8 | 29621 | |
| | 1/2 | 3/8 | 29622 | |
| | 1/2 | 1/2 | 29624 | |
| 5/8 | 1/2 | 29625 | | |

| | OD | PIPE THRD- | FIG. NO. | PRICE |
|--|-----|------------|----------|-------|
|  | 1/4 | 1/4 | 3609 | |
| | 3/8 | 3/8 | 3611 | |
| | 1/2 | 1/2 | 3612 | |
| | 5/8 | 5/8 | 3614 | |

| | OD | PIPE THRD- | FIG. NO. | PRICE |
|---|-----|------------|----------|-------|
|  | 1/4 | 1/4 | 29595 | |
| | 5/8 | 1/2 | 29601 | |

| | OD | PIPE THRD- | FIG. NO. | PRICE |
|---|------|------------|----------|-------|
|  | 1/4 | 1/4 | 29604 | |
| | 5/16 | 1/4 | 29605 | |
| | 3/8 | 1/4 | 29606 | |
| | 3/8 | 3/8 | 29608 | |
| | 1/2 | 3/8 | 29609 | |
| | 1/2 | 1/2 | 29610 | |
| | 5/8 | 1/2 | 29611 | |

| | OD | PIPE THRD- | FIG. NO. | PRICE |
|---|------|------------|----------|-------|
|  | 1/4 | 1/4 | 3616 | |
| | 5/16 | 1/4 | 29592 | |
| | 3/8 | 1/4 | 3617 | |
| | 3/8 | 3/8 | 3619 | |

| | OD | PIPE THRD- | FIG. NO. | PRICE |
|---|------|------------|----------|-------|
|  | 1/4 | 1/4 | 3675 | |
| | 5/16 | 5/16 | 3678 | |
| | 3/8 | 3/8 | 3682 | |
| | 1/2 | 1/2 | 3685 | |

| | OD | PIPE THRD- | FIG. NO. | PRICE |
|--|------|------------|----------|-------|
|  | 1/4 | 1/4 | 3641 | |
| | 5/16 | 5/16 | 3642 | |
| | 3/8 | 3/8 | 3644 | |
| | 1/2 | 1/2 | 3647 | |
| | *1/4 | 1/4 | 3649 | |
| | *3/8 | 3/8 | 3660 | |
| | *1/2 | 1/2 | 3663 | |
| | *5/8 | 5/8 | 64617 | |
| *6mm | 6mm | 64155 | | |

*provided with SS Gripper



HOSE

STEAM HOSE

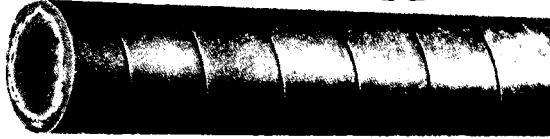

Kink-proof, flexible hose designed to convey saturated steam with safety. Reinforced with steel wire and glass cord and specially compounded cover. Sold by the foot, can be made up with fittings!

| ID | OD | MAX WP, LBS | BRAID | FIG. NO. | PRICE |
|-----|---------|-------------|-------|----------|-------|
| 1/2 | 1 1/8 | 200 | 2 | 11424 | |
| 3/4 | 1 13/32 | 200 | 2 | 11426 | |
| 1 | 1 21/32 | 200 | 2 | 11427 | |



AUTOMATIC WATER-SAVER SPRAY NOZZLE

The Strahman spray nozzle does a better job with the least amount of water. This precision made nozzle enables the operator to get any type stream of water to do his job by simply pressing the lever. A soft spray is sent forth with slight pressure on the lever, and a strong straight stream may be had by pushing the lever all the way down. This convenient control of the waste water assures better cleaning with a lot less effort. The nozzle automatically shuts off the moment the lever is released, thereby eliminating all waste water.

| Fig. No. | Price |
|----------|-------|
| 30906 | |



HYDRAULIC HOSE ASSEMBLIES

1-WIRE, 2-WIRE braid. Meets all requirements of SAE100R1 and SAE 100R2. 1-wire hose (100R1) recommended for medium pressure and 2-wire hose (100R2) for high pressure hydraulic service. Both ends coupled with solid male IPT couplings. Each assembly is "sleeved" for easy handling and shelf storage. CALL FOR PRICING!

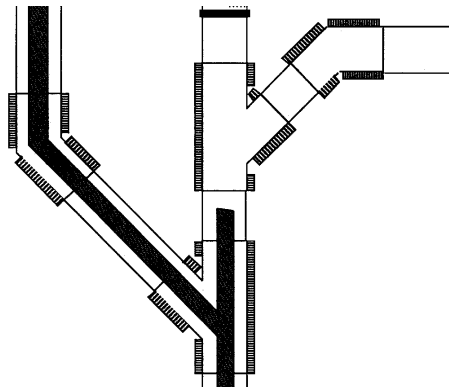

**DOUBLE CONTAINMENT
PIPING SYSTEMS**

Call for Quotes!
610-275-4453

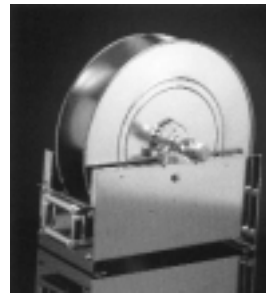

HOSE REELS BY

Q REELCRAFT

**HOSE REELS FOR AIR, WATER AND
OTHER LIQUIDS**

MANY STYLES AVAILABLE

For additional information call: 610-275-4453 or Fax: 610-279-6299.
Please call for current prices.

SUCTION & DISCHARGE HOSE

PVC SUCTION HOSE

Green

Smooth bore and cover

Reinforced with a tough, rigid PVC helix to withstand crushing, kinking, and vacuum pressures.

Highly resistant to ozone, weather, salt and alkaline

Temperature range form +15⁰ to 150⁰F.

Full 100' coils are also available!

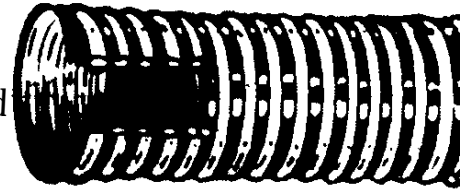

| SIZE | PER FOOT (STANDARD COILS 20', 25', 50', 100') | | 20' WITH SHANK COUPLING | | 20' WITH C&E QUICK CONNECTS | |
|-------|--|-------|----------------------------|-------|--------------------------------|-------|
| | FIG. NO. | PRICE | FIG. NO. | PRICE | FIG. NO. | PRICE |
| 1 | 17719 | | - | | - | |
| 1 1/4 | 11302 | | 11311 | | 47011 | |
| 1 1/2 | 11303 | | 11316 | | 47012 | |
| 2 | 11304 | | 11318 | | 47013 | |
| 3 | 11305 | | 11320 | | 47014 | |
| 4 | 11306 | | 11322 | | 47015 | |



RUBBER SUCTION HOSE

Smooth SBR bore & cover

Black with green stripe

Full 100' coils available!

Coupled lengths are also available upon your request!

Priced per foot

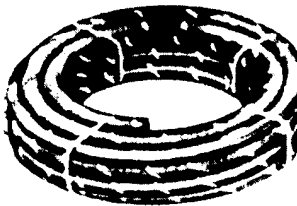

| ID | OD | FIG. NO. | PRICE (PER FT) |
|--------|----------|----------|-------------------|
| 1 1/2" | 2-3/8" | 40123 | |
| 2" | 2-9/16" | 40124 | |
| 3" | 3-9/16" | 40125 | |
| 4" | 4-11/16" | 40126 | |
| 6" | 7" | 40127 | |

Available with shank couplers or quick connects!

PVC LAY FLAT DISCHARGE HOSE

Blue polyvinyl tube and cover with synthetic fiber reinforcement.

Will not rot or mildew.

Coils flat for easy handling, storage and shipping

Continuous 1 piece lengths

Temperature range from 4⁰F to 122⁰F

Coupled lengths are also available upon your request!

Also available in full 300' lengths!

Priced per foot

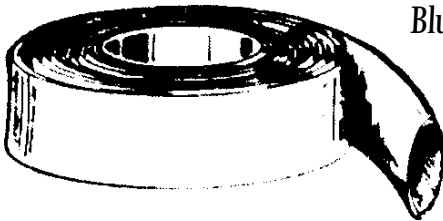

| ID | WP/PSI | FIG. NO. (Per Foot) | PRICE |
|--------|--------|---------------------|-------|
| 1 1/4" | | 11359 | |
| 1 1/2" | 80 | 11360 | |
| 2" | 80 | 11361 | |
| 3" | 70 | 11362 | |
| 4" | 70 | 11363 | |

HOSE ACCESSORIES

SIZE FIG. NO. PRICE
SUCTION HOSE STRAINERS

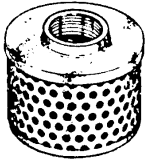

| | |
|-------|------|
| 1 1/2 | 4602 |
| 2 | 4608 |
| 2 1/2 | 4610 |
| 3 | 4613 |
| 4 | 4616 |
| 6 | 4617 |

SHANK COUPLINGS

1" furnished with octagon nut
 1 1/2" thru 2" furnished with lugs on female only.
 2 1/2" thru 6" have lugs on both male and female sides

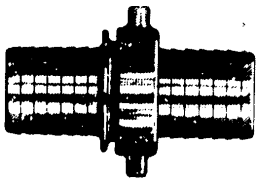

| | |
|-------|------|
| 1 1/2 | 4564 |
| 2 | 4566 |
| 2 1/2 | 4568 |
| 3 | 4570 |
| 4 | 4572 |
| 6 | 4574 |

SIZE FIG. NO. PRICE
FOOT VALVE



Painted Cast Iron

| | |
|-------|-------|
| 1 1/2 | 10589 |
| 2 | 10592 |
| 3 | 10597 |
| 4 | 10600 |
| 6 | 10604 |

SHANK COUPLING WASHER



Rubber

| | |
|-------|-------|
| 3/4 | 48898 |
| 1 | 48899 |
| 1 1/4 | 48900 |
| 1 1/2 | 48901 |
| 2 | 48902 |
| 2 1/2 | 48903 |
| 3 | 48904 |
| 4 | 48905 |

**DUFF IS ALWAYS
 OPEN**

**365 DAYS A YEAR
 24 HR EMERGENCY SERVICE!**

SIZE FIG. NO. PRICE
COMBINATION HOSE NIPPLE



King Nipple
 Cadmium plated steel

| | |
|-------|-------|
| 1/2 | 49163 |
| 3/4 | 49153 |
| 1 | 49154 |
| 1 1/4 | 49155 |
| 1 1/2 | 49156 |
| 2 | 49157 |
| 2 1/2 | 49158 |
| 3 | 49159 |
| 4 | 49160 |
| 5 | 49161 |
| 6 | 49162 |
| 8 | 60201 |

COMBINATION HOSE NIPPLE



**STAINLESS
 STEEL**

King Nipple
 Stainless Steel

| | |
|-------|-------|
| 1/2 | 49164 |
| 3/4 | 49165 |
| 1 | 49166 |
| 1 1/4 | 49167 |
| 1 1/2 | 49168 |
| 2 | 49169 |





**YOU ARE
 ALWAYS
 WELCOME
 AT DUFF
 COMPANY!**

**VISIT US
 ANYTIME!**

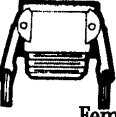
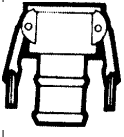
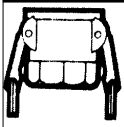

QUICK DISCONNECT COUPLINGS & ADAPTERS

FITTINGS AVAILABLE TO 6" !

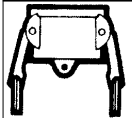
| | | ALUMINUM | | BRASS | | IRON | | STAINLESS STEEL | | POLY | |
|---|-------|----------|-------|----------|-------|----------|-------|-----------------|-------|----------|-------|
| | | FIG. NO. | PRICE | FIG. NO. | PRICE | FIG. NO. | PRICE | FIG. NO. | PRICE | FIG. NO. | PRICE |
|  <p>A Male Adapter FPT X Male Coupler</p> | 3/4 | 3800 | | 4230 | | 34103 | | 34178 | | 4428 | |
| | 1 | 3804 | | 4231 | | 34104 | | 34179 | | 4430 | |
| | 1 1/4 | 3808 | | 4233 | | 34105 | | 34180 | | | |
| | 1 1/2 | 3812 | | 4234 | | 33799 | | 34181 | | 4433 | |
| | 2 | 3813 | | 4260 | | 34107 | | 34182 | | 4435 | |
| | 3 | 3824 | | 4261 | | 34109 | | 34183 | | 4438 | |
|  <p>B Female Coupler Coupler X MPT</p> | 3/4 | 3836 | | 4265 | | 34113 | | 34186 | | 4450 | |
| | 1 | 3839 | | 4267 | | 34114 | | 34187 | | 4452 | |
| | 1 1/4 | - | | 4268 | | 34115 | | 34188 | | - | |
| | 1 1/2 | 3846 | | 4269 | | 34116 | | 34189 | | 4456 | |
| | 2 | 3847 | | 4271 | | 34117 | | 34190 | | 4458 | |
| | 3 | 3853 | | 4274 | | 34119 | | 34191 | | 4460 | |
|  <p>C Hose Shank Coupler Fem Coupler X Hose Shank</p> | 3/4 | 3957 | | 4278 | | 34123 | | 34194 | | 4466 | |
| | 1 | 3959 | | 4279 | | 34124 | | 34195 | | 4469 | |
| | 1 1/4 | 4146 | | 4281 | | 34125 | | 34196 | | - | |
| | 1 1/2 | 3963 | | 4282 | | 34126 | | 34197 | | 4474 | |
| | 2 | 3966 | | 4283 | | 34127 | | 34198 | | 4479 | |
| | 3 | 3970 | | 4291 | | 34129 | | 34199 | | 4480 | |
|  <p>D Fem Coupler Fem Coupler X FPT</p> | 3/4 | 3974 | | 4295 | | 34133 | | 34202 | | 4483 | |
| | 1 | 4051 | | 4296 | | 34134 | | 34203 | | 4485 | |
| | 1 1/4 | 4054 | | 4298 | | 34135 | | 34204 | | - | |
| | 1 1/2 | 4056 | | 4299 | | 33800 | | 34205 | | 4490 | |
| | 2 | 4057 | | 4302 | | 34136 | | 34206 | | 4492 | |
| | 3 | 4074 | | 4304 | | 34138 | | 34207 | | 4499 | |
|  <p>E Hose Shank Adapter Male Coupler X Hose Shank</p> | 3/4 | 4092 | | 4312 | | 34142 | | 34210 | | 4504 | |
| | 1 | 4094 | | 4314 | | 34143 | | 34211 | | 4505 | |
| | 1 1/4 | 4097 | | 4315 | | 34144 | | 34212 | | - | |
| | 1 1/2 | 4099 | | 4316 | | 34145 | | 34213 | | 4510 | |
| | 2 | 4103 | | 4317 | | 34146 | | 34214 | | 4515 | |
| | 3 | 4106 | | 4319 | | 34147 | | 34216 | | 4517 | |
|  <p>F Male Adapter MPT X Male Coupler</p> | 3/4 | 4184 | | 4324 | | 34151 | | 34219 | | 4520 | |
| | 1 | 4185 | | 4325 | | 34152 | | 34220 | | 4521 | |
| | 1 1/4 | 4193 | | 4326 | | 34153 | | 34221 | | - | |
| | 1 1/2 | 4194 | | 4327 | | 34154 | | 34222 | | 4554 | |
| | 2 | 4196 | | 4328 | | 34155 | | 34223 | | 4530 | |
| | 3 | 4199 | | 4330 | | 34157 | | 34224 | | 4534 | |
|  <p>DP Dust Plug Male Coupler</p> | 3/4 | - | | 4359 | | 34160 | | 34226 | | 4551 | |
| | 1 | - | | 4385 | | 34161 | | 34227 | | 4552 | |
| | 1 1/4 | - | | 4387 | | 34162 | | 34228 | | - | |
| | 1 1/2 | - | | 4390 | | 33801 | | 34229 | | 4557 | |
| | 2 | 4224 | | 4395 | | 34163 | | 34230 | | 4559 | |
| | 3 | 4227 | | 4398 | | 34165 | | 34231 | | 4560 | |
|  <p>DC Dust Cap Female Coupler</p> | 3/4 | 4204 | | 4334 | | 34168 | | 34233 | | 4541 | |
| | 1 | 4205 | | 4336 | | 34169 | | 34234 | | 4544 | |
| | 1 1/4 | - | | 4343 | | 34170 | | 34235 | | - | |
| | 1 1/2 | - | | 4346 | | 34171 | | 34236 | | 4546 | |
| | 2 | 4209 | | 4348 | | 34172 | | 34237 | | 4548 | |
| | 3 | 4212 | | 4352 | | 34174 | | 34238 | | 4549 | |
| | 4 | 4214 | | 4355 | | 34175 | | 34239 | | - | |

A - Excellent
 B - Good
 C - Good to 80°F
 D - Moderate effect
 Use under limited conditions
 E - Not Recommended
 F - Autocatalytic
 X - Unknown

CHEMICAL RESISTANCE GUIDE INDUSTRIAL CHEMICALS

| CHEMICAL | CPVC | PVC | Ryton | Polypropylene | Polyethylene | Lucite | Acrylic | Teflon | SS 316 | CARP 20 | EPDM | Silastic | Ceramic | Hypalon | Viton |
|-----------------------|------|-----|-------|---------------|--------------|--------|---------|--------|--------|---------|------|----------|---------|---------|-------|
| ACE TALDEHYDE | E | E | A | C | X | E | E | A | A | A | A | B | A | E | A |
| ACETIC ACID, 20% | B | B | A | A | B | A | A | A | A | A | A | B | A | A | E |
| ACETIC ACID, 80% | D | D | A | B | B | D | D | A | A | A | B | D | A | A | E |
| ACETIC ACID, GLACIAL | E | D | A | C | A | E | E | A | A | A | A | X | A | E | E |
| ACETIC ANHYDRIDE | E | E | A | A | X | E | E | A | D | C | B | E | A | A | E |
| ACETONE | E | E | A | B | D | E | E | A | A | A | A | D | A | D | E |
| ALUMINUM CHLORIDE | A | A | A | A | A | A | A | A | D | D | A | D | A | A | A |
| ALUMINUM FLUORIDE | A | A | A | A | X | A | A | A | C | D | A | D | X | A | A |
| ALUMINUM SULFATE | A | A | A | A | A | A | A | A | D | B | A | X | A | A | A |
| AMMONIA, 10% | A | A | A | A | B | A | A | A | A | A | B | E | A | A | A |
| AMMONIUM CHLORIDE | A | A | A | A | A | A | A | A | D | C | A | X | A | A | A |
| AMMONIUM NITRATE | A | A | A | A | X | A | A | A | A | A | A | X | A | A | A |
| AMMONIUM PERSULFATE | A | A | A | A | X | A | A | A | C | B | A | X | A | A | A |
| AMMONIUM PHOSPHATE | A | A | A | A | X | A | A | A | A | A | A | A | A | A | A |
| AMMONIUM SULFATE | A | A | A | A | A | A | A | A | B | A | A | X | A | B | B |
| AMYL ACETATE | E | E | A | E | E | E | E | A | A | A | A | E | A | E | E |
| AMYL ALCOHOL | B | B | X | X | X | E | E | A | A | A | B | E | A | B | B |
| AMYL CHLORIDE | E | E | A | X | X | E | E | A | C | A | A | E | A | E | A |
| ANILINE | E | E | A | C | D | E | E | A | A | A | A | X | A | B | A |
| AQUA REGIA | E | E | X | X | D | E | E | A | E | E | D | X | A | B | A |
| ARSENIC ACID | A | A | A | A | X | A | A | A | X | B | A | A | A | X | A |
| BARIUM CHLORIDE | A | A | A | A | X | A | A | A | C | B | A | A | A | B | B |
| BARIUM SULFATE | A | A | A | A | X | A | A | A | B | B | A | A | A | A | A |
| BEER | A | A | A | A | B | A | A | A | A | A | A | A | A | A | A |
| BENZALDEHYDE | E | E | A | C | X | E | E | A | A | A | A | E | A | E | E |
| BENZENE (BENZOL) | E | E | A | C | E | E | E | A | A | A | E | E | A | E | D |
| BENZOIC ACID | A | A | A | A | A | C | C | A | B | B | X | D | A | E | A |
| BORAX (SODIUM BORATE) | A | A | A | A | D | X | X | A | A | A | A | D | A | B | B |
| BORIC ACID | A | A | A | A | A | A | A | A | A | A | A | A | A | B | B |
| BROMINE WATER | C | C | D | E | X | X | X | A | E | E | D | E | A | E | A |
| BUTYL ACETATE | E | E | A | E | X | X | X | A | B | B | C | E | A | E | E |
| BUTYRIC ACID | D | D | X | A | X | D | D | A | B | A | B | X | A | E | D |
| CALCIUM BISULFITE | A | A | A | A | A | X | X | A | B | B | E | A | A | A | A |
| CALCIUM CHLORIDE | A | A | A | A | A | A | A | A | C | A | A | A | A | A | A |
| CALCIUM HYPOCHLORITE | A | A | A | A | A | A | A | A | D | D | B | D | A | A | D |
| CALCIUM SULFATE | A | A | A | A | X | A | A | A | B | B | B | D | A | A | A |
| CARBON TETRACHLORIDE | C | C | A | C | E | X | X | A | B | B | X | E | A | E | A |
| CARBONIC ACID | A | A | A | A | X | A | A | A | B | A | A | X | E | A | B |
| CHLOROACETIC ACID | A | A | A | D | X | E | E | A | E | X | E | X | A | A | A |
| CHLORINE WATER | A | A | A | E | B | X | X | A | E | B | B | X | A | B | A |
| CHLOROBENZENE | E | E | A | C | X | E | E | A | A | A | E | E | A | E | A |
| CHLOROFORM | E | E | A | E | X | E | E | A | A | A | E | E | A | E | D |
| CHLOROSULFONIC ACID | C | C | E | E | E | E | E | A | D | D | E | X | A | X | E |
| CHROMIC ACID, 10% | A | A | A | A | A | A | A | A | B | A | E | D | A | A | A |
| CHROMIC ACID, 30% | A | A | A | A | A | A | A | A | B | A | E | E | A | A | A |
| CHROMIC ACID, 50% | E | E | D | A | B | D | D | A | C | B | E | E | A | A | A |
| CITRIC ACID | A | A | A | A | A | A | A | A | B | A | A | B | A | A | A |
| COPPER CHLORIDE | A | A | A | A | B | A | A | A | B | B | B | B | A | B | B |
| COPPER CYANIDE | A | A | A | A | X | A | A | A | A | B | B | A | X | B | B |
| COPPER NITRATE | A | A | A | A | X | A | A | A | A | B | A | A | B | B | B |
| COPPER SULFATE | A | A | A | A | A | A | A | A | B | A | B | B | A | B | B |
| CRESYLIC ACID | B | B | X | X | X | X | X | A | A | A | E | X | A | X | A |
| ETHYL ACETATE | E | E | A | C | X | E | E | A | B | B | D | D | A | E | E |
| ETHYL CHLORIDE | E | E | A | E | X | E | E | A | A | A | B | E | A | D | A |
| ETHYLENE GLYCOL | A | A | A | A | X | A | A | A | B | A | B | A | A | B | B |
| FATTY ACIDS | A | A | A | A | E | D | D | A | A | A | X | D | A | X | B |
| FERRIC CHLORIDE | A | A | A | A | A | A | A | A | E | E | A | B | A | B | B |

- Excellent
- Good
- Good to 80°F
- Moderate effect
- Use under limited conditions
- Not Recommended
- Autocatalytic
- Unknown

CHEMICAL RESISTANCE GUIDE INDUSTRIAL CHEMICALS

| CHEMICAL | CpVC | PVC | Ryton | Polypropylene | Polyethylene | Lucite | Acrylic | Teflon | SS 316 | CARP 20 | EPDM | Silastic | Ceramic | Hypalon | Viton |
|----------------------------|------|-----|-------|---------------|--------------|--------|---------|--------|--------|---------|------|----------|---------|---------|-------|
| FERRIC NITRATE | A | A | A | A | E | A | A | A | B | A | A | D | A | B | B |
| FERRIC SULFATE | A | A | A | A | E | A | A | A | A | A | A | D | A | B | B |
| FERROUS CHLORIDE | A | A | A | A | A | A | A | A | E | E | B | X | A | B | B |
| FERROUS SULFATE | A | A | A | A | B | A | A | A | D | B | B | X | A | B | B |
| FLUOBORIC ACID | A | A | A | A | E | B | B | A | B | A | B | X | E | B | X |
| FLUOSILICIC ACID | A | A | A | A | A | B | B | A | B | B | X | X | E | X | B |
| FORMALDEHYDE, 40% | B | B | A | A | B | A | A | A | A | A | A | X | A | B | E |
| FORMIC ACID | C | C | A | A | B | E | E | A | B | A | B | D | A | B | E |
| FREON 12 (WET) | C | C | X | A | X | X | X | A | E | X | D | E | A | E | A |
| FUEL OILS | A | A | A | C | X | X | X | A | A | A | E | E | A | B | B |
| FURFURAL | E | E | A | E | X | X | X | A | B | A | D | X | A | X | E |
| GASOLINE | C | C | A | E | X | E | E | A | A | A | E | E | A | E | A |
| GLYCERINE (GLYCEROL) | A | A | A | A | X | A | A | A | A | A | A | A | A | B | B |
| HEPTANE | A | A | A | C | X | X | X | A | A | A | X | E | A | B | B |
| HEXANE | C | C | A | C | X | X | X | A | A | A | E | X | A | B | B |
| HYDROBROMIC ACID, 20% | A | A | A | A | B | X | X | A | E | E | B | E | C | A | A |
| HYDROCHLORIC ACID, 0-25% | A | A | A | A | B | A | A | A | E | E | C | E | C | A | B |
| HYDROCHLORIC ACID, 25-37% | A | A | A | A | B | A | B | A | E | E | C | E | C | A | A |
| HYDROCYANIC ACID | A | A | A | A | B | A | B | A | A | A | B | E | C | X | A |
| HYDROFLUORIC ACID, 10% | C | C | A | A | A | A | B | A | C | C | B | E | E | A | A |
| HYDROFLUORIC ACID, 30% | C | C | A | B | D | D | E | A | C | C | C | E | E | A | A |
| HYDROFLUORIC ACID, 60% | D | D | C | B | E | D | E | A | C | C | D | E | E | D | A |
| HYDROFLUOSILICIC ACID, 20% | A | A | A | A | A | B | D | A | B | B | A | E | E | X | B |
| HYDROGEN PEROXIDE, 30% | A | A | B | A | B | A | B | A | B | A | D | A | X | A | A |
| HYDROGEN PEROXIDE, 50% | C | C | D | X | B | X | X | A | B | A | E | B | X | A | A |
| HYDROGEN PEROXIDE, 90% | E | E | D | X | D | X | E | A | B | A | E | B | X | D | A |
| HYDROGEN SULFIDE, AQ. SOL. | C | C | A | A | X | A | B | A | B | A | A | D | X | B | B |
| IODINE (IN ALCOHOL) | E | E | A | C | E | X | E | A | B | B | E | E | A | E | A |
| KEROSENE | B | B | A | C | X | A | X | A | A | A | E | E | A | E | A |
| KETONES | E | E | A | E | X | E | E | A | A | A | X | X | A | E | E |
| LACQUER THINNERS | D | D | A | C | X | E | E | A | A | A | E | E | A | X | X |
| LACTIC ACID | B | B | A | A | A | D | E | A | B | A | A | B | A | B | B |
| LEAD ACETATE | A | A | A | A | X | A | A | A | A | A | A | E | A | E | A |
| LUBRICATING OIL | C | C | A | C | D | A | A | A | A | A | E | E | A | D | A |
| MAGNESIUM CHLORIDE | A | A | A | A | A | A | A | A | B | A | A | A | A | A | A |
| MAGNESIUM NITRATE | A | A | A | A | X | A | A | A | A | A | B | B | A | A | A |
| MAGNESIUM SULFATE | A | A | A | A | A | A | A | A | A | A | A | A | A | A | A |
| MALEIC ACID | A | A | A | A | X | X | E | A | B | A | E | X | A | A | A |
| METHYL ALCOHOL | C | C | X | A | E | X | E | A | A | A | B | A | A | B | D |
| METHYL CHLORIDE | E | E | X | E | X | E | E | A | A | A | D | X | A | E | A |
| METHYL ETHYL KETONE | E | E | A | C | X | E | E | A | A | A | B | D | A | E | E |
| METHYL ISOBUTYL KETONE | E | E | A | C | X | E | E | A | A | A | D | D | A | E | E |
| METHYLENE CHLORIDE | E | E | X | E | X | E | E | A | A | A | E | X | A | E | D |
| NAPHTHA | B | B | A | C | X | E | E | A | A | A | E | E | A | E | A |
| NAPHTHALENE | E | E | A | C | X | X | E | A | A | A | E | E | A | E | D |
| NICKEL CHLORIDE | A | A | A | A | A | A | A | A | B | B | A | B | A | B | B |
| NICKEL SULFATE | A | A | A | A | A | A | A | A | B | A | A | A | A | B | B |
| NITRIC ACID, 10% | A | A | A | A | A | D | E | A | B | A | D | B | A | A | A |
| NITRIC ACID, 20% | A | A | A | A | B | E | E | A | B | A | E | D | A | A | A |
| NITRIC ACID, 50% | A | A | C | C | C | E | E | A | B | A | E | E | A | E | A |
| NITRIC ACID, ANHYDROUS | E | E | D | E | E | E | E | A | B | A | X | E | A | E | B |
| NITRO BENZENE | E | E | A | C | X | E | E | A | B | A | E | E | A | E | E |
| OILS AND FATS | A | A | A | A | X | X | X | A | A | A | E | X | A | X | A |
| OLEIC ACID | A | A | A | C | E | X | E | A | B | B | D | X | A | D | D |
| OLEUM, 25% | E | E | X | X | E | E | E | A | X | X | X | X | A | E | A |
| OXALIC ACID | A | A | A | A | B | D | D | A | C | B | B | D | A | A | A |
| PHENOL | C | C | A | B | C | A | A | A | B | B | D | D | A | E | A |

- A - Excellent
- B - Good
- C - Good to 80°F
- D - Moderate effect
- E - Use under limited conditions
- F - Not Recommended
- X - Autocatalytic
- Unknown

CHEMICAL RESISTANCE GUIDE INDUSTRIAL CHEMICALS

| CHEMICAL | CPVC | PVC | Ryton | Polypropylene | Polyethylene | Lucite | Acrylic | Teflon | SS 316 | CARP 20 | EPDM | Silastic | Ceramic | Hypalon | Viton |
|--------------------------|------|-----|-------|---------------|--------------|--------|---------|--------|--------|---------|------|----------|---------|---------|-------|
| PHOSPHORIC ACID, 0-50% | A | A | A | A | A | A | B | A | B | B | D | E | A | A | B |
| PHOSPHORIC ACID, 50-100% | B | B | A | B | B | A | D | A | B | B | E | E | A | A | B |
| POTASSIUM BICARBONATE | A | A | A | A | B | A | A | A | B | B | A | X | A | B | B |
| POTASSIUM BROMIDE | A | A | A | A | B | A | A | A | B | B | A | X | A | B | B |
| POTASSIUM CARBONATE | A | A | A | A | B | A | A | A | B | B | A | X | A | B | B |
| POTASSIUM CHLORATE | A | A | A | A | B | A | A | A | A | A | B | B | A | B | B |
| POTASSIUM CHLORIDE | A | A | A | A | A | A | A | A | D | C | A | B | A | B | B |
| POTASSIUM CYANIDE | A | A | A | A | X | A | A | A | A | B | B | A | A | B | B |
| POTASSIUM DICHROMATE | A | A | A | A | B | A | A | A | A | A | B | A | A | B | B |
| POTASSIUM HYDROXIDE | A | A | A | A | A | D | E | A | B | B | D | D | E | B | B |
| POTASSIUM NITRATE | A | A | A | A | A | A | A | A | B | B | B | A | A | B | B |
| POTASSIUM PERMANGANATE | A | A | A | A | A | A | A | A | B | B | B | B | A | B | B |
| POTASSIUM SULFATE | A | A | A | A | A | A | A | A | B | B | A | A | A | B | B |
| PROPYL ALCOHOL | C | C | X | X | X | X | X | A | A | A | B | A | A | B | B |
| SOAPS | A | A | A | A | C | A | A | A | A | A | A | A | A | B | B |
| SODIUM ACETATE | A | A | A | A | A | A | A | A | B | B | A | X | A | A | E |
| SODIUM BICARBONATE | A | A | A | A | A | A | A | A | B | A | A | A | A | B | B |
| SODIUM BISULFATE | A | A | A | A | A | A | A | A | A | A | A | A | A | B | B |
| SODIUM BISULFITE | A | A | A | A | A | A | A | A | B | B | A | B | A | B | B |
| SODIUM CARBONATE | A | A | A | A | A | A | A | A | B | A | B | A | A | B | B |
| SODIUM CHLORATE | A | A | A | A | A | A | A | A | B | B | B | X | A | B | B |
| SODIUM CHLORIDE | A | A | A | A | A | A | A | A | B | B | B | A | A | B | B |
| SODIUM CYANIDE | A | A | A | A | X | A | A | A | A | A | B | B | A | B | B |
| SODIUM HYDROXIDE, 20% | A | A | A | A | A | D | D | A | A | A | B | D | E | B | E |
| SODIUM HYDROXIDE, 50% | A | A | A | A | B | D | E | A | A | A | C | D | E | B | E |
| SODIUM HYPOCHLORITE | A | A | A | A | A | A | A | A | D | X | B | D | A | A | D |
| SODIUM NITRATE | A | A | A | A | A | A | A | A | A | A | A | E | A | B | B |
| SODIUM SILICATE | A | A | A | A | A | A | A | A | B | B | A | X | A | A | A |
| SODIUM SULFATE | A | A | A | A | A | A | A | A | A | A | A | A | A | B | B |
| SODIUM SULFIDE | A | A | A | A | A | A | A | A | B | B | B | X | A | B | B |
| STANNIC CHLORIDE | A | A | A | A | A | A | A | A | E | C | D | D | A | D | B |
| STEARIC ACID | A | A | A | C | E | X | E | A | A | A | D | A | A | D | A |
| STODDARDS SOLVENT | E | E | A | X | X | X | X | A | A | A | E | E | X | X | A |
| SULFURIC ACID, 0-10% | A | A | A | A | A | A | D | A | E | A | D | E | A | A | A |
| SULFURIC ACID, 10-75% | A | A | B | A | C | D | E | A | E | A | E | E | A | A | A |
| SULFURIC ACID, 75-100% | C | C | C | C | C | E | E | A | E | A | E | E | A | D | A |
| TANNIC ACID | A | A | A | A | B | X | X | A | B | B | B | D | A | B | B |
| TANNING LIQUORS | A | A | A | A | A | X | X | A | A | A | E | X | A | X | A |
| TARTARIC ACID | A | A | A | A | X | X | E | A | B | B | D | B | A | B | B |
| TETRAHYDROFURANE | E | E | A | C | X | X | E | A | A | A | D | X | A | X | X |
| TOLUENE (TOLUOL) | E | E | A | C | E | E | E | A | A | A | E | X | A | E | E |
| TRICHLOROETHYLENE | E | E | A | C | E | X | X | A | B | B | E | X | A | E | A |
| TRICRESYLPHOSPHATE | E | E | A | X | X | X | X | A | A | A | B | X | A | E | A |
| TURPENTINE | B | B | A | C | X | X | X | A | A | A | E | X | A | E | A |
| UREA | A | A | A | A | X | X | X | A | B | B | X | X | A | A | E |
| VINEGAR | A | A | A | A | A | A | A | A | A | A | A | B | A | B | B |
| WHITE LIQUOR (ACID) | A | A | A | X | X | X | E | A | A | A | X | X | A | X | A |
| XYLENE (XYLOL) | E | E | A | E | E | E | E | A | A | A | E | E | A | E | A |
| ZINC CHLORIDE | A | A | A | A | A | A | A | A | B | A | A | X | A | B | B |
| ZINC SULFATE | A | A | A | A | A | A | A | A | A | A | A | A | A | A | A |

The following pages are offered as a general guide and indication of the suitability of various elastomers in use today for service in these chemicals and fluids. The ratings are based, for the most part, on published literature of various polymer suppliers and rubber manufacturers but, in some cases, they are the considered opinion of experienced compounds. We cannot guarantee their accuracy nor assume responsibility for use thereof.

AIR LINE PRODUCTS

GENERAL PURPOSE LUBRICATORS

1/4" - 3/8" - 1/2" - 3/4" - 1" - 1 1/4" - 1 1/2"

High performance over a very wide flow range. These lubricators are ideal for those OEM applications where space is a key consideration.

BENEFITS

Lubricator is fillble while under pressure
Rate of lubricator is automatically proportioned to airflow eliminating readjustment.

General Purpose Lubricator Performance Data

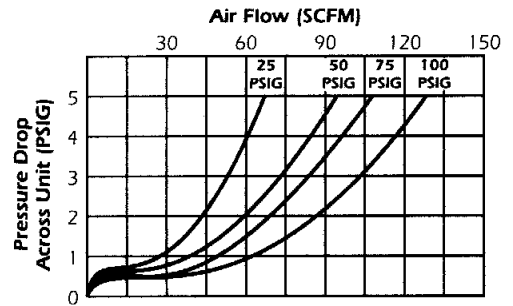

This chart shows typical performance characteristics under normal operating conditions.

| FIG. NO. | PORT SIZE | BOWL TYPE | PRICE |
|-----------|-----------|---------------------------------------|-------|
| 11264 | 1/4" | Polycarbonate with plastic bowl guard | |
| 11266 | 3/8" | Polycarbonate with plastic bowl guard | |
| 11270 | 1/2" | Polycarbonate with plastic bowl guard | |
| 11292 | 3/4" | | |
| 11294 | 1" | | |
| DL606-10W | 1 1/4" | | |
| DL606-12W | 1 1/2" | | |

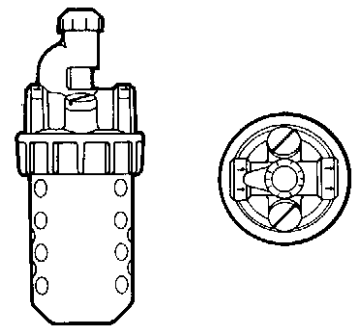

Pressure range 140 PSI max, Temperature Range 40° - 120°F

OPTIONS: Zinc Bowl with Sight Glass, Steel Bowl, Steel Bow with Sight glass

GENERAL PURPOSE FILTERS

Standard features include 40 micron polypropylene element, zinc body and manual drain.

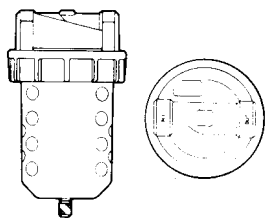

| SIZE | FIG. NO. | PRICE |
|------|----------|-------|
| 1/4" | 11287 | |
| 3/8" | 11289 | |
| 1/2" | 11290 | |
| 3/4" | 11292 | |
| 1" | 11294 | |

5 MICRON ELEMENT FEATURE ALSO AVAILABLE!

ASME RELIEF VALVES APPLICATIONS

ASME air relief valve, high capacity series. ASME coded national board capacity certified, designed to protect air receivers and other unfired pressure vessels. Factory set and sealed.

SPECIFY PRESSURE SETTING AT TIME OF ORDER!

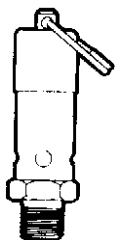

| FIG. NO. | SIZE | MATERIAL | PRICE |
|----------|------|---------------------|-------|
| D159-02 | 1/4" | Metal to metal seat | |
| D159-03 | 3/8" | Metal to metal seat | |
| D159-04 | 1/2" | Metal to metal seat | |

AIR LINE PRODUCTS
GENERAL PURPOSE
FILTERS/REGULATORS

1/4" - 3/8" - 1/2" SERIES

High capacity performance featuring rugged design for the most demanding applications. Ideal for those installations calling for constant pressure with wide variation in flow.

STANDARD FEATURES

- *Reduced pressure range: 2-125 psig (.15-8.5 BAR)
- *Supply pressure: 300 psig max (20.4 BAR)
- *Temperature range: 40o-120oF (4.4o-48.9oC)
- *Brass bottom plug
- *Diaphragm operated
- *Zinc body
- *Relieving
- *Aluminum spring cage
- *Spring adjustment mechanism

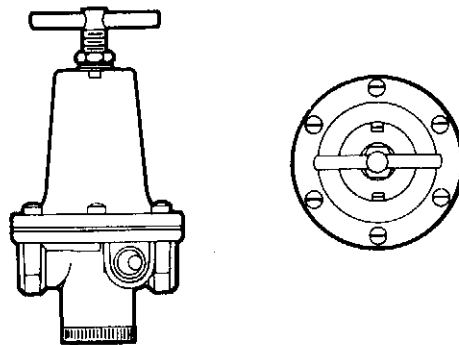

| SIZE | FIG. NO. |
|------|----------|
| 1/4" | 11275 |
| 3/8" | 11279 |
| 1/2" | 11281 |
| 3/4" | 11283 |
| 1" | 11285 |



AIR HOSE
 EPDM tube & cover
 Red smooth

Acceptable for spraying, including Monstanto's Lasso.
 Fittings attached to your specs, please inquire!
 Full 500' reels are available!

| ID | OD | COLOR | WP PSI | FIG. NO. | PRICE |
|------|---------|-------|--------|----------|-------|
| 1/4" | 19/32" | RED | 250 | 11374 | |
| 3/8" | 23/32" | RED | 250 | 11376 | |
| 1/2" | 7/8" | RED | 250 | 11377 | |
| 3/4" | 1-5/32" | RED | 250 | 11379 | |
| 1" | 1-1/2" | RED | 250 | 20741 | |

| COILS WITH FITTINGS! | |
|----------------------|-------|
| | |
| FIG. NO. | PRICE |
| 1/4" X 25' | 11380 |
| 1/4" X 50' | 38604 |

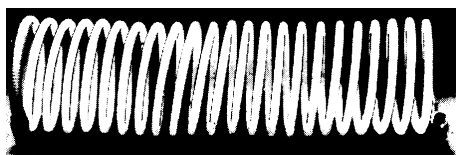

NYLON RECOIL HOSE

Yellow coupled. Stretches and recoils just like a telephone cord. Highest quality brass fittings, oil proof, abrasion resistant. Allows full flow of air. Recoils out of the way. Lightweight. 200LB. W/P. 1/4" ID solid x solid.

| Fig. No. | Price |
|----------|-------|
| 3791 | |

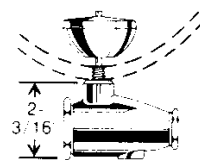

EXTERNAL AUTO DRAIN

| Fig. No. | Price |
|----------|-------|
| SA602D | |



SAFETY BLOW GUN

| Fig. No. | Price |
|----------|-------|
| 3797 | |



“AIR CHIEF” INDUSTRIAL QUICK-CONNECT FITTINGS



INDUSTRIAL INTERCHANGE



“Air-Chief” industrial quick-connect fittings are of the popular industrial interchange design and will interchange with many other makes. Rated 300 PSI.



SEMI-AUTOMATIC



Couplers automatically shut-off when uncoupled.



| 1/4" PLUGS | Size | Fig. No. | Price |
|---|-------------------|----------|-------|
|  | MALE NPT | | |
| | 1/8 | 30867 | |
| | 1/4 | 3688 | |
|  | FEMALE NPT | | |
| | 1/8 | 30868 | |
| | 1/4 | 3698 | |
|  | HOSE SHANK | | |
| | 1/4 | 3702 | |
| | 5/16 | 30869 | |
| | 3/8 | 3707 | |

| 1/4" COUPLERS | Size | Fig. No. | Price |
|--|-------------------|----------|-------|
|  | MALE NPT | | |
| | 1/8 | 30879 | |
| | 1/4 | 3730 | |
|  | FEMALE NPT | | |
| | 1/8 | 30891 | |
| | 1/4 | 3735 | |
|  | HOSE SHANK | | |
| | 1/4 | 3742 | |
| | 5/16 | 30880 | |
| | 3/8 | 3746 | |

| 3/8" PLUGS | Size | Fig. No. | Price |
|---|-------------------|----------|-------|
|  | MALE NPT | | |
| | 1/4 | 3710 | |
| | 3/8 | 3715 | |
|  | FEMALE NPT | | |
| | 1/4 | 3719 | |
| | 3/8 | 3720 | |
|  | HOSE SHANK | | |
| | 1/4 | 3724 | |
| | 3/8 | 3727 | |
| | 1/2 | 30871 | |

| 3/8" COUPLERS | Size | Fig. No. | Price |
|--|-------------------|----------|-------|
|  | MALE NPT | | |
| | 1/4 | 3748 | |
| | 3/8 | 3751 | |
|  | FEMALE NPT | | |
| | 1/4 | 3753 | |
| | 3/8 | 3757 | |
|  | HOSE SHANK | | |
| | 1/4 | 3761 | |
| | 3/8 | 3764 | |
| | 1/2 | 30882 | |

| 1/2" PLUGS | Size | Fig. No. | Price |
|---|-------------------|----------|-------|
|  | MALE NPT | | |
| | 3/8 | 30872 | |
| | 1/2 | 30873 | |
|  | FEMALE NPT | | |
| | 3/8 | 30875 | |
| | 1/2 | 30876 | |
|  | HOSE SHANK | | |
| | 3/8 | 24763 | |
| | 1/2 | 25243 | |
| | 3/4 | 30878 | |

| 1/2" COUPLERS | Size | Fig. No. | Price |
|--|-------------------|----------|-------|
|  | MALE NPT | | |
| | 3/8 | 30883 | |
| | 1/2 | 24762 | |
|  | FEMALE NPT | | |
| | 3/8 | 30885 | |
| | 1/2 | 30886 | |
|  | HOSE SHANK | | |
| | 3/8 | 30888 | |
| | 1/2 | 30889 | |
| | 3/4 | 30890 | |

FUME SCRUBBERS

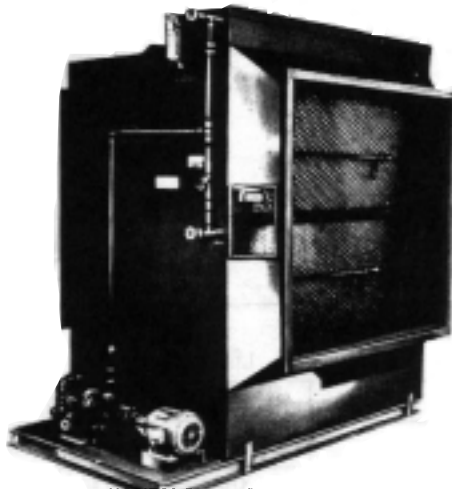

HORIZONTAL TYPE

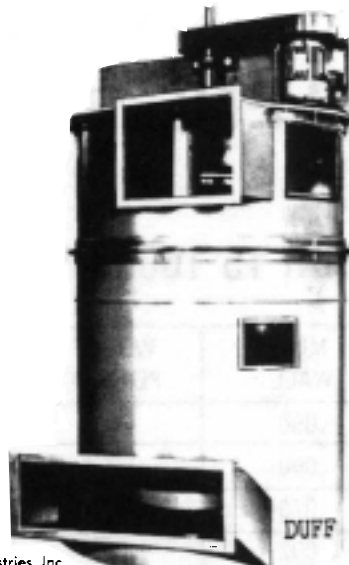

VERTICAL PACK TYPE

Courtesy Duall Industries, Inc.



MIST ELMINATOR

The fume scrubbers shown here are four stage, wet type. They have maximum efficiency on water soluble contaminants, but are also effective on low soluble contaminants with the use of chemical neutralizers. Horizontal unit combines reasonable cost with excellent efficiency. Vertical pack tower type illustrated is a compact scrubber-blower combination, saving both space and installation expense. Mist eliminator in fume scrubber assures properly dried air. It has either vertically or horizontally mounted PVC eliminator blades which provide four 30° changes in direction and eliminate entrained water.

**STANDARD
CORROSIVE
FUME HANDLING
EQUIPMENT**

REINFORCED FUME SCRUBBER

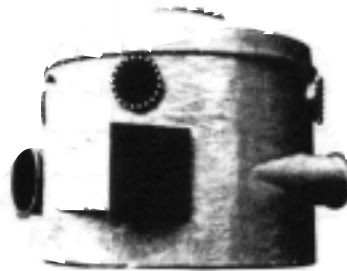

Typical Type G fume scrubber is fabricated from PVC and overlaid with fiberglass reinforced plastic to provide additional structural strength for larger-sized units.

FANS

**UTILITY FAN
(Up to 2250 CFM)**

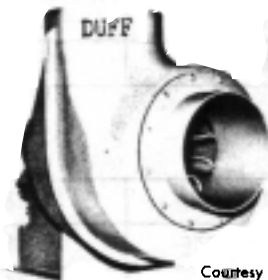

**TUBEAXIAL FAN
(Up to 25,000 CFM)**



Courtesy Industrial Plastic Fabricators, Inc.



**CENTRIFUGAL FAN
(294-3815 CFM)**

Courtesy Duall Industries, Inc.

**CENTRIFUGAL FAN
688-55,400 CFM)**

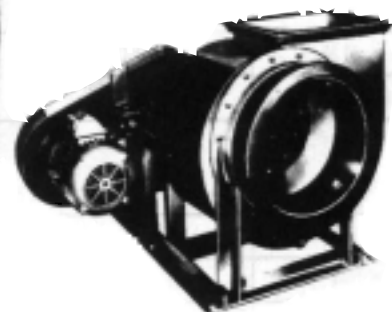

TOOLS

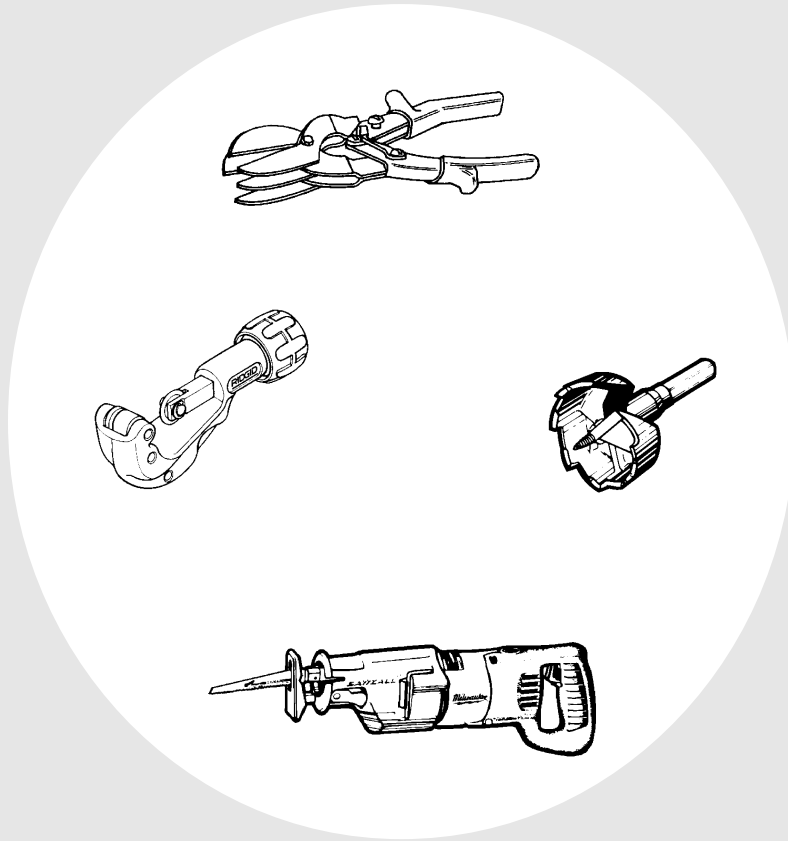

TOOLS

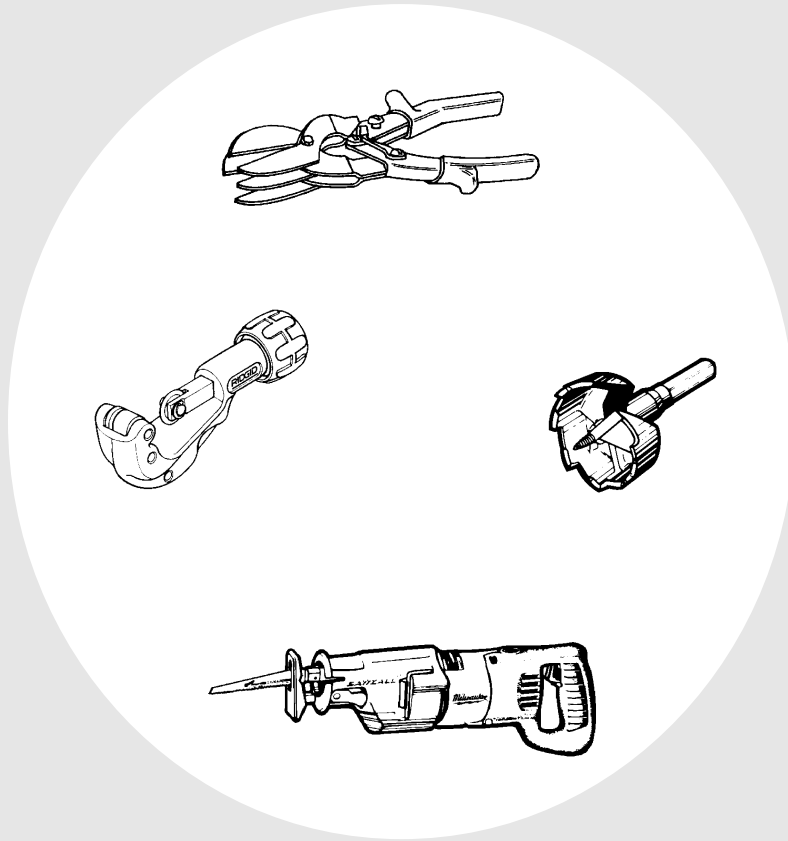

MILWAUKEE TOOLS

Heavy-Duty 12 Volt Power-Plus 3/8" Driver/Drill

- Powerful 12 volt rare earth motor develops 220 in./lbs. maximum torque.
- 2.0 amp-hr. battery packs deliver 24.0 watt-hrs. of power.
- Two speed ranges: 0-400/0-1,100 rpm.
- Variable speed switch with electronic brake.
- 0502-21 includes: Tool, two battery packs, charger and steel carrying case.

| Part No. | Description | Wt. | | Fig. No. | Price |
|-------------------|--|------|--|----------|-------|
| | | Lbs | | | |
| MIL0502-21 | Heavy-Duty, 12 Volt Power-Plus 3/8" Driver/Drill | 3.80 | | 71441 | |

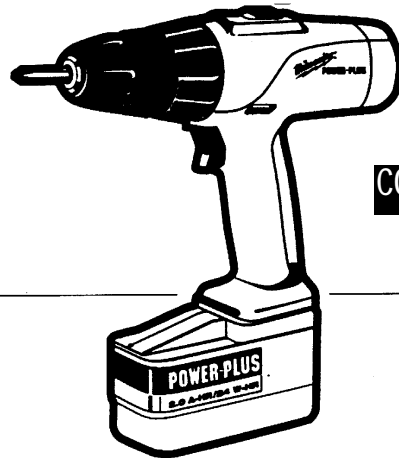

CORDLESS!

Milwaukee Cordless 14.4 Volt Power-Plus 1/2" Driver Drill

Use the 19 position clutch to better control screw torque and depth settings. There are two speed ranges. The 0-450 RPM range can be used when extra torque is required to drive larger screws. The 0-1250 RPM range is for general purpose drilling and screw driving. This kit includes drill, two power-plus 14.4 volt battery packs, power-plus charges, and impact-resistant carrying case.

| Part No. | Length | Weight | | Shipping | Fig. No. | Price |
|-------------------|--------|--------|------------|----------|----------|-------|
| | | Lbs. | Wt. (lbs.) | | | |
| MIL0511-21 | 11" | 4.75 | 13.75 | | 71439 | |

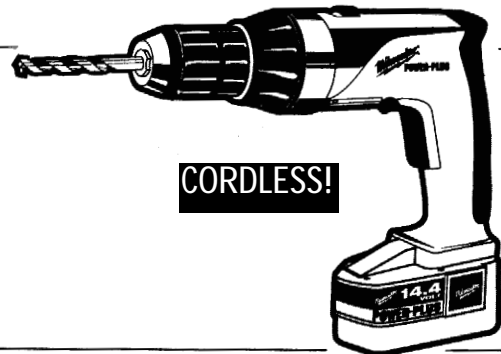

CORDLESS!

Milwaukee Cordless 14.4 Volt Power-Plus 1/2" Hammer-Drill

This ergonomically balanced hammer drill delivers more power to the work than conventional ceramic motors. Develops 280 in./lbs. maximum torque. There is a reversible battery pack which creates clearance to fit into cramped, tight work spaces and allows user to adjust balance. It includes the drill, two power-plus 14.4 volt battery packs, power-plus charger and impact-resistant carrying case.

| Part No. | Length | Weight | | Shipping | Fig. No. | Price |
|-------------------|--------|--------|------------|----------|----------|-------|
| | | Lbs. | Wt. (lbs.) | | | |
| MIL0513-21 | 11" | 5.25 | 14.25 | | 71440 | |



CORDLESS!

Heavy-Duty 1/2" Cordless Drills

- 1/2" 0-600 rpm.
- 12 volt, 270 in.-lbs. of torque
- Variable speed switch with electric brake.
- 2.0 amp-hr Super-Tough battery provides 40% more run time.
- Powerful, rare-earth DC motor with replaceable brushes..
- 0431-6 Includes: two Super Tough batteries, super charger, keyless chuck, side handle, steel carrying case.

| Part No. | Description | Wt. | | Fig. No. | Price |
|------------------|----------------------------------|-----|--|----------|-------|
| | | Lbs | | | |
| MIL0431-6 | Heavy-Duty, 1/2" Cordless Drills | 5.6 | | 57719 | |

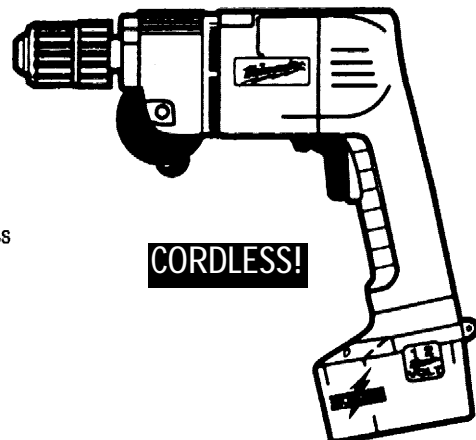

CORDLESS!

MILWAUKEE TOOLS

Milwaukee Hole Shooter

For heavy-duty industrial/construction applications. This hole shooter features trigger speed control reversing, all ball and roller bearings, and helical cut heat treated gears. 3.5 amp motor, and a speed of 0-1000 RPM.

| Part No. | Maximum Capacity | Length | Weight Lbs. | Shipping Wt. | Fig. No. | Price |
|------------|------------------|--------|-------------|--------------|----------|-------|
| MIL 0228-6 | 3/8" | 9 1/4" | 3 3/4 | 5 lbs. | 26686 | |

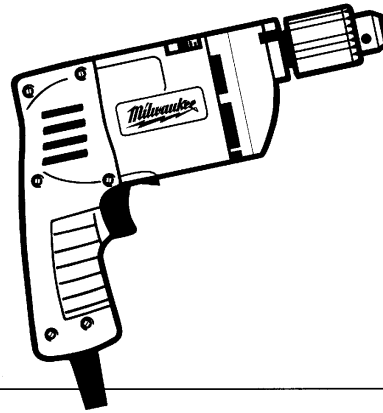

Milwaukee Heavy Duty 3/8" Drill

This 5.2 amp variable speed and reversing drill has a speed of 0-1200 RPM. Exclusive brush cartridge system lets you change brushes in less than one minute. Comes with chuck key, a rubber flex key holder, a side handle, and an 8' Quik-Lok Cord for tangle-free carrying and storing.

| Part No. | Maximum Capacity | Length | Weight Lbs. | Shipping Wt. | Fig. No. | Price |
|------------|------------------|---------|-------------|--------------|----------|-------|
| MIL 0224-1 | 3/8" | 10 1/2" | 4 3/4 | 6 lbs. | 16751 | |

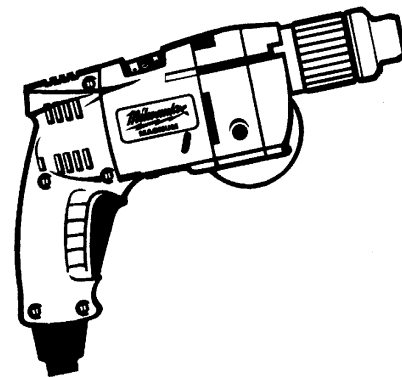

Magnum® Heavy Duty 1/2" Hole Shooter

These powerful 5.2 amp hole shooters have a keyless power chuck and feature trigger speed control reversing. The Model 0235-1 has a speed of 0-850 rpm. The Model 0244-1 has a speed of 0-600 rpm. Both have a double gear train and all ball and roller bearings. Change brushes in less than one minute with the exclusive brush cartridge system. Comes with an 8' Quik-Lok Cord for tangle-free carrying and storing.

| Part No. | Maximum Capacity | Length | Weight Lbs. | Shipping Wt. | Fig. No. | Price |
|------------|------------------|---------|-------------|--------------|----------|-------|
| MIL 0234-6 | 1/2" | 10 1/2" | 4 7/8 | 6 lbs. | 19784 | |

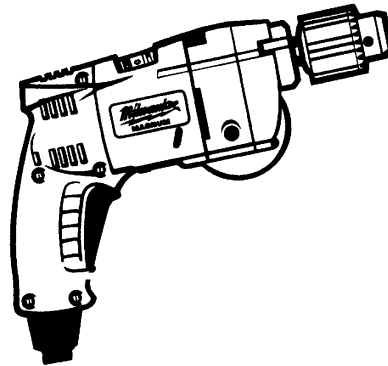

Milwaukee Heavy Duty 1/4" Hole Shooter

This hole shooter has a 3.5 amp motor and a speed of 0-2500 RPM. Features trigger speed control reversing, and all ball and roller bearings. Comes with a chuck key and a rubber flex key holder.

| Part No. | Maximum Capacity | Length | Weight Lbs. | Shipping Wt. | Fig. No. | Price |
|------------|------------------|--------|-------------|--------------|----------|-------|
| MIL 0102-1 | 1/4" | 8 3/8" | 3 1/2 | 4 1/2 lbs. | 16756 | |

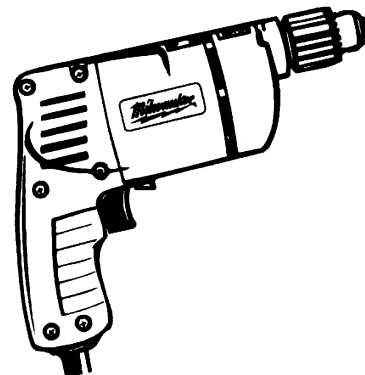

MILWAUKEE TOOLS

3/4" Super Hole-Shooter

This ruggedly built 350 rpm drill has reserve power for the toughest drilling jobs. Gears are helical cut for quiet performance, heat treated chrome moly alloy steel for high torque transmission with minimum wear. Comes with a 3/4" chuck.

| Part No. | Length | Tool Wt. | Shipping Wt. | Fig. No. | Price |
|-----------|---------|----------|--------------|----------|-------|
| MIL1854-1 | 18 1/2" | 19 lbs. | 23 lbs. | 26710 | |

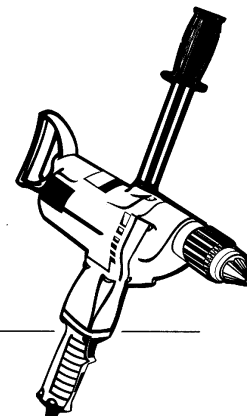

3/8" Magnum® Hole-Shooter

This 5.2 amp variable speed and reversing drill has a speed of 0-1200 rpm. Exclusive brush cartridge system lets you change brushes in less than one minute. Comes with chuck key, rubber flex key holder, side handle, and 8' Quik-Lok Cord for tangle-free carrying and storing.

| Part No. | Capacity | Maximum Length | Tool Wt. | Shipping Wt. | Fig. No. | Price |
|-----------|----------|----------------|-----------|--------------|----------|-------|
| MIL0224-1 | 3/8" | 10" | 47/8 lbs. | 6 lbs. | 16751 | |

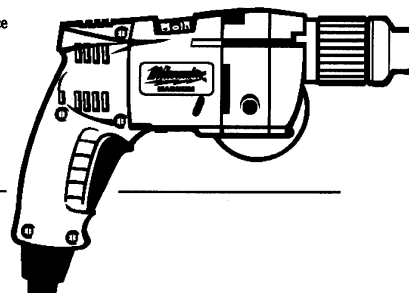

1/2" "D" Handle Hole-Shooters

This NEW hole-shooter has a redesigned 7 amp motor for increased power and performance. It has a NEW and improved helical cut for quiet performance.

| Part No. | Maximum Capacity | RPM | Length | Tool Wt. | Shipping Wt. | Fig. No. | Price |
|-----------|------------------|-------|---------|------------|--------------|----------|-------|
| MIL1101-1 | 1/2" | 500 | 14 3/4" | 6 1/2 lbs. | 10 1/2 lbs. | 19811 | |
| MIL1107-6 | 1/2" | 0-500 | 14 3/4" | 6 1/2 lbs. | 10 1/2 lbs. | 26696 | |

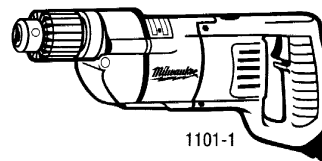
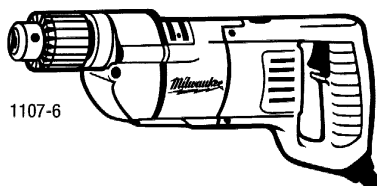

1/2" Reversing Right Angle Drill Kit

This NEW hole-shooter has a redesigned 7 amp motor for increased power and performance. It has a NEW and improved helical cut for quiet performance. Head and handle swivels 360° and can be locked tight in any position.

| Part No. | Maximum Capacity | Shipping Wt. | Fig. No. | Price |
|-----------|------------------|--------------|----------|-------|
| MIL3107-6 | 1/2" | 21 1/2 lbs. | 26716 | |

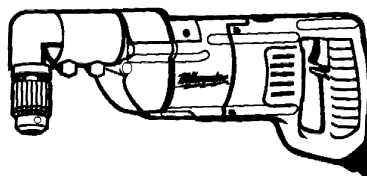

Cordless Power-Plus 1/2" Reversing Right Angle Drill

This is an essential tool for HVAC contractors, plumbers, electricians, maintenance workers and remodelers. The head and handle swivel 360° and can be locked tight in any position. It has a powerful 18 volt rechargeable battery. Includes R.A.D. assembly unit.

| Part No. | Maximum Capacity | Weight Lbs. | Shipping Wt. (lbs.) | Fig. No. | Price |
|------------|------------------|-------------|---------------------|----------|-------|
| MIL3108-21 | 1/2" | 10.75 | 22.5 | 84899 | |

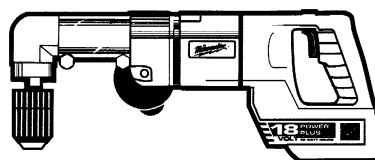

CORDLESS!

MILWAUKEE TOOLS

Milwaukee Right Angle Plumber's Drill Kit

A heavy-duty right angle drill kit designed for the mechanical contractor. It features a Model 1101-1 heavy duty "D" handle Hole Shooter with a 7.0 amp 120V (AC only) single-speed motor with a 1/2" steel capacity and a speed of 500 rpm. With right angle drive, open end wrench, socket wrench, chuck remover bar, side handle and steel carrying case.

| Part No. | Description | RPM w/RAD | | Gear Train | Shipping Wt. (lbs.) | Fig. No. | Price |
|------------|---------------|-----------|------|------------|---------------------|----------|-------|
| | | Low | High | | | | |
| MIL 3102-6 | Plumber's Kit | 335 | 750 | Triple | 21 | 16775 | |

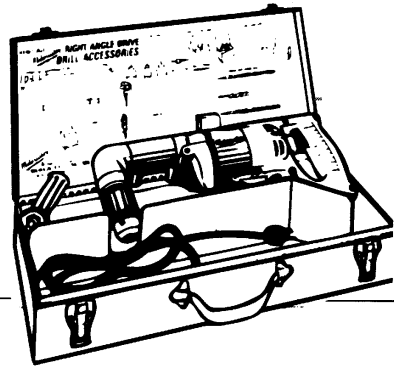

Milwaukee Keyless Chuck Hole Shooter

No chuck keys needed to change bits! Exclusive hand-activated ratcheting mechanism drives all three jaws to a powerful grip! 1/2" chuck capacity, 5 amp motor with a speed of 0-850 RPM. Trigger speed control reversing switches. Double gear train. Comes equipped with a side handle.

| Part No. | Spindle | | Weight Lbs. | Shipping Wt. (lbs.) | Fig. No. | Price |
|------------|-----------|---------|-------------|---------------------|----------|-------|
| | Thread | Length | | | | |
| MIL 0239-1 | 1/2" - 20 | 10 1/2" | 5 | 6 | 45277 | |

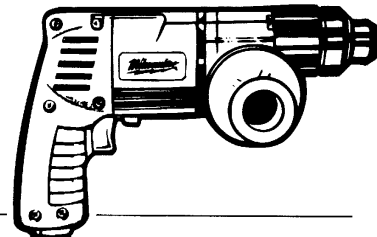

Magnum® Heavy Duty 1/2" Hole Shooter

These powerful 5.2 amp hole shooters have a keyless power chuck and feature trigger speed control reversing. The Model 0235-1 has a speed of 0-850 rpm. The Model 0244-1 has a speed of 0-600 rpm. Both have a double gear train and all ball and roller bearings. Change brushes in less than one minute with the exclusive brush cartridge system. Comes with an 8' Quik-Lok Cord for tangle-free carrying and storing.

| Part No. | Maximum Capacity | | Weight Lbs. | Shipping Wt. | Fig. No. | Price |
|------------|------------------|---------|-------------|--------------|----------|-------|
| | Capacity | Length | | | | |
| MIL 0235-6 | 1/2" | 10 1/2" | 4 7/8 | 6 lbs. | 43738 | |
| MIL 0244-1 | 1/2" | 10 1/2" | 4 3/4 | 6 lbs. | 26689 | |

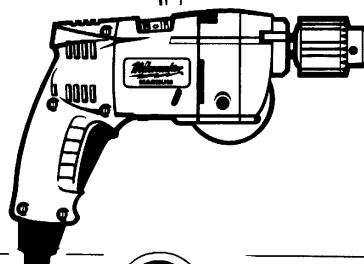

Milwaukee Close Quarters Drill

This drill gets into tight spots where conventional drills can't. It has a 3.5 amp, 120V variable-speed reversing motor that goes from 0-1300 RPM. 55° Angled Chuck for easy access to tight places. Comes with chuck key and rubber flex key holder.

| Part No. | Maximum Capacity | | Weight Lbs. | Shipping Wt. | Fig. No. | Price |
|------------|------------------|--------|-------------|--------------|----------|-------|
| | Capacity | Length | | | | |
| MIL 0375-6 | 3/8" | 10" | 3 1/2 | 6 lbs. | 26691 | |

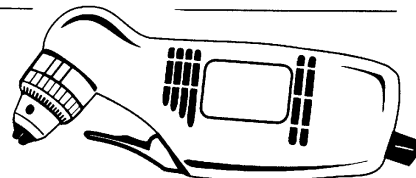

3/8" Variable 2 Speed Cordless 12 Volt Driver Drills

Our 12 V (DC) reversing driver/drills feature a keyless chuck and a smooth, efficient planetary gear system that produces up to 175 In./Lbs. torque. Balanced, comfortable design with a 6 position adjustable clutch. Overload capacity eliminates need for work stopping circuit breaker. Comes with two battery packs, a charger and a steel carrying case.

| Part No. | Speed (RPM) | | Length | Tool Weight | Shipping Weight | Fig. No. | Price |
|------------|-------------|--------|--------|-------------|-----------------|----------|-------|
| | Low | High | | | | | |
| MIL 0407-6 | 0-350 | 0-1000 | 9" | 3 3/4 lbs. | 14 3/4 lbs. | 49399 | |

CORDLESS!

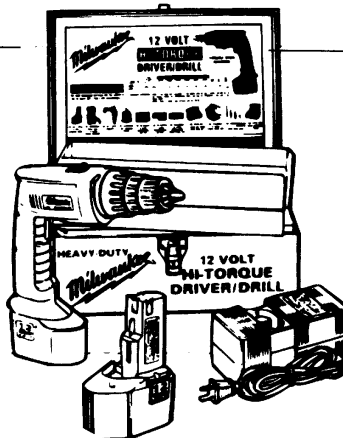

MILWAUKEE TOOLS ARE MADE FOR PROFESSIONALS!

MILWAUKEE TOOLS

Milwaukee Spade Handle Drill

This ruggedly built 450 RPM drill has reserve power for the toughest drilling jobs. Gears are helical-cut for quiet performance, heat treated chrome moly alloy steel for high torque transmission with minimum wear.

| Part No. | Length) | Tool Weight | Shipping Wt. | Fig. No. | Price |
|------------|---------|-------------|--------------|----------|-------|
| MIL 1660-6 | 12 1/4" | 9 1/2 lbs. | 13 lbs. | 20934 | |

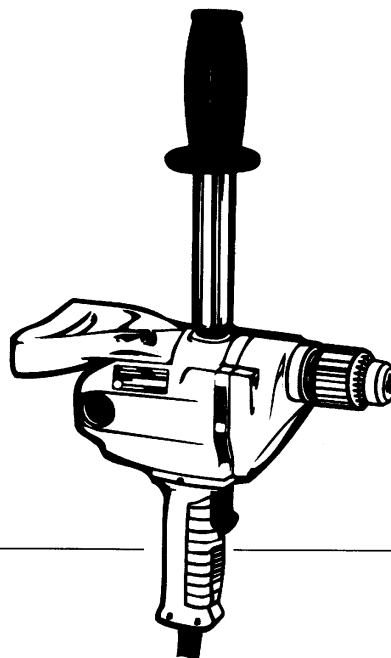

Heavy Duty Hole Hawg® Reversible 2-Speed Drill

Lightweight, compact design for drilling between studs and joists. 7.5 amp, 120V (AC only) motor. Can power up to a 4 5/8" Selffeed bit in low speed (300 rpm). Can drill with up to a 1 3/8" Selffeed bit in high speed (1200 rpm).

| Part No. | Length) | Tool Weight | Shipping Wt. | Fig. No. | Price |
|------------|--|-------------|--------------|----------|-------|
| MIL 1675-6 | 6 1/2" | 10 1/2 lbs. | 16 lbs. | 26707 | |
| MIL 1676-6 | Same as 1675-6, but with steel carrying case | | | 16781 | |

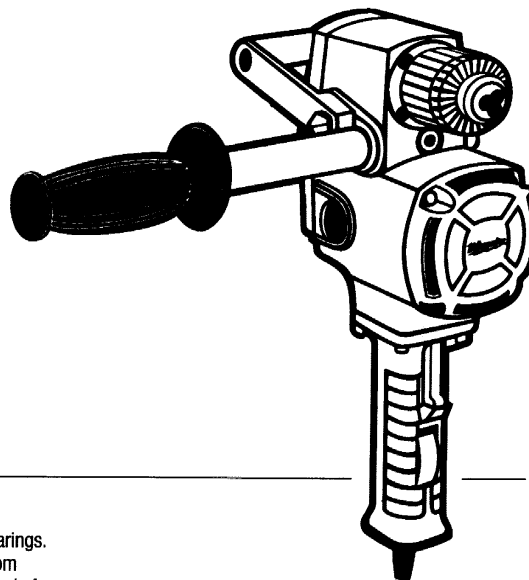

Heavy Duty "D" Handle Reversible Hole-Shooters

Both of these drills have helical cut, heat-treated gears and all ball and roller bearings. The model 1007-1 has a 7.0 amps, 120V (AC only) motor, with speed control from 0-600 rpm. The model 1250-1 has a 7.0 amp, 120V (AC only) motor, with a speed of 950 rpm. Both models have a double gear train and 1/2" steel capacity.

| Part No. | Length) | Tool Weight | Shipping Wt. | Fig. No. | Price |
|------------|---------|-------------|--------------|----------|-------|
| MIL 1007-1 | 14 1/4" | 6 1/2 lbs. | 10 lbs. | 26695 | |
| MIL 1250-1 | 14 1/8" | 6 1/2 lbs. | 10 lbs. | 26699 | |

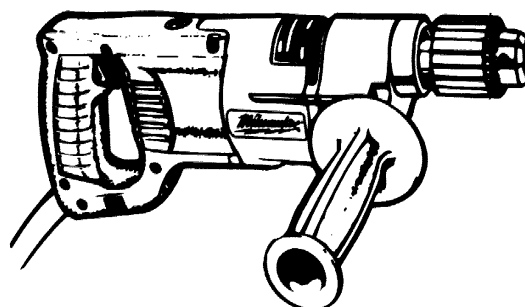

MILWAUKEE TOOLS

1 1/2" THUNDERBOLT SPLINE DRIVE HAMMERS

Vibration Isolation System - reduces operator fatigue and increases comfort and control. Handle "floats" to absorb hammering action. Trigger Controlled Variable Speed, Pre-Set Clutch Protects Mechanism from Overload, Soft Shift Stop Rotation available, Powerful 8.5 Amp Milwaukee Built Motor, Spline Drive Bit System - Efficient transmission of torque to the bit, drives chisels without adapter - 6" core bit capacity. Simple, Positive Sliding bit Lock System - Single handed removal of bits. Ergonomically designed Cushioned Gripping surface for Operator Comfort, Synthetic Grease for Longer Life Between Service Intervals - Adaptable to hot and cold environment, no cold start problems. Rear Side Handle Capability - For enhanced Operator Comfort.

| Part No. | Maximum Capacity | Length | Weight Lbs. | Shipping Wt. | Fig. No. | Price |
|----------|------------------|---------|-------------|--------------|----------|-------|
| MIL 5316 | 1 1/2" | 18 1/2" | 17.5 lbs. | 28 lbs. | 57730 | |

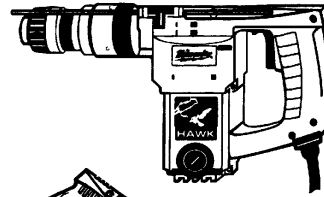

Heavy Duty MAGNUM® 1/2" Hammer Drill Kit

This trigger speed control model has a 1/2" chuck capacity, two-speed reversible gear shift and quik-lok cord set. For percussion carbide-bit drilling in concrete and masonry and drilling without hammering in wood or metal. 5.2 amp, 120v (AC only). Two-speeds: 0-1000 rpm on low (up to 20,000 blows per min.); 0-3600 rpm on high (up to 72,000 blows per min.). Exclusive features include removable brush cartridge system, self-stopping brushes, all ball and roller bearings. Kit includes hammer drill, 8' quik-lok cord, depth gauge, adjustable side handle, chuck key with holder, steel carrying case and bits.

| Part No. | Spindle Thread | Length | Weight Lbs. | Shipping Wt. | Fig. No. | Price |
|------------|----------------|--------|-------------|--------------|----------|-------|
| MIL 5371-6 | 1/2" - 20 | 13" | 5 3/4 | 15 1/4 lbs. | 16826 | |

| Speed | Bit Capacity | | | | | | | | |
|-------|---|-------|------------|-----------|----------|-------------|-------------|--------------|--|
| | Wood | | | | Steel | | Concrete | | |
| | Flat Bore | Auger | Ship Auger | Self-feed | Hole Saw | Twist Drill | Carbide Tip | Screw Fast'r | |
| Low | 1 1/2" | 7/8" | 7/8" | 1 1/8" | 3 1/4" | 1/2" | 5/8" | 1/4" | |
| High | SET GEAR SHIFT TO LOW WHEN BORING HOLES IN WOOD | | | | | | | 3/8" | |

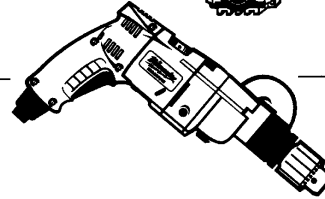

Hammer Drill

This trigger speed control model has similar features to the 5371 (above). Drill speed of 0-2,500 rpm, up to 50,000 blows per minute. Kit includes hammer drill, 8' quik-lok cord, depth gauge, adjustable side handle, chuck key with holder, steel carrying case and bits.

| Part No. | Description | Spindle Thread | Length | Wt. Lbs. | Shipping Wt. | Fig. No. | Price |
|------------|------------------|----------------|---------|----------|--------------|----------|-------|
| MIL 5374-1 | Hammer Drill | 1/2" - 20 | 11 1/2" | 5 1/4 | 6 1/2 lbs. | 26818 | |
| MIL 5375-1 | Hammer Drill Kit | 1/2" - 20 | 11 1/2" | 5 1/4 | 14 1/2 lbs. | 16850 | |

| Speed | Bit Capacity | | |
|-------|--------------|-------------|-------------|
| | Wood | Steel | Concrete |
| | Flat Bore | Twist Drill | Carbide Tip |
| Low | 3/4" | 3/8" | 9/16" |

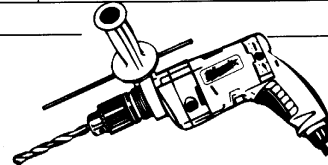

Heavy Duty 1/2" Hammer Drill Kit

For percussion carbide-bit drilling in concrete and masonry and drilling without hammering in wood or metal. 6.2 amp, 120v (AC only). Two-way action: hammering with rotation or rotation only. Up to 950 rpm, variable speed (up to 19,000 blows per min.) Features include adjustable side handle for maximum control, adjustable depth rod, all ball and roller bearings, turn collar for selection: hammer-drill or drill only. Kit includes hammer drill, depth rod, side handle, chuck key, and steel carrying case.

| Part No. | Description | Length | Weight Lbs. | Shipping Wt. | Fig. No. | Price |
|----------|------------------|---------|-------------|--------------|----------|-------|
| MIL 5399 | Hammer Drill Kit | 15 1/2" | 7 1/2 | 18 lbs. | 26826 | |

| Speed | Bit Capacity | | | | | | | | | | | |
|-------|--------------|-------|------------|--------|--------|--------|---------|--------|------|-------------|------------------|------------------|
| | Drill only | | | | Hammer | | | | | | | |
| | Wood | | Self-feed | | Steel | | Masonry | | | | | |
| Low | Flat Bore | Auger | Ship Auger | 1 1/2" | 1" | 1 1/8" | 1 1/2" | 3 1/2" | 1/2" | Twist Drill | Carbide Tip Soft | Carbide Tip Hard |
| High | 1 1/2" | 1" | 1 1/8" | 1 1/2" | 3 1/2" | 1/2" | 7/8" | 5/8" | | | | |

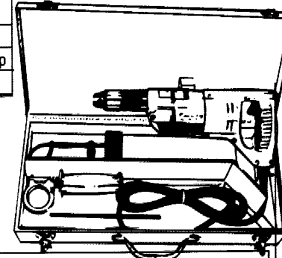

Heavy Duty Reversing Right Angle Drill Kits

Our Electrician's Kit features a Model 1001-1 heavy duty "D" handle Hole Shooter with a 7.0 amp 120V variable-speed motor. It has a 1/2" steel capacity and a speed of 600 rpm. Our Plumber's Kit features a Model 1201-1 heavy duty "D" handle Hole Shooter with a 4.5 amp 120V (AC only) single-speed motor. It has a 1/2" steel capacity and a speed of 500 rpm. Our Magnum® RAD Kit features a Model 0234-1 heavy duty Hole Shooter with a 5.3 amp 120V (AC only) trigger speed control motor. It has a 1/2" steel capacity and a speed of 0-850 rpm, and comes with an 8' Quik-Lok cord set. Both kits come with right angle drive, open end wrench, socket wrench, chuck remover bar, side handle and steel carrying case.

| Part No. | Description | RPM w/RAD | | Gear Train | Shipping Wt.(lbs.) | Fig. No. | Price |
|------------|-------------------|-----------|--------|------------|--------------------|----------|-------|
| | | Low | High | | | | |
| MIL 3002-1 | Electrician's Kit | 0-400 | 0-900 | Triple | 21 | 45292 | |
| MIL 3107-8 | Plumber's Kit | 0-335 | 0-750 | Triple | 21 | 26716 | |
| MIL 3300-1 | Magnum® Kit | 0-565 | 0-1275 | Double | 14 | 26718 | |

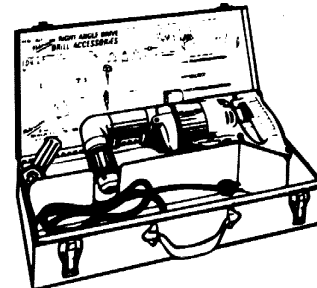

BITS AVAILABLE FOR:

MILWAUKEE, BOSCH, HILTI,
BLACK & DECKER, SKILL

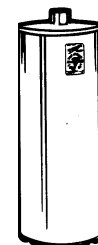
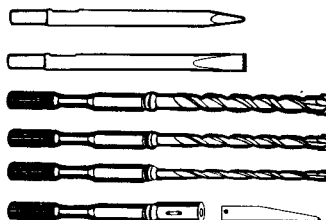

CHISELS,
SPLINE BITS
AND CORE BITS
READILY
AVAILABLE

MILWAUKEE DRILL ACCESSORIES

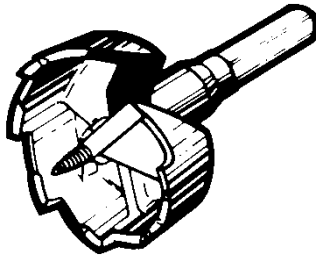

Self-feed bits. All sizes have removable and replaceable feed screws. Two feed screws furnished with each bit. Regular and coarse screws permit selecting the right feed for the material you're drilling. Coarse feed screw provides fast effortless feeding even in gummy woods. Inside cutting plane shaves hole radius for clean smooth holes without pressure. All with 7/16 Hex type shank.

| OEM # | DIA | FOR DRILL MODELS | FOR STD PIPE SIZES | FIG. NO. | PRICE |
|------------|---------|---|--------------------|----------|-------|
| 48-25-1121 | 1 1/8" | 1/2" pistol | 3/4" | 16662 | |
| 48-25-1251 | 1 1/4" | grip and larger drills | | 16672 | |
| 48-25-1371 | 1 3/8" | | | 16676 | |
| 48-25-1501 | 1 1/2" | 1/2" D-Handle drills and larger drills | 1" | 16680 | |
| 48-25-1751 | 1 3/4" | | | 16684 | |
| 48-25-2001 | 2" | | 1 1/2" | 16689 | |
| 48-25-2121 | 2 1/8" | | | 16693 | |
| 48-25-2251 | 2 1/4" | | | 16699 | |
| 48-25-2561 | 2 9/16" | 1/2" D-handle drills and larger drills except 1001-1 and 1007-1 | 2" | 16705 | |

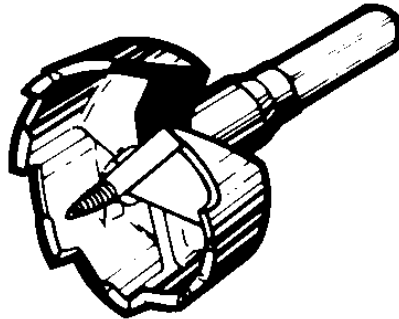

Large Self-feed bits. 3", 3-5/8" AND 4-5/*" sizes have double inside cutter blades that shave hole radius for clean smooth holes without pressure. Two feed screws furnished with each bit. All with 3 milled flat type shank.

| OEM # | DIA | FOR DRILL MODELS | FOR STD PIPE SIZES | FIG. NO. | PRICE |
|------------|--------|------------------|--------------------|----------|-------|
| 48-25-3001 | 3" | 1675-1, | 2 1/2" | 16710 | |
| 48-25-3621 | 3-5/8" | 1700-1 AND | 3" | 16715 | |
| 48-25-4621 | 4-5/8" | LARGER | 4" | 16720 | |

4 Bit Contractors' Kit. Assortment of Milwaukee selffeed bits for BIG HOLE drilling. Sizes include 1 3/8", 1 1/2", 2 1/8" 2 9/16" diameters. Also 5 1/2" one piece shank and coupling extension, two extra feed screw pilots for each bit (one coarse and one regular), three socket wrenches and carrying case.

| OEM # | FIG. NO. | PRICE |
|------------|----------|-------|
| 49-22-0135 | 48531 | |

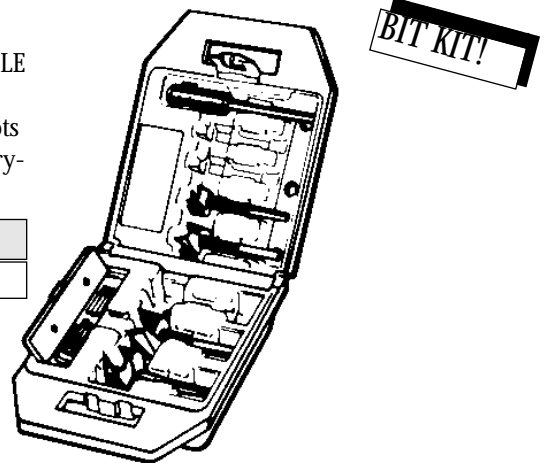

7/8" HEX SHANK EXTENSION

One piece 7/16" for hole saws. Selffeed bits and auger bits (1" dia. and larger) with 7/16" hex shank.

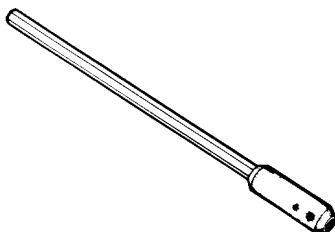

| OEM # | LGTH | FIG. NO. | PRICE |
|------------|--------|----------|-------|
| 48-28-4000 | 5 1/2" | 30713 | |
| 48-28-4005 | 12" | 30691 | |
| 48-28-4010 | 18" | 30692 | |
| 48-28-4015 | 24" | 30693 | |

PILOT DRILL



1/4" High Speed Pilot Drill. For use with Hole Saw Arbors 16616, 16619. For general cutting of wood and metal.

| OEM # | FIG. NO. | PRICE |
|------------|----------|-------|
| 49-56-8000 | 16623 | |

ARBOR ADAPTERS. Arbors and hole saws are interchangeable with most other brands.



1/4" Shank with 3 flats. Three milled flats prevent slipping in chuck. For small hole saws in medium weight materials and wood.

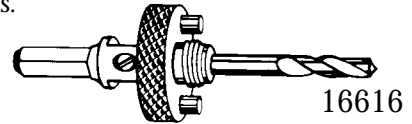

Quick change 7/16" hex shank.

| OEM # | FIG. NO. | THREAD SIZE | PILOT DRILL SIZE | FOR HOLE SAW SIZES | PRICE |
|------------|----------|-------------|------------------|---------------------|--------|
| 49-56-6960 | 16609 | 1/2" -20 | 1/4" | 9/16 - 1 | larger |
| 49-56-7055 | 16616 | 5/8" -18 | 1/4" | 13/16 1 1/4" and | |

HOLE SAW KITS

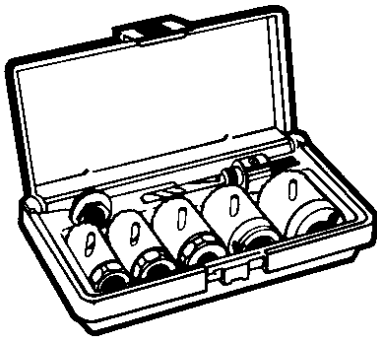

7 Piece 4/6 tooth job saver kit - Consists of 7/8", 1" 1-1/8", 1-1/4", 1 1/2" sizes. Includes Arbor, Arbor spacer, Arbor Adapter and sturdy plastic case.

| OEM # | FIG. NO. | PRICE |
|------------|----------|-------|
| 49-22-4071 | 47098 | |



13 Piece 4/6 tooth plumbers and electrician's kit - Consists of 3/4", 7/8" 1-1/8", 1-3/8", 1-1/2", 1-3/4", 2", 2-1/4", 2-1/2" sizes. Includes 2 arbors, Pilot drill, Arbor spacer, Arbor Adapter and sturdy plastic case.

| OEM # | FIG. NO. | PRICE |
|------------|----------|-------|
| 49-22-4065 | 30836 | |

JIG SAW BLADE ASSORTMENT

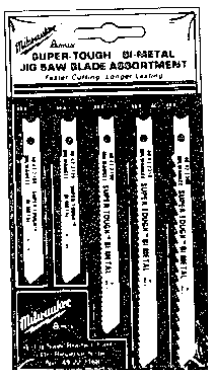

Super-tough bi-metal jig saw blade vinyl pack assortment.

| OEM # | FIG. NO. | PRICE |
|------------|----------|-------|
| 49-22-1168 | 30821 | |

BLADE CLAMP SCREW ONLY

With captive lock washer.



| OEM # | FIG. NO. | PRICE |
|------------|----------|-------|
| 06-75-2402 | 18126 | |

MILWAUKEE SUPER-TOUGH BI-METAL HOLE SAWS

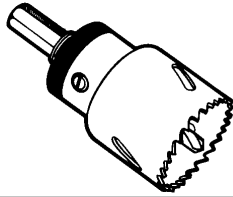

Bi-metal construction. Heavy duty 3/16" thick steel back. 1 1/4" cutting depth for sizes 9/16" - 1 7/16". 1 1/2" cutting depth for sized 1 1/2" - 6". Faster, aggressive cutting. Less vibration for smoother cuts. Shatter resistant. High alloy steel body construction for longer life. 4/6 teeth - a multiple tooth design with varying tooth sets and gullet depths. Deeper gullets provide more efficient chip clearance with less heat build-up. Requires lower feed pressure - ideal for the higher RPM of portable drills.

| OEM # | HOLE DIA | HOLE DIA | DEPTH OF CUT | USE WITH ARBOR | PIPE TAP | PIPE ENTRANCE SIZE | COPPER PIPE SIZE ID | FIG. NO. | PRICE |
|------------|----------|----------|--------------|----------------|----------|--------------------|---------------------|----------|-------|
| 49-56-0006 | 9/16" | 14MM | 1 1/4" | 16609 | | | 1/8" | 16479 | |
| 49-56-0011 | 5/8" | 16MM | | 16609 | | | 1/4" | 16480 | |
| 49-56-0016 | 11/16" | 17MM | | 16609 | | | 3/8" | 16484 | |
| 49-56-0021 | 3/4" | 19 MM | | 16609 | | 3/8" | 1/2" | 16486 | |
| 49-56-0026 | 13/16" | 21 MM | | 16609 | | | 1/2" | 16487 | |
| 49-56-0031 | 7/8" | 22 MM | | 16609 | 3/4" | 1/2" | 5/8" | 16492 | |
| 49-56-0036 | 15/16" | 24 MM | | 16609 | | | | 16495 | |
| 49-56-0041 | 1" | 25 MM | | 16609 | | | 3/4" | 16497 | |
| 49-56-0046 | 1 1/16" | 27 MM | | 16609 | | | | 16499 | |
| 49-56-0051 | 1 1/8" | 29 MM | | 16609 | 1" | 3/4" | 3/4" | 16505 | |
| 49-56-0056 | 1 3/16" | 30 MM | | 16609 | | | | 16508 | |
| 49-56-0061 | 1 1/4" | 32 MM | | 16616 | | | 1" | 16510 | |
| 49-56-0066 | 1 5/16" | 33 MM | | 16616 | | | | 44143 | |
| 49-56-0071 | 1 3/8" | 35 MM | | 16616 | | 1" | | 16516 | |
| 49-56-0076 | 1 7/16" | 37 MM | | 16616 | | | | 16518 | |
| 49-56-0081 | 1 1/2" | 38 MM | | 16616 | 1 1/4" | | 1 1/4" | 16521 | |
| 49-56-0086 | 1 9/16" | 40 MM | | 16616 | | | | 16524 | |
| 49-56-0091 | 1 5/8" | 41 MM | | 16616 | | | | 16527 | |
| 49-56-0096 | 1 11/16" | 43 MM | | 16616 | | | | 16529 | |
| 49-56-0101 | 1 3/4" | 44 MM | | 16616 | 1 1/2" | 1 1/4" | 1 1/2" | 16535 | |
| 49-56-0106 | 1 13/16" | 46 MM | | 16616 | | | | 16538 | |
| 49-56-0111 | 1 7/8" | 48 MM | | 16616 | | | | 16542 | |
| 49-56-0116 | 2" | 51 MM | | 16616 | | 1 1/2" | | 16545 | |
| 49-56-0121 | 2 1/16" | 52 MM | | 16616 | | | | 16547 | |
| 49-56-0126 | 2 1/8" | 54 MM | | 16616 | | | | 16549 | |
| 49-56-0131 | 2 1/4" | 57 MM | | 16616 | 2" | | 2" | 16552 | |
| 49-56-0136 | 2 5/16" | 59 MM | | 16616 | | | | 16556 | |
| 49-56-0141 | 2 3/8" | 60 MM | | 16616 | | | | 16559 | |
| 49-56-0146 | 2 1/2" | 64 MM | 1 1/2" | 16616 | | 2" | 2" | 16562 | |
| 49-56-0150 | 2 9/16" | 65 MM | | 16616 | | | | 16576 | |
| 49-56-0155 | 2 5/8 | 67 MM | | 16616 | 2 1/2" | | | 16579 | |
| 49-56-0160 | 2 3/4" | 70 MM | | 16616 | | | | 16580 | |
| 49-56-0165 | 2 7/8" | 73 MM | | 16616 | | | | 16585 | |
| 49-56-0170 | 3" | 76 MM | | 16616 | | 2 1/2" | 2 1/2" | 16587 | |
| 49-56-0175 | 3 1/8" | 79 MM | | 16616 | | | | 16589 | |
| 49-56-0180 | 3 1/4" | 83 MM | | 16616 | 3" | | | 16591 | |
| 49-56-0185 | 3 3/8" | 86 MM | | 16616 | | | | 16593 | |
| 49-56-0190 | 3 1/2" | 89 MM | | 16616 | | | | 16595 | |
| 49-56-0195 | 3 5/8" | 92 MM | | 16616 | | 3" | | 16597 | |
| 49-56-0200 | 3 3/4" | 95 MM | | 16616 | 3 1/2" | | | 16599 | |
| 49-56-0205 | 3 7/8" | 98 MM | | 16616 | | | 3 1/2" | 16600 | |
| 49-56-0210 | 4" | 102 MM | | 16616 | | | | 16601 | |
| 49-56-0215 | 4 1/8" | 105 MM | | 16616 | | 3 1/2" | 3 1/2" | 16603 | |
| 49-56-0220 | 4 1/4" | 108 MM | | 16616 | 4" | 3 1/2" | 4" | 16605 | |
| 49-56-0225 | 4 3/8" | 111 MM | | 16616 | | | | 43739 | |
| 49-56-0230 | 4 1/2" | 114 MM | | 16616 | | 4" | 4" | 19628 | |
| 49-56-0235 | 4 3/4" | 121 MM | | 16616 | | | | 44281 | |
| 49-56-0240 | 5" | 127 MM | | 16616 | | | | 43268 | |
| 49-56-0245 | 5 1/2" | 140 MM | | 16616 | | | 5" | 43361 | |
| 49-56-0250 | 6" | 152 MM | | 16616 | | | | 44282 | |

MILWAUKEE BORING AND DRILL BITS

FLAT BORING BITS AND EXTENSIONS

Flat boring bits are precision made of high carbon steel for durability and long life. Bore clean holes fast at any angle in wood, plastic, plywood and formica. Drill point and cutting edge can be resharpened often.

- * Flute Bit Clears Chips * Bores Cleaner and Faster *
- Furnished with Hole for use in Wire Pulling * Fits for Secure Chuck Grip

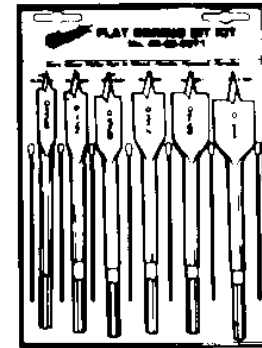
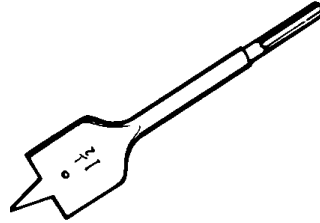

Premium Quality - Heat Treated for Strength and Hardness

| DIA | OEM # | SHANK DIA | OVERALL DIA | FIG. NO. | PRICE |
|--------|------------|-----------|-------------|----------|-------|
| 1/4" | 48-27-0251 | 3/16" | 6 3/16" | 30532 | |
| 5/16" | 48-27-0311 | 3/16" | 6 3/16" | 30533 | |
| 3/8" | 48-27-0371 | 1/4" | 6 1/16" | 30534 | |
| 7/16" | 48-27-0441 | 1/4" | 6 1/16" | 30535 | |
| 1/2" | 48-27-0501 | 1/4" | 6 1/8" | 30536 | |
| 9/16" | 48-27-0561 | 1/4" | 6 1/8" | 30541 | |
| 5/8" | 48-27-0621 | 1/4" | 6 1/8" | 30542 | |
| 11/16" | 48-27-0681 | 1/4" | 6 1/8" | 30543 | |
| 3/4" | 48-27-0751 | 1/4" | 6 3/8" | 30544 | |
| 13/16" | 48-27-0811 | 1/4" | 6 1/8" | 30545 | |
| 7/8" | 48-27-0871 | 1/4" | 6 1/8" | 28930 | |
| 15/16" | 48-27-0941 | 1/4" | 6 3/16" | 30547 | |
| 1" | 48-27-1001 | 1/4" | 6 3/16" | 29160 | |
| 1 1/8" | 48-27-1121 | 1/4" | 6 3/8" | 30548 | |
| 1 1/4" | 48-27-1251 | 1/4" | 6 3/8" | 30549 | |
| 1 3/8" | 48-27-1371 | 1/4" | 6 3/8" | 30550 | |
| 1 1/2" | 48-27-1501 | 1/4" | 6 3/8" | 30551 | |

Flat boring bit Kit - Contains 6 popular size flat boring bits in heavy protective plastic. Assortment includes 3/8", 1/2", 5/8", 3/4", 7/8" and 1" sizes in pockets for orderly storage, easy size selection.

| OEM # | FIG. NO. | PRICE |
|------------|----------|-------|
| 49-22-0071 | 37707 | |

FAX YOUR ORDER!

610-279-6299

OR CALL US AT 610-275-4453

HIGH SPEED STEP DRILL BITS

Drill perfectly round holes in steel, brass, copper, aluminum, wood, plexiglass and plastic.

Self-starting multi-hole bit. 1/4" shank, 13 hole sizes, make this the perfect all-around bit for most common drilling jobs.



| OEM # | FIG. NO. | PRICE |
|------------|----------|-------|
| 48-89-9100 | 43363 | |

Self-starting multi-hole bit - 3/8" shank, 9 hole sizes makes this a good choice for medium size holes.



| OEM # | FIG. NO. | PRICE |
|------------|----------|-------|
| 48-89-9105 | 43364 | |

Hole Enlarging Bit - 3/8" shank, 9 hole size, makes this the companion to #43363. Requires 1/2" or larger pilot hole.



| OEM # | FIG. NO. | PRICE |
|------------|----------|-------|
| 48-89-9110 | 43365 | |

MILWAUKEE TOOLS

Milwaukee Heavy Duty Sawzall®

Cut any sawable material with our powerful 4 amp Sawzall®. Two speeds— 2400 or 1700 strokes per minute. Plunge cuts directly into floors, walls and other surfaces composed of resilient materials. No starting hole required! Comes in a steel carrying case with 7 extra blades for wood and metal. Also includes hex key and holder, extra blade clamp and screw.

| Part No. | Length of Stroke | Tool Length | Weight Lbs. | Shipping Wt. (lbs.) | Fig. No. | Price |
|------------|------------------|-------------|-------------|---------------------|----------|-------|
| MIL 6511-6 | 3/4" | 16" | 7 | 18 | 16820 | |

Reciprocating Saw Blades found on pages 73, 66.

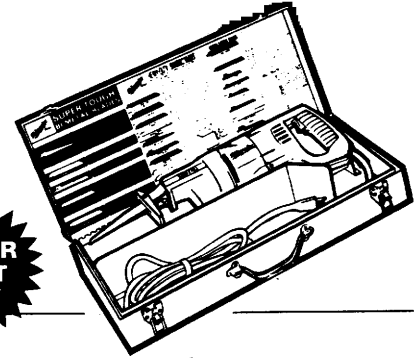

Milwaukee Sawzall®

This Sawzall® is dual range and variable speed: from 0-2400 or 0-1700 strokes per minute. Plunge cuts directly into floors, walls and other surfaces composed of resilient materials. No starting hole required! Comes in a steel carrying case with 7 extra blades for wood and metal, plus a hex key and holder, extra blade clamp and screw.

| Part No. | Length of Stroke | Tool Length | Weight Lbs. | Shipping Wt. (lbs.) | Fig. No. | Price |
|------------|------------------|-------------|-------------|---------------------|----------|-------|
| MIL 6507-6 | 3/4" | 16" | 7 | 18 | 26983 | |

Reciprocating Saw Blades found on pages 73, 66.

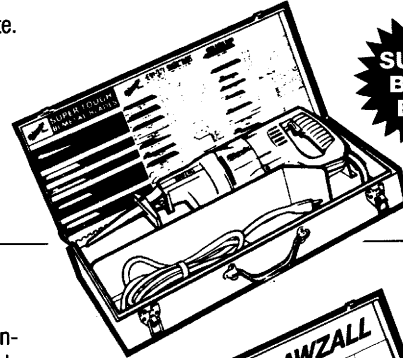

High Performance, Dual Range, Variable Speed Super SAWZALL®

These powerful 8 amp Super SAWZALL® saws are the smoothest operating, most vibration-free saws in the world. They feature all ball and roller bearings, and an improved heavy-duty blade clamp system that allows close quarter flush cuts. 1 1/4" blade travel for extremely fast cuts. Blade can be reversed for cutting in confined areas. Adjustable shoe release lever easily adjusts shoe without the use of tools. Model 6527 has an 8' Quik-Lok cord and the Model 6528 has an 8' rubber cord. Both come with a blade assortment, two hex keys, a hex key holder, a blade clamp screw, and a steel carrying case.

| Part No. | Strokes per minute | | Tool Length | Tool Weight | Shipping Weight | Fig. No. | Price |
|------------|--------------------|--------|-------------|-------------|-----------------|----------|-------|
| | Low | High | | | | | |
| MIL 6527-6 | 0-2000 | 0-2800 | 17 1/2" | 8 3/4 lbs. | 19 3/4 lbs. | 45323 | |
| MIL 6528-6 | 0-2000 | 0-2800 | 17 1/2" | 8 3/4 lbs. | 19 3/4 lbs. | 45324 | |

Reciprocating Saw Blades found on pages 73, 66.

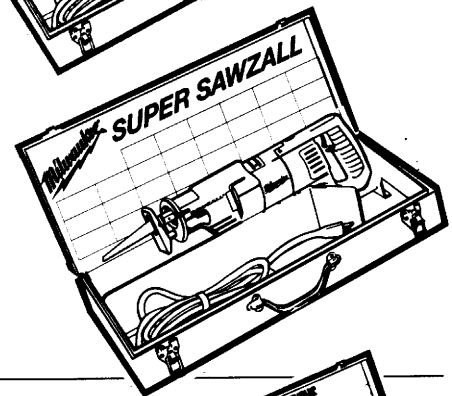

Milwaukee Heavy Duty Variable Speed Sawzall

Similar to the 6508, the 6509-6 has a one-speed range (0-2400) and comes with a nylon motor housing. The 6509-6 does not have the Quik-Lok® cord feature. Comes with a 2-blade pack and a steel carrying case.

| Part No. | Length of Stroke | Tool Length | Weight Lbs. | Shipping Wt. (lbs.) | Fig. No. | Price |
|------------|------------------|-------------|-------------|---------------------|----------|-------|
| MIL 6509-6 | 3/4" | 16" | 6.75 | 16.5 | 57751 | |

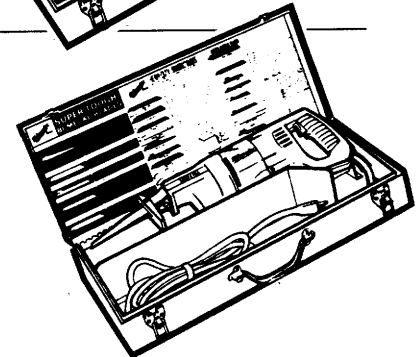

Battery packs and chargers also available from DUFF

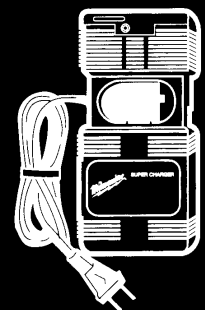
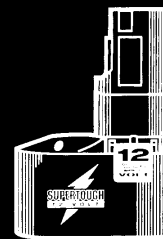

MILWAUKEE TOOLS
SAWZALL AND BLADES

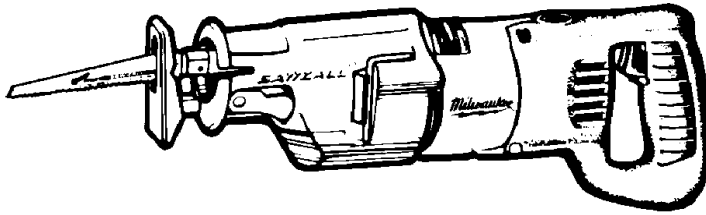

ALL MILWAUKEE TOOLS AND PARTS ARE AVAILABLE THRU DUFF CO. WE SHOW ONLY THE MOST POPULAR. ASK FOR A FULL MILWAUKEE CATALOG!

HEAVY-DUTY SUPER SAWZALL

- * Fast, smooth, high performance
- * Patented counter-balance mechanism reduces vibration for extra smooth operation
- * Long 1-1/4" blade stroke
- * Patented shoe release lever easily adjusts shoe without tools
- * Dual range variable speed - 0-2000 spm and 0-2800 spm
- * 8' Quik-Lok cord for easy field replacement
- * Includes 7 high performance Super Sawzall blades, hex key, extra blade clamp/screw and steel carrying case
- * Patented rubber boot is designed for operator comfort
- * Reversible blade for cutting upside down

| OEM # | FIG. NO. | PRICE |
|-------|----------|-------|
| 6527 | 45323 | |

HEAVY DUTY 18 VOLT POWER-PLUS SAWZALL

- * Cordless convenience now in a sawzall
- * Quick-lok blade clamp for a fast and easy blade change
- * Trigger speed control 0-2,000 spm.
- * Rare earth permanent magnet motor for high torque
- * Heavy-duty steel wobble plate mechanism for reliability and long life
- * Reverse the blade for cutting upside down in confined areas
- * Pivot shoe for maximum support against work surface
- * 84902 includes all of the above, plus an extra battery

| OEM # | FIG. NO. | PRICE |
|---------|----------|-------|
| 6516-22 | 84902 | |

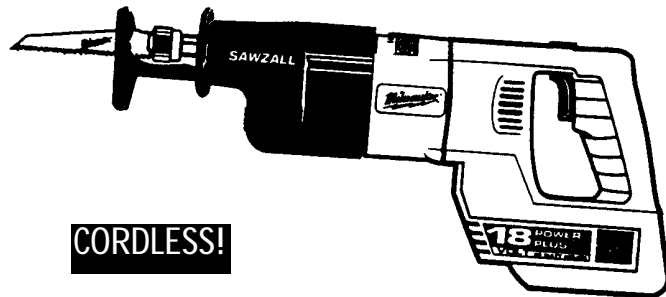

CORDLESS!

SUPER SAWZALL BLADES

All Milwaukee Sawzall Blades are packaged and sold five blades to a pack. Heat treated for maximum cutting speed and abrasion resistance. Sharp, fast cutting, long lasting, 1/2" universal tang.



PLASTER CUTTING BLADES - 5 PACK For cutting plaster with metal lath

| OEM # | TEETH PER INCH | LENGTH | FIG. NO. | PRICE PER PACK |
|------------|----------------|--------|----------|----------------|
| 48-01-1052 | 6 | 6" | 50818 | |

Long-life-cutting plaster, plaster with metal lath, plasterboard. Cuts on both forward and backward stroke.



TUNGSTEN CARBIDE BLADES - 5 PACK For cutting wood, metals, fiberglass, ceramic materials.

| OEM # | TEETH PER INCH | LENGTH | FIG. NO. | PRICE PER PACK |
|------------|----------------|--------|----------|----------------|
| 48-01-1420 | Course Grit | 6" | 50821 | |

Medium and coarse grits for cutting plywood, hardwood flooring, cast iron, stainless steel, fiberglass materials (polyester, epoxies, melamines), ceramic tile, stone, slate, clay pipe, carbon, brick, plaster, marble, chalkboard.

MILWAUKEE TOOLS

SUPER SAWZALL BLADES, (CONT'D)



WOOD CUTTING BLADES - 5 PACK. For cutting wood, nail embedded wood, all purpose, general roughing-in.

| OEM # | TEETH PER INCH | LENGTH | FIG. NO. | PRICE | |
|------------|----------------|--------|----------|-------|---|
| 48-01-3031 | 5/8 | 6" | 36437 | | Very fast cutting, nail embedded wood, general roughing-in. |
| 48-01-3035 | 6 | 6" | 36438 | | |
| 48-01-3036 | 6 | 9" | 36439 | | |
| 48-01-3037 | 6 | 12" | 36440 | | |
| 48-01-3041 | 4/6 | 6" | 36441 | | |



WOOD CUTTING BLADES - 5 PACK. For cutting wood, nail embedded wood, composition materials.

| OEM # | TEETH PER INCH | LENGTH | FIG. NO. | PRICE | |
|------------|----------------|--------|----------|-------|---|
| 48-01-1011 | 4" | 4" | 36426 | | Fast cutting, all woods, nail embedded, composition material. |
| 48-01-1012 | 6" | 6" | 36427 | | |



METAL CUTTING BLADES - 5 PACK. For cutting metal, scroll cutting.

| OEM # | TEETH PER INCH | LENGTH | FIG. NO. | PRICE | |
|------------|----------------|--------|----------|-------|---|
| 48-01-1161 | 10 | 3-5/8" | 36428 | | Scroll cutting wood, contours, nail embedded wood, plastic, non-ferrous metals. |
| 48-01-1162 | 14 | 3-5/8" | 36429 | | Scroll cutting metal 3/16" thru 1/4" |
| 48-01-1163 | 18 | 3-5/8" | 36430 | | Scroll cutting metal 1/8" thru 3/16" |



METAL CUTTING BLADES - 5 PACK. For heavy gauge metal.

| OEM # | TEETH PER INCH | LENGTH | FIG. NO. | PRICE | |
|------------|----------------|--------|----------|-------|---|
| 48-01-1181 | 14 | 4" | 36431 | | Metal 3/16" thru 1/3", conduit, tubing, channels, pipe, rubber, fiber |
| 48-01-1182 | 14 | 6" | 36432 | | |
| 48-01-1183 | 18 | 4" | 36433 | | Metal 1/8" thru 3/16" conduit, tubing, channels, pipe. |
| 48-01-1184 | 18 | 6" | 36434 | | |
| 48-01-1185 | 24 | 4" | 36435 | | Metal thinner than 1/8", tubing, pipe, trim. |
| 48-01-1186 | 24 | 6" | 36436 | | |



ALL PURPOSE BLADES - 5 PACK. For cutting wood, nail embedded wood, plastics, metal, cast iron.

| OEM # | TEETH PER INCH | LENGTH | FIG. NO. | PRICE | |
|------------|----------------|--------|----------|-------|---|
| 48-01-3090 | 10 | 4" | 36442 | | All woods, nail embedded, composition material, plastic, non-ferrous metals. |
| 48-01-3092 | 10 | 6" | 36443 | | |
| 48-01-3093 | 10/14 | 8" | 36444 | | All woods, nail embedded, composition material, plastic, non-ferrous metals, cast iron. |
| 48-01-3094 | 10/14 | 12" | 43359 | | |

For additional information call: 610-275-4453 or Fax: 610-279-6299
Please call for current prices.

MILWAUKEE TOOLS

Milwaukee Band Saw

Our heavy duty band saw is perfect for any construction site. Makes deep cuts in a wide range of materials. Uses standard 44⁷/₈" x 1¹/₂" x .020 band saw blades. It has a 6.0 amp, 120V motor and trigger speed control. Cuts 0-350 surface feet per minute. The gear drive mechanism is grease lubricated – no oiling required. Precision ball bearing blade glide. Front T-handle for better control. Comes with steel carrying case.

| Part No. | Capacity | | Tool Weight | Shipping Weight | Fig. No. | Price |
|------------|---------------------------------|---|-------------|-----------------|----------|-------|
| | Round Stock | Rectangular Stock | | | | |
| MIL 6232-6 | 4 ³ / ₄ " | 4 ³ / ₄ " x 4 ³ / ₄ " | 17 lbs. | 20.5 lbs. | 26969 | |

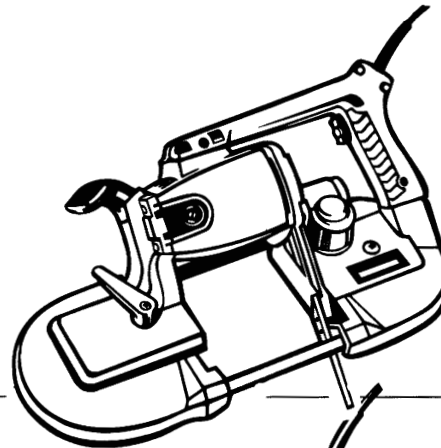

Milwaukee Heavy Duty Band Saw

This saw cuts at two-speeds: 200 or 250 surface feet per minute. It has a 6.5 amp, 120V motor and trigger speed control. The gear drive mechanism is grease lubricated – no oiling required. Precision ball bearing blade glide. Front T-handle for better control. Ideal for sawing PVC tubing. Comes with steel carrying case.

| Part No. | Capacity | | Tool Weight | Shipping Weight | Fig. No. | Price |
|----------|---------------------------------|---|-------------|-----------------|----------|-------|
| | Round Stock | Rectangular Stock | | | | |
| MIL 6226 | 3 ¹ / ₂ " | 4 ¹ / ₂ " x 4 ¹ / ₂ " | 16 lbs. | 18.5 lbs. | 26966 | |

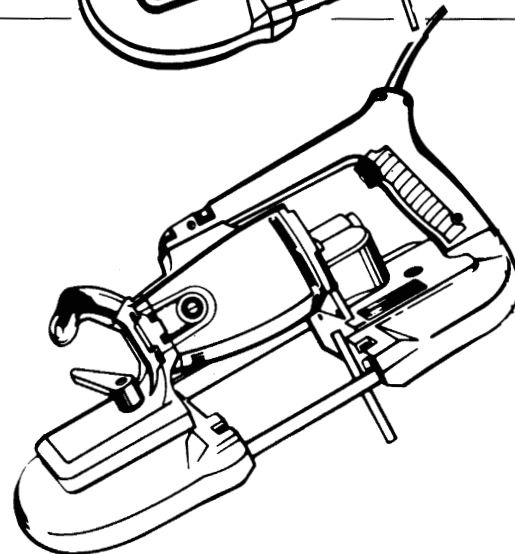

BAND SAW BLADES

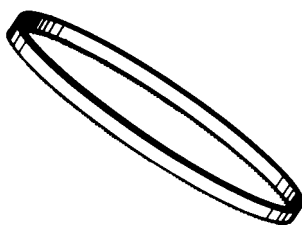

Milwaukee Super-tough Bi-metal blades outlast conventional blades up to 3 times, requiring fewer blade changes. Extremely hard and uniform tooth point is electron beam welded to a tough durable backing with highflex life for faster cutting, longer blade life.

FOR USE WITH MILWAUKEE BAN SAWS USING 44-7/8" X 1/2" X .020 BLADES.

RECOMMENDED FOR; high speed cutting of aluminum, angle iron, bronze, brass, copper, galvanized pipe, mild steel, and tougher steels including stainless, chrome, tungsten steels plus other problem material slow speed.

| OEM # | DIA/WALL THICKNESS | TEETH PER INCH | FIG. NO. | PRICE |
|------------|--------------------|----------------|----------|-------|
| 48-39-0500 | 5/16" & UP | 10 | 36472 | |
| 48-39-0510 | 3/16" - 5/16" | 14 | 66197 | |
| 48-39-0520 | 5/32" - 3/16" | 18 | 38440 | |
| 48-39-0530 | UP TO 5/32" | 24 | 72725 | |

High speed steel blades will outlast carbon steel and alloy steel blades for cutting most materials. Ideal for cutting carbon steel, drill rod and other solid and large diameter hard materials.

FOR USE WITH BAND SAWS USING 53-3/4" X 1/2" X O20 BLADES

RECOMMENDED FOR; high speed cutting of aluminum, angle iron, bronze, brass, copper, galvanized pipe, mild steel, and tougher steels including stainless, chrome, tungsten steels plus other problem material slow speed.

| OEM # | DIA/WALL THICKNESS | TEETH PER INCH | FIG. NO. | PRICE |
|------------|--------------------|----------------|----------|-------|
| 48-39-0450 | 5/16" & UP | 10 | 72726 | |
| 48-39-0460 | 3/16" - 5/16" | 14 | 72727 | |
| 48-39-0470 | 5/32" - 3/16" | 18 | 72728 | |
| 48-39-0480 | UP TO 5/32" | 24 | 44718 | |

MILWAUKEE TOOLS

Milwaukee Heavy Duty Band Saw

This saw cuts at two-speeds: 200 or 250 surface feet per minute. It has a 6.0 amp, 120V motor and trigger speed control. The gear drive mechanism is grease lubricated—no oiling required. Precision ball bearing blade guide. Front T-handle for better control. Ideal for sawing PVC tubing. Comes with steel carrying case. Uses standard 44⁷/₈" x 1¹/₂" x .020 band saw blades.

| Part No. | Round Stock | Rectangular Stock | Tool Wt. | Shipping Wt. | Fig. No. | Price |
|----------|---------------------------------|---|----------|--------------|----------|-------|
| MIL6234 | 3 ¹ / ₂ " | 3 ¹ / ₂ " x 4 ¹ / ₂ " | 25 lbs. | 28 lbs. | 26970 | |

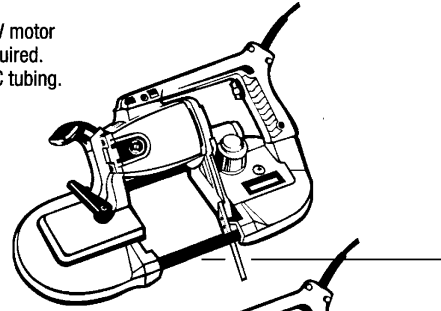

Deep Cut Portable Electric Band Saw

Our heavy duty band saw is perfect for any construction site. Makes deep cuts in a wide range of materials. Uses standard 44⁷/₈" x 1¹/₂" x .020 band saw blades. It has a 6.0 amp, 120V motor and trigger speed control. Cuts 0-350 surface feet per minute. The gear drive mechanism is grease lubricated—no oiling required. Precision ball bearing blade guide. Front T-handle for better control. Comes with steel carrying case.

| Part No. | Round Stock | Rectangular Stock | Tool Wt. | Shipping Wt. | Fig. No. | Price |
|----------|---------------------------------|---|-------------------------------------|-------------------------------------|----------|-------|
| MIL6238 | 4 ³ / ₄ " | 4 ³ / ₄ " x 4 ³ / ₄ " | 27 ¹ / ₂ lbs. | 31 ¹ / ₂ lbs. | 43737 | |

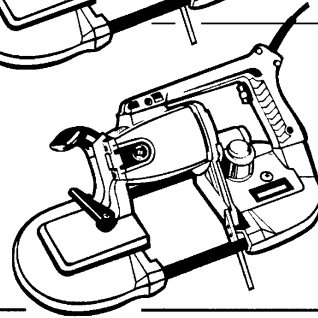

Milwaukee Circular Saw

This 10¹/₄" heavy duty circular saw has a powerful 15 amp motor and a spindle lock for fast and easy blade removal. Balanced for ease of operation. Lower guard contour lip designed for smoother retraction. Quick return heavy-duty safety telescoping guard. Comes with combination/rip saw blade and 9¹/₁₆" wrench.

| Part No. | Speed RPM | Arbor | Depth of cut at 90° | Max. Wt. Depth of cut at 45° | Shipping Wt. | Fig. No. | Price |
|----------|-----------|-------|---|---|-------------------------------------|----------|-------|
| MIL6460 | 5200 | 5/8" | 5 ¹ / ₁₆ " to 3 ¹³ / ₁₆ " | 5/8" to 2 ³ / ₄ " | 19 ¹ / ₂ lbs. | 26981 | |

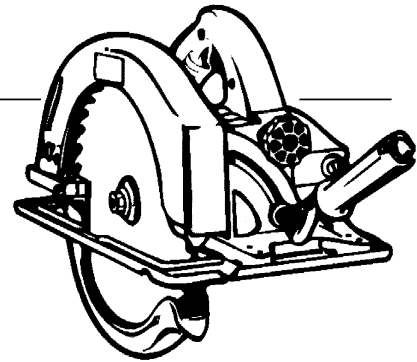

Electric Chain Saw

16" bar, 1800 ft. per minute chain speed and powerful 2.25 HP motor
 • Lightweight • Quiet, smooth-running motor • Instant starting even in freezing temperatures • No flammable fuel required • no engine exhaust
 • 120V AC only • 13 amps • Chain speed 1,800 rpm • Automatic oiling
 • 6.5 oz. Capacity. Sufficient for 1 hr of continuous operation. • Adjustable clutch—protects motor and mechanism from harmful binding. Sprocket nose bar for reduced friction. Hand guard actuated brake with resettable lockout switch. Low kickback bar and chain combination. Convenient brush replacement. Easy chain adjustment—simply loosen one nut and adjust. 8' cord.

Standard Equipment:

Chain saw, 16" Sprocket Tip Bar, 3/8" pitch chain 13mm wrench, screwdriver and scabbard.

| Part No. | Description | Net Wt. Lbs. | Ship Wt. Lbs. | Fig. No. | Price |
|----------|--------------|--------------------------------|---------------|----------|-------|
| MIL6215 | 16" Bar Size | 11 ¹ / ₄ | 14 | 26964 | |

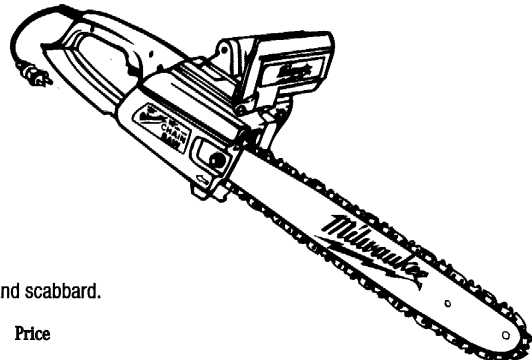

MILWAUKEE TOOLS

Milwaukee Chop Saw

This heavy-duty chop saw is designed for maximum cutting efficiency in any shop or job site location. Powerful 15 amp motor, huge cutting capacity, rugged construction to provide stable cutting of angle iron, pipe, tubing, conduit and channels. 14" blade, 1" arbor. Comes with Vice, Abrasive Wheel, Open End Wrench, and Spanner Wrench.

| Part No. | Speed (No load) RPM | O.D. Pipe | Capacity Bar Stock | Square Stock | Weight (lbs.) | Shipping Weight (lbs.) | Fig. No. | Price |
|------------|---------------------------|--------------|--------------------------|-----------------|------------------|------------------------------|-------------|-------|
| MIL 6175-6 | 3350 | 5" | 2" | 4" | 40 | 45 | 26963 | |

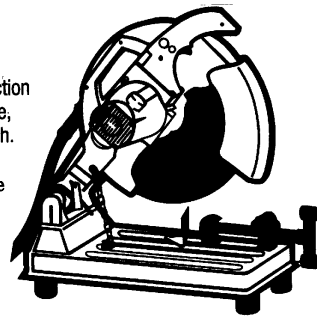

Milwaukee Circular Saw

This 7 1/4" heavy-duty circular saw is preferred by professionals for power and performance. Powerful 13 amp motor, spindle lock for fast, easy blade removal. One knob adjustment for height and one lever adjustment for angle. Comes with combination/rip saw blade and 9/16" wrench.

| Part No. | Speed (No load) RPM | Arbor | Depth of Cut at 90° | Max. Depth of Cut at 45° | Weight (lbs.) | Shipping Weight (lbs.) | Fig. No. | Price |
|------------|---------------------------|-------|---------------------------|--------------------------------|------------------|------------------------------|-------------|-------|
| MIL 6365-6 | 5800 | 5/8" | 2 3/8" | 1 25/32" | 11.5 | 16.5 | 16834 | |

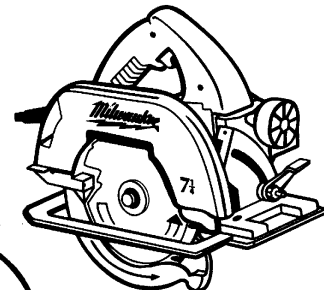

Milwaukee Circular Saw

This 8 1/4" heavy-duty circular saw has a powerful 13 amp motor and a spindle lock. Balanced for ease of operation. Lower guard contour lip designed for smoother retraction. Quick return heavy-duty safety telescoping guard. Comes with combination/rip saw blade and 9/16" wrench.

| Part No. | Speed (No load) RPM | Arbor | Depth of Cut at 90° | Max. Depth of Cut at 45° | Weight (lbs.) | Shipping Weight (lbs.) | Fig. No. | Price |
|------------|---------------------------|-------|---------------------------|--------------------------------|------------------|------------------------------|-------------|-------|
| MIL 6405-6 | 5800 | 5/8" | 2 3/4" | 2 1/8" | 13 | 18 | 26978 | |

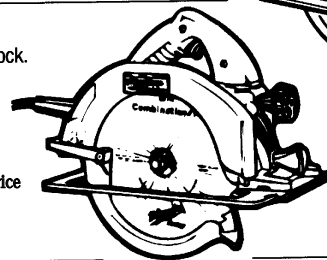

Milwaukee Worm Drive Circular Saws

These heavy-duty worm drive saws are specifically designed for the toughest applications. They both have powerful 15 amp motors, spindle locks and all ball and roller bearings. Rigid steel wraparound shoe for maximum strength and accuracy. Comes with combination blade and 9/16" wrench.

| Part No. | Speed (No load) RPM | Arbor | Depth of Cut at 90° | Max. Depth of Cut at 45° | Weight (lbs.) | Shipping Weight (lbs.) | Fig. No. | Price |
|------------|---------------------------|-------|---------------------------|--------------------------------|------------------|------------------------------|-------------|-------|
| MIL 6377-6 | 4400 | ◇ | 0 to 2 3/8" | 0 to 1 7/8" | 16.75 | 19.75 | 26975 | |
| MIL 6378 | 4400 | ◇ | 0 to 2 7/8" | 0 to 2 1/4" | 17.25 | 20.25 | 26976 | |

Circular Saw Blades found on pages 72, 73.

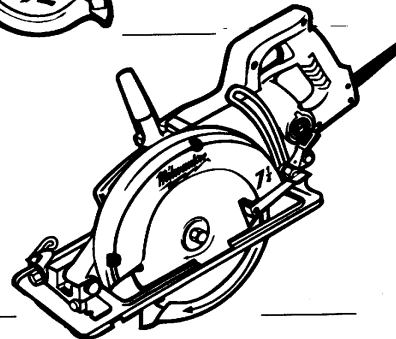

Milwaukee Jigsaws

These double insulated, variable speed jigsaws provide speed plus a full 1" blade stroke, the best combination for fast, efficient cutting. The Model 6256 has a 3.8 amp 120 volt (AC only) motor, plus added saw blade support with roller bearings for greater control and less blade breakage. Secure holding blade clamp for simple, fast blade changes. Top handle contoured for comfort and control. Counter balanced for smoother operation. Comes with jigsaw blade assortment for wood and metal. The Model 6266-6 has a 5.7 amp 120 volt (AC only) motor, and an on-off trigger switch with dial adjusted speed from 450-3100 SPM. Thumbwheel speed control presets speed with electronics that hold constant SPM under all load conditions. Quik-lok blade system lets you simply and instantly change blades - no tools required. Comes with anti-splintering device, two accessory blades, plastic shoe cover, and hex key.

| Part No. | Strokes Per Minute | Length (In.) | Width (In.) | Height (In.) | Weight (lbs.) | Shipping Weight (lbs.) | Fig. No. | Price |
|------------|--------------------------|-----------------|----------------|-----------------|------------------|------------------------------|-------------|-------|
| MIL 6256-6 | 3100 | 10 3/8" | 2 7/8" | 8 1/2" | 5.75 | 6.75 | 45320 | |

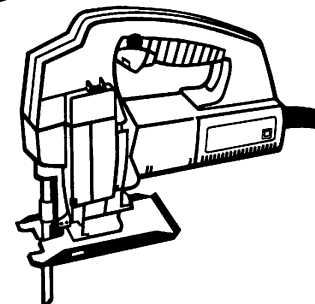

MILWAUKEE TOOLS

Heavy Duty 2" Diameter Die Grinders

These die grinders are strong, lightweight and powerful. Models 5192 (with toggle switch) and 5194 (with paddle switch) have 4.5 amp, 120V (AC/DC) motors, with a speed of 21,000 rpm. The Model 5196 has an 11 amp, 120V (AC/DC) motor, with a speed of 14,500 rpm.

| Part No. | Max. Grinding Wheel Dia. | | Length | Tool Wt. | Shipping Wt.(lbs.) | Fig. No. | Price |
|----------|--------------------------|----------------|---------|------------|--------------------|----------|-------|
| | Reinforced/Org. | Non-reinforced | | | | | |
| MIL 5192 | 2" | 15/8" | 13 1/2" | 4 1/2 lbs. | 4 3/4 | 26765 | |
| MIL 5196 | 2" | 2" | 21 1/2" | 7 3/4 lbs. | 8 3/4 | 26766 | |

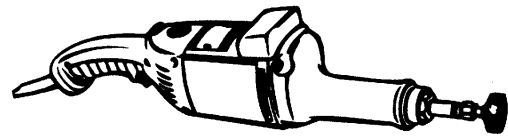

Heavy Duty 15 Amp Sander/Grinders

These 15 amp, 3.5 HP sander/grinders have a controlled start feature that drastically reduces torque reaction when starting tool...extends gear, brush and motor life. Spiral bevel gearing for smoother operation, ball bearing armature for balanced, vibration-free handling. Spindle bearing is double-sealed to prevent dust contamination in heaviest use. Self-stopping brushes stop tool when worn; prevents damage to commutator. May be converted to grinders by using proper wheel guard for grinding operations.

| Part No. | Speed | Disc Diam. | Spindle Thread | Length (less disc) | Tool Wt. | Shipping Wt.(lbs.) | Fig. No. | Price |
|----------|----------|------------|----------------|--------------------|----------|--------------------|----------|-------|
| | | | | | | | | |
| MIL 6096 | 6000 rpm | 7" - 9" | 5/8"-11" | 17 1/2" | 12 lbs. | 16 3/4 | 26957 | |

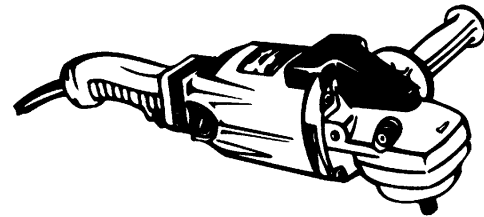

Heavy Duty 15 Amp Grinder

This powerful 15 amp, 3.5 HP grinder has similar features to the 6095 and 6096 sanders, but runs at 8000 rpm for super fast grinding. **Not recommended for sanding.** Controlled Start feature extends tool life. Line lock-out feature prevents tool from operating should voltage be restored to an interrupted line when switch is locked in the on position.

| Part No. | Speed | Disc Diam. | Spindle Thread | Length (less disc) | Tool Wt. | Shipping Wt.(lbs.) | Fig. No. | Price |
|----------|-------|------------|----------------|--------------------|----------|--------------------|----------|-------|
| | | | | | | | | |

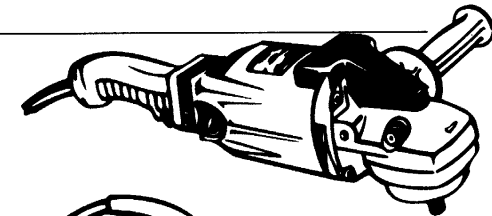

Heavy Duty 4" High Performance Belt Sanders

Our sturdy, double-insulated 120V belt sanders are built for continuous production use. Powerful 10 amp motor for fast material removal with or without built-in dust collection vacuum system. Belt speed is 1400 sfpm. Improved belt/tracking adjustment, release lever for quick belt change. Comes with 4" x 24" 80 grit sanding belt.

| Part No. | Description | Tool Weight | Shipping Weight | Fig. No. | Price |
|----------|---------------------------------|-------------|-----------------|----------|-------|
| | | | | | |
| MIL 5936 | Belt Sander with Dust Collector | 14 1/2 lbs. | 17 1/2 lbs. | 45313 | |

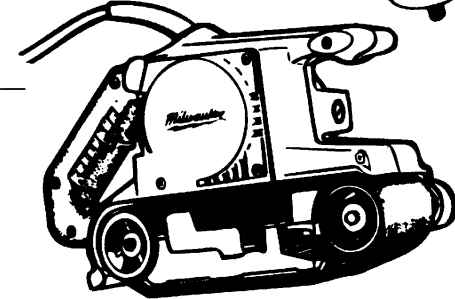

Heavy Duty 5" Straight Grinder

This grinder has a heavy-duty, 12 amp, 120v (AC/DC) motor, with a speed of 7000 rpm. Features include self-stopping, long life brush system, ball bearing mounted armature, and coated spindle housing for cool gripping surface.. Comes with one 24 grit, 5" grinding wheel, wheel guard and two wrenches.

| Part No. | Hole Diameter | Length | Weight Lbs. | Shipping Wt. | Fig. No. | Price |
|----------|---------------|--------|-------------|--------------|----------|-------|
| | | | | | | |

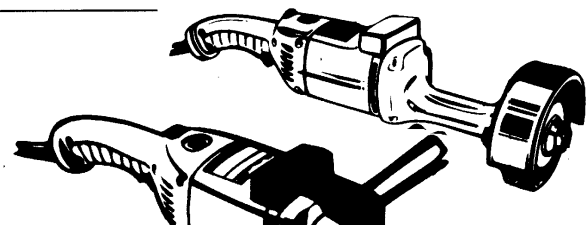

Heavy Duty Polisher

Our lightweight, rugged polisher is built for hard use. Powerful 11 amp, 120v AC motor. Self-stopping brush system for long life. All ball and roller bearings for smooth running. Used with standard liquid polishes.

| Part No. | Speed | Pad Diam. | Length | Tool Wt. | Shipping Wt.(lbs.) | Fig. No. | Price |
|----------|-------|-----------|--------|----------|--------------------|----------|-------|
| | | | | | | | |

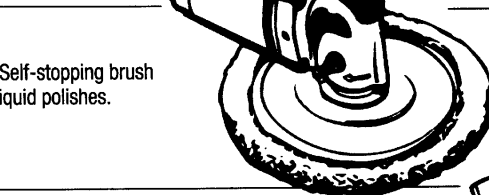

Heavy Duty Bench Grinders

All of these bench grinders come with lighted eye shields, one coarse and one medium grinding wheel. The model 4931 has a 3.8 amp, 1/3 HP, 115V motor, with a speed of 3450 rpm. The model 5051 has a 4.4 amp, 3/4 HP, 115V motor, with a speed of 3450 rpm. The model 5091 has an 8.5/4.2 amp, 1 HP, 115/230V motor, with a speed of 1725 rpm.

| Part No. | Wheel Size | Spindle (Arbor Size) | Space Betw'n Wheels | Shipping Wt. | Fig. No. | Price |
|----------|------------|----------------------|---------------------|--------------|----------|-------|
| | | | | | | |
| MIL 5051 | 8" | 3/4" | 15 5/8" | 57 lbs. | 45304 | |
| MIL 5091 | 10" | 3/4" | 17 3/8" | 90 lbs. | 45305 | |

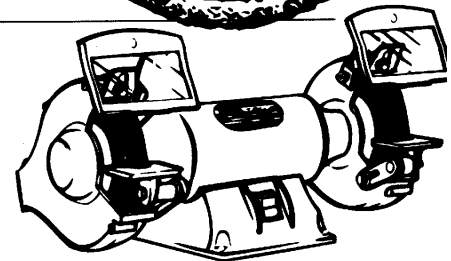

MILWAUKEE TOOLS

Milwaukee Heavy Duty Sander/Grinders

These grinders takes 4 1/2" grinding wheels. The Model 6140 has a heavy-duty, 5.5 amp, 120v (AC/DC) motor, with a speed of 10,000 rpm. Features include a reversible side handle, a paddle switch for one-handed operation, and a guard single screw mount. Comes with one 24 grit, 4 1/2" grinding wheel, flange, open-end wrench and spanner wrench. The Model 6148-6 has a double-insulated, heavy-duty, 7.5 amp, 120v (AC/DC) motor, with a speed of 10,000 rpm. Features include a spindle lock for easy accessory changes; a 5-position, quick-set disc guard; a 3-position side handle; ergonomic body style with paddle switch and integrated lock-on/lock-off buttons. Comes with 4 1/2" grinding wheel, flange, and spanner wrench.

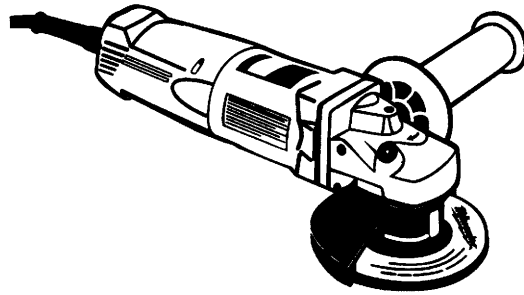

| Part No. | Spindle Size | Length | Weight Lbs. | Shipping Wt. | Fig. No. | Price |
|-------------------|--------------|---------|-------------|--------------|----------|-------|
| MIL 6140-6 | 5/8" - 11" | 10 1/2" | 4 1/2 | 6 1/4 lbs. | 45315 | |
| MIL 6148-6 | 5/8" - 11" | 14" | 4.9 | 6.2 lbs. | 57744 | |

Abrasive Products found on pages 57, 58, 62, 69, 96, 97, 108.

Milwaukee Heavy Duty 15 Amp Sander/Grinders

This 15 amp, 3.5 HP sander/grinder has a controlled start feature that drastically reduces torque reaction when starting tool... extends gear, brush and motor life. Spiral bevel gearing for smoother operation, ball bearing armature for balanced, vibration-free handling. Spindle bearing is double-sealed to prevent dust contamination in heaviest use. Self-stopping brushes stop tool when worn; prevents damage to commutator. May be converted to grinder by using proper wheel guard for grinding operations.

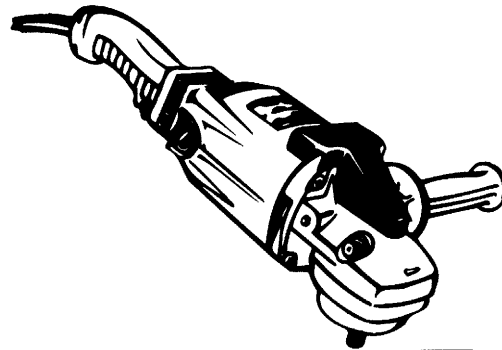

| Part No. | Speed | Disc Diam. | Spindle Thread | Length (less disc) | Tool Wt. | Shipping Wt. (lbs.) | Fig. No. | Price |
|-----------------|----------|------------|----------------|--------------------|----------|---------------------|----------|-------|
| MIL 6096 | 6000 rpm | 7" - 9" | 5/8"-11" | 17 1/2" | 12 lbs. | 16 3/4 | 28957 | |

Milwaukee 3/8" Hammer Drill

Our compact, lightweight reversible drill has a powerful 5 amp motor with a speed of 0-2,500 RPM. Capable of delivering up to 50,000 blows per minute. Designed for fast percussion drilling in concrete or masonry and high speed drilling without hammering in wood or metal. Comes with depth gauge, removable side handle, rubber dust shield, 3/8" industrial, geared, key-type chuck and chuck key with holder.

| Part No. | Spindle Thread | Length | Weight Lbs. | Shipping Wt. (lbs.) | Fig. No. | Price |
|-------------------|----------------------------------|--------|-------------|---------------------|----------|-------|
| MIL 5392-6 | 3/8" - 24 | 11" | 4 1/2 | 7 | 20938 | |
| MIL 5397-6 | Same as above with case and bits | | | 7 | 16808 | |

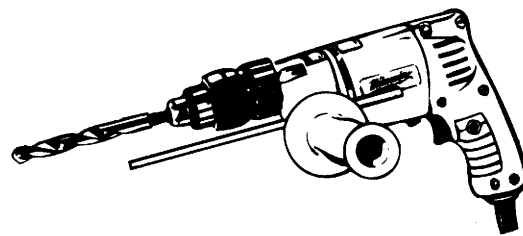

| CAPACITIES | | | |
|---------------------------|--------------------------|------------------------|-----------------|
| TWIST DRILL BITS IN STEEL | FLAT BORING BITS IN WOOD | IN CONCRETE OR MASONRY | |
| | | CARBIDE TIP BITS | SCREW FASTENERS |
| 3/8" | 3/4" | 9/16" | 3/16" |



YOU ARE ALWAYS WELCOME AT
DUFF COMPANY!

COME VISIT US ANYTIME!
201 E. LAFAYETTE STREET
NORRISTOWN, PA 19401

MILWAUKEE TOOLS

Milwaukee Metal Cutting Shear

This heavy-duty 360° swivel head shear cuts round holes, square holes or irregular holes in 18 gauge sheet metal or 20 gauge stainless. Powerful 3.5 amp motor cuts up to 15 feet per minute. Trigger speed control lets you change your cutting speed. Start slow when location is critical; increase speed for long, unobstructed cuts.

| Part No. | Spindle Speed RPM | Max. Radius | Tool Weight | Shipping Weight | Fig. No. | Price |
|----------|-------------------|-------------|-------------|-----------------|----------|-------|
| MIL 6850 | 0-2500 | 7" | 4 lbs. | 6 lbs. | 27003 | |

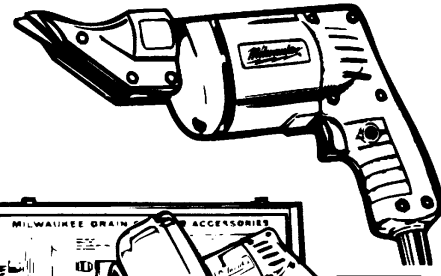

Milwaukee Drain Cleaner

This heavy-duty pistol style drain cleaner holds up to 35' of 3/8" or 50' of 5/16" inner core cable for quick, easy rodding of up to 2" wastelines. Keyless chuck offers quick hand tightening and cable feed. Trigger speed control – reversing motor protects cable from damage. Comes in steel carrying case with a selection of cables.

| Part No. | Speed No Load RPM | Max. Pipe Size I.D. | Tool Weight | Shipping Weight | Fig. No. | Price |
|-----------|-------------------|---------------------|-------------|-----------------|----------|-------|
| MIL0567-1 | 0-450 | 2" | 7.25 lbs. | 34 lbs. | 19736 | |

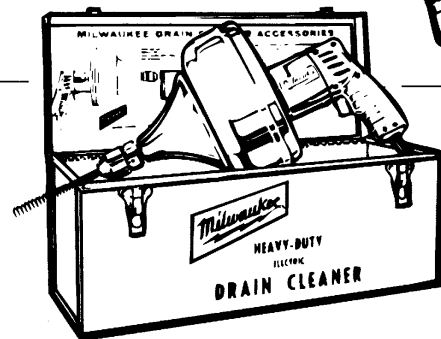

Milwaukee Screwgun

An economical double-insulated screwgun with 3.5 amps of variable speed power. Lightweight and compact for easy use in tight quarters. Reversing trigger speed control switch. Positive lock adjustment provides a wide range of depth settings.

| Part No. | RPM No Load | Bit Shank Size | Tool Weight | Shipping Weight | Fig. No. | Price |
|------------|-------------|----------------|-------------|-----------------|----------|-------|
| MIL 6758-6 | 0-4000 | 1/4" Hex | 3 1/8 lbs. | 4 1/2 lbs. | 49867 | |

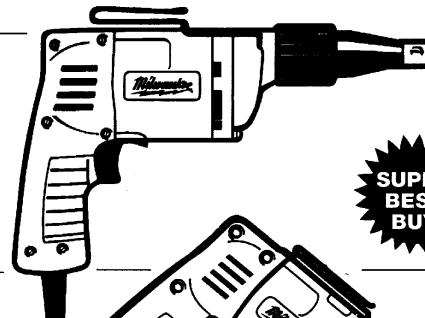

Milwaukee Tek Driver

For driving self-drilling, self-tapping screws. 5 amp, variable speed reversing motor. Positive drive clutch engages when pressure is applied. Driving action stops and clutch disengages when pressure is released or when locator contacts work surface. Depth control is adjustable in increments of 1/64" from outside of tool.

| Part No. | RPM No Load | Bit Shank Size | Tool Weight | Shipping Weight | Fig. No. | Price |
|------------|-------------|----------------|-------------|-----------------|----------|-------|
| MIL 6798-6 | 0-2500 | 1/4" Hex | 3 3/4 lbs. | 5 1/2 lbs. | 26999 | |

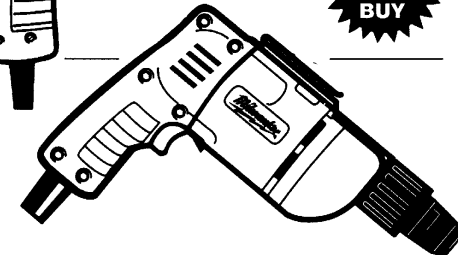

Milwaukee Heavy-Duty Heat Guns

Use these double-insulated 11.6 amp heat guns wherever portable, flameless heat is required. The Model 8975 is dual temperature (570° and 1000°). The Model 8977 is variable temperature (212° to 1000°).

| Part No. | Air Vol. Cu. Ft./Min. | Length | Tool Weight | Shipping Weight | Fig. No. | Price |
|------------|-----------------------|---------|-------------|-----------------|----------|-------|
| MIL 8975-6 | 14.8 | 10 1/8" | 1.6 lbs. | 2 lbs. | 27018 | |
| MIL 8977 | 14.8 | 10 1/8" | 1.6 lbs. | 2 lbs. | 30798 | |

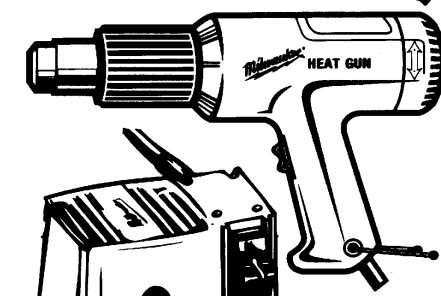

Milwaukee Router

This 2 H.P., 12 amp router is powerful and lightweight for extra heavy-duty jobs. Functional trigger-handle grouping and a flat top for steady positioning. Heavy-duty sub base with large openings for maximum visibility. Comes with 1/4" Collet, 1/2" Collet, 7/8" open end wrench, 1 1/4" open end wrench, and Router Base.

| Part No. | RPM No Load | Collet Capacity | Tool Weight | Shipping Weight | Fig. No. | Price |
|----------|-------------|-----------------|-------------|-----------------|----------|-------|
| MIL 5681 | 26,000 | 1/4"-3/8"-1/2" | 8 3/4 lbs. | 11 1/4 lbs. | 57738 | |

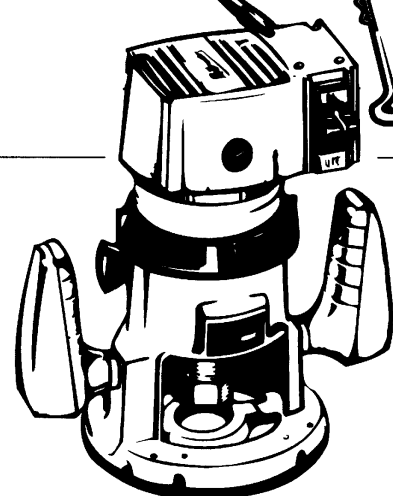

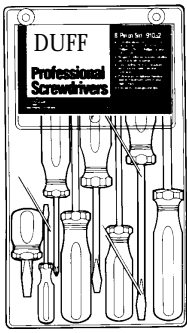

7 PC. SCREWDRIVER SET - professional quality; 6150 chrome vanadium steel; supersize jumbo handles; tips cross ground for perfect fit; space age rust proof finish.

| FIG. NO. | PRICE |
|----------|-------|
| 15524 | |

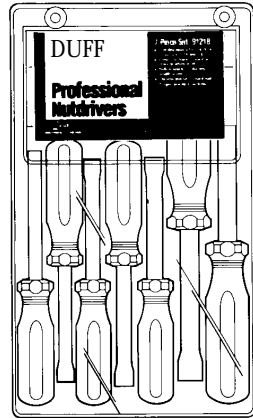

7 PC. DELUXE NUT DRIVER SET - packed in vinyl pouch for easy storage.

| FIG. NO. | PRICE |
|---------------|-------|
| 15527 | |
| LONG 6" REACH | |
| 43557 | |

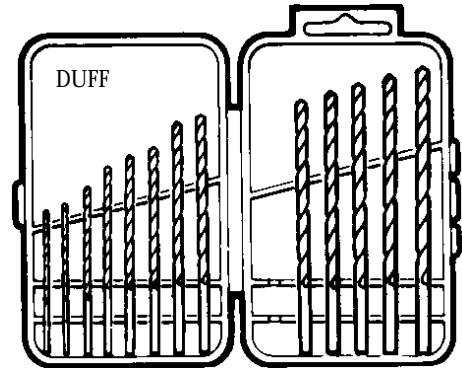

13 PIECE TWIST DRILL SET - durable plastic case. Each drill is easily accessible, yet firmly held in place. Sizes marked clearly and include 1/16, 5/64, 3/32, 7/64, 1/8, 9/64, 5/32, 11/64, 3/16, 13/64, 7/32, 15/64, 1/4 inch. Space provided for center punch.

| FIG. NO.. | PRICE |
|-----------|-------|
| 15512 | |

**GRIPPED
ADJUSTABLE WRENCH**

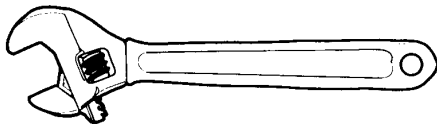

COATED HANDLE!

| SIZE | FIG. NO. | PRICE |
|------|----------|-------|
| 4" | 27480 | |
| 6" | 27481 | |
| 8" | 19774 | |
| 10" | 19775 | |
| 12" | 27482 | |

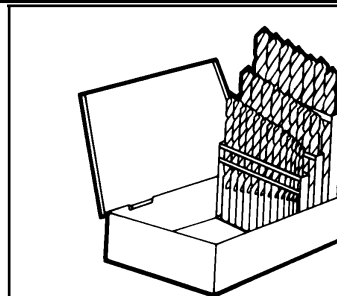

29 PC. DRILL BIT SET - In metal case for easy storage.

| FIG. NO. | PRICE |
|----------|-------|
| 72703 | |

**MAGNA™
PROFESSIONAL TOOLS**

6 IN ONE SCREWDRIVER

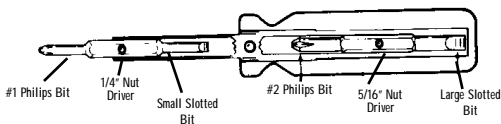

6 IN ONE SCREWDRIVER

| FIG. NO. | PRICE |
|----------|-------|
| 63411 | |

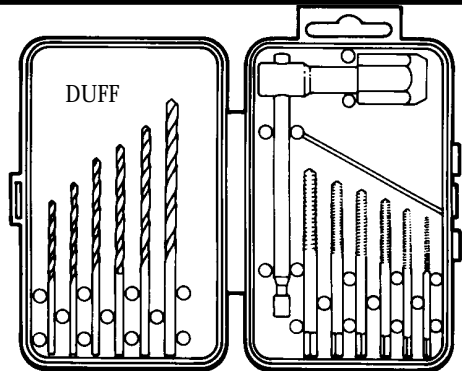

13 PIECE TAP AND DRILL SET - holds 6 carbon taps and 6 high speed steel twist drills to match, plus T-handle wrench. Taps and drills are rigidly held in durable molded plastic case. Tap sizes: 4-40, 6-32, 8-332, 10-24, 0-32, 1/4-20. Drill sizes: NOs 43, 36, 29, 25 21, 7.

| FIG. NO. | PRICE |
|----------|-------|
| 15517 | |

TAPS AND DIES & DRILL



WATCHA-CALLIT KIT
29 Piece magnetic screwdriver set with bits

| FIG. NO. | PRICE |
|----------|-------|
| 44456 | |

HIGH SPEED TWIST DRILLS

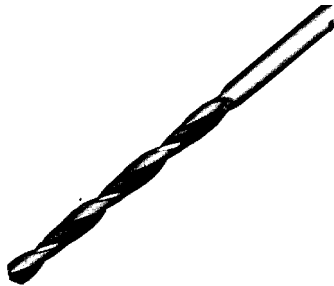

| DIA | OVER ALL LENGTH | LENGTH OF TWIST | FIG. NO. | PRICE |
|-------|-----------------|-----------------|----------|-------|
| 1/16 | 2 5/8 | 7/8 | 15472 | |
| 5/64 | 2 3/4 | 1 | 15473 | |
| 3/32 | 2 7/8 | 1 1/4 | 15474 | |
| 7/64 | 3 1/8 | 1 1/2 | 15475 | |
| 1/8 | 3 1/4 | 1 5/8 | 15476 | |
| 9/64 | 3 1/2 | 1 3/4 | 15477 | |
| 5/32 | 3 5/8 | 2 | 15478 | |
| 11/64 | 3 3/4 | 2 1/8 | 15479 | |
| 3/16 | 3 7/8 | 2 5/16 | 15480 | |
| 13/64 | 4 | 2 7/16 | 15481 | |
| 7/32 | 4 1/8 | 2 1/2 | 15482 | |
| 15/64 | 4 1/4 | 2 5/8 | 15483 | |
| 1/4 | 4 3/8 | 2 3/4 | 15484 | |
| 17/64 | 4 1/2 | 2 7/8 | 15485 | |
| 9/32 | 4 5/8 | 2 15/16 | 15486 | |
| 19/64 | 4 3/4 | 3 1/16 | 15487 | |
| 5/6 | 4 7/8 | 3 3/16 | 15488 | |
| 21/64 | 5 | 3 5/16 | 15489 | |
| 11/32 | 5 1/8 | 3 7/16 | 15490 | |
| 23/64 | 5 1/4 | 3 1/2 | 15491 | |
| 3/8 | 5 3/8 | 3 5/8 | 15492 | |
| 25/64 | 5 1/2 | 3 3/4 | 15493 | |
| 13/32 | 5 5/8 | 3 7/8 | 15494 | |
| 27/64 | 5 3/4 | 3 15/16 | 15496 | |
| 7/16 | 5 7/8 | 4 1/16 | 15497 | |
| 29/64 | 6 | 4 3/16 | 15498 | |
| 15/32 | | 4 15/16 | 15499 | |
| 31/64 | | 4 3/8 | 15500 | |
| 1/2 | | 4 1/2 | 15501 | |

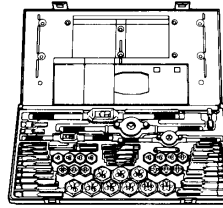

58 PIECE MASTER MECHANIC'S SET
(hexagon dies) in molded plastic case. 23 cuts, 23 taps, 17 one inch hexagon dies, 6 17/16 hexagon dies. See sizes and types of threads in table below. Also includes tap and reamer wrenches, 2 die stocks, T-handle tap wrench, 1 screw pitch gauge, 1 screwdriver, and Nos. 1-5 screw extractors.

SIZES AND THREADS PER INCH

| | | | | | | | |
|-----|--------|--------|--------|--------|--------|--------|---------|
| NC | 6-32 | 1/8-27 | 8-32 | 10-24 | 12-24 | 1/4-20 | 5/16-18 |
| | 7/16- | | 1/2-13 | 9/16 | 5/8- | 3/4-10 | 18 |
| NF | 14 | | 1/4-28 | 5/6-24 | 3/8-24 | 7/16- | |
| | 10-32 | | 3/4-16 | | | 20 | /2-20 |
| NPT | 5/8-18 | | 1/4-18 | | | | |

| FIG. NO. | PRICE |
|----------|-------|
| 51060 | |

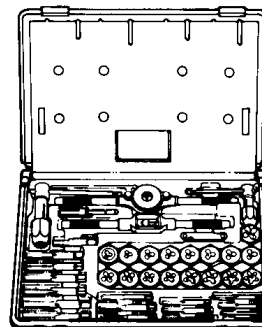

40 PIECE PROFESSIONAL MECHANIC'S SET
17 plug taps, 17 1" hexagon dies, 1 die stock, 1 tap wrench, 2 T-handle wrenches, 1 screw pitch gauge and 1 screwdriver.

SIZES AND THREADS PER INCH

| | | | | | | | | |
|-----|--------|--------|-------|--------|-------|--------|------|--------|
| NC | 4-40 | 6-32 | 8-32 | 10-24 | 12-24 | 1/4-20 | 5/16 | 3/8-16 |
| | 7/16-4 | 1/2-13 | | | | | | |
| NF | 10-32 | 1/4-28 | 5/16- | 3/8-24 | 7/16- | 1/2-20 | | |
| NPT | 1/8-27 | | 24 | | 20 | | | |

| FIG. NO. | PRICE |
|----------|-------|
| 15515 | |

MASONRY DRILL BITS

Rotary carbide

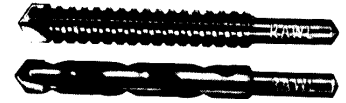

| SIZE | FIG. NO. | PRICE |
|---------|----------|-------|
| 1/4 x 4 | 13709 | |
| 5/16x4 | 19021 | |
| 3/8 x 4 | 13710 | |
| 1/2 x 4 | 13712 | |
| 5/8 x 6 | 13713 | |
| 3/4 x 6 | 13714 | |

DOUBLE RATCHET WRENCH



| FIG. NO. | PRICE |
|----------|-------|
| 51048 | |

2-WATT UHF MODEL WALKY-TALKY

Spirit Pro+
SU21/SU21C/SU21CD Series

- *1-channel operation
- *2-Watt power output
- *8 UHF frequencies
- *Range maximizing receiver (RMR) for up to a 5-mile talk range (line of sight)
- *Compact size
- *Open or coded squelch communication
- *Transmit/battery status indicator
- Audio accessory connector
- *Rechargeable batteries for up to 8 hours of use

*Desktop charging capability
-SU2/SU21C require optional desktop charger converter kit and desktop charger
-SU2CD requires optional desktop charger only.

*Packaged with Radio, Antenna, Belt clip, Rechargeable battery, 10-hour wall charging adapter, operator's manual and FCC license info.



For additional information call: 610-275-4453 or Fax: 610-279-6299
Please call for current prices.

PLEASE CALL US FOR PRICING!

SMALL TUBING RADIUS TUBING CUTTER



- Only requires 1 1/4" radius
- For 1/8" O.D. to 1/2" O.D. tubing

| FIG. NO. | PRICE |
|----------|-------|
| 50696 | |

Copper Shut-Off Tool

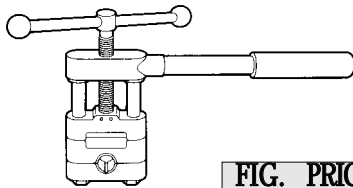

| DESCRIPTION | FIG. NO. | PRICE |
|-------------------------|----------|-------|
| 3/4" - 1" Pipe Capacity | CSO1 | |
| 1 1/4" - 2" Capacity | CSO2 | |

RATCH-CUT COPPER TUBE CUTTER



Ratch-Cut is designed and engineered to do a fast, clean, professional job. It cuts copper, plastic and PVC pipe in dimensions from 5/16" to 1 1/8". High impact fiberglass handle is strong and light weight.

| OEM # | FIG. NO. | PRICE |
|--------------------|----------|-------|
| RC375 | 38931 | |
| RC1125 | 38932 | |
| WHEELS ONLY | | |
| RC375 | 38933 | |
| RC1125 | 38934 | |

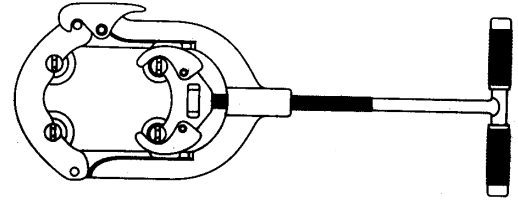

Large Cutters

| DESCRIPTION | FIG. NO. | PRICE |
|---------------------------------|----------|-------|
| Steel, 1" - 2 1/2" | H2 1/2S | |
| CI/DUC, 1" - 2 1/2" | H2 1/21 | |
| Steel extra heavy, 1" - 2 1/2" | H2 1/2X | |
| Steel, 2" - 4" | H4S | |
| CI/DUC, 2" - 4" | H41 | |
| Steel extra heavy, 2" - 4" | H4X | |
| Steel, 4" - 6" | H6S | |
| CI/DUC, 4" - 6" | H61 | |
| Steel extra heavy, 4" - 6" | H6X | |
| Steel, 6" - 8" | H8S | |
| CI/DUC, 6" - 8" | H81 | |
| Steel extra heavy, 6" - 8" | H8X | |
| Steel dbl extra heavy, 6" - 8" | H8XX | |
| Steel, 8" - 12" | H12S | |
| CI/DUC, 8" - 12" | H121 | |
| Steel extra heavy, 8" - 12" | H12X | |
| Steel dbl extra heavy, 8" - 12" | H12XX | |

Universal Pipe Cutter

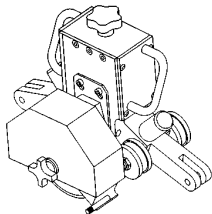

| DESCRIPTION | FIG. NO. | PRICE |
|-------------------------|----------|-------|
| Pneumatic cut. 6" - 16" | UPC616A | |
| Hydraulic cut. 6" - 16" | UPC616H | |
| Pneumatic cut. 6" - 36" | UPS636A | |
| Hydraulic cut. 6" - 36" | UPC636H | |
| Pneumatic cut. 6" - 48" | UPC648A | |
| Hydraulic cut. 6" - 48" | UPC648H | |

Tapping Machine

| DESCRIPTION | FIG. NO. | PRICE |
|---------------------------|----------|-------|
| 3/4" - 1" Tapping Machine | TM1000 | |



RIDGID

Tube Bender

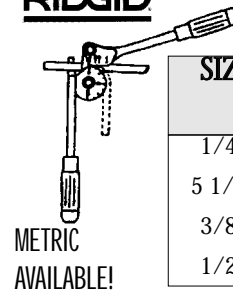

METRIC AVAILABLE!

| SIZE | FIG. NO. | PRICE |
|--------|----------|-------|
| 1/4" | 23167 | |
| 5 1/6" | 27606 | |
| 3/8" | 43740 | |
| 1/2" | 43741 | |



AUTOCUT Copper Tubing Cutter

This is a great tool to have when you don't have enough swing room to use a full size tubing cutter. Cut copper tubing with less than one inch of clearance. Easily handle cose stub out work.

Snap it on the tube, close the grate and turn in either direction. Cutter wheel automatically tightens as you turn. Has long lasting steel cutting wheels



| | FIG. NO. | PRICE |
|------|----------|-------|
| 1/2" | DATC12 | |
| 3/4" | DATC34 | |



TOOLS FOR PLASTIC PIPE

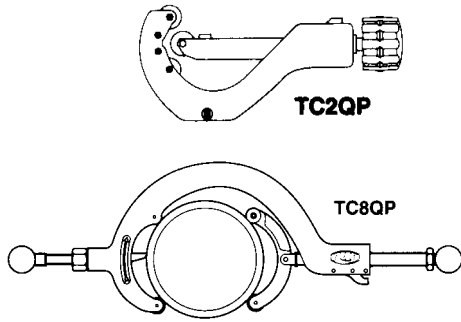

Quick release plastic pipe cutters

| DESCRIPTION | FIG. NO. | PRICE |
|----------------------------------|------------|-------|
| 1/8" - 1 5/16" W/ OP2 Wheel | TC1QP | |
| 1/8" - 1 5/16" W/ 1-2 PVC Wheel | TC1QPVC | |
| 1/4" - 2 5/8" W/OP2 Wheel | TC2QP | |
| 1/4" - 2 5/8" W/ 1-2 PVC Wheel | TC2QPVC | |
| 3/8" - 3 1/2" W/ 30-40P Wheel | TC3QP | |
| 3/8" - 3 1/2" W/3-6 PVC Wheel | TC3QPVC | |
| 3/8" - 3 1/2" W/ 6 QP Wheel | TC4QP | |
| 1 7/8" - 4 1/2" W/ 30-40P Wheel | TC4QPVC | |
| 1 7/8" - 4 1/2" W/ 306 PVC Wheel | TC4Q6QP | |
| 1 7/8" - 4 1/2" W/ 6QP Wheel | TC5QP | |
| 2 1/2" 5" W/30-40P Wheel | TC6QP | |
| 4" - 6 5/8" W/ 30-40P Wheel | TC6QPVC | |
| 4" - 6 5/8" W/ 3-6 PVC Wheel | TC6Q6QP | |
| 4" - 6 5/8" W/ 6QP Wheel | TC6Q80P | |
| 4" - 6 5/8" W/ 80P Wheel | TC6Q680PVC | |
| 4" - 6 5/8" W/ 680 PVC Wheel | TC8QP | |
| | TC8QPL | |

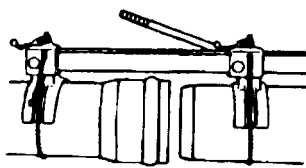

Plastic Pipe Joiner

| DESCRIPTION | FIG. NO. | PRICE |
|----------------------------|----------|-------|
| Plastic Pipe Joiner | PPJ | |
| Universal Saddles 4" - 16" | PPJVS | |
| Fitting Attachments | PPJFA | |
| 4" Saddles Pair | PPJ4S | |
| 6" Saddles Park | PPJ6S | |
| 8" Saddles Pair | PPJ8S | |
| 10" Saddles Pair | PPJ10S | |
| 12" Saddles Pair | PPJ12S | |

Cutter/Groover for Restrained Joints

| DESCRIPTION | FIG. NO. | PRICE |
|-----------------------|----------|-------|
| 4"-8" Cutter/Groover | PLGR48 | |
| 6"-12" Cutter/Groover | PLGR612 | |

SQUEEZE-OFF TOOL

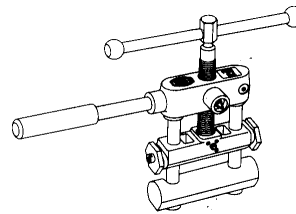

| DESCRIPTION | FIG. NO. | PRICE |
|----------------------------|----------|-------|
| 1/2" - 2" IPS Polyethylene | PES2IPS | |
| 1/2" - 2" CTS Polyethylene | PES2CTS | |

CALL DUFF FIRST FOR ALL YOUR TOOL NEEDS!

Chain & Trstrand Vises for Plastic Pipe

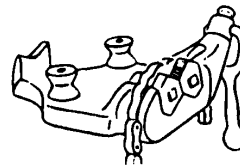

| DESCRIPTION | FIG. NO. | PRICE |
|-----------------------------|----------|-------|
| Chain Vise 1/8"-2 1/2" | CV2P | |
| Chain Vise 1/8" - 4" | CV4P | |
| Chain Vise 1/8"-5" | CV5P | |
| Trstrand chain vise 1/8"-6" | R450P | |

Plastic Pipe Bevelers

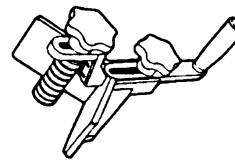

| SIZE | FIG. NO. | PRICE |
|--------------|----------|-------|
| 1 1/2" - 8" | BT1 | |
| 1 1/2" - 12" | BT2 | |

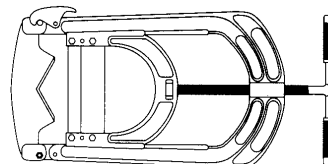

Guillotine Pipe Cutter

| SIZE | FIG. NO. | PRICE |
|-------------------|----------|-------|
| 4" | HPC4 | |
| 8" | HPC8 | |
| 8" thin wall pipe | HPC8TN | |

DEBURRING TOOL



| |
|-------|
| 71403 |
|-------|

DEBURRING TOOL

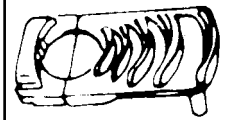

Up to 4" Pipe

| FIG. NO. | PRICE |
|----------|-------|
|----------|-------|

| |
|------|
| DEB4 |
|------|

DEBURRING TOOL

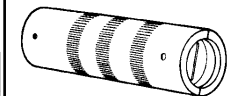

Up 3/4" - 1" Pipe

| FIG. NO. | PRICE |
|----------|-------|
|----------|-------|

| |
|------|
| DEB1 |
|------|

Water Shut-off Tool

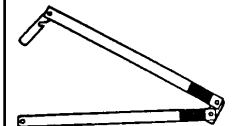

Shut-off Tool 3/4" & 1" pipe

| FIG. NO. | PRICE |
|----------|-------|
|----------|-------|

| |
|-------|
| PESO1 |
|-------|

DUFF DIFFERS!

RIDGID TUBING CUTTERS

RIDGID

Midget Tubing Cutters

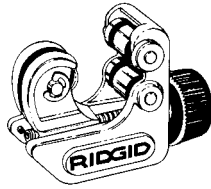

For up to 15/16" O.D. Tubing
In Extreme Close Quarters

These tubing cutters are specifically designed for use in extra close quarters on small size hard and soft copper, aluminum, brass and plastic tubing. Two rollers opposite cutter wheel permit easier rotation and faster cutting. Slide and wheel housing are strong and light weight. Large, knurled feed screw knob gives easy control of cutting pressure for cleancuts.

| OD CAPACITY | TURNING RADIUS | OEM # | FIG. NO. | PRICE |
|---------------|----------------|-------|----------|-------|
| 1/4" - 1 1/8" | 2 1/16" | 40617 | 43533 | |
| 1/8" - 5/8" | 1 5/16" max | 32975 | 13578 | |
| 1/8" - 15/16" | 1 11/16" max | 32985 | 13579 | |

RIDGID Quick-Acting Tubing Cutters

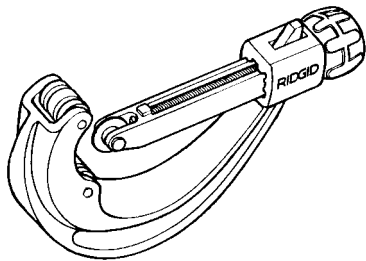

Push the cutter handle to snug the cutter wheel against tubing, press the release nut to automatically snap cutter open. Models 151-156 feature a quick-acting design, I-beam construction, hardened wear surfaces, and thrust bearing slide assemblies for smooth operation. These cutters are available in models for plastic pipe or metallic tubing. Models 151 and 152 feature fold-away reamers.

| CAPACITY OD | OEM # | FIG. NO. | PRICE |
|---------------|---------|----------|-------|
| 1/4 - 1 5/8 | 31632 | 13580 | |
| 1/8 - 1 1/4 | 31637-P | 13128 | |
| 1/4" - 2 5/8 | 31642 | 13581 | |
| 1/4 - 2 | 31647-P | 13129 | |
| 1 - 3 | 36592-P | 13130 | |
| 1 7/8 - 4 1/2 | 31652 | 13583 | |
| 1 1/2 - 4 | 31657-P | 13131 | |
| 4 - 6 5/8 | 31662 | 13584 | |

*P - Plastic Cutter



RIDGID No. 1493 Plastic Pipe and Tube Cutter

Designed for quick, clean cuts through 2 3/8" (60 mm) O.D.

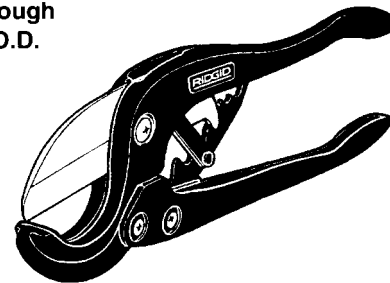

The No. 1493 features a compound leverage ratchet mechanism and a hardened steel blade. Simple operation produces quick, clean cuts with ease. The housing is made of lightweight aluminum for long trouble-free service.

CAPACITY = 1/8" - 2 3/8" OD

| OEM # | FIG. NO. | PRICE |
|-------|----------|-------|
| 12831 | 42953 | |

RIDGID Enclosed Feed Screw Tubing Cutter

Grooved Rollers for Close Flare Cut-Offs

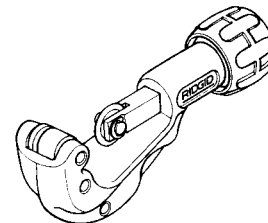

No. 150 and No. 205 feature an enclosed feed screw to eliminate clogging and jamming, grooved rolls for close-to-flare cuts, and a fold-away reamer. No. 205 has a Quick Acting Feed mechanism. Made from high-strength aluminum alloy with a spare cutter wheel in the handle. Cuts copper, brass, and aluminum tubing, and thin-wall conduit.

1/8" through 1 1/8" OD

| OEM # | FIG. NO. | PRICE |
|-------|----------|-------|
| 31622 | 38760 | |

1/4" through 2 3/8" OD

| | | |
|-------|-------|--|
| 33055 | 13586 | |
|-------|-------|--|

1/4" through 2 3/8" OD (HD)

| | | |
|-------|-------|--|
| 33070 | 34919 | |
|-------|-------|--|

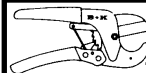

FOR PLASTIC!

CAPACITY - 1/8" - 1 1/2" OD

| OEM # | FIG. NO. | PRICE |
|-------|----------|-------|
| 91125 | 13593 | |



TUBING TOOLS

TUBING CUTTERS



NOS. 10, 15, 20 and 30
Clean, square cuts are easily made on copper, brass aluminum, and thin-wall conduit. Models 10, 15 and 20 feature a convenient fold-away reamer. Model 30 is rated for larger diameter steel and stainless steel tubing.

| FIG. NO. | MODEL NO. | DESCRIPTION | STD. WHEEL | CAPACITY (IN) | PRICE |
|----------|-----------|--------------------|------------|---------------|-------|
| 13587 | 10 | Screw Feed Cutter | F-158 | 1/8-1 | |
| 34920 | 10 | Above w/H-D Wheel | E-1240 | 1/8-1 | |
| 13588 | 15 | Screw Feed Cutter | F-158 | 3/16-1 1/8 | |
| 34921 | 15 | Above w/ H-D Wheel | E-1240 | 3/16-1 1/8 | |
| 13589 | 20 | Screw Feed Cutter | F-158 | 5/8-2 1/8 | |
| 34922 | 20 | Above w. H-D Wheel | E-1240 | 5/8-2 1/8 | |
| 13590 | 30 | Screw Feed Cutter | E-2558 | 1-3 1/8 | |
| 34923 | 30 | Above w/H-D Wheel | E-2191 | 1-3 1/8 | |

TUBING CUTTERS (ORIGINAL PRODUCT)

| | | | | | | | | | | | | | | | | | | | | | | | | | | | | | |
|-------|-------|-------|-------|-------|-------|-------|-------|-------|-------------|-------------|-------|-------|-------|-------|-------------|-------------|-------------|-------------|-------|-------|-------|-------|-------------|-------------|-------------|-------------|-------|-------|-------|
| 10 | 15 | 20 | 30 | 30P | 40 | 40P | 50 | 101 | 103/104 | 105/150 | 106 | 108 | 109 | 109P | 131/151 | 131P/151P | 132/152 | 132P/152P | 153 | 153P | 133 | 133P | 134/154 | 134P/154P | 136/156 | 136P/156P | 205 | 205P | 315 |
| 32910 | 32920 | 32930 | 32940 | 32945 | 32955 | 32960 | 41527 | 40617 | 32975/32985 | 32990/31622 | 33005 | 83240 | 83290 | 83295 | 33015/31632 | 33020/31637 | 33025/31642 | 33030/31647 | 36597 | 36592 | 33035 | 33040 | 33045/31652 | 33050/31657 | 83185/31662 | 83235/31667 | 33055 | 33065 | 33075 |



| FIG. NO. | MODEL NO. | STD. PK. | BLADE EXP. | | | | | | | | | | | | | | | | | | | | | | | | | | | | | APPLICATION |
|----------|-----------|----------|------------|---|---|---|--|---|---|---|---|---|---|---|---|---|---|---|---|---|--|--|---|---|---|---|---|--|--|---|---|-------------------------------|
| 13653 | E-702 | 1 | .500 | | | | | | | | | | | | | | | | | | | | | | | | | | | | | Heavy Wall PVC, ABS |
| 13654 | E-1240 | 12 | .162 | √ | √ | √ | | | | | | | | | | | | | | | | | | | | √ | √ | | | | | Steel - SS |
| 13655 | E-1740 | 1 | .147 | | | | | | √ | √ | √ | | | | √ | √ | √ | | | | | | | | | | | | | √ | | Soft Flexible Plastic |
| 20091 | E-2155 | 1 | .286 | | | | | | | | | | | | | x | x | x | | | | | | | | | | | | x | | PE, PB, PP, STD. & Heavy Wall |
| 28670 | E-2156 | 1 | .412 | | | | | | | | | | | | | | | | | | | | x | | x | √ | | | | | | PE, PB, PP, STD. & Heavy Wall |
| 28671 | E-2157 | 1 | .500 | | | | | | | | | | | | | | | | | | | | | | √ | | | | | | | PE, PB, PP, STD. & Heavy Wall |
| 13656 | E-2191 | 6 | .292 | | | √ | | √ | | | | | | | | | | | | | | | √ | √ | | √ | | | | | | Steel Tubing |
| 13657 | E-2558 | 6 | .220 | | | | | | | | | x | x | x | | | | | | | | | x | | | x | | | | | | Aluminum & Copper |
| 13658 | E-2880 | 1 | .747 | | | | | | | | | | | | | | | | | | | | | | | | √ | | | | | PE, PB, PP, STD. & Heavy Wall |
| 13659 | E-2990 | 1 | .112 | | | | | | | | | | | | | | | | | | | | | | | | | | | | x | Steel Aluminum & Copper |
| 13660 | E-3469 | 12 | .149 | | | | | | x | x | x | | | | x | x | x | | | | | | | | | | | | | | x | Aluminum & Copper |
| 28672 | E-3495 | 1 | .290 | | | | | | | | | | | | √ | √ | √ | | | | | | | | | | | | | | √ | Aluminum |
| 13663 | E-4546 | 6 | .162 | | | | | | | | | | | | | | | | | | | | | | | | | | | | √ | Steel - SS |
| 13665 | E-5272 | 6 | .290 | | | | | | | | | | | | | | | √ | √ | √ | | | | | | | | | | | √ | PVC, ABS, Std. Wall |
| 13666 | E-5299 | 6 | .412 | | | | | √ | √ | | | √ | √ | | | | | | | | | | | √ | √ | √ | | | | | | PVC, ABS, Std. Wall |
| 13668 | E-158 | 12 | .149 | x | x | x | | | | | | | | | | | | | | | | | | | | | | | | | | Aluminum Copper |
| 13669 | E-10279 | 1 | .185 | | | | | | | | | | | | | | | | | | | | | | √ | √ | | | | | | Think Wall PVC |

RIDGID BOLT CUTTERS



Designed for cutting rod, wire mesh, concrete form ties, cable and bolts. Slim head permits cutting close to surface. Quick, easy adjustment through use of a cam/bot mechanism. Jaws are made of hardened alloy steel.

| MODEL NO. | FIG. NO. | DESCR | CAPACITY/METALS | | | LENGTH (IN) | PRICE |
|-----------|----------|------------|-----------------|--------|------|-------------|-------|
| | | | SOFT | MEDIUM | HARD | | |
| N14S | 28679 | Center Cut | 5/16 | 1/4 | 3/16 | 15 | |
| N18S | 28680 | Center Cut | 3/8 | 5.16 | 1/4 | 19 | |
| N24S | 28681 | Center Cut | 7/16 | 3/8 | 5/16 | 26 | |
| N30S | 19499 | Center Cut | 1/2 | 7/16 | 3/8 | 31 | |
| N36S | 28682 | Center Cut | 9/16 | 1/2 | 7/16 | 38 | |
| N42S | 28683 | Center Cut | 11/16 | 9/16 | 1/2 | 44 | |

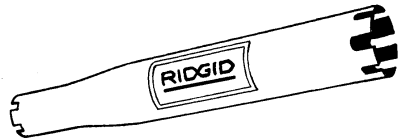
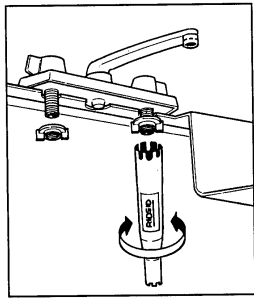

PLASTIC BASIN NUT WRENCH

This wrench is designed to reach and turn plastic mounting nuts on faucets, sprayers and ballcocks. The RIDGID basin wrench is a great addition to any tool box. The notched ends of the plastic basin nut wrench are designed to self-center on 2, 3, 4 and 6-tab nuts and to fit metal and plastic 1" hex nuts. Made of 16 gauge cold rolled steel, it features a one-piece 11" tubular steel body for both residential and commercial faucet water supply shanks. It is ideal for tight clearance pedestal sinks.

| FIG. NO. | PRICE |
|----------|-------|
| 79448 | |

BASIN WRENCHES

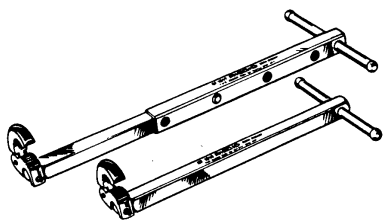

Forged alloy jaws are spring loaded to grip all nuts 3/8" through 1 1/4" across flats. You get fast, one-hand ratcheting operation in tight spots. Tension plug holds head in any position up to 90° angle. Handle and shank are chrome plated. Stainless steel spring assures firm grip after positioning jaw on nut, pipe or tube. Telescopic shank is quickly adjusted to desired length and held there by spring loaded pin.

| MODEL NO. | FIG. NO. | LENGTH | CAPACITY | PRICE |
|-----------|----------|---------|--------------------|-------|
| 1017 | 12940 | 10"-17" | 3/8"-1 1/4" Nuts | |
| 1019 | 12941 | 10"-17" | 1 1/4"-2 1/2" Nuts | |

ADJUSTABLE GRADE SCREW LEVEL

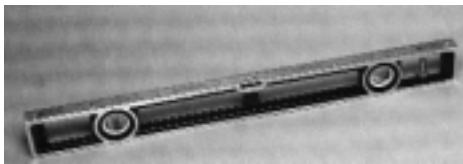

Heavy duty die cast aluminum frame. Three vials for horizontal, vertical and 45°. Top reading horizontal vial, stainless steel ruler and grade screw adjustment.

| SIZE | FIG. NO. | PRICE |
|------|----------|-------|
| 18" | 33573 | |
| 24" | 38618 | |

RIDID SWAGING TOOLS

Quality made and zinc-plated for accuracy and durability. Set of four tools is packaged in handy vinyl pouch. Designed for copper, aluminum or brass.



| MODEL NO. | FIG. NO. | CAPACITY (INCH) | PRICE |
|-----------|----------|--------------------|-------|
| 570 | 13621 | 1/4, 3/8, 1/2, 5/8 | |
| 562 | 27583 | 1/4 | |
| 563 | 27584 | 3/8 | |
| 564 | 27585 | 1/2 | |
| 565 | 27586 | 5/8 | |



WE STOCK PARTS FOR THE TOOLS WE SELL!

RIDGID CUTTERS AND FLARING TOOLS

RIDGID

No. 102

Internal Tubing Cutter

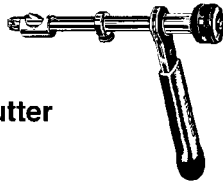

This handy cutter accurately cuts 1/2" and 3/4" I.D. copper water tube close to floors or joists or close together. Length of tube to be cut ranges from 3/16" to 4 1/2". Ratchet handle with comfortable plastic grip requires minimum operating space. Large feed knob gives easy control of lathe type cutoff tool that leaves no burr. Reamer-like point gives easy entry into out-of-round or burred tubes.

1/2" and 3/4" ID copper water tube

| OEM # | FIG. NO. | PRICE |
|-------|----------|-------|
| 32970 | 34925 | |

**THERE'S NEVER A
MINIMUM ORDER
AT
DUFF!**

**RIDGID Geared Ratchet Lever-Type
Tube Benders**

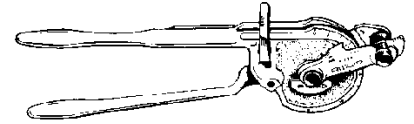

Three Sizes for
5/8", 3/4" and 7/8" O.D. Tube

Geared High Mechanical Ratios Let You Bend: Heavy-Wall Steel Tube (up to 1/8" wall thickness), Stainless Steel Tube (up to 3/32" wall thickness) and Hard Copper Water Tube (types K and L).

Made of high strength aluminum for handling ease, these new RIDGID Ratchet Tube Benders will produce uniform bends up to 180°. Pre-heating of tube or the need of special temper grade tube have been eliminated.

Long ratchet handle and geared 13 to 1 (Model No. 358) and 18 to 1 (Model Nos. 368 and 378) mechanical ratios reduce bending effort to a minimum. Bending roller is free-turning to eliminate friction. Special clamping pad on bottom of form handle allows vise mounting when desired.

| CAPACITY | OEM # | FIG. NO. | PRICE |
|---|-------|----------|-------|
| 5/8" OD tube (1/2" nominal water tube) 3" radius to center line of tube | 35170 | 27601 | |
| 7/8" OD tube (3/4" nominal water tube) 3 3/4" radius to center line of tube | 35180 | 27603 | |

RIDGID Flaring Tools

Mfrs. Code
No. 785461

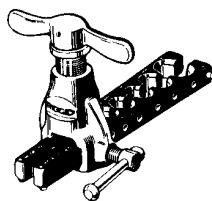

One Integral
Unit . . . Parts
can't get lost

These advanced-design RIDGID Flaring Tools give smooth, uniform flares . . . faster, too . . . with minimum effort, even on large sizes. Large, comfort-grip feed screw handle turns easily. Hardened steel flaring cone, eccentrically mounted in precision bearings, produces rolling action for even metal flow . . . gives uniform flare walls without galling. Flare can then be ironed by continued cone action. Heat treated flaring bars are precision-ground. Tubing hole sizes are clearly marked. Rugged yokes slide to desired size. Yoke clamp screw fits into centering hole . . . locks bars, yoke and tubing into alignment. Stop pins keep yoke on flaring bars at all times.

All Flaring Tools listed immediately below are recommended for soft materials such as aluminum and soft copper. No. 454-W, No. 455 and No. 375 will also flare steel, stainless steel, hard copper and brass. No. 454-W will also flare plastic water tube.

| OEM # | SIZE | TYPE | FIG. NO. | PRICE |
|-------|--------------|-----------|----------|-------|
| 36607 | 1/8 thru 3/4 | 45 DEGREE | 13601 | |
| 41295 | 3/8 thru 1 | 45 DEGREE | 13604 | |

*Nominal Water Tube

RIDGID Flaring Tools

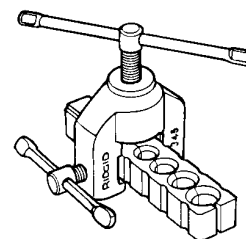

A quality made Flaring Tool that accurately flares 7 sizes: 3/16", 1/4", 5/16", 3/8", 7/16", 1/2" and 5/8" (metric configuration 6, 8, 10, 12, 14, 15, 16mm) O.D. in soft copper, brass, aluminum and mild steel (JIC and Bundy) tubing.

Flares 3/16", 1/4", 5/16", 3/8", 7/16", 1/2" and 5/8" OD tubing, 45 degree.

| OEM # | FIG. NO. | PRICE |
|--|----------|-------|
| 23332 | 27577 | |
| No. 345 with No. 150 tubing cutter and case kit. | | |
| OEM # | FIG. NO. | PRICE |
| 24797 | 34930 | |

**NO ORDER IS TOO SMALL FOR
PROMPT ATTENTION**

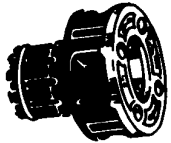

RIDGID DIE HEADS

These complete die-heads are for use with ratchet type die stocks.

DON'T FORGET CUTTING OIL!

COMPLETE 12R STYLE DIE-HEADS WITH DIES

| MODEL NO. | FIG. NO. | SIZE | PRICE |
|-----------|----------|----------------------|-------|
| 37375 | 175366 | 1/8" NPT | |
| 37380 | 17544 | 1/4" NPT | |
| 37385 | 13020 | 3/8" NPT | |
| 37390 | 17538 | 1/2" NPT | |
| 37395 | 13023 | 3/4" NPT | |
| 37400 | 13024 | 1" NPT | |
| 37405 | 13026 | 1 1/4" NPT | |
| 37410 | 13029 | 1 1/2" NPT | |
| 37415 | 13030 | 2" NPT | |
| 38555 | 13058 | 12R ratchet & handle | |

COMPLETE OOR STYLE DIE-HEADS WITH DIES

| | | | |
|-------|-------|----------------------|--|
| 36875 | 12999 | For 1/8" NPT | |
| 36880 | 13000 | For 1/4" NPT | |
| 36885 | 13001 | For 3/8" NPT | |
| 36890 | 13002 | For 1/2" NPT | |
| 36895 | 13004 | For 3/4" NPT | |
| 36900 | 13005 | For 1" NPT | |
| 38540 | 13056 | 00R ratchet & handle | |

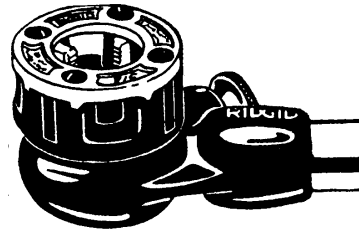

RIDGID DROP HEAD RATCHET THREADER SETS

Unusually handy, efficient drop-head dies. Head locks in or releases by pull of ratchet knob.

Separate sets of alloy steel chaster dies, quickly removed or reversed for close-to-wall threads.

| MODEL # | FIG. NO. | CAPACITY | PRICE |
|---------|----------|--------------|-------|
| 00-R | 34403 | 1/2" thru 1" | |
| 00-R | 24180 | 3/8" thru 1" | |
| 00-R | 34407 | 1/4" thru 1" | |
| 00-R | 34410 | 1/8" thru 1" | |
| 12-R | 12945 | 1" thru 2" | |
| 12-R | 12949 | 1/2" thru 2" | |
| 12-R | 12966 | 1/8" thru 2" | |



RIDGID 3-WAY PIPE THREADER

Handy for threading 3 common sizes of pipe, 1/2", 3/4" and 1" pipe sizes.

| MODEL NO. | FIG. NO. | PRICE |
|-----------|----------|-------|
| 36540 | 12969 | |

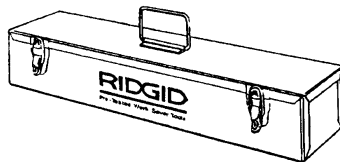

RIDGID METAL CARRYING CASE FOR 12R

Steel case with rust-resistant finish to keep your die sets together.

| FIG. NO. | PRICE |
|----------|-------|
| 47213 | |

OTHER CASES AVAILABLE! PLEASE CALL US AT 610-275-4453

12R STYLE DIES FOR STAINLESS STEEL (fits OOR, 111R, 12R, OR & 11R die heads)

| MODEL NO. | FIG. NO. | SIZE | PRICE |
|-----------|----------|--------|-------|
| 37900 | 13092 | 1/8" | |
| 37905 | 13099 | 1/4" | |
| 37910 | 13100 | 3/8" | |
| 37915 | 13101 | 1/2" | |
| 37920 | 13102 | 3/4" | |
| 37925 | 13103 | 1" | |
| 37930 | 13104 | 1-1/4" | |
| 37935 | 13105 | 1-1/2" | |
| 37940 | 13106 | 2" | |

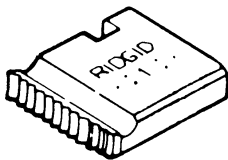

RIDGID PIPE DIES

SEE PAGE 728 FOR CUTTING OIL

| SIZE | 12R STYLE CARBON DIES (Fits OOR, 12R, or & 11R die heads) | | | 12R STYLE HIGH SPEED DIES (Fits OOR, 12R, or & 11R die heads) | | | 12R STYLE PVC DIES (Fits OOR, 12R, or & 11R die heads) | | |
|--------|---|----------|-------|---|----------|-------|--|----------|-------|
| | MODEL NO. | FIG. NO. | PRICE | MODEL NO. | FIG. NO. | PRICE | MODEL NO. | FIG. NO. | PRICE |
| 1/8" | 37810 | 13059 | | 37855 | 13075 | | - | - | |
| 1/4" | 37815 | 13061 | | 37860 | 13076 | | 70680 | 27673 | |
| 3/8" | 37820 | 13063 | | 37865 | 13078 | | 70685 | 27674 | |
| 1/2" | 37825 | 13066 | | 37870 | 13082 | | 70690 | 27675 | |
| 3/4" | 37830 | 13068 | | 37875 | 13083 | | 70695 | 27676 | |
| 1" | 37835 | 13069 | | 37880 | 13085 | | 70700 | 27677 | |
| 1-1/4" | 37840 | 13071 | | 37885 | 13087 | | 70705 | 27678 | |
| 1-1/2" | 37845 | 13072 | | 37890 | 13089 | | 70710 | 27679 | |
| 2" | 37850 | 13073 | | 37895 | 13090 | | 70715 | 27680 | |

RIDGID PIPE DIES

| PIPE DIES | | | |
|------------------------------------|----------|--------------------------------------|-------|
| MODEL NO. | FIG. NO. | DESCRIPTION | PRICE |
| 38100 | 13107 | 65R Dies, 1"-2" HSS | |
| 38105 | 34586 | 65R Dies, HSS for SS | |
| 38120 | 13108 | 141 Dies, 2 1/2-4" HSS | |
| 38155 | 34591 | 161 Dies, 4-6" HSS | |
| 26192 | 34691 | 1224 Mach. Dies 2 1/2-4" | |
| 70640 | 34586 | 141 HSS Dies for SS, 2 1/2-4" | |
| 38125 | 34587 | 141 HSS Dies for Cast Iron, 2 1/2-4" | |
| 70655 | 34592 | 161 HSS Dies for SS, 4-6" | |
| 38160 | 34593 | 161 HSS Dies for Cast Iron, 4;6" | |
| ALLOY UNIVERSAL DIES | | | |
| 47735 | 13190 | 1/8" NPT Dies | |
| 47740 | 13195 | 1/4" - 3/8" NPT Dies | |
| 47745 | 13197 | 1/2" - 3/4" NPT Dies | |
| 47750 | 27563 | 1" - 2" NPT Dies | |
| HIGH SPEED STEEL UNIVERSAL DIES | | | |
| 47755 | 13210 | 1/8" NPT Dies HSS | |
| 47760 | 13212 | 1/4" - 3/8" NPT Dies HSS | |
| 47765 | 13216 | 1/2" - 3/4" NPT Dies HSS | |
| 47770 | 27565 | 1" - 2" NPT Dies HSS | |
| UNIVERSAL DIES FOR STAINLESS STEEL | | | |
| 47775 | 13574 | 1/8" NPT Dies for HSS | |
| 47780 | 13575 | 1/4" - 3/8" NPT Dies for HSS | |
| 47785 | 13576 | 1/2" - 3/4" NPT Dies for HSS | |
| 47790 | 17540 | 1" - 2" NPT Dies for HSS | |
| UNIVERSAL DIES FOR PVC | | | |
| 34908 | 70745 | 1/2" - 3/4" NPT Dies | |
| 88559 | 70750 | 1" - 2" NPT Dies | |

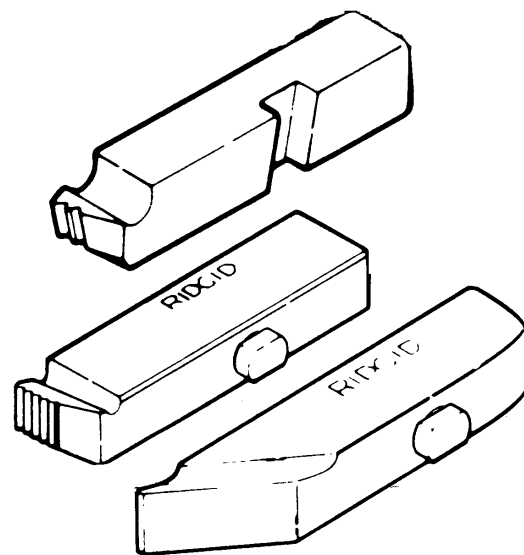

DON'T FORGET CUTTING OIL!

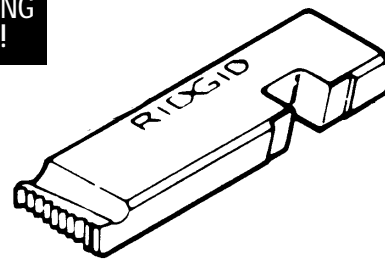

YES!

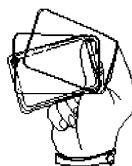

**WE ARE HAPPY TO ACCEPT
VISA AND MASTERCARD!**

PIPE VISES



PORTABLE TRISTAND
CHAIN VISE

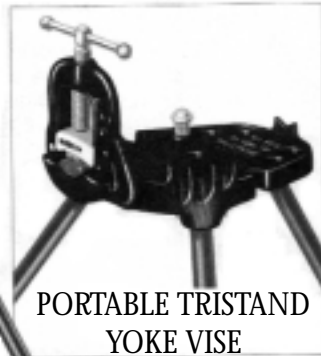

PORTABLE TRISTAND
YOKE VISE

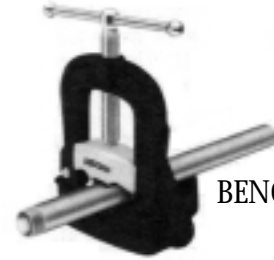

BENCH YOKE VISE



TOP SCREW POST
CHAIN VISE



TOP SCREW STAND
CHAIN VISE



TOP SCREW
BENCH CHAIN
VISE



BOTTOM SCREW
BENCH CHAIN
VISE

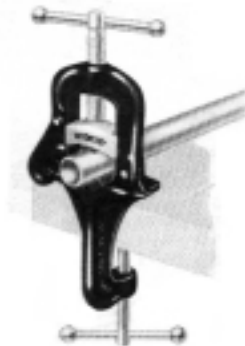

PORTABLE KIT
YOKE VISE
(FITS 4" PLANK)

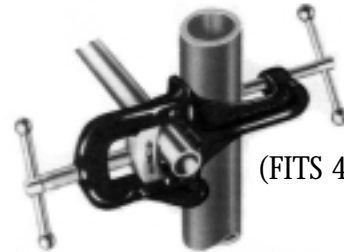

(FITS 4" POST)



FLANGE PIPE
WELDING VISE

PIPE VISES

| FIG. NO. | MODEL NO. | DESCRIPTION | PIPE CAPACITY (IN) | WEIGHT | PRICE |
|----------|-----------|-------------------------------|--------------------|--------|-------|
| 21886 | 40-A | Portable tristan yoke vise | 1/8-2 1/2 | 48 1/2 | |
| 13113 | 450 | Portable tristan chain Vise** | 1/8-5 | 45 1/2 | |
| 34605 | 560 | Top screw stand chain vise | 1/8-5 | 25 3/4 | |
| 13114 | BC210 | Top screw stand chain vise | 1/8-2 1/2 | 7 3/4 | |
| 13115 | BC410 | Top screw bench chain vise | 1/8-4 | 14 3/4 | |
| 27643 | BV210P | Top screw bench chain vise | 1/2-2 7/8OD* | 7 1/2 | |
| 13117 | BC410P | Top screw bench chain vise | 1/2-4 1/2OD* | 14 1/2 | |
| 28175 | BC510 | Top screw bench chain vise | 1/8-5 | 15 | |
| 27645 | BC610 | Top screw bench chain vise | 1/4-6 | 24 1/2 | |
| 27646 | BC810 | Top screw bench chain vise | 1/2-8 | 38 | |
| 34606 | BC2A | Bottom screw bench chain vise | 1/8-2 | 5 3/4 | |
| 34607 | BC4A | Bottom screw bench chain vise | 1/8-4 | 13 | |
| 27715 | 20 | Bench yoke vise | 1/8-1 1/4 | 4 | |
| 27639 | 21 | Bench yoke vise | 1/8-2 | 8 3/4 | |
| 18824 | 22 | Bench yoke vise | 1/8-2 1/2 | 13 | |
| 20239 | 23 | Bench yoke vise | 1/8-3 | 19 3/4 | |
| 27640 | 25 | Bench yoke vise | 1/8-4 | 27 3/4 | |
| 27642 | 27 | Bench yoke vise | 1/8-6 | 65 | |
| 34608 | 640 | Top screw post chain vise | 1/8-5 | 23 1/2 | |
| 34610 | 38 | Portable kit yoke vise | 1/8-2 | 12 | |
| 34611 | 39 | Portable kit yoke vise | 1/8-2 1/2 | 15 1/2 | |
| 34613 | 463 | Elbow pipe welding vise | 2 1/2-8 | 14 | |
| 34614 | 464 | Flange pipe welding vise | 2 1/2-8 | 17 1/4 | |

POWER THREADER



12994

- *Threads 1"-2" pipe
- *True centering workholder
- *Jam-proof
- *Right hand only
- *NPT with 1 set high speed dies



34478

POWER THREADER

- *Threads 1"-2" pipe
- *Jam-proof drive pawl
- *Cam workholder set instantly
- *Right hand only
- *NPT with 1 set high speed dies

| MODEL NO. | FIG. NO. | CAPACITY (INCH) | WGHT (LB) | PRICE |
|-----------|----------|-----------------|-----------|-------|
| 65R-C | 34478 | 1-2 | 25 | |
| 65R-TC | 12994 | 1-2 | 27 | |

GEARED THREADER

- *12996 threads 2 1/2", 3", 3 1/2", 4" pipe with one set of dies
- *34484 threads 4", 4 1/2", 5", 6" pipe with one set of dies
- *Jaw clutch prevents jamming
- *Simple adjustment for tapered or straight threads
- *Cam-type workholder set instantly
- *Fully enclosed gearing
- *Right hand only
- *NPT with 1 set of high speed dies



| MODEL NO. | FIG. NO. | CAPACITY (INCH) | WGHT (LB) | PRICE |
|-----------|----------|-----------------|-----------|-------|
| 141 | 12996 | 2 1/2-4 | 93 | |
| 161 | 34484 | 4-6 | 158 | |

RIDGID HAMMERS



| MODEL NO. | FIG. NO. | DESCRIPTION | HEAD WGT | LENGTH | WGTH | PRICE |
|-----------|----------|--------------------------------|----------|--------|--------|-------|
| 52475 | 27688 | 16 oz. curved claw hammer | 16 oz | 13 1/4 | 1 1/2 | |
| 52480 | 27689 | 20 oz. curved claw hammer | 20 oz | 13 1/4 | 1 3/4 | |
| 52485 | 27690 | 16 oz. ripping claw hammer | 16 oz | 13 1/4 | 1 1/2 | |
| 52490 | 27691 | 20 oz. ripping claw hammer | 20 oz | 13 1/4 | 1 3/4 | |
| 52445 | 27692 | 8 oz. ball pein hammer | 8 oz | 12 | 1 | |
| 52450 | 27693 | 12 oz. ball pein hammer | 12 oz | 13 | 1 1/8 | |
| 52455 | 27694 | 16 oz. ball pein hammer | 16 oz | 14 | 1 1/2 | |
| 52460 | 27695 | 20 oz. ball pein hammer | 20 oz | 14 1/2 | 1 3/4 | |
| 52465 | 27696 | 24 oz. ball pein hammer | 24 oz | 15 1/2 | 2 1/8 | |
| 52470 | 27697 | 32 oz. ball pein hammer | 32 oz | 16 | 2 3/4 | |
| 52495 | 27698 | 2 1/2 lb. short handled sledge | 2 1/2 lb | 15 1/2 | 3 1/4 | |
| 52500 | 27699 | 2 1/2 lb. engineer's hammer | 2 1/2 lb | 15 1/2 | 3 1/4 | |
| 52505 | 88433 | 3 lb. hand drilling hammer | 3 lb | 10 | 3 1/2 | |
| 52510 | 27667 | 6 lb. long handled sledge | 6 lb | 36 | 7 1/2 | |
| 52515 | 27668 | 8 lb. long handled sledge | 8 lb | 36 | 9 1/2 | |
| 52520 | 27669 | 10 lb. long handled sledge | 10 lb | 36 | 11 3/4 | |
| 52525 | 27670 | 12 oz. tinnners' hammer | 12 oz | 12 1/4 | 1 1/4 | |
| 17457 | 27671 | 16 oz. masons' brick hammer | 16 oz | 11 | 1 1/4 | |
| 17462 | 27672 | 3 1/2 half hatchet | 22 oz | 13 | 2 | |

WRENCHES

RIDGID Heavy-Duty Pipe Wrenches

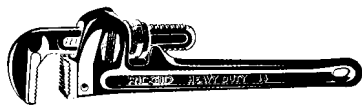

The original heavy-duty pipe wrench, known for its serviceability. Replaceable jaws are made of hardened alloy steel. Full floating hook jaw gives instant grip and release. Handy pipe scale and large easy-to-spin adjusting nut allow fast, one-hand setting to pipe size. Comfort grip, malleable iron I-beam handle.

| OEM # | WRENCH SIZE | CAPACITY | FIG. NO. | PRICE |
|-------|-------------|----------|----------|-------|
| 31000 | 6" | 3/4 | 12774 | |
| 31005 | 8" | 1 | 12778 | |
| 31010 | 10" | 1 1/2 | 12780 | |
| 31015 | 12" | 2 | 12783 | |
| 31020 | 14" | 2 | 12787 | |
| 31025 | 18" | 2 1/2 | 12790 | |
| 31030 | 24" | 3 | 12795 | |
| 31035 | 36" | 5 | 12797 | |
| 31040 | 48" | 6 | 12799 | |
| 31045 | 60" | 8 | 12802 | |

RIDGID Heavy Duty Offset Pipe Wrench



These wrenches are just as strong as regular RIDGID heavy-duty wrenches of the same size. Jaw opening parallels handle making these ideal wrenches for fast, easy, one-hand operation overhead or in tight places. Spring suspended hook jaw gives tight grip, fast release. Narrow jaw head fits into close quarters. Adjusting nut turns easily for fast size adjustment.

| OEM # | WRENCH SIZE | CAPACITY | FIG. NO. | PRICE |
|-------|-------------|---------------|----------|-------|
| 89435 | 14" | 1/8 - 2" | 12832 | |
| 89440 | 18" | 1/4" - 2 1/2" | 12835 | |
| 89445 | 24" | 1/4 - 3" | 12897 | |

RIDGID Aluminum Handle Straight Pipe Wrenches

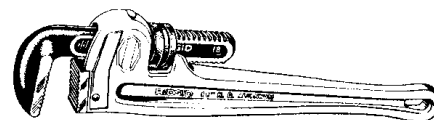

Aluminum handles make these heavy-duty wrenches almost 40% lighter than similar wrenches with malleable iron handles. Parts are identical to those of RIDGID Straight Pipe Wrenches. Ideal for over head work. Also available with special hook and heel jaws for plastic pipe.

| OEM # | WRENCH SIZE | CAPACITY | FIG. NO. | PRICE |
|-------|-------------|----------|----------|-------|
| 31090 | 10 | 1 1/2" | 12898 | |
| 31095 | 14 | 2" | 12900 | |
| 31100 | 18 | 2 1/2" | 12901 | |
| 31105 | 24 | 3" | 12903 | |
| 31110 | 36 | 5" | 12904 | |
| 31115 | 48 | 6" | 12906 | |

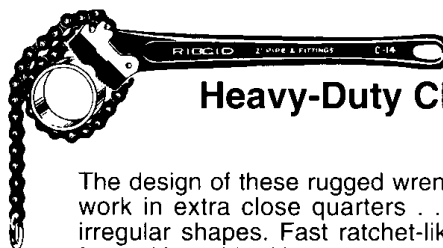

RIDGID Heavy-Duty Chain Wrenches

The design of these rugged wrenches makes it easier to work in extra close quarters . . . on round, square or irregular shapes. Fast ratchet-like action lets you work from either side. Hardened alloy steel jaws are replaceable. Tempered steel chain is held securely in double lock grips, releases quickly.

| OEM # | CHAIN LENGTH | CAPACITY | FIG. NO. | PRICE |
|-------|--------------|----------|----------|-------|
| 31315 | 18 9/16" | 2/5 | 12909 | |
| 31320 | 20 1/4" | 2.5/5 | 12911 | |
| 31325 | 20 1/4" | 3/5 | 12912 | |
| 31330 | 28 7/8" | 4.4/7.5 | 12916 | |

CAPACITY = ACTUAL/RATED

COMBINATION FILL BOX PASS KEY

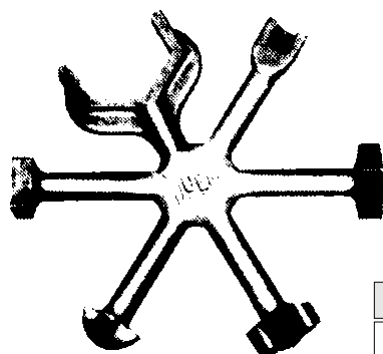

A practical tool of universal use that fits 90% of fill boxes or caps made. Lasting service assured from these strong, malleable iron keys guaranteed not to break.

| FIG. NO. | PRICE |
|----------|-------|
| 17490 | |

For additional information call: 610-275-4453 or Fax: 610-279-6299
Please call for current prices.

FOR WRENCH PARTS, SEE PAGE 667

WRENCHES

RIDGID

Strap Wrenches



For use on polished pipe and tubing - protects nickel and chrome finish. Strong I-beam handle and solid head, all one piece. Handy hang-up hole. Easy to attach and use. Straps are easily replaced . . . easy to use.

| OEM # | CAPACITY | STRAP WXL | FIG. NO. | PRICE |
|-------|----------|--------------|----------|-------|
| 31340 | 1/8 - 2" | 1 1/8-17 | 12918 | |
| 31350 | | 1 1/2-24 | 27498 | |
| 31360 | 1 - 5" | 1 3/4-29 1/4 | 12921 | |
| 31365 | | 1 3/4 - 48 | 27500 | |
| 31370 | 1 - 5.5" | 1 3/4-29 1/4 | 18810 | |

RIDGID

No. E-110 Offset Hex Wrench

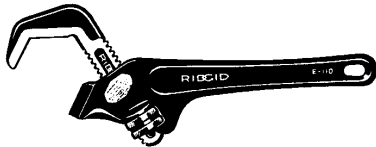

Extra-wide-opening offset jaw gives easy-on, non-slip grip on sink and tube drain nuts . . . all other hard-to-get-at nuts and fittings. Thin, smooth jaws slip into tightest places. Short handle makes work easy in close quarters. Multi-sided grip allows extra leverage.

| | |
|-----------------|----------------|
| OEM # | 31305 |
| MAX JAW OPENING | 2 5/8" |
| NUT CAPACITY | UP THRU 1 1/2" |
| HNDLE LENGTH | 9 1/2" |
| FIG. NO. | 12922 |
| PRICE | |

RIDGID Aluminum Handle

Offset Pipe Wrench



Aluminum Handle Offset Pipe Wrenches featuring a jaw opening parallel to lightweight aluminum handle. These wrenches are almost 50% lighter, but just as strong as regular RIDGID Wrenches of the same size. Housing is replaced free if it ever breaks or distorts. Hook jaw head is narrower to give easy entry into tight spots. Combination of light aluminum handle and forward facing jaw makes overhead or tight quarter work fast and easy. Adjusting nut turns easily for fast size adjustment. Jaws are made of strong alloy steel, then hardened.

| OEM # | WRENCH SIZE | CAPACI- TY | FIG. NO. | PRICE |
|-------|-------------|------------|----------|-------|
| 31120 | 14" | 2" | 38787 | |
| 31125 | 18" | 2 1/2" | 38788 | |
| 31130 | 24" | 3 | 38789 | |

RIDGID

Nos. 1-A & 2-A Heavy-Duty Pipe Cutters

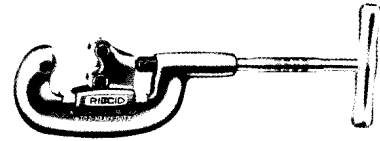

Gives fast, clean pipe cutting by hand or power. Extra long shank protects adjustment threads. Extra large handle for quick, easy adjustment. Balanced frame of special malleable iron. Equipped with tough blade cutter wheel. Can convert to 3-wheel cutter by replacing rollers with cutter wheels.

| OEM # | CAP | FIG. NO. | PRICE |
|-------|-------------|----------|-------|
| 32810 | 1/8 - 1 1/4 | 13119 | |
| 32820 | 1/8 - 2 | 13121 | |

RIDGID

No. 202 Wide-Roll Pipe Cutter

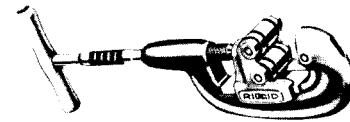

Featuring extra wide rolls, this Heavy-Duty Cutter is especially designed for use with Power Drives. Wide rolls prevent cock or wobble of cutter for perfect tracking, cleaner cuts. Capacity 1/8" through 2".

| OEM # | CAP | FIG. NO. | PRICE |
|-------|---------|----------|-------|
| 32895 | 1/8 - 2 | 20249 | |

RIDGID

Nos 3-S, 4-S & 6-S Heavy-Duty Pipe Cutters



Large handle assures sure grip, easy adjustment. Second handle gives added leverage for large size pipe cutting jobs. Can be converted to 3-wheel cutter by replacing rollers with cutter wheels.

| OEM # | CAP | FIG. NO. | PRICE |
|-------|-------|----------|-------|
| 32830 | 1 - 3 | 17539 | |
| 32840 | 2 - 4 | 13125 | |
| 32850 | 4 - 6 | 13127 | |

FOR REPLACEMENT STRAPS,
CUTTER WHEELS AND WRENCH
PARTS, SEE PAGE 667

RIDGID TOOLS

RIDGID

No. 2-S Spiral Ratchet Pipe Reamer

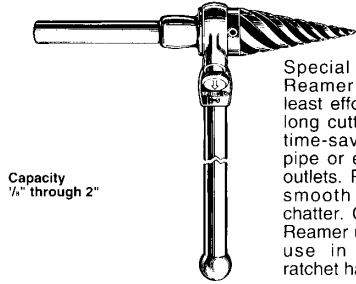

Capacity
1/4" through 2"

Special spiral design of 2-S Reamer cuts into metal with least effort — fast, clean cuts, long cutting life. Makes easy, time-saving work of reaming pipe or enlarging conduit box outlets. Reams sheet metal — smooth and easy without chatter. Complete with handle. Reamer unit available alone for use in RIDGID No. 00-R ratchet handle.

| OEM # | DESCR | FIG. NO. | PRICE |
|-------|----------|----------|-------|
| 34955 | complete | 13141 | |

RIDGID Pipe Welding Vises

Four Models Align and Hold Pipe for Straight, Elbow, Flange or Angle Track Welding.

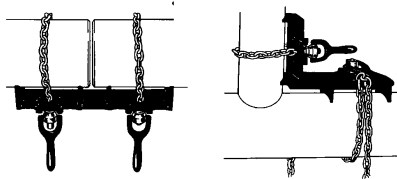

No. 461 Straight Pipe Welding Vise — Used on mains and risers for aligning and holding the pipe which is to be tacked. Holds pipe from 1/2" through 8".

No. 462 Angle Pipe Welding Vise — Used on headers, drips and branches up through 12". Holds branch line at right angle to main or header for layout and cutting.

| OEM # | FIG. NO. | PRICE |
|----------------|----------|-------|
| 461 (Straight) | 13118 | |
| 462 (Angle) | 34612 | |

RIDGID No. 318 Oiler

Stops Oil Waste, Keeps Dies Flooded for Perfect Threads, Longer Die Life!

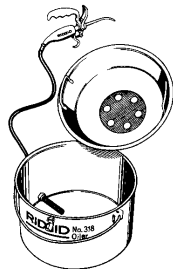

Hand-operated continuous oiler pumps easily by thumb action. Large chip pan catches oil runoff, chips and scraps. No messy floors. Oil is double-screened and recirculated through reservoir, hose and hand pump. Completely portable. Quickly pays for itself in oil savings alone. Chip pan is 14 1/2" in diameter, 8 1/2" high. Hose length, 48".

Mfrs. Code No. 785461

| OEM # | FIG. NO. | PRICE |
|-------|----------|-------|
| 41650 | 13138 | |

RIDGID

4-Wheel Pipe Cutters

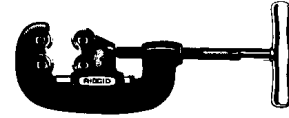

These 4-wheel cutters are designed for work in areas where a complete turn is impossible. No. 42-A has short handle for use in extra-tight places where only a quarter turn can be made. Second handle on No. 44-S makes 2-man leverage possible on large pipe sizes. Both are equipped with 4 Heavy-Duty Wheels.

| OEM # | CAP | FIG. NO. | PRICE |
|-------|---------|----------|-------|
| 32870 | 3/4 - 2 | 27588 | |

RIDGID No. 700 Portable Power Drive

Threading Capacity:
1/4" through 2" pipe and conduit
1/4" through 1" rod

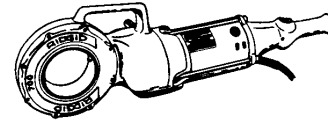

Heavy-Duty Power for Threading and Driving Geared Threaders

The RIDGID No. 700 Power Drive is compact, powerful, engineered and built for complete utility and trouble-free service. Plenty of power to cut threads and drive geared threaders. Reversible motor and all-spur gear reduction assure maximum power and efficiency. Die heads and adapters lock in securely from either side. RIDGID No. 12-R Die Heads fit without an adapter while only four adapters are needed for other RIDGID Die Heads. A Square Drive Adapter is used for RIDGID Geared Threaders. Gear case, housing and handle are rugged cast aluminum for strength without added weight. Motor: Universal, 1/2 hp, 115 or 230 volt, ac (25-60 Hz), reversible, 3 pole, double throw (reversible) switch with spring return to center "off" position.

| DESCRIPTION | OEM # | FIG NO | PRICE |
|-------------------------------------|-------|--------|-------|
| Portable Power Drive | 41935 | 13147 | |
| Adapter for 00-R and 00-RBDie Heads | 42600 | 13151 | |
| Adapter for 11-R die head | 42610 | 34628 | |
| Adapter for 111-R die head | 42615 | 34629 | |
| Square Drive Adapter | 42620 | 34630 | |
| Carrying case for 700 series | 42950 | 34632 | |

RIDGID No. 775 Support Arm for 700 Power Drive



No. 775 Support Arm improves overall thread cutting operation of the No. 700. No. 775 provides the guide for straight threads and eliminates possibility of damage to spline end of die head by keeping power drive square to pipe. By taking torque and being clamped securely onto pipe or conduit, the Support Arm also contributes to a safer threading operation.

| OEM # | FIG. NO. | PRICE |
|-------|----------|-------|
| 42625 | 34631 | |



For additional information call: 610-275-4453 or Fax: 610-279-6299
Please call for current prices.

RIDGID MACHINES

RIDGID No. 535 Pipe & Bolt

Threading Machine

Capacity 1/4" thru 2" Pipe;
1/4" thru 2" Bolts

Ideal for bench or stand mounting. It threads, cuts and reams . . . even cuts close nipples when you use a No. 819 Nipple Chuck. Popular Speed Chuck sets and releases by hand . . . holds tight, forward or reverse. 3-jaw rear centering device centers long lengths for true threads and cuts. Integral foot switch provides safer operation. Pipe can be chucked from front. All tools operate independently, swing up out of way when not in use. Lathe-type adjusting handle moves carriage accurately, smoothly. Easy-to-read length gauge gives fast, exact cutoffs. Reversible vane-type pump recirculates and cleans thread cutting oil. 1/2 h.p. single phase 115 volt, AC, 25-60 cycle Universal motor is reversible at switch. 230 volt motor available. All RIDGID quick-opening Pipe and Bolt Machine Die Heads and Dies can be used.

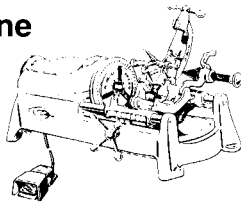

Machine with standard equipment cutter, reamer, 1 gallon RIDGID nuclear thread cutting oil, 4 hex keys, 1 spare cutter wheel and lubricating grease, but LESS all die heads and dies. No. 820 wheel-type cut-off.

| OEM # | FIG. NO. | PRICE |
|-------|----------|-------|
| 41915 | 34713 | |

RIDGID No. 1224 Pipe & Bolt

Threading Machine

Capacity 1/4" thru 4" pipe
1/4" thru 2" bolts

The RIDGID No. 1224 Threading Machine is designed to thread 1/4" through 4" pipe and conduit, 1/4" through 2" rod (bolt stock). Speed Chuck sets and releases by hand . . . holds tight, forward or reverse. 3-jaw rear centering device centers long lengths for true threads and cuts. Integral foot switch provides safer operation. All existing RIDGID universal and 500B dies can be used with the No. 1224 Threading Machine. 2 1/2" - 4" receding die head is able to cut tapered or straight threads (NPT or NPSM/BSPT or BSPP) with no change of dies or accessories. The die head is fully automatic with one hand operation. 1 1/2 H.P. single phase, 115V, 60 Hz or 50 Hz induction type motor. Cuts close nipples with No. 819 Nipple Chuck.

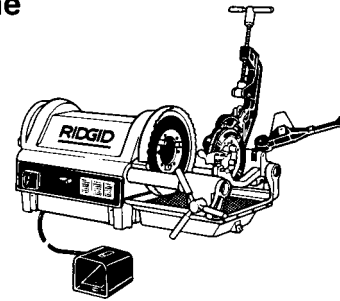

Includes standard equipment (cutter, reamer, 1 gallon RIDGID thread cutting oil, 4 hex keys, spare cutter wheel, 3/4" combination wrench, tool box and lubricating grease), but LESS all die heads and dies. No. 764 wheel-type cut-off.

| OEM # | FIG. NO. | PRICE |
|-------|----------|-------|
| 26092 | 34680 | |

RIDGID



NO. 206 PIPE CUTTER

Cuts 2"-6" No Hub soil pipe. Lighter weight and closer spacing of cutter wheels, together with simple ratcheting action, give smooth cut on lighter wallpipe. Ratchet-action handle parallels pipe so trench can be minimum width. Complete with hand guard to protect operator's knuckles at time of cut.

| OEM # | FIG. NO. | PRICE |
|-------|----------|-------|
| 68650 | 27562 | |

RIDGID No. 246 Soil Pipe Cutter

Lightest, Most Compact, Most Powerful in its 2" through 6" Size Range

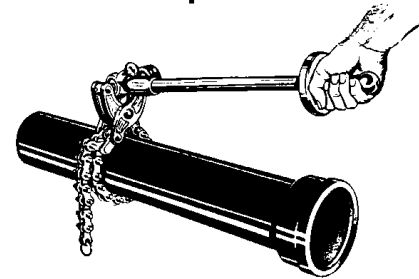

High mechanical advantage gives this light (24 lbs.), compact cutter plenty of power to cut all 2" thru 6" clay, cast iron, asbestos, cement pipe and through Class 22, 4" water main. One man handles it in tightest quarters. Since ratchet action parallels pipe, pipe becomes second lever and helper as well. A few easy pumps of handle tighten chain until pipe is severed. Hand guard protects operator's knuckles at time of cut. Made of all alloy, heat-treated steel, all parts are plated or painted . . . will not corrode. Threaded parts are sealed to keep dirt and moisture out . . . lubrication in.

| OEM # | FIG. NO. | PRICE |
|-------|----------|-------|
| 32900 | 13133 | |

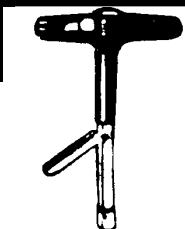

| OEM # | FIG. NO. | PRICE |
|-------|----------|-------|
| 31410 | 13134 | |

RIDGID THREADING MACHINES

RIDGID MODEL 1210 1" OIL-LESS THREADING MACHINE

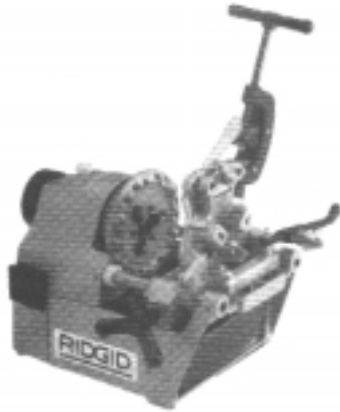

The model 1210 is the world's first completely oil-less threading machine! No more worrying about oil spills and drips, no more setting up away from the installation site - with eh 1210 you can thread right where you install: in basements, on rooftops, even in finished rooms! To eliminate cutting oil, the Model 1210 combines specially formulated RIDGID thread cutting coolant and unique RIDGID oil-less gold dies. RIDGID thread cutting coolant will evaporate on contact with the pipe and leave you with a clean, cool, dry thread ready for immediate installation!

- CAPACITY: 1/2", 3/4", 1" pipe
- WEIGHT: 59 lbs.
- MOTOR: 1/2 hp, 115v Universal 50-60 Hz
- MOTOR CONTROL: Heavy-duty toggle on/off with integral foot switch
- SPINDLE SPEED: 25 rpm
- CHUCK: Hammer-type with replaceable inserts; cam action rear chuck
- COOLANT SYSTEM: Through-the-head with integral coolant reservoir; self-priming gerotor pump; 16 oz. capacity.

STANDARD EQUIPMENT

- Model 610 quick-open die head
- Model 334 reamer
- Model 354 cutter
- Set, 1/2"-3/4" oil-less gold dies
- Set, 1" oil-less gold dies
- Quart, thread cutting coolant

| DESCR | FIG. NO. | PRICE |
|-----------------------|----------|-------|
| 1210 1/2"-1" machine | 85045 | |
| 1/2" - 3/4" gold dies | 85047 | |
| 1" gold dies | 85048 | |
| 610 die head | 85049 | |
| 120 folding stand | 85050 | |
| 1 qt. coolant | 85051 | |

RIDGID MODEL 300 COMPACT THREADING MACHINE

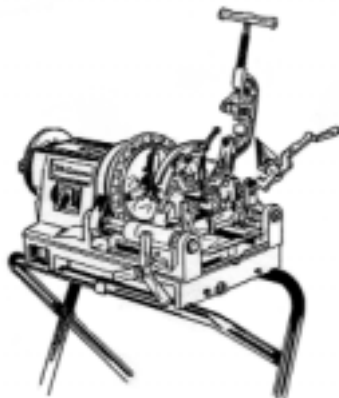

The most powerful and portable 2" machine available today. Features include: folding stand and oil seal for easy transport; self-contained oil system with through-the-die-head oiling; easy clip for footswitch, optional adapter to mount 916 groover; quiet operation with 1/2 HP 115 v motor producing 38 rpm.

- CAPACITY: Pipe 1/8"-2"; bolt 1/4" - 2"

STANDARD EQUIPMENT

- 1/8"-2" universal die head
- 1 - 360 Cutter with E-1032 cutter wheel
- 1 - 344 Cone-type reamer
- 1 - Set of 1/2" - 3/4" alloy universal dies
- 1 - Set of 1" - 2" alloy universal dies
- 1 - Gallon Nu-Clear thread cutting oil

| DESCR | FIG. NO. | PRICE |
|-------------------------|----------|-------|
| 300 Compact w/ stand | 85446 | |
| 815A SO Univ Head | 34638 | |
| 811A QO Univ Head | 19495 | |
| 531 1/4"-1" Bolt Head | 34888 | |
| 532 1-1/4"-2" Bolt Head | 34890 | |
| 916 Groover Bracket | 76200 | |
| Nipple Chuck, 1/2"-2" | 13179 | |

RIDGID

RIDGID Accessories

for No. 300
Power Drive

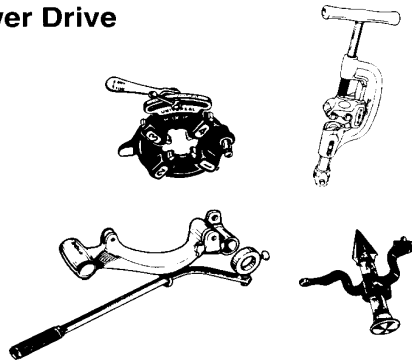

RIDGID No. 811A Quick-Opening Die Heads or No. 815A Self-Opening Die Head.

RIDGID Universal Quick-Opening Die Head or No. 815 Self-Opening Die Head snap-locks into carriage quickly, easily . . . eliminates slow back-off. Single adjustment on carriage centers die heads for true threads.

| OEM # | FIG. NO. | DESCR | PRICE |
|-------|----------|--------------------------------------|-------|
| 97065 | 19495 | Pipe - 1/8" - 2" Bolt - 1/4" - 2" | |
| 97075 | 34638 | Pipe - 1/8" - 2" Bolt - 1/4" - 2" | |

RIDGID No. 311 Carriage with Lever for No. 300 Power Drive

Slip this strong carriage on your RIDGID 300 Power Drive, with 2 support bars, and you'll get fast cut-and-thread efficiency. Holds die head, cutter and reamer at your fingertips exactly like a Pipe Machine. No tools to drop. Easy sliding . . . snugs right up to chuck for close threading and cut-off. Die head and cutter operate independently . . . swings up and stays out of way when not in use. Add a RIDGID No. 819 Nipple Chuck, and you can thread close nipples.

| OEM # | FIG. NO. | PRICE |
|-------|----------|-------|
| 68815 | 34636 | |

RIDGID No. 360 Cutter

1/8" through 2" Pipe, 1/8" through 1/2". Rod with No. 1 & 2 Wheels, 1/8" through 1" Rod with E-1032 Cutter Wheel

Full-floating, wheel-type cutter . . . wide rolls for straight cuts at Pipe Machine speed. Attaches easily with swivel drive pin. Fits 311 Carriage.

| OEM # | FIG. NO. | PRICE |
|-------|----------|-------|
| 42370 | 13170 | |

RIDGID No. 341 Reamer

This rugged reamer smooths inside edges of pipe fast and easy with five-flute cone. Handles all 1/8" through 2" pipe or conduit. Short length permits reaming of "close" nipples. Fits 311 Carriage.

| OEM # | FIG. NO. | PRICE |
|-------|----------|-------|
| 42365 | 13167 | |

RIDGID No. 312 Carriage Lever

RIDGID No. 312 Carriage Lever gives fast, easy positioning of die head, cutter or reamer . . . increases leverage for quicker threading and reaming

| OEM # | FIG. NO. | PRICE |
|-------|----------|-------|
| 42385 | 34637 | |

RIDGID No. 300 Power Drive

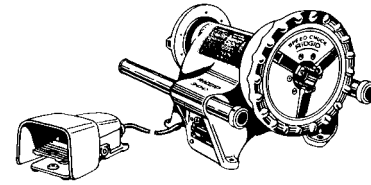

Lightweight • Heavy-Duty Full 2" Capacity • All-Metal Construction

Ideal for bench, truck or stand mounting. RIDGID Speed Chuck holds tight, forward or reverse . . . integral foot switch for safer operation . . . replaceable jaw inserts . . . all-metal, one-piece hand wheel . . . 2 tool support bars . . . 1/2 h.p. 115 V. Universal, reversible motor. 230 V. motor available at no extra cost. 3-jaw, cam-action, rear centering device keeps pipe straight for true threads and cuts. Capacity 1/8" thru 2" pipe and conduit, 1/4" thru 2" bolts and rod, also plenty of power for geared tools.

| OEM # | FIG. NO. | PRICE |
|-------|----------|-------|
| 41855 | 34671 | |

RIDGID No. 1206 Stand for No. 300 Power Drive

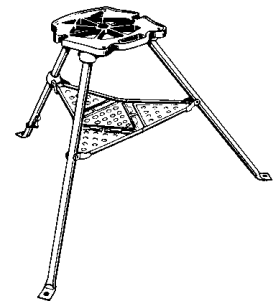

When you take your RIDGID 300 Power Drive out on the job, here's just what you'll need for easy portability and time-saving work base. Integral folding legs and tray are extra rigid when opened for use . . . fold and chain lock closed for easy carrying . . . no loose parts.

| OEM # | FIG. NO. | PRICE |
|-------|----------|-------|
| 42360 | 13164 | |

RIDGID No. 916 Roll Groover

RIDGID Model 916 Roll Groover is the most durable and mechanically efficient lightweight portable unit available. built with a solid, durable cast-iron housing, it can withstand heavy usage, but is light enough for easy transportation on the job site. The 916 features a unique feed mechanism that is quick and efficient allowing for effortless and accurate operation.

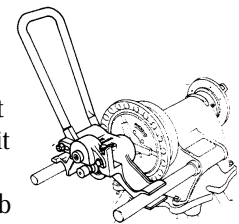

| OEM # | FIG. NO. | PRICE |
|-------|----------|-------|
| 45007 | 76200 | |

RIDGID PARTS

WRENCH PARTS

| STR | END | IRON HANDLE STRGHT WRENCH | PRICE | IRON HANDLE END WRENCH | PRICE | ALUM HANDLE STRGHT WRENCH | PRICE | NUT | PRICE | JAW PIN | PRICE | HEEL JAW & PIN ASSEM-BLY | PRICE | COIL & FLAT SPRING ASSEM-BLY | PRICE | HOOK JAW | PRICE |
|-----|-------------|---------------------------|-------|------------------------|-------|---------------------------|-------|-------|-------|---------|-------|--------------------------|-------|------------------------------|-------|----------|-------|
| 6 | E-6 | - | | 34356 | | - | | 12706 | | 34370 | | 17524 | | 12767 | | 12873 | |
| 8 | E-8 | 34346 | | 34357 | | - | | 12707 | | 34371 | | 12724 | | 17527 | | 12876 | |
| 10 | E-10 | 34347 | | 34358 | | 34364 | | 12709 | | 34372 | | 17525 | | 12849 | | 12882 | |
| 12 | E-12 | 34348 | | 34359 | | - | | 12710 | | 34373 | | 12730 | | 17528 | | 12885 | |
| 14 | E-14 | 34349 | | 34360 | | 34365 | | 12711 | | 34373 | | 12730 | | 12855 | | 12887 | |
| 18 | E-18 | 34350 | | 34361 | | 34366 | | 12713 | | 34374 | | 12744 | | 17529 | | 12888 | |
| 24 | E-24 | 34351 | | 34362 | | 34367 | | 12715 | | 34375 | | 12749 | | 12862 | | 12890 | |
| 36 | E-36 | 34352 | | 34363 | | 34368 | | 12717 | | 34376 | | 12758 | | 12865 | | 12891 | |
| 48 | - | 34353 | | - | | 34369 | | 12719 | | 34377 | | 12760 | | 12868 | | 12893 | |
| 60 | - | 34354 | | - | | - | | 12720 | | 34378 | | 17526 | | 12871 | | 12894 | |
| 10" | Wrap Wrench | 34355 | | - | | - | | 12709 | | 34372 | | 17525 | | 12849 | | 12882 | |

RIDGID Pipe Cutter Wheels

Mfrs. Code No. 785461



Wheel For Cast Iron Pipe



Standard Thin Wheel



Heavy-Duty Wheel

| OEM # | TYPE | FOR RIDGID PIPE CUT-TER NO'S | FIG.NO. | PRICE |
|-------|--------|--|---------|-------|
| 44185 | | 360, 820 | 13677 | |
| 44190 | 1032SS | 360, 820 | 13680 | |
| 83140 | R83140 | 466C, 466S, 477HWS, 468C, 468S, 468HWS, 472C, 472S, 472HWS | 28674 | |
| 33110 | F514 | 1A, 2A, 42A, 202, 360, 820 | 13697 | |
| 33120 | F515 | 3S, 4S, 44S, 466C, 466S, 466HWS, 468C, 468S, 468HWS, 472C, 472S, 472HWS | 13700 | |
| 33105 | F3 | 1A, 2A, 2, 42A, 202, 360, 820 | 13686 | |
| 33125 | F229 | 3S, 4S, 44S, 466C, 466S, 466HWS, 468C, 468S, 468HWS, 472C, 472S, 472HWS | 13691 | |
| 33145 | F367 | 6S, 208, 209 | 13695 | |
| 33115 | F119 | 1A, 2A, 42A, 202, 360, 820 | 28675 | |
| 33135 | E1962 | 3S, 4S, 44S, 466C, 466S, 466HWS, 468C, 468S, 468HWS, 472C, 472S, 472HWS | 28673 | |
| 33155 | F383 | 6S, 208 | 28677 | |
| 33220 | E109 | 206 | 13675 | |
| 33225 | E2632 | 246 | 13684 | |
| 33110 | F35SS | 1A, 2A, 42A, 202, 360, 820 | 13687 | |
| 33130 | F229S | 3S., 4S, 44S, 466C, 466S, 466HWS, 468C, 468S, 468HWS, 472C, 472S, 472HWS | 13693 | |
| 33150 | F367S | 6S, 208, 209 | 13696 | |

REPLACEMENT STRAPS

| STRAP WIDTH INCHES | STRAP WIDTH MM | FIG. NO. | PRICE |
|--------------------|----------------|----------|-------|
| 1/2 | 12 | 34381 | |
| 1 1/8 | 30 | 30499 | |
| 1 1/8 | 30 | 34382 | |
| 1 1/8 | 30 | 34383 | |
| 1 3/4 | 45 | 22976 | |
| 1 3/4 | 45 | 34384 | |
| 1 1/16 | 27 | 34385 | |
| 1 3/4 | 45 | 34386 | |

SEE PAGE 662 FOR COMPLETE STRAP WRENCH

FAX YOUR ORDER TODAY!

610-279-6299

RIDGID REFRIGERANT RECOVERY SYSTEMS

RIDGID SystemSafe Leak Detection

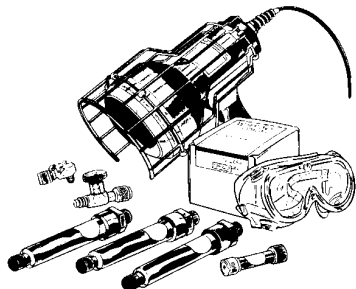

SystemSafe leak detection equipment consists of three components:

- A high-intensity, ultraviolet lamp
- Specially developed, fluorescent formulas
- A formula injector or formula capsules

The special formula is injected into the AC/R system suspected of containing leaks. There, the formula mixes with the refrigerant and compressor oil in the system. As small amounts of refrigerant leak, the formula also leaks out. Using the ultraviolet lamp to inspect solder joints, fittings, couplings and shaft seals, you will be able to quickly pinpoint the exact source of every leak. The source of each leak is marked by the bright, fluorescent, yellow-green glow of the formula, which remains at the leak's source.

Formula injectors.

Injectors for use with bottles of SystemSafe formula are available in three sizes, holding from 1/2 to 2 oz. of SystemSafe formula. Larger sizes are available on special order. Each injector's unique, transparent housing and two control valves permit excellent control of the injection rate. This prevents the compressor from slugging and assures that atmospheric contamination (air and moisture) will not be introduced into the system.

Formula capsules.

Formula capsules are pre-filled, pre-measured, disposable capsules of SystemSafe formula. These capsules are attached directly to the charging hoses, eliminating the need to fill the formula injector, saving time and effort.

Fluorescent Leak Detection Kit Includes:

- *Model UVL-150, 150W UV Lamp, 115V
- *Formula Injector
- *UV Goggles
- *Quick Disconnect Adapter
- *Carrying Case
- *Four 1/2 oz. bottles of each: System Safe 1, 2, & 3

| OEM# | WT. LBS. | FIG. NO. | PRICE |
|----------|----------|----------|-------|
| RLD-1000 | 16 1/4 | 48661 | |

Fluorescent Leak Detection Kit Includes:

- *Model UVL-150, 150W UV Lamp, 115V
- *CV-5 Control Valves
- *UV Goggles
- *Quick Disconnect Adapter
- *Carrying Case
- *Two capsules each of: System Safe 1 & 2, one of each: System Safe 101 & 3

| OEM# | WT. LBS. | FIG. NO. | PRICE |
|----------|----------|----------|-------|
| RLD-1100 | 15 | 48691 | |

RIDGID SystemSafe Refrigerant Recovery

SystemSafe RS-200

The RS-200 utilizes a patented technology that enables it to recover refrigerants up to three times faster than conventional equipment. The patented "Tank Precooling" technology quickly draws deep vacuums without the problems usually experienced when recovery tanks overheat. The same technology that makes the RS-200 very fast makes it extremely versatile and easy to operate. Both liquid and vapors can be recovered at a flip of a switch and with no hose changes. A wide range of refrigerants, including CFC, HCFC, HFC and blended refrigerants, can be recovered with the same machine.

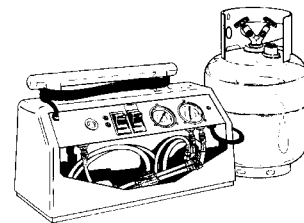

Refrigerant Recovery Unit:

- *1/3 HP
- *115V
- *5.8 Amps
- *Includes: Refrigerant Storage Tank with insulating jacket and refrigerant charging hoses.

| OEM# | WT. LBS. | FIG. NO. | PRICE |
|--------|----------|----------|-------|
| RS-200 | 53 | D54657 | |

Refrigerant Recovery Tank:

- *Refrigerant storage tank with insulating jacket and 80% tank full safety shutoff.
- *Capacity: 50 LBS

| OEM# | WT. LBS. | FIG. NO. | PRICE |
|------|----------|----------|-------|
| T-50 | 25 | D54662 | |

PRESSURE PUMP

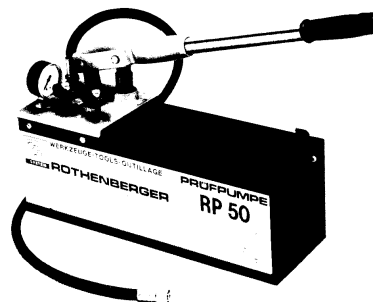

Hydrostatic Pressure Pump

- Ideal for system filling or pressure-only test of water and oil systems
- Simple and efficient to use—complete with high pressure hose and connectors
- Easy adjusting needle valves assure continuous operation for testing and bleeding
- High grade steel pump and polymid piston assure strength and safety
- Specifications—
Maximum pressure—700 lbs. (p.s.i.) Hose connection—1/2" NPT
Tank capacity—3 gallons Tank size—28 3/4" x 6 1/2" x 10 1/2"

| FIG. NO. | PRICE |
|----------|-------|
| 51051 | |

RIDGID MISCELLANEOUS TOOLS

RIDGID No. 1202

Universal Saw

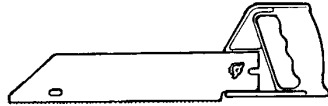

Ideal for clean, accurate cutting of plastic pipe, laminates, plywood and veneers. Tough, polished steel, 14 TPI (12^{1/2}" blade). Comfort-grip plastic handle. Doubles as excellent miter box saw. Special toothing on curved back edge cuts slots.

| OEM # | FIG. NO. | PRICE |
|-------|----------|-------|
| 35990 | 13637 | |

RIDGID No. 1203 Jab Saw

Mfrs. Code No. 785461



This rugged saw is extra handy for those hard to get at sawing jobs. Handle is rugged aluminum casting. Backbone and clamping insert are tempered steel. The saw comes equipped with a RIDGID No. 1024-A Hack Saw Blade. However, any make or size, even broken blades, can be used depending on the cutting job.

Blade can be used extended for deep cuts. Or, it can be extended and flexed for cuts flush to any surface.

| OEM # | FIG. NO. | PRICE |
|-------|----------|-------|
| 35995 | 19058 | |

RIDGID

Automatic Locking Steel Tapes

Mfrs. Code No. 785461

Blade Locks Where You Want It, Rewinds Automatically

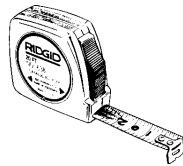

Chromium plated inside-outside case has button control for locking and power rewinding of tape. Removable belt clip. Tempered steel blade is finished in white enamel and coated with Mylar® for lasting protection. Self-adjusting inside-outside end hook. Stud marks every 16 inches. Replaceable blade. No. 665 is Metric/English with millimeters on upper edge of blade and inches on lower edge.

| OEM # | Width | Length | Fig. No. | Price |
|-------|-------|--------|----------|-------|
| 36040 | 3/4" | 12' | 13630 | |
| 80295 | 3/4" | 20' | 27528 | |
| 90260 | 3/4" | 25' | 13632 | |

RIDGID Steel Tapes



Durable case has vinyl covering over rust-resistant coated steel liner. All fittings are nickel plated. Fold-in-rewind handle is opened easily by push pin. Easy-to-read white steel tape shows inches in black, feet in red. 16" centers are clearly indicated. Replaceable mar-resistant tapes have triple baked finish on bonderized steel. Smooth surface is easy to clean. Folding end hook holds firmly yet is easily released. Refills available.

| OEM # | Width | Length | Fig. No. | Price |
|-------|-------|--------|----------|-------|
| 36055 | 3/8" | 100' | 27530 | |

RIDGID Cold Chisels and Chisel Sets

Made from chrome alloy steel. Heat treated and drawn to insure maximum durability at the working end and maximum impact resistance at the striking end. Shank is square for easy gripping and prevents tools from rolling off work area. Nickel chrome plated for corrosion resistance.

| OEM # | FIG. NO. | PRICE |
|-------|----------|-------|
| 31592 | 35073 | |

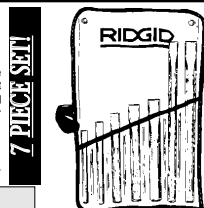

RIDGID Shovels



Professional Quality, Precision-Built For Long Hard Service

Super-strong, light weight, extra-durable. Shovel blades and shanks are one-piece, rust-proofed, 16 gauge steel, taper forged, then heat treated. Round blades have slip resistant, turned step. Handles are burnished, lacquered ash, double riveted to blade socket.

| DESCR | OEM # | FIG. NO. | PRICE |
|-----------------------|-------|----------|-------|
| Lg Hndle Rd Pt Shovel | 52300 | 22855 | |
| Lg Hndle Sq Pt Shovel | 52305 | 27684 | |
| D Hndle Rd Pt Shovel | 52310 | 13638 | |
| D Hndle Sq Pt Shovel | 52315 | 27685 | |
| D Hndle Drain Spade | 52320 | 13639 | |
| D Handle Scoop Shovel | 88680 | 27687 | |

RIDGID Fiberglass Folding Rules

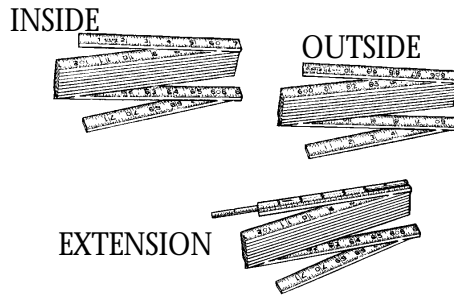

Extremely flexible, rugged construction. Designed for years of accurate service.

Precision-made of durable, heavy duty fiberglass. Have easy-to-read, embedded, bold face figures and graduations. Red 16" stud marks. Easy-action positive locking joints. All rules 5/8" wide.

| OEM # | Descr | Width | Length | Fig. No. | Price |
|-------|---------|-------|--------|----------|-------|
| 73365 | Outside | 5/8" | 6' | 13628 | |
| 73370 | Inside | 5/8" | 6' | 27518 | |
| 73360 | Ext | 5/8" | 6' | 13629 | |

For additional information call: 610-275-4453 or Fax: 610-279-6299

Please call for current prices.

FREEZE KITS FOR PIPE AND TUBE REPAIR



RoFrost CO2 Freeze Kits - For tubing repair - Freezes lines from 1/8 pipe to 2" pipe. 1/2" Copper to 2 1/2" Copper. 10 sizes of freeze heads. Use with CO2 cylinder. **Environmentally safe!**

| FIG. NO. | PRICE |
|----------|-------|
| 16308 | |

FREEZE KITS

Self-contained refrigeration unit that freezes steel pipe up to 1" and copper tube up to 1 1/2". Draining complete water systems or using old valves is no longer necessary - simply isolate the section need to repair using the SuperFreeze pipe-freeze tool and perform you work while the unit continues to operate.

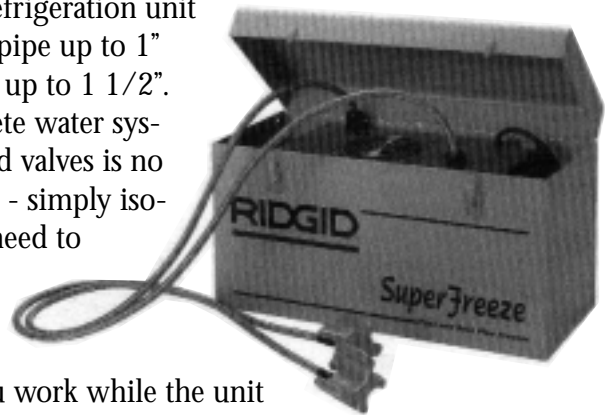

Capacity: Steel pipe 1/2", 3/4", 1"
 Compressor: 110v
 Refrigerant: R-22 (13 oz. charge)
 Weight: 42 lbs.
 Hose Length: 6 ft. (12 ft. span)
 Dimensions: L=19.5" W=8.5" H=13"

| FIG. NO. | PRICE |
|----------|-------|
| 67209 | |

FOR PIPE REPAIRS
 ALSO SEE
 PAGE 41
 FOR ADD-A-VALVE
 SEE REPAIR CLAMPS
 ON
 PAGE 65 THROUGH 68
 AND EPOXYS
 ON
 PAGE 715

**POWER WRAP
 Industrial Strength**

Pipe, Hose and Specialty Application
REPAIR KIT

Industrial Strength
 Water-Activated Fiberglass Tape
 Pressure Tested @ 300+ PSI

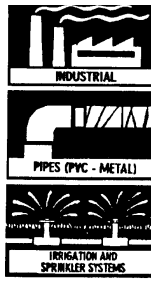

Repair almost any surface:
 PVC, Copper, Galvanized Clay Pipe, Metals, Rubber, Wood, Pumps,
 Plumbing, Valves, Fiberglass, Automotive, Pools & Spas

| DESCR | FIG. NO. | PRICE |
|----------|----------|-------|
| 3" X108" | 43676 | |



FLOOD GUARD operates like a check valve to seal off water back-up caused by overloaded sewers. Water flows normally through the drain until the sewer begins to back up. Then the FLOOD GUARD float rises to seal off the drain opening until the water recedes.

A screwdriver and a couple of minutes are all you need to install a FLOOD GUARD. Once in place, it can prevent property damage and a very messy clean-up job.

Gaskets are made of molded rubber, and all metal parts are plated, except for screws and float rod, which are solid brass.

| FIG. NO. | SIZE | PRICE |
|----------|------|-------|
| 15346 | 2" | |
| 15347 | 3" | |
| 15348 | 4" | |

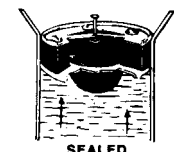
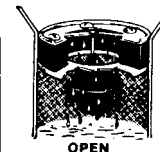

For additional information call: 610-275-4453 or Fax: 610-279-6299.
 Please call for current prices.

MISCELLANEOUS TOOLS

DUTCH FINGER VALVE TOOLS

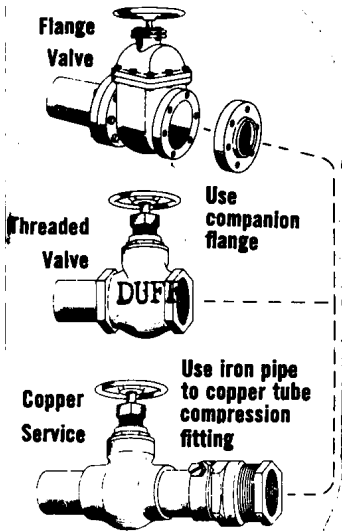

Use on all types of full flow valves — threaded, flanged or copper service...



“A” SERIES VALVE TOOLS

Popular for work on low to medium pressures in sizes up to 3". Cadmium plated carbon steel construction. Expanded seal holds sealing element in pipe. Gland seals of same material as ordered for Main seal.

“A” SERIES - SPECIFICATIONS AND PRICES.

COMPLETE SET OF “A” SERIES INCLUDE 1 TOOL OF EACH SIZE.

| MODEL # | SIZE | RATED PRES-SURE | ASSEMBLY TUBE | LENGTH | FIG. NO. | PRICE |
|---------|-------|-----------------|---------------|--------|----------|-------|
| A1 | 1/2 | 200 PSI | THREADED | 12" | 16244 | |
| A2 | 3/4 | 200 PSI | ↓ | 14" | 16245 | |
| A3 | 1 | 200 PSI | | 14" | 16247 | |
| A4 | 1 1/4 | 175 PSI | | 18" | 16248 | |
| A5 | 1 1/2 | 150 PSI | | 18" | 16249 | |
| A6 | 2 | 125 PSI | | 18" | 16250 | |
| A7 | 2 1/2 | 100 PSI | | 24" | 16252 | |
| A8 | 3 | 60 PSI | | 24" | 16254 | |

JETSWET

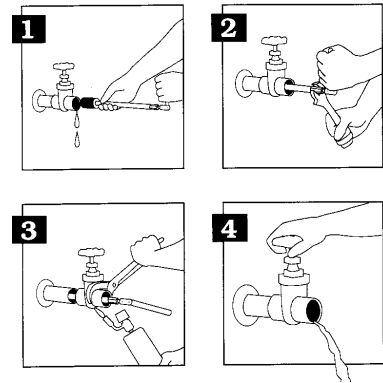
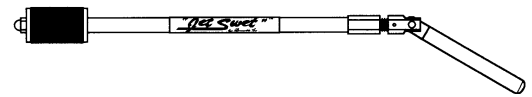

Allows dry soldering of support or cementing of plastic pipe with water in line. Used to repair pinholes, replace elbows or replace valves.

| SIZE | FIG. NO. | PRICE |
|--------|----------|-------|
| 1/2" | 47508 | |
| 3/4" | 47509 | |
| 1" | 47510 | |
| 1 1/4" | 47511 | |
| 1 1/2" | 47512 | |
| 2" | 47513 | |
| 2 1/2" | 47514 | |
| 3" | 47515 | |
| 4" | 47516 | |

Set of 1/2", 3/4" & 1" with case

| FIG. NO. | PRICE |
|--|-------|
| 47507 | |
| Set of 1/2", 3/4", 1", 1 1/4", 1 1/2" & 2" with case | |
| FIG. NO. | PRICE |
| 47506 | |

QUICK SWEAT KIT

For 1/2" - 3/4" - 1" Copper!



| FIG. NO. | PRICE |
|----------|-------|
| 85052 | |

REPLACEMENT GASKETS IN STOCK!

DRAIN KING



**1" TO 2" DRAINS
UNCLOGS:**

- *Swimming Pools
- * Bathtubs and showers
- * Bathroom sink
- *Only model to work in bathroom sink

| FIG. NO. | OEM NO. | PRICE |
|----------|---------|-------|
| 16289 | 501 | |



**1 1/2" TO 3" DRAINS
UNCLOGS:**

- *Kitchen sinks
- * Showers
- * Washing machine drains
- * Bathtubs

| FIG. NO. | OEM NO. | PRICE |
|----------|---------|-------|
| 16287 | 186 | |



**3" TO 6" DRAINS
UNCLOGS:**

- *Main drains
- *Outside deck drains
- *Basement drains

| FIG. NO. | OEM NO. | PRICE |
|----------|---------|-------|
| 16291 | 750 | |

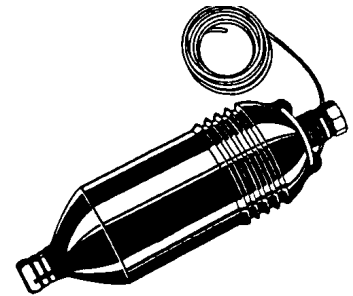

**6" TO 10" DRAINS
FOR COMMERCIAL USE**

| FIG. NO. | OEM NO. | PRICE |
|----------|---------|-------|
| 51071 | 6810 | |

DRAIN KING is made of durable rubber. It is extremely strong, and flexes under pressure with a powerful muscular action that forces jets of water through the surge valve and up to the blockage. Pulsations continue automatically until the obstruction is loosened and flushed through the drain—no harsh chemicals, no long waits.

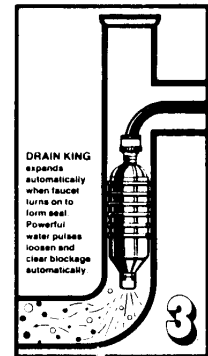
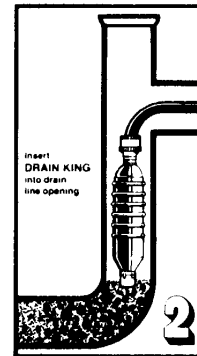
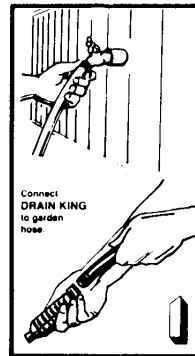

Cherne Test Ball Plugs and Accessories

CHERNE TEST-BALL PLUGS



1 1/4" - 1 1/2" 2" 3"



8"



10"

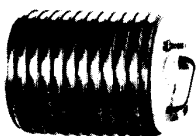

12"



4"



5"

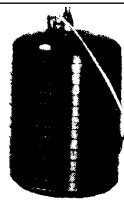

6"

| SIZE | FIG. NO. | PRICE |
|--------|----------|-------|
| 1 1/2" | 7570 | |
| 2 | 7571 | |
| 3 | 7573 | |
| 4 | 7575 | |
| 5 | 7577 | |
| 6 | 7580 | |
| 8 | 7582 | |
| 10 | 7584 | |
| 12 | 7586 | |

CHERNE PETCOCK ASSEMBLY

The petcock assembly helps retain full inflation pressure with 1 1/4" - 1 1/2", and 2" test ball plugs when the test pump is being disconnected.

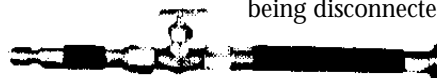

| FIG. NO. | PRICE |
|----------|-------|
| 47216 | |

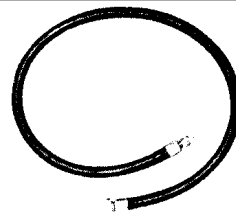

Extension Hose Assembly

The extension hose makes testing with the test-ball plug in longer reaches easier.

| SIZE | FIG. NO. | PRICE |
|------|----------|-------|
| 24" | 7591 | |
| 36" | 7595 | |
| 60" | 7596 | |



CHERNE TEST PUMP WITH GAUGE

A heavy duty air pump designed for use with the Cherne Test-ball plug. The pump is complete with brass check valve, unbreakable pressure gauge and cast iron base. The 36" hose has a quick coupler disconnect device which allows for instant release from the test-ball plug.

| FIG. NO. | PRICE |
|----------|-------|
| 7589 | |

ELECTRIC SOLDERING TOOL



A compact portable soldering tool for copper fitting. Electrically operated, the power pack converts 115 AC line voltage to low voltage high amperage current. When two carbon electrodes in the gun tip contact the copper joint to be soldered, the heating begins. Clean and easy to use. Safe to use near wood or flammable material because there is no open flame. Handle stays cool. Light is on when ready for use. Makes 3/8" - 2" soldered joints.

| | |
|-------------------|------------------------------------|
| Input | 110/120 volts, 50/60 Cycles, 15 |
| Output | Amps 5.2 volts, 275 Amps, |
| Output Cord Reach | 15/750 Watts |
| Duty Cycle | 10 Feet |
| Weight | 50% |

| FIG. NO. | PRICE |
|------------------------------------|-------|
| 58461 | |
| REPLACEMENT ELECTRODES ONLY | |
| 38840 | |

FLARETOOL

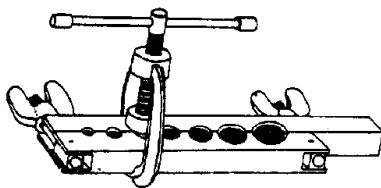

FLARESET

| FIG. NO. | PRICE |
|----------|-------|
| 44697 | |

FLARING TOOL

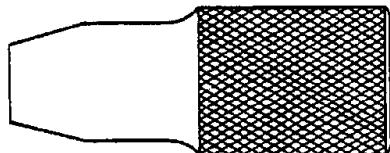

For additional information call: 610-275-4453 or Fax: 610-279-6299
Please call for current prices.

TORCH HOLDER

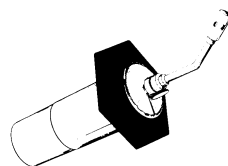

LIKE A THIRD HAND!
AIMS BURNER TIP AT THE WORK
LEAVING BOTH
OF YOUR HANDS FREE.

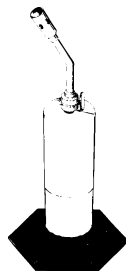

KEEPS TORCH UPRIGHT.
REDUCES CHANCE OF
ACCIDENT FROM TOPPLING
CYLINDER.

TORCH HOLDER

| FIG. NO. | PRICE |
|----------|-------|
| 49324 | |

**SWEDGING TOOL
3/8" TO 3/4"
For copper tube**



| FIG. NO. | PRICE |
|----------|-------|
| 12595 | |

**SWEDGE TOOL
For copper tube**



1 1/4", 1 3/8", 1 1/2"

| FIG. NO. | PRICE |
|----------|-------|
| 12593 | |

FLAMESHIELD

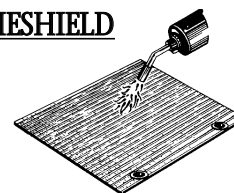

| FIG. NO. | PRICE |
|----------|-------|
| 36423 | |

COLD FIRE



RAPIDLY cools down heated surfaces

Helps to eliminate heat damage to valves and controls

Areas of use:

Boilers & Furnaces, Vanities, Crawl Spaces, Under sinks

Environmentally friendly, non-corrosive, biodegradable, non-staining, no messy cleanup

| FIG. NO. | PRICE |
|----------|-------|
| 82784 | |

COPPER BENDING SPRING

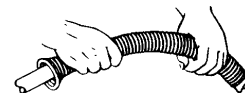

| OD SIZE | FIG. NO. | PRICE |
|---------|----------|-------|
| 1/4 | 13613 | |
| 5/16 | 13614 | |
| 3/8 | 13615 | |
| 7/16 | 13616 | |
| 1/2 | 13617 | |
| 5/8 | 13618 | |
| 3/4 | 13619 | |
| 7/8 | 13620 | |

HAMMER FLARING TOOL

| ID SIZE | FIG. NO. | PRICE | SIZE | FIG. NO. | PRICE | SIZE | FIG. NO. | PRICE |
|---------|----------|-------|-------|----------|-------|-------|----------|-------|
| 3/8 | 13605 | | 3/4 | 13608 | | 1 1/2 | 13611 | |
| 1/2 | 13606 | | 1 | 13609 | | 2 | 13612 | |
| 5/8 | 13607 | | 1 1/4 | 13610 | | | | |

TANKS

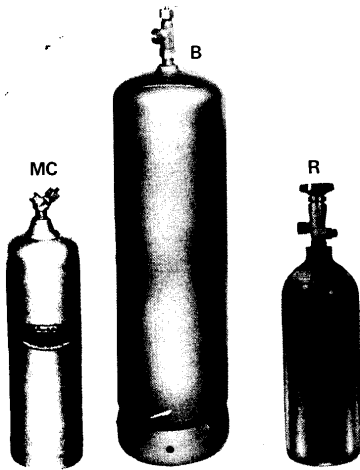

OUTRIGHT

| | FIG. NO. | PRICE |
|----------|----------|-------|
| B Tank | 11084 | |
| MC Tank | 11087 | |
| R Tank | 11100 | |
| OXY Tank | 11103 | |

EXCHANGE

| | FIG. NO. | PRICE |
|----------|----------|-------|
| B Tank | 11084X | |
| MC Tank | 11087X | |
| R Tank | 11100X | |
| OXY Tank | 11103X | |

PROPANE TANKS

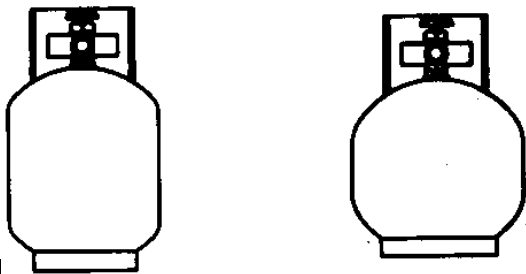

OUTRIGHT

| | FIG. NO. | PRICE |
|-----------------|----------|-------|
| Plumbers'K Tank | 11096 | |
| I Tank (BBQ) | 11090 | |

EXCHANGE

| | FIG. NO. | PRICE |
|-----------------|----------|-------|
| Plumbers'K Tank | 11096X | |
| I Tank (BBQ) | 11090X | |

GASES



Disposable Propane tank with tip.

| FIG. NO. | PRICE |
|----------|-------|
| 11105 | |

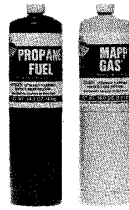

| | FIG. NO. | PRICE |
|----------|----------|-------|
| Propane | 11079 | |
| Mapp Gas | 11080 | |

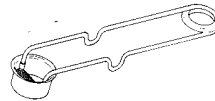

Flint Lighter.

| FIG. NO. | PRICE |
|-------------------------------|-------|
| 11074 | |
| Renewal Flints Only. (6 PACK) | |
| FIG. NO. | PRICE |
| 11075 | |

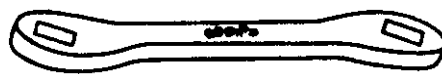

Acetylene Key.

| FIG. NO. | PRICE |
|----------|-------|
| 42974 | |



CYLINDER CARRYING STAND -
Strong and compact; molded handle grips.

| FIG. NO. | PRICE |
|----------|-------|
| 38026 | |

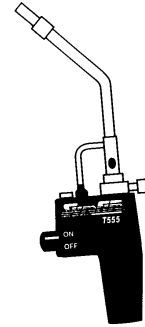

Surefire flame tip - Fully adjustable flame control. Instant ON-OFF trigger improves fuel savings and convenience. Durable, high-quality cast aluminum. Burns efficiently in any position.

| FIG. NO. | PRICE |
|----------|-------|
| 17999 | |

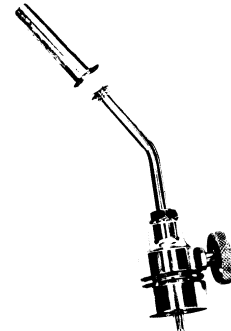

Pencil Flame Torch - All brass Construction; Operates efficiently on Mapp or Propane; Adjustable pencil point flame to large bush flame; Fits all disposable cylinders.

| FIG. NO. | PRICE |
|----------|-------|
| 11107 | |

WE ACCEPT VISA AND MASTERCARD!

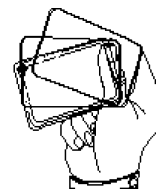

AIR ACETYLENE KITS

ACETYLENE STARTER KIT



AIR-ACETYLENE STARTER KIT includes:

- * 440G "B" cylinder regulator
- * 2AM Torch Handle
- * 3A Torch Tip
- * AH3 12.5 ft. 3/16" ID hose with 3/8" L.H. "A" fittings
- * Spark lighter

| | FIG. NO. | PRICE |
|--------|----------|-------|
| B KIT | 42962 | |
| MC KIT | 42961 | |

CHROME PLATED TIPS

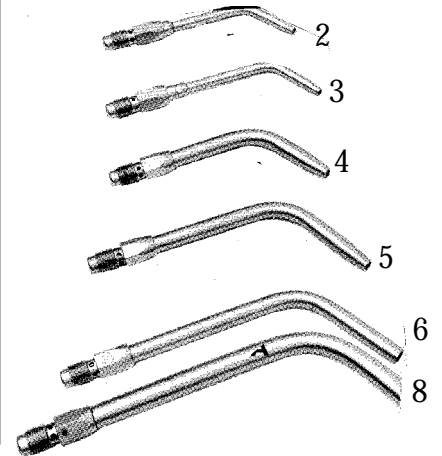

HOSES



3/16" ID
ACETYLENE
HOSE
GRADE R



Acetylene hose with spring-reinforced ends.
12/5 FT with 3/8" LH "A" fittings

| FIG. NO. | PRICE |
|----------|-------|
| 50779 | |

| DESCR | FIG. NO. | PRICE |
|-----------------------------------|----------|-------|
| 12.5 FT with 3/8" LH "A" fittings | 6588 | |
| 25 FT with 3/8" LH "A" fittings | 6594 | |

TORCH HANDLE



Handle with front control valve for one hand finger tip control.

| FIG. NO. | PRICE |
|----------|-------|
| 6612 | |

ACETYLENE REGULATOR

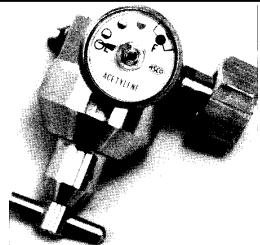

| DESCR | FIG. NO. | PRICE |
|-----------------------|----------|-------|
| B Regulator Complete | 6575 | |
| MC Regulator complete | 6582 | |
| Acetylene Gauge Only | 7055 | |



| DESCR | FIG. NO. | PRICE |
|--|----------|-------|
| TS-2 Very fine flame; wire soldering; jewelry, electronic and optical work. | 60720 | |
| TS-3 Fine flame; light refrigeration and control soldering work; auto radiator work. | 42963 | |
| TS-4 Flame suitable for soldering 3/8" to 3/4" copper tubing; cable connections; sheet metal work. | 42964 | |
| TS-5 Medium flame suitable for soldering 3/4" to 1 1/2" tubing; body and fender work. | 42965 | |
| TS-6 Heavy heating work; pipe thawing. | 42966 | |
| TS-8 Largest flame available to heat large areas. | 72745 | |

CYLINDER TO REGULATOR ADAPTERS

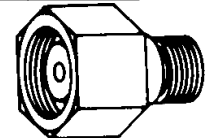
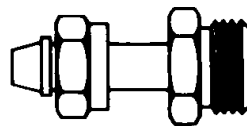

| DESCR | FIG. NO. | PRICE | DESCR | FIG. NO. | PRICE |
|---------|----------|-------|---------|----------|-------|
| MC TO B | 42981 | | B TO MC | 7052 | |

TURBO TORCH ACETYLENE SYSTEM

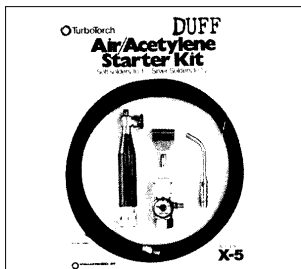

X-5 Starter Kit - soft solders to 1 1/2". Silver solders to 7/8". For the person who want a kit to which he can add tips for his application and needs. Kit includes: regulator, hose, quick disconnect handle, 6530 tip and heat shield.

| FIG. NO. | PRICE |
|----------|-------|
| 6496 | |



X-3 Starter Kit - soft solders to 1 1/2". Silver solders to 7/8". For the person who want a kit to which he can add tips for his application and needs. Kit includes: regulator, hose, quick disconnect handle, 6530 tip and heat shield.

| FIG. NO. | PRICE |
|----------|-------|
| 6441 | |



X-4 Kit - For tough silver brazing and bronze brazing jobs in air conditioning and refrigeration. Soft solders 3/4" to 4". Silver brazes 3/8" to 4". Includes A5 and A14 tips, pre-set regulator, handle and hose.

| FIG. NO. | PRICE |
|----------|-------|
| 6449 | |

CUSTOMERS COME FIRST!

HANDY HAND



This tool is ideal for retrieving small objects trapped in basins, sewer drains, etc. It is also helpful for starting bolts, nuts and screws in hard to get at spots.

| FIG. NO. | PRICE |
|----------|-------|
| 17481 | |

DUFF differs

ACETYLENE TIPS

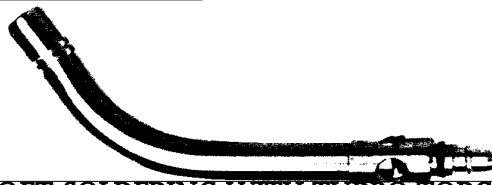

SOFT SOLDERING WITH TURBO TORCH-ACETYLENE

| TUBING SIZE | FIG. NO. | PRICE |
|----------------|----------|-------|
| 1/4" to 1 1/2" | 6509 | |
| 1/4" to 1" | 6521 | |
| 3/4" to 1 1/2" | 6530 | |
| 1" to 2" | 6540 | |
| 1 1/2" to 3" | 6546 | |
| 2" to 4" | 6553 | |
| Over 3" | 6563 | |

SILVER SOLDERING WITH TURBO TORCH-ACETYLENE

| TUBING SIZE | FIG. NO. | PRICE |
|------------------|----------|-------|
| 1/8" to 3/4" | 6509 | |
| 1/8" to 3/8" | 6521 | |
| 3/8" to 7/8" | 6530 | |
| 5/8" to 1 1/8" | 6540 | |
| 7/8" to 1 5/8" | 6546 | |
| 1 1/8" to 2 1/8" | 6553 | |
| 1 5/8" to 4 1/8" | 6563 | |



Pressure Regulator - Durable, accurate, easy to use. Modern, compact design protects regulators, gauge and hose from breakage even if tank falls over. Made for B and MC tanks. Fixed pressure and adjustable models.

| FIG. NO. | PRICE |
|----------|-------|
| B | 6575 |
| MC | 6582 |

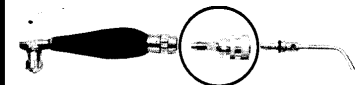

Snappy Adapter

Snappy Adapter - Screws into your prestolite or other handle adapting it to Turbo Torch tips. Provides the advantages of Turbo Torch at lowest cost.

| FIG. NO. | PRICE |
|----------|-------|
| 6616 | |



3/16" ID HOSE.

PROPANE HOSE

| FIG. NO. | PRICE |
|----------|-------|
| 12' | 7027 |
| 24' | 7029 |

ACETYLENE HOSE

| FIG. NO. | PRICE |
|----------|-------|
| 12' | 6588 |
| 24' | 6594 |



Handle - features exclusive "quick disconnect". Snap in the right tip...change to another in seconds...never a need to use wrong size tip.

| FIG. NO. | PRICE |
|----------|-------|
| 6612 | |

TURBO TORCH, AIR/LP UNITS/ACCESSORIES
LP TIPS

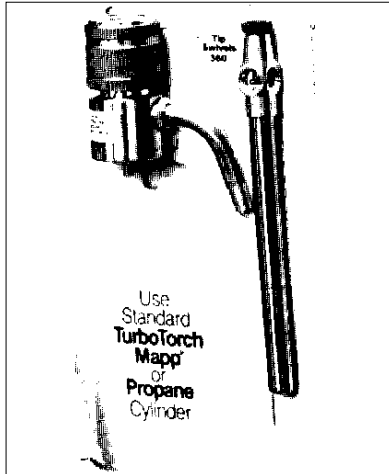

STK-9 Kit - for the professional. 360 degree swivel tips for easy, a rugged brass regulator, and easy to clean orifice. Lets you choose the gas for silver soldering copper tubing, bronze brazing steel pipe, or solder with water in the line. Includes pressure regulator, Tip, Mapp Tank and striker in rugged plastic box.

| FIG. NO. | PRICE |
|----------|-------|
| 7035 | |



LP Kit - Soft solders to 2 1/2". Silver brazes to 1 1/4". Includes: Adjustable regulator, handle, hose, tip and striker.

| FIG. NO. | PRICE |
|----------|-------|
| 6643 | |



| COPPER TUBING SIZE CAPACITY - PROPANE GAS | | | |
|---|---------------|------------|-------|
| SOFT SOLDER | SILVER SOLDER | FIGURE NO. | PRICE |
| 1/8 - 1/4 | 1 1/16 - 1/4 | 6674 | |
| 1/4 - 1 | 1/8 - 1/2 | 6694 | |
| 1/4 - 1 1/2 | 1/4 - 3/4 | 6699 | |
| 1 1/2 - 2 1/2 | 1/2 - 1 1/4 | 6706 | |
| 1 1/2 - 4 | 3/4 - 2 | 6710 | |

| COPPER TUBING SIZE CAPACITY - MAPP GAS | | | |
|--|---------------|------------|-------|
| SOFT SOLDER | SILVER SOLDER | FIGURE NO. | PRICE |
| 1/8 - 1/2 | 1/8 - 1/4 | 6674 | |
| 1/4 - 1 1/2 | 1/4 - 1/2 | 6694 | |
| 1/4 - 2 1/2 | 1/4 - 1 1/4 | 6699 | |
| 1 - 4 | 1/2 - 2 | 6706 | |
| 1 1/2 - 6 | 3/4 - 4 | 6710 | |

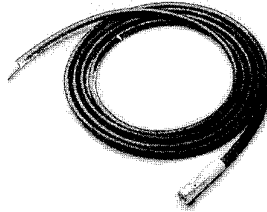

TOTAL LP HOSE - 3/16" ID LP hose with 9/16" 18 LH thread. For Propane.

| SIZE | FIG. NO. | PRICE |
|-------|----------|-------|
| 12 FT | 7027 | |
| 24 FT | 7029 | |



| DESCRIPTION | FIG. NO. | PRICE |
|---|----------|-------|
| Silverflow - substitute for 6% - 15% silver content brazing alloys. For copper tubing installations, large and small. Self fluxing on copper. | 7045 | |
| Bronzeflow - Bronze brazing. Low fuming, flux control. Ideal for joining steel to steel or steel to copper in new or repair work. | 7040 | |

DUFF IS ALWAYS ON CALL 365 DAYS A YEAR 24 HOUR EMERGENCY SERVICE!

For additional information call: 610-275-4453 or Fax: 610-279-6299
 Please call for current prices.

DUFF CO.

BRUSHES

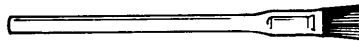

ACID BRUSH

| | FIG. NO. | PRICE |
|------------|----------|-------|
| EACH | 16400 | |
| BOX OF 144 | 67042 | |

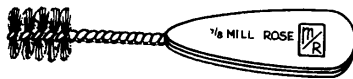

FITTING BRUSH

| SIZE | FIG. NO. | PRICE |
|-------|----------|-------|
| 1/4 | 16253 | |
| 3/8 | 16259 | |
| 1/2 | 16260 | |
| 5/8 | 16261 | |
| 3/4 | 16264 | |
| 7/8 | 16267 | |
| 1 | 16271 | |
| 1 1/4 | 16273 | |
| 1 1/2 | 16277 | |
| 2 | 16280 | |

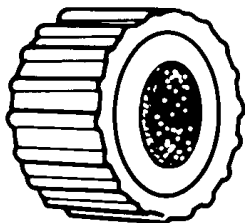

COPPER TUBE BRUSH

| SIZE | FIG. NO. | PRICE |
|------|----------|-------|
| 1/8 | 16284 | |
| 1/4 | 16286 | |
| 3/8 | 16300 | |
| 1/2 | 16302 | |
| 3/4 | 16305 | |

Utility Brush

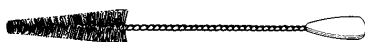

5/8 x 1 5/8 x 29

| FIG. NO. | PRICE |
|----------|-------|
| 50305 | |

COPPER FITTING TOOLS

4-IN-1 TOOL

| FIG. NO. | PRICE |
|----------|-------|
| 16402 | |

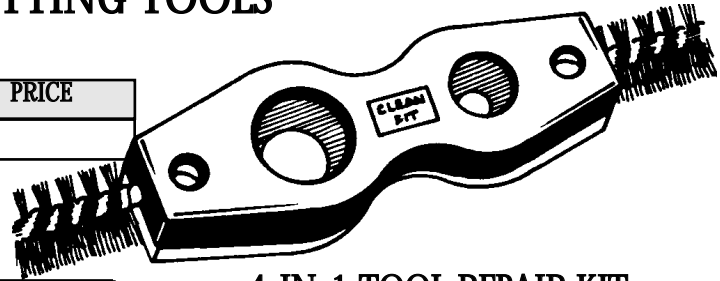

**CALL DUFF FIRST
FOR ALL YOUR TOOL
NEEDS!**

4-IN-1 TOOL REPAIR KIT



| FIG. NO. | PRICE |
|----------|-------|
| 37983 | |

GRIT CLOTH

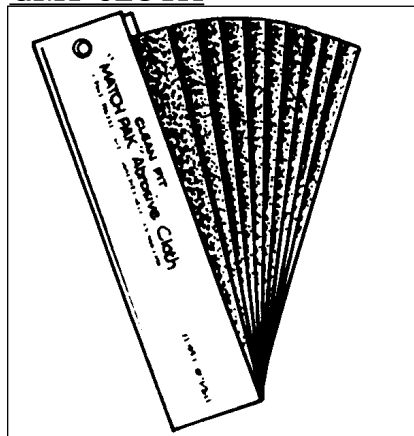

GRIT CLOTH

| FIG. NO. | PRICE |
|----------|-------|
| 20296 | |

ABRASIVE PADS



4X6 ABRASIVE PADS

| FIG. NO. | PRICE |
|----------|-------|
| 16408 | |

STEEL WOOL



STEEL WOOL

| FIG. NO. | PRICE |
|--------------|-------|
| SLEEVE 66912 | |

OPEN GRIT

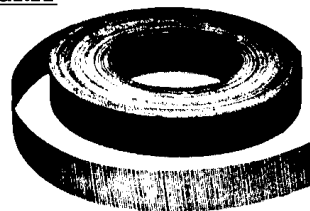

PERMANENT SAND CLOTH

| SIZE | FIG. NO. | PRICE |
|-------------|----------|-------|
| 1 1/2 X 25' | 16398 | |
| 1 1/2 X 10' | 43188 | |



PLUMBER'S SAND CLOTH

| SIZE | FIG. NO. | PRICE |
|-------------|----------|-------|
| 1 1/2 X 10' | 16395 | |
| 1 1/2 X 25' | 16393 | |

SCRATCH BRUSHES

BENT HANDLE SCRATCH BRUSH
4 X 18 ROWS



Best quality. Solid Appalachian hard wood handles and backs - tough, quality, oil tempered, carbon steel fill wire.

| FIG. NO. | PRICE |
|----------|-------|
| 16410 | |

STRAIGHT BACK SCRATCH BRUSH
6 X 19 ROWS



Best quality. Solid Appalachian hard wood handles and backs - tough, quality, oil tempered, carbon steel fill wire.

| FIG. NO. | PRICE |
|----------|-------|
| 16413 | |

FINE WIRE HAND SCRATCH BRUSH
3 X 7 ROWS



Plastic handle. Brass bristles.

| FIG. NO. | PRICE |
|----------|-------|
| 58034 | |

NYLON TUBE BRUSH
1/2" diameter X 30"

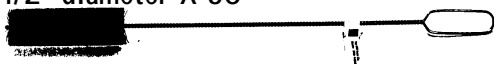

For cleaning boilers, burners, radiators, flues, vents and nozzles! Also GREAT for cleaning gauge glass!

| FIG. NO. | PRICE |
|----------|-------|
| 63946 | |

DOPE BRUSH

Acid, Solder paste & flux, adhesive applicator brushes



| FIG. NO. | PRICE |
|----------|-------|
| 16406 | |

WISK BROOM

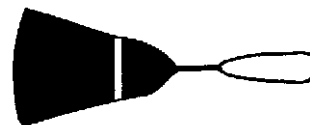

| FIG. NO. | PRICE |
|----------|-------|
| 34724 | |

**24 HOUR
EMERGENCY
SERVICE...**

**Just another way
DUFF DIFFERS!**

CONDENSER TUBE & HEAT EXCHANGER BRUSHES



All brushes have an 11/32" diameter coupling with a 5/16-18 internal thread and 1/8" NPT outside.

There is no O.D. thread on 3/8" brushes.

Brush lengths are 4 1/2", 7 1/2" overall length.

| SIZE | FIG. NO. | PRICE |
|-------|----------|-------|
| 3/8 | 16334 | |
| 7/16 | 16337 | |
| 1/2 | 16343 | |
| 9/16 | 16345 | |
| 5/8 | 16348 | |
| 11/16 | 16351 | |
| 3/4 | 16355 | |
| 13/16 | 16358 | |
| 7/8 | 16360 | |
| 15/16 | 16363 | |
| 1 | 16366 | |
| 1 1/8 | 16368 | |
| 1 1/4 | 16372 | |
| 1 3/8 | 16373 | |
| 1 1/2 | 16375 | |
| 1 5/8 | 16377 | |
| 1 3/4 | 16379 | |
| 1 7/8 | 16381 | |
| 2 | 16383 | |
| 2 1/4 | 16384 | |
| 2 1/2 | 16386 | |
| 2 3/4 | 16389 | |
| 3 | 16391 | |

CONDENSER TUBE BRUSH EXTENSION HANDLES

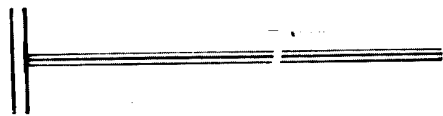

| SIZE | FIG. NO. | PRICE |
|---|----------|-------|
| 36" Handle w/ male thread | 16328 | |
| 24" ext-male one end, female on the other | 16331 | |

FLUE & BOILER TUBE BRUSHES



Quality flue and boiler brushes. Engineered from durable black oil-temperd wire.

All brushes have an overall length of 8" and brush length of 4 1/2"

All brushes are 1/4" NPT Male.

| FIG. NO. | BRUSH DIAMETER | FLUE DIAMETER | PRICE |
|----------|----------------|---------------|-------|
| 52361 | 1 1/4" | 1 1/2" | |
| 52362 | 1 1/2" | 1 3/4" | |
| 85746 | 1 3/4" | 2" | |
| 85748 | 2" | 2 1/4" | |
| 85749 | 2 1/4" | 2 1/2" | |
| 85750 | 2 1/2" | 2 3/4" | |
| 52363 | 2 3/4" | 3" | |
| 44927 | 3" | 3 1/4" | |
| 44922 | 3 1/4" | 3 1/2" | |
| 44923 | 3 1/2" | 3 3/4" | |
| 44924 | 3 3/4" | 4" | |
| 52360 | 4" | 4 1/4" | |

CHIMNEY BRUSHES

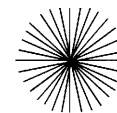

Standard Round Wire Brush

| FIG. NO. | DESCRIPTION | PRICE |
|----------|-------------|-------|
| 16307 | 5" round | |
| 16310 | 6" round | |
| 16312 | 8" round | |
| 16314 | 9" round | |
| 16318 | 10" round | |
| 16321 | 11" round | |
| 16323 | 12" round | |
| 16326 | 14" round | |

ALSO AVAILABLE!

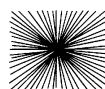

Standard Square Wire Brush



Standard Rectangular Wire Brush

PACKING HOOKS

Packing hooks are time and labor saving tools for removing packings from stuffing boxes. Sturdy and reliable packing pullers that can be used effectively around obstructions and in hard to get at areas. The corkscrew bits, which are securely attached to the flexible steel cable shaft, are made of specially tempered tool steel. Packing hooks are available in six convenient sizes to meet all requirements.

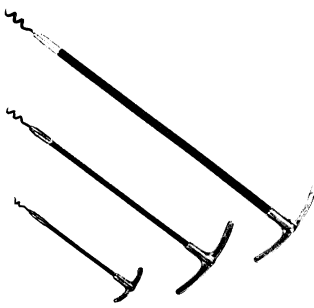

| HOOK # | BIT DIAM | OVERALL LENGTH | USED FOR PACKING SIZES | FIG. NO. | PRICE |
|-------------|----------|----------------|------------------------|----------|-------|
| KIT (1,2,3) | | | | | 17495 |
| 1 | 7/32" | 7 1/2" | 1/4-5/16" | 17496 | |
| 2 | 5/16" | 11" | 3/8" | 17497 | |
| 3 | 3/8" | 15" | 7/16-1/2" | 17499 | |
| 4 | 1/2" | 19" | 9/16-5/8" | 17500 | |
| 5 | 5/8" | 22" | 11/16-1" | 17501 | |



O-ring making kit - Contains all the materials and tools you need to produce stationary o-rings on the spot. You don't need to stock an extensive inventory or endure long waits for delivery of special sizes. Make any size you need in 60 seconds or less - and you can make it right at the machine. Contains: Buna-N V cord - 3 foot lengths of four frequently needed diameters - 3/32", 1/8", 3/16", and 1/4"; Oring splicing fixture - works with various diameter sizes - includes metric scale; Cutter - right in the kit to assure the right length; Permatex pen - for fast, sure high strength bonding.

CENTER-O-PUNCH

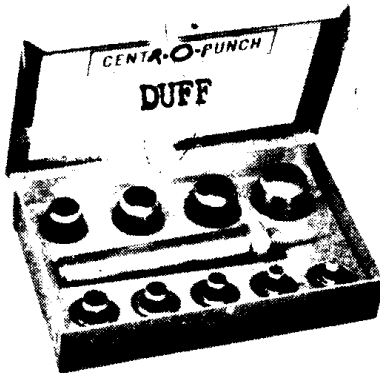

Tools for quick accurate on the job cutting of washers and gaskets. Receding pointed plunger marks the dead center. Material is automatically ejected with each punch. There is no more clogging of dies with resulting loss of time and efficiency. Cutter sizes are 1/4", 5/15", 3/8", 7/16", 1/2", 5/8, 3/4", 7/8", 1". Dies are quickly and easily interchanged. Standard set consists of handle (with spring and plunger assembly) and 9 cutter sizes indicated above, in sturdy steel box.

| SIZE | FIG. NO. | PRICE |
|-------|----------|-------|
| STD | 17503 | |
| JUMBO | 17504 | |

| FIG. NO. | PRICE |
|----------|-------|
| 16208 | |

GASKET CUTTER

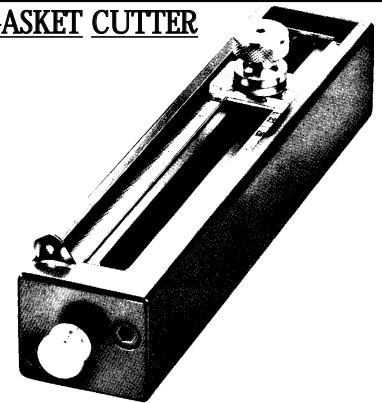

| FIG. NO. | PRICE |
|-----------|-------|
| EACH | 49301 |
| BLADE KIT | 45183 |
| BOARD | 17476 |
| SET | 17475 |

GASKET CUTTER BOARD

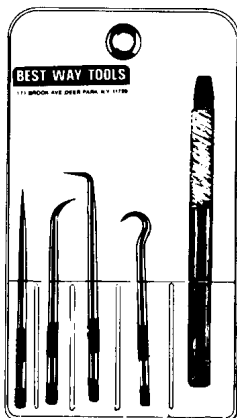
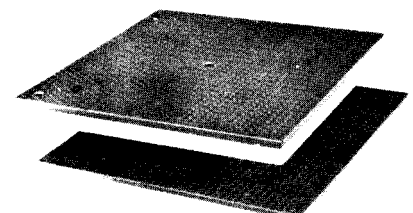

ORING PICK KIT - 5 piece set has straight, 90 deg angle point, double bend point, and hook point. Aluminum handle accepts point quickly and easily with highest scribe. As a small awl, as a hook to pull small springs, a pick up to remove o-rings, boots and gaskets.

| FIG. NO. | PRICE |
|----------|-------|
| 50419 | |

ORING PICK - individual

| FIG. NO. | PRICE |
|----------|-------|
| 50417 | |

For additional information call: 610-275-4453 or Fax: 610-279-6299
Please call for current prices.

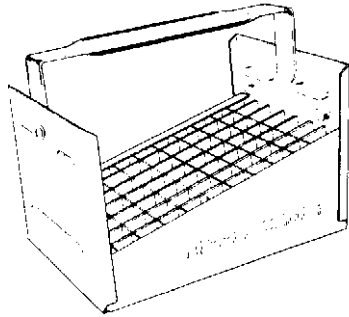

COMBO NIPPLE BOX

Holds both 1/2" and 3/4" nipples
 - Holds 39 1/2" - CL thru 6"
 - Hold 33 3/4" - CL thru 6"
 - Fold away handle
 SORTS SIZES EASILY!

| FIG. NO. | PRICE |
|----------|-------|
| 51243 | |

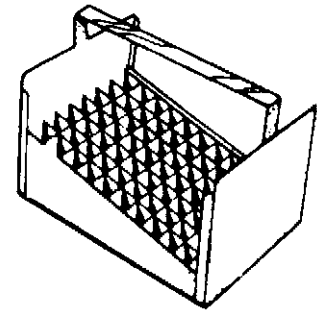

NIPPLE BOX

Enameled Steel
 -Holds 77 1/2" nipples
 -Holds 66 3/4" nipples
 SORTS SIZES EASILY!

| | FIG. NO. | PRICE |
|------|----------|-------|
| 1/2" | 51241 | |
| 3/4" | 51242 | |

IGNITOR TOOL

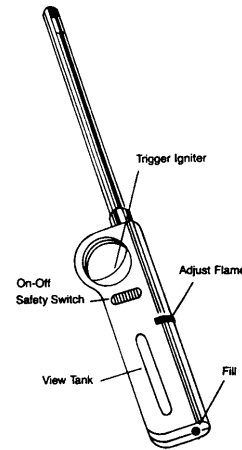

Hand held extended lighter for relighting pilots in hard to reach places.

| FIG. NO. | PRICE |
|----------|-------|
| 43519 | |

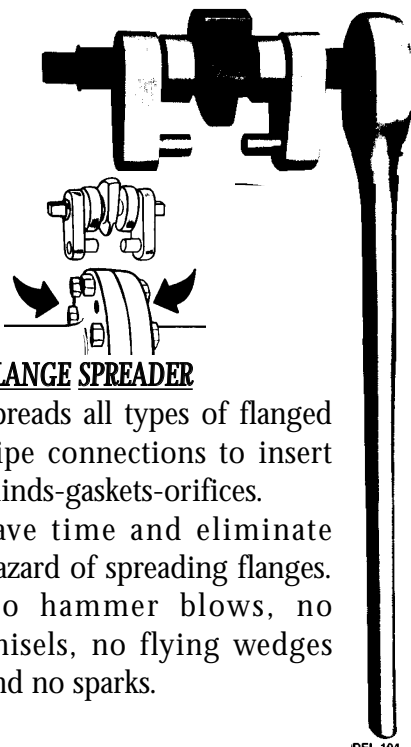

FLANGE SPREADER

Spreads all types of flanged pipe connections to insert blinds-gaskets-orifices. Save time and eliminate hazard of spreading flanges. No hammer blows, no chisels, no flying wedges and no sparks.

| FIG. NO. | PRICE |
|----------|-------|
| 83003 | |

DUFF SELLS SOLUTIONS!
 LET US HELP YOU!
 610-275-4453



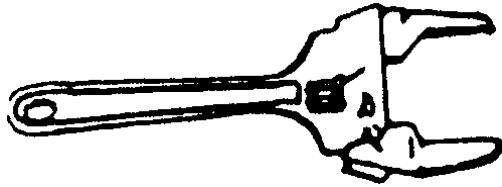

| | |
|------------------------|-------|
| ADJUSTABLE SPUD WRENCH | |
| FIG. NO. | PRICE |
| 64606 | |

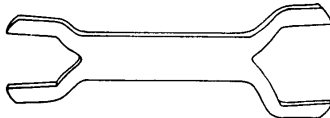

| | |
|--------------------|-------|
| CLOSET SPUD WRENCH | |
| FIG. NO. | PRICE |
| 48666 | |

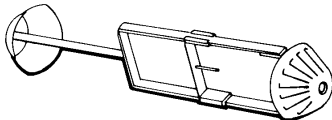

| | |
|----------------------------------|-------|
| STUVEL FLUSH VALVE RESEATER TOOL | |
| FIG. NO. | PRICE |
| 17478 | |



The **CLOSET SEAT NUT WRENCH** is a small, completely enclosed, rigid jaw wrench for turning various closet seat nuts on the elongated bolt used in securing closet seats to water closets. The wrench has an axial bore for the bolt shank, regardless of the length of the shank. The wrench is constructed to engage or disengage the nuts without danger of fracturing non-metallic nuts. The awkward task of tightening or loosening nuts is made easy since BOTH ENDS of the tool are adapted for use with a leverage pin, wrench, or ratchet wrench.

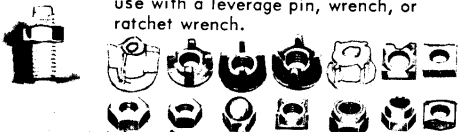

| | |
|------------------------|-------|
| CLOSET SEAT NUT WRENCH | |
| FIG. NO. | PRICE |
| 17486 | |

WATER RAM

OPENS CLOGGED PIPES WITH SHOCK ACTION!

A burst of kinetic energy moves suddenly and swiftly . . . sending a force of 4300 psi to clear stoppages in lines up to 4" dia. Effective around elbows and numerous bends. Bypasses vents. 98% of force hits the stoppage, only 2% reaches pipe walls.

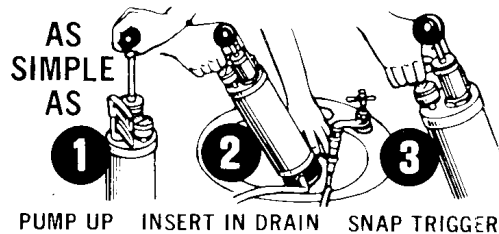

Send for details on General's clean, quick-acting Water Ram.

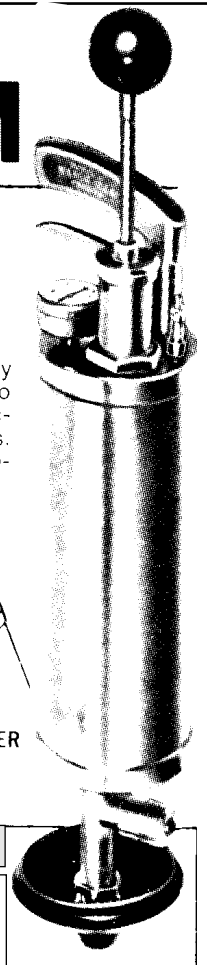

| DESCR | FIG. NO. | PRICE |
|---|----------|-------|
| Kinetic Water Ram, complete with water supply hose, universal faucet adapter, stainless steel clamp, 3-ply caulking hose, 4" tapered rubber cone, five tapered rubber plugs, plus metal carrying case | 15774 | |
| Same as above with 6" tapered rubber cone and 1 1/2", 2", 3" and 4" expansion plungers. | 20577 | |
| Repair Kit | 38072 | |



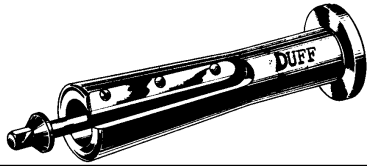

WASHER TRIMMER - A practical tool designed to cut bibb washers to proper size, thereby insuring a perfectly fitting washer. Made of aluminum - precision machined. Cutting blade of tempered swedish steel. Takes washers from 5/8" diameter to No. 00. A QUALITY tool that every plumber should own!

| FIG. NO. | PRICE |
|----------|-------|
| 17482 | |

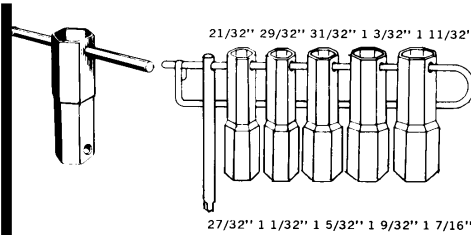

| SHOWER VALVE DEEP SOCKET WRENCH SET | |
|-------------------------------------|-------|
| FIG. NO.. | PRICE |
| 16220 | |



CONE BIBB REAMER - extra long handle for use on shower fixtures, valves and bibbs. Reforms worn, corroded faucet seats with a curved contour like new. Easy and fast to use on all styles and kinds of faucets, globe and stop waste valves.

| FIG. NO.. | PRICE |
|-----------|-------|
| 17469 | |

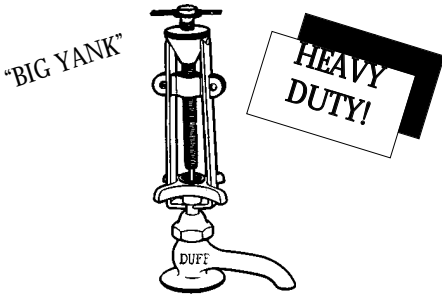

HANDLE PULLER - Removes frozen handles quick and easily.

| FIG. NO. | PRICE |
|----------|-------|
| 51590 | |

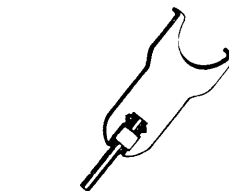

FAUCET WRENCH FOR DELTA-PEERLESS

| FIG. NO. | PRICE |
|----------|-------|
| 15110 | |

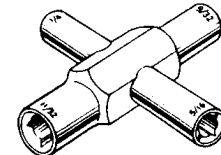

4-WAY SILLCOCK KEY - fits popular make stop cocks with stems 1/4", 9/32", 5/6" and 11/32".

| FIG. NO.. | PRICE |
|-----------|-------|
| 17491 | |

FAX YOUR ORDER TODAY!
610-279-6299

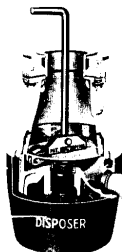

GARBAGE DISPOSER TOOL - frees jammed disposals. Bottom lever of tool tilts to allow easy entrance or exit. Place firmly on bottom inside disposer, turn right and left. Remove tool and turn on disposer switch.

| FIG. NO.. | PRICE |
|-----------|-------|
| 38889 | |

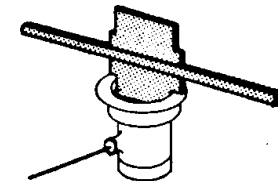

LEVER WASTE INSTALLATION TOOL - for removal or installation of wastes 3" or 3 1/2" openings. Heavy duty stainless steel construction.

| FIG. NO. | PRICE |
|----------|-------|
| 38843 | |

| 11" BASIN WRENCH | | |
|------------------|----------|-------|
| SIZE | FIG. NO. | PRICE |
| 11" | 44698 | |

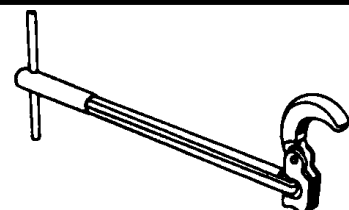

MISCELLANEOUS PLUMBERS' TOOLS

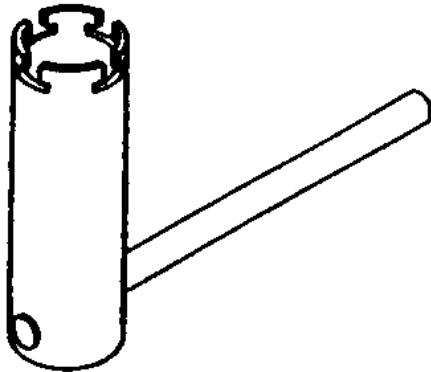

Strainer Wrench - For installing kitchen basket strainers and tub drains with cross bars. Plated steel. Long handle for leverage.

| FIG. NO. | PRICE |
|----------|-------|
| 49833 | |

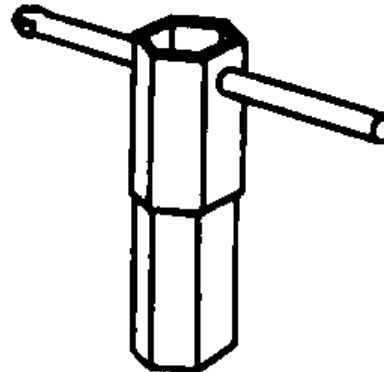

Water Heater Element Socket - Aids in the removal of all brands of water heater elements.

| FIG. NO. | PRICE |
|----------|-------|
| 8718 | |

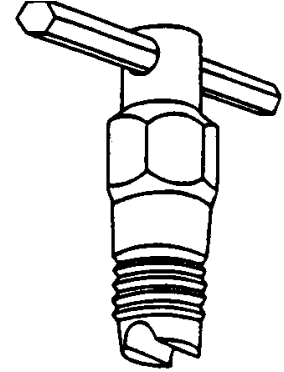

Moen Cartridge Puller - Remove MOEN faucet cartridges with ease.

| FIG. NO. | PRICE |
|----------|-------|
| 17477 | |

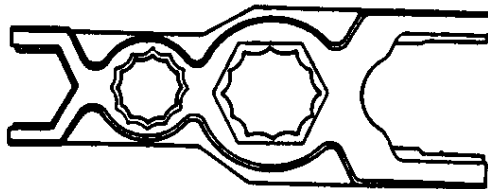

SLOAN FIT ALL SUPER WRENCH

| FIG. NO. | PRICE |
|----------|-------|
| 41550 | |

FITS ALL SLOAN NUTS AND COUPLINGS!

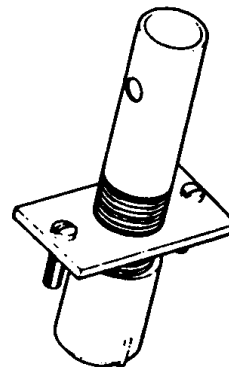

POWERS TOOL

| FIG. NO. | PRICE |
|----------|-------|
| 51081 | |

"QUICK NUTCRACKER"

PATENT NUMBER 4,365,413

Quickly removes corroded 1/2" zinc locknuts from faucet shanks.

- Heat treated cutter blades
- Ball thrust bearings
- Durable black oxide finish
- Will work on faucet shanks with only three threads showing

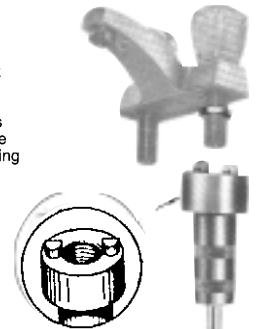

| FIG. NO. | PRICE |
|----------|-------|
| 17752 | |

THE SMART DUMBELL

Fits 95% of all tub drains
Fits 1 1/2" and 2" closet spuds
Installs or removes lift and turn drains with posts
Prevents scratching

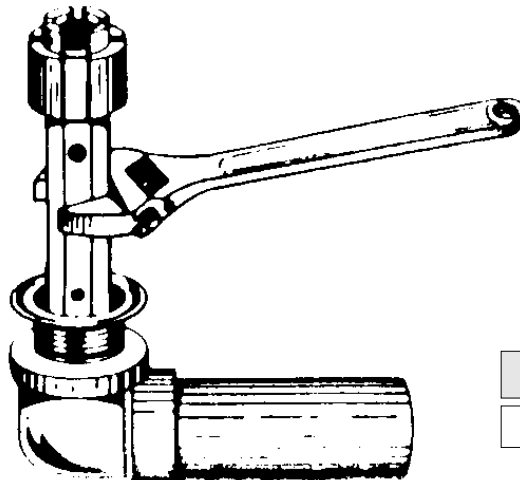

| FIG. NO. | PRICE |
|----------|-------|
| 58658 | |

DIRECTIONS FOR USE

1. Remove water supply tubing, slip joint nut and cone washer from faucet shank.
2. Screw the "QUICK NUTCRACKER" onto the faucet shank.
3. Using a 3/8" ratchet and ratchet extension, drive the tool up on the shank until it engages the nut. Keep tightening and the blades will start cutting through the nut.
4. Check progress of the cutter to make sure it is cutting through the nut.
5. The Nutcracker cuts through the two sides of the nut at different times. Two "pops" will be heard. The first "pop" is one side of the nut splitting and the second "pop" is the other side splitting.
6. The nut halves should now fall off or can be removed.
7. Repeat process with the other shank.
8. Faucet may have to be jiggled to release the broken nut halves.

PLUMBING TOOLS

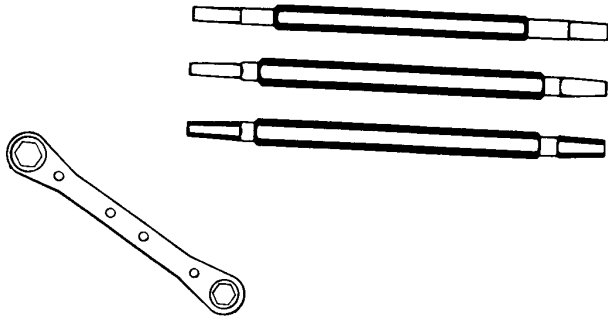

BIBB SEAT REMOVER KIT - Set includes: 1 ea. 3/8" x 7/16" ratcheting box wrench, 1 ea small hex/large hex tapered bibb seat tool, 1 ea small square/large square tapered bibb seat tool, 1 ea small square/large square no taper bibb seat tool.

| FIG. NO. | PRICE |
|----------|-------|
| 12512 | |

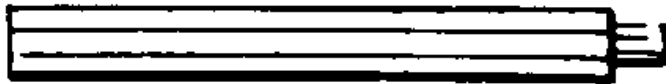

GERBER SEAT WRENCH

| FIG. NO. | PRICE |
|----------|-------|
| 72714 | |

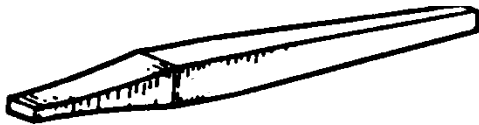

COMBINATION SPUD KEY

| FIG. NO. | PRICE |
|----------|-------|
| 12514 | |

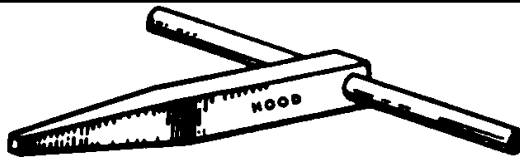

FAUCET SPUD KEY

| FIG. NO. | PRICE |
|----------|-------|
| 12526 | |

SLEEVE SEAT REMOVER
Tapered Ends

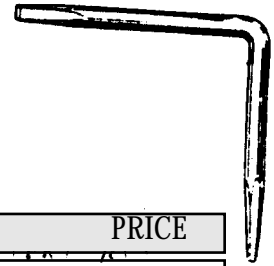

| FIG. NO. | PRICE |
|----------|-------|
| 33818 | |

HEXAGON SEAT REMOVER
Step Ends

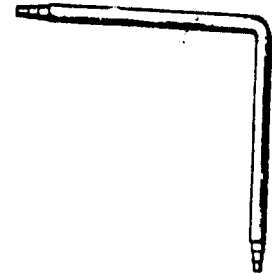

| FIG. NO. | PRICE |
|----------|-------|
| 12543 | |

SMALL FAUCET SEAT REMOVER

Step End
and
Tapered end



| FIG. NO. | PRICE |
|----------|-------|
| 12517 | |

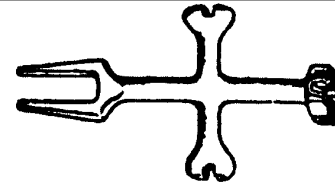

BASIN FORK WRENCH

| FIG. NO. | PRICE |
|----------|-------|
| 57413 | |

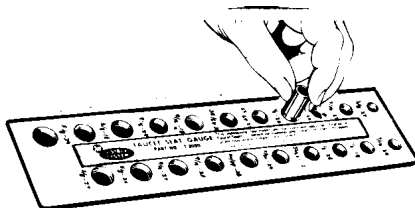

FAUCET SEAT GAUGE - for quick, easy identification of faucet seat threads. 21 drilled and tapped set sizes. Heavy aluminum. thread sizes clearly marked. Threads are identical to OEM threads.

| FIG. NO. | PRICE |
|----------|-------|
| 17488 | |

CAULKING TOOLS

COLD CHISEL

Designed for cutting cast iron or steel* Made in USA

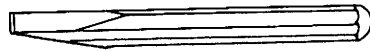

| SIZE | FIG. NO. | PRICE |
|------------|----------|-------|
| 3/4" x 7" | 12409 | |
| 1" x 8" | 44737 | |
| 3/4" x 12" | 19486 | |

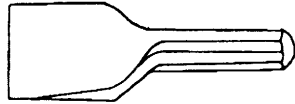

GATE CHISEL

For cutting lead ingots and gate after removing joint runner

| SIZE | FIG. NO. | PRICE |
|----------|----------|-------|
| 2X6 1/2" | 12421 | |

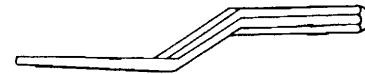

PACKING OR YARNING TOOLS

| SIZE | FIG. NO. | PRICE |
|------------|----------|-------|
| 5/8" x 12" | 12445 | |

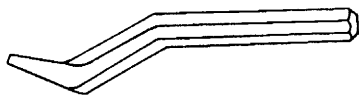

SHORT NOSE PACKING TOOLS

For finishing lead joint

| SIZE | FIG. NO. | PRICE |
|---------------|----------|-------|
| 5/8" x 7 1/2" | 12450 | |

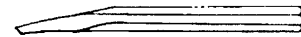

INSIDE CAULKING TOOL

For finishing lead joint

| SIZE | FIG. NO. | PRICE |
|-----------|----------|-------|
| 5/8" x 7" | 12472 | |

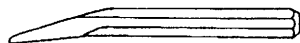

OUTSIDE CAULKING TOOLS

For finishing lead joint

| SIZE | FIG. NO. | PRICE |
|-----------|----------|-------|
| 5/8" x 7" | 20762 | |



BROAD CURVE NOSE CAULKING TOOLS

Used for packing oakum tight
For first pass on lead

| SIZE | FIG. NO. | PRICE |
|--------------------|----------|-------|
| 5/8" x 8" x 1 1/2" | 12483 | |

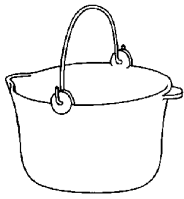

LEAD POT

| SIZE | FIG. NO. | PRICE |
|------|----------|-------|
| 6" | 7439 | |



CAST IRON LADLE

| SIZE | FIG. NO. | PRICE |
|------|----------|-------|
| 3" | 7388 | |

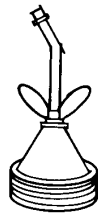

WING NUT TEST PLUG

| SIZE | FIG. NO. | PRICE |
|------|----------|-------|
| 2 | 7431 | |
| 3 | 7432 | |
| 4 | 7433 | |
| 5 | 7434 | |
| 6 | 7435 | |
| 8 | 7436 | |
| 10 | 41558 | |

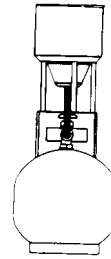

PLUMBERS LEAD MELTING FURNACE LESS TANK

| FIG. NO. | PRICE |
|----------|-------|
| 32322 | |

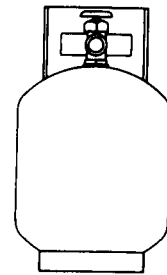

"I" AND "K" PROPANE CYLINDER TANKS

| BBQ (I) | |
|--------------------|-------|
| FIG. NO. | PRICE |
| 11090 | |
| FURNACE (K) | |
| FIG. NO. | PRICE |
| 11096 | |



MARQ II

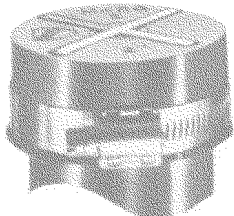

MARQ II TEST CAP

Comes complete with long lasting corrosion resistant gear type clamp for easy tightening with screwdriver or no hub wrench. Fits cast iron pipe, plastic pipe or copper tubing. IAPMO approved for test out and permanent cap-off for drain pipes, waste pipes, and vent pipes (DWV).

| SIZE | FIG. NO. | PRICE |
|-------|----------|-------|
| 1 1/2 | 7603 | |
| 2 | 7604 | |
| 3 | 7605 | |
| 4 | 7606 | |



MARQ II TEST PLUG

A tough test plug tailored to do the job. Made of the finest cold roll steel and neoprene rubber. The only one of it's kind with the unique flange design.

| SIZE | FIG. NO. | PRICE |
|-------|----------|-------|
| 1 | 7597 | |
| 1 1/4 | 7598 | |
| 1 1/2 | 7599 | |
| 2 | 7600 | |
| 3 | 7601 | |
| 4 | 7602 | |
| 6 | 52576 | |

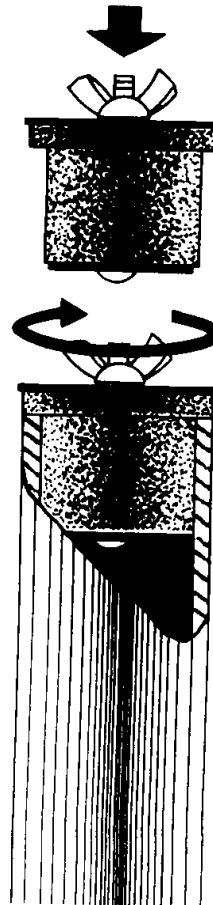

ELECTRIC LEAD MELTING POT

| SIZE | FIG. NO. | PRICE |
|--------|----------|-------|
| 25 LB. | 38829 | |
| 50 LB. | 38830 | |

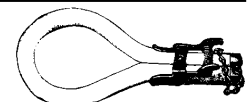

JOINT RUNNER

| SIZE | FIG. NO. | PRICE |
|-------|----------|-------|
| 4"-6" | 12620 | |
| 6"-8" | 12621 | |

ZIP IN

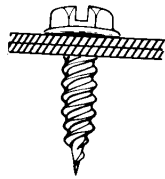

ALL IN 1/4" HEAD SIZE

| SIZE | FIG. NO. | PRICE |
|-------|----------|-------|
| 7X112 | 16178 | |
| 8X12 | 16179 | |
| 8X34 | 16181 | |
| 8X1 | 16182 | |
| 8X112 | 16183 | |
| 10X12 | 16186 | |

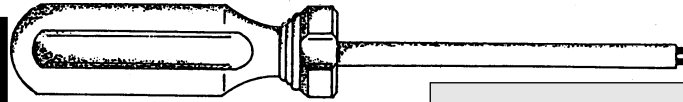

One way screw removal tool.
Great for toilet partitions.

| | FIG. NO. | PRICE |
|-------------------|----------|-------|
| for #6-8 screws | 44045 | |
| for #8-10 screws | 43910 | |
| for #12-14 screws | 43911 | |

MAGNETIC DRILL CHUCKS

Magnetic drill chuck for hex head screws.

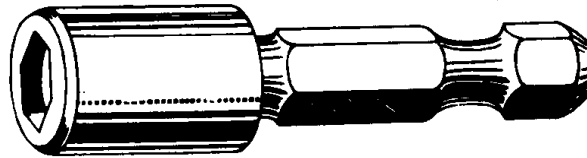

| SIZE | FIG. NO. | PRICE |
|-------|----------|-------|
| 1/4" | 16192 | |
| 3/8" | 16194 | |
| 5/16" | 16193 | |

**FAX US
YOUR
ORDER!**

610-279-6299

NUT SPLITTING TOOL

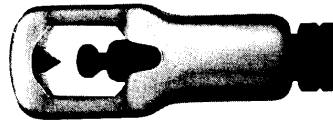

Nut splitting tool. For use in removing rusted and corroded nuts. Forged Steel. Offset for easy use.

| FIG. NO. | PRICE |
|----------|-------|
| 17752 | |

ADAPTER EXTENSIONS

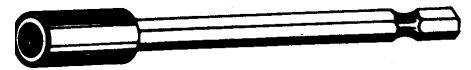

Adapter extensions for extra length in hard to reach places. Fits all hex chuck adapters.

| SIZE | FIG. NO. | PRICE |
|----------|----------|-------|
| 6" LONG | 72718 | |
| 10" LONG | 72719 | |

HEX KEY SET

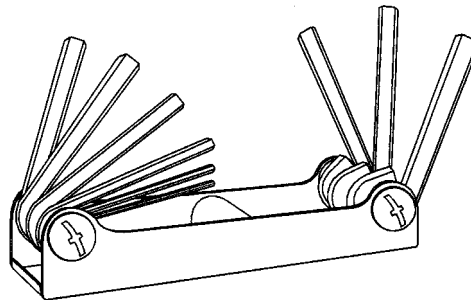

Eliminates looking for the right hex key. All keys fold like a knife into one convenient handle. Snaps into work position for leverage - use at any angle. Keys made of best quality chrome nickel alloy steel. Scientifically hardened for maximum strength. Handle Length - 3".

| FIG. NO. | PRICE |
|-------------|-------|
| .050 - 3/6 | 16150 |
| 5/640 - 1/4 | 16152 |

SCREWDRIVER SET

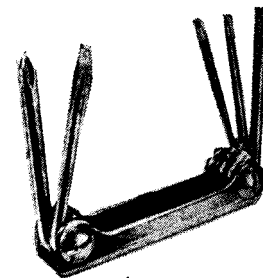

7 IN 1. New combination tool with seven screw driver blades in one complete unit which folds like a pocket knife. All blades made from high quality steel, hardened and tempered. Each blade can be used straight out or at right angles for extra leverage.

| FIG. NO. | PRICE |
|----------|-------|
| 50681 | |

CURB BOX WRENCH

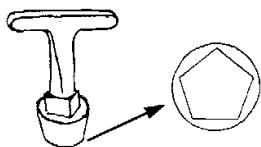

Curb box wrench - for the 5 sided pentagon curb box nuts. Thin wall sockets fit all make boxes.

| FIG. NO. | PRICE |
|----------|-------|
| 12523 | |

For additional information call: 610-275-4453 or Fax: 610-279-6299
Please call for current prices.

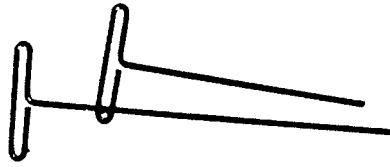

Long reach design with loop handle for greater torque and ease of use. Made of top quality chrome nickel alloy steel - drawn for closet tolerance to insure precise fit into screw head. Hardened and tempered by special martempering process for maximum strength.

| SIZE | FIG. NO. | PRICE |
|------|----------|-------|
| 3/32 | 16153 | |
| 7/64 | 16155 | |
| 1/8 | 16157 | |
| 9/64 | 16158 | |
| 5/32 | 16161 | |
| 3/16 | 16162 | |
| 7/32 | 16165 | |
| 1/4 | 161666 | |
| 5/16 | 16168 | |
| 3/8 | 16170 | |

PLUNGERS

HYDRO THRUST FORCE CUP

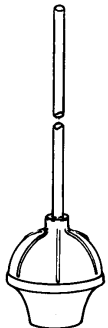

| FIG. NO. | PRICE |
|----------|-------|
| 14627 | |

HEAVY DUTY RED FORCE CUP



4 1/2"

| FIG. NO. | PRICE |
|----------|-------|
| 14628 | |

6"

| FIG. NO. | PRICE |
|----------|-------|
| 47009 | |

COMPLETE DRAINAGE PLUNGERS



Reinforced rubber discs, with cast bronze holder, assembled.

| SIZE | FIG. NO. | PRICE |
|------|----------|-------|
| 2" | 12611 | |
| 3" | 12612 | |
| 4" | 12614 | |

PLUNGER DISCS ONLY



3/8" Fiber reinforced rubber discs for drainage plungers.

| SIZE | FIG. NO. | PRICE |
|------|----------|-------|
| 2" | 12615 | |
| 3" | 12616 | |
| 4" | 12617 | |



INTERNAL SPUD WRENCH

A must to install or remove urinal and closet spuds, waste and overflows. 4" capacity, cushioned grip.

| FIG. NO. | PRICE |
|----------|-------|
| 83501 | |



PLUMB BOB
5 Oz.

| FIG. NO. | PRICE |
|----------|-------|
| 42516 | |

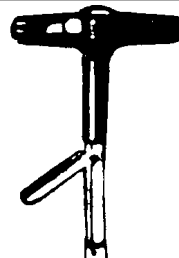

NO HUB TORQUE WRENCH

| FIG. NO. | PRICE |
|----------|-------|
| 13134 | |



12,000 BTU/HR!



THREAD GAUGE
Measures and identifies 18 different thread sizes, seats, etc.

| FIG. NO. | PRICE |
|----------|-------|
| 17483 | |

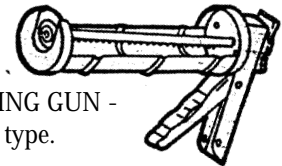

CAULKING GUN - Ratchet type.

| FIG. NO. | PRICE |
|----------|-------|
| 12648 | |



BLUE POLY TARP - 10 times stronger than canvas yet 1/3 lighter! Reinforced corners, grommets every 3'.

| SIZE | FIG. NO. | PRICE |
|-------|----------|-------|
| 10x12 | 64237 | |
| 12x20 | 64238 | |



HOLD-ZIT - rubber straps and fasteners. Long-life, weather resistant rubber for tucks, trailers, cars, to hold down tarps and equipment.

| SIZE | FIG. NO. | PRICE |
|------|----------|-------|
| 15" | 16204 | |
| 22" | 16205 | |
| 31" | 16206 | |

HEATERS

SOLD LESS TANKS!!

| FIG. NO. | PRICE |
|----------|-------|
| 38929 | |

| FIG. NO. | PRICE |
|----------|-------|
| 39280 | |

MISCELLANEOUS SAFETY TOOLS

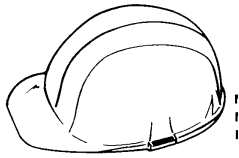

SAFETY HARD HAT - Meets or exceeds OSHA and ANSI X89., 1986 Class A & B specs. One size fits all. 6 point suspensions for added comfort and adjustability. Slotted for replacement headbands and accessories. Rain trough design.

| FIG. NO. | PRICE |
|----------|-------|
| 33572 | |

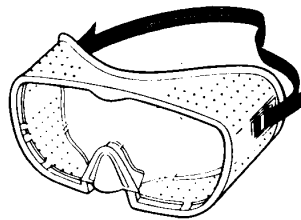

CLEAR SAFETY GOGGLES - Perforated for maximum ventilation. Fits over prescription or sun glasses. Clear, impact resistant lenses. Meets ANSI Z87. and OSHA specs.

| FIG. NO. | PRICE |
|----------|-------|
| 43045 | |



CAUTION TAPE (USA) - Bright yellow printed 'CAUTION'. Non-pressure sensitive OSHA safety yellow. 3" X 300'.

| FIG. NO. | PRICE |
|----------|-------|
| 44078 | |



ALL PURPOSE INDUSTRIAL 3-PIECE RAIN SUIT - Safety yellow with hood. Double fly front with snap fasteners. Suspender type adjustable shoulder straps.

| FIG. NO. | PRICE |
|----------|-------|
| 20306 | |

**DON'T SEE WHAT YOU'RE
LOOKING FOR?
ASK US!
CALL DUFF FIRST FOR ALL YOUR
TOOL NEEDS!
610-275-4453**



WORK GLOVES

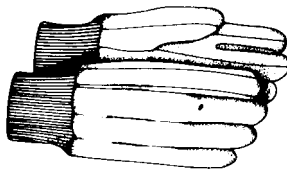

BROWN WORK GLOVES - Button jersey knit wrist, clute cut. One size fits all.

| FIG. NO. | PRICE |
|----------|-------|
| 20297 | |

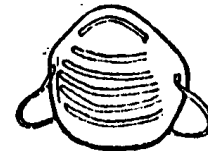

DISPOSABLE DUST MASK - Protects against pollen, dust & paint spray. Use in shop, home, farm, etc.

| FIG. NO. | PRICE |
|----------|-------|
| 45185 | |

LEATHER PALM WORK GLOVES - Perfect for tougher jobs as there are no exposed seams in the palm "wear area".

| FIG. NO. | PRICE |
|----------|-------|
| 42806 | |

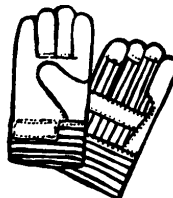

INDUSTRIAL RUBBER WORK GLOVES - Men's black, extra heavy, rolled cuffs. One size fits all.

| FIG. NO. | PRICE |
|----------|-------|
| 50701 | |

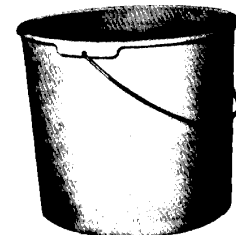

PAILS - Ideal for draining traps, lavatories, sinks, etc. Available in two sizes, complete with hammer-on lid.

| SIZE | FIG. NO. | PRICE |
|------------|----------|-------|
| 3.5 GALLON | 44867 | |
| 5 GALLON | 49386 | |

RIDGID PLIERS



TONGUE AND GROOVE PLIERS

| CAPACITY | LENGTH | FIG. NO. | PRICE |
|---------------|--------|----------|-------|
| 3/4" (19MM) | 7 | 27455 | |
| 1 1/2" (38MM) | 10 | 18915 | |
| 2 1/2" (64MM) | 12 | 27457 | |
| 4" (100MM) | 16 | 27458 | |



HEAVY DUTY SIDE CUTTING PLIERS

| LENGTH | FIG. NO. | PRICE |
|--------------------------|----------|-------|
| 6 | 19776 | |
| 7 | 27466 | |
| LONG REACH PLIERS | | |
| 8 | 27467 | |
| 6 | 25847 | |



WATER PUMP PLIERS

| CAPACITY | FIG. NO. | PRICE |
|-----------|----------|-------|
| 2" (51MM) | 27459 | |



END CUTTING NIPPERS

| FIG. NO. | PRICE |
|----------|-------|
| 27430 | |



SIDE CUTTING PLIERS

| LENGTH | FIG. NO. | PRICE |
|--------|----------|-------|
| 6" | 27460 | |
| 7" | 27461 | |
| 8" | 27462 | |
| 9" | 27463 | |

STANDARD ←



DIAGONAL CUTTING PLIERS

| LENGTH | FIG. NO. | PRICE |
|--------|----------|-------|
| 6 | 27433 | |
| 7 1/2 | 27434 | |
| 7 1/4 | 27436 | |



SLIP JOINT UTILITY PLIERS

| LENGTH | FIG. NO. | PRICE |
|--------|----------|-------|
| 7 | 27438 | |
| 8 | 27439 | |

PLIERS

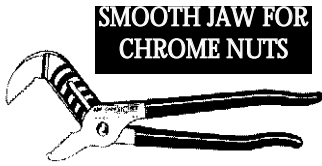

TONGUE AND GROOVE PLEIRS.
Smooth jaw 10" length, 7 adjustments
2" capacity.
Dipped handles. Carded.

| FIG. NO. | PRICE |
|----------|-------|
| 50375 | |

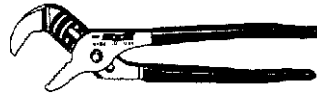

STRAIGHT JAW TONGUE AND GROOVE PLEIRS. Standard design 9 1/2" length, 5 adjustments 1 1/2" capacity. Dipped handles. Carded.

| FIG. NO. | PRICE |
|----------|-------|
| 67718 | |

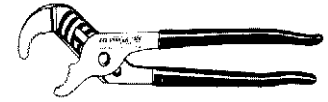

CURVED JAW TONGUE AND GROOVE PLEIRS. Curved jaw 9 1/2" length, 5 adjustments 1 1/2" capacity. Dipped handles. Carded.

| FIG. NO. | PRICE |
|----------|-------|
| 40718 | |

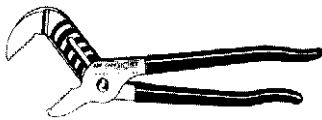

STRAIGHT JAW TONGUE AND GROOVE PLEIRS. Standard design 10" length, 7 adjustments, 2" capacity. Dipped Handles. Carded.

| FIG. NO. | PRICE |
|----------|-------|
| 67632 | |



CURVED JAW TONGUE AND GROOVE PLEIRS. Curved jaw 12" length, 7 adjustments 2 1/4" capacity. Dipped handles. Carded.

| FIG. NO. | PRICE |
|----------|-------|
| 40719 | |

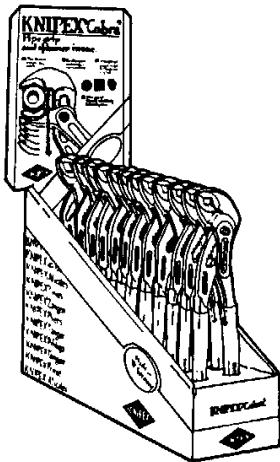

Lightweight, rugged chrome-vanadium steel forging. Patented parallel jaw design insuring non-slip grip on round, hexagonal and square work. Operates with one-handed, downward pressure without squeezing. Cast stop prevents pinched fingers and blood blisters. Positive non-slip, easily adjustable, 11-position construction. PVC plastic coated handles for soft, sure grip.

| | FIG. NO. | PRICE |
|-----|----------|-------|
| 10" | 54323 | |
| 12" | 54324 | |
| 16" | 80834 | |



For additional information call: 610-275-4453 or Fax: 610-279-6299
Please call for current prices.

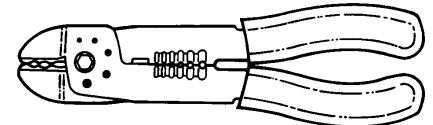

| WIRE STRIPPER | |
|---------------|-------|
| FIG. NO. | PRICE |
| 36468 | |



DOUGLAS HEAVY DUTY PIPE WRENCH/PLIERS
10" long x 2" cap jaw
Jaws angle 90° for 20% more leverage. Pipe wrench style teeth, machined tongue & groove, cushion grips

| FIG. NO. | PRICE |
|----------|-------|
| 60312 | |

SNIPS AND CRIMPERS

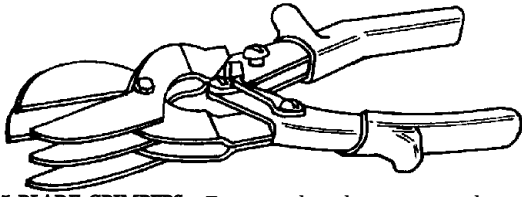

| DESCRIPTION | FIG. NO. | PRICE |
|----------------|----------|-------|
| 5 - BLADE | 16129 | |
| 3-BLADE | 16138 | |
| SINGLE CRIMPER | 16133 | |

5 BLADE CRIMPERS - For easy hand motion and greater control; a superior compound leverage mechanism offers maximum ease of operation, and assures that manual crimps remain accurate over many repetitions. Comfortable opening, spring actuated handles, vinyl cushioned grips, and carefully placed hand stops combine to give you even more comfort and control. Wear resistant hardened steel construction features heavy duty linkage between handles and jaws, plus a closing stop, to maintain the same crimp profile over the file of the tool. Hardened steel also produces greater handle strength to stand up to abusive and resist collapsing. **3 BLADE CRIMPERS** - ideal for crimping heavy 22 and 24 gauge sheet metal. Nickel plated, all steel construction with red vinyl cushion grips. **SINGLE CRIMPER** - fast, easy to use and lightweight. Handy lock makes tool pocket sized. Zinc plated steel. Red grips.

FORGED STEEL SNIPS - Available in regular pattern - for straight cutting and wide curves; and duckbill snips - maneuvers and cuts easily to very tip of blade. Cuts sheet metal, aluminum and steel siding, plastics and other thin materials without tearing or catching.

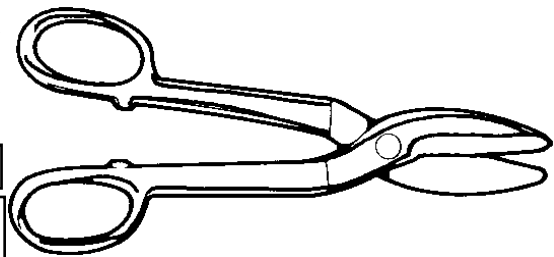

| DESCRIPTION | FIG. NO. | PRICE |
|-------------------|----------|-------|
| REGULAR PATTERN | 16215 | |
| CIRCULAR DUCKBILL | 16213 | |

AVIATION SNIPS - hot drop forged from high carbon alloy steel and fully heat treated for a hard and durable edge. Forged jaws offer superior strength and resistance to fatigue and fracture. The precision ground cutting edges of their jaws hold their sharpness longer and will not slip, even when cutting tight patterns in heavy stock. Machined serrations on the outside face of both cutting edges provide a positive grip on material for a smooth, accurate cut.

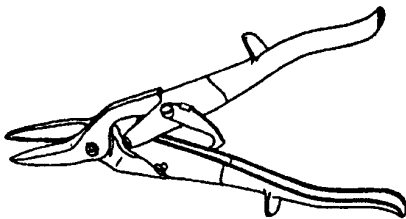

| DESCRIPTION | FIG. NO. | PRICE |
|-------------|----------|-------|
| LEFT HAND | 16143 | |
| RIGHT HAND | 16145 | |
| STRAIGHT | 16147 | |

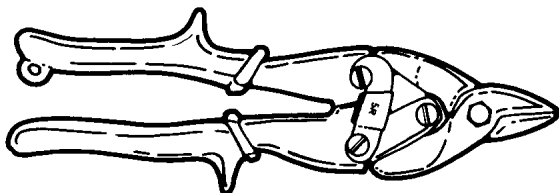

BULLDOG AVIATION SNIPS - Specifically designed for bulldog notching several layers or trimming extra-heavy stock. 18 gauge capacity in Stainless Steel.

| FIG. NO. | PRICE |
|----------|-------|
| 44765 | |

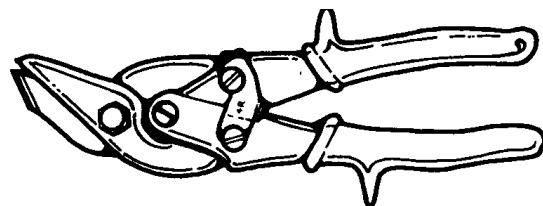

DOUBLE CUT SNIPS - Double cut design is ideal for cutting metal pipe or duct. Double design removes a curled strip of metal from path with virtually no surface distortion. Double cut also features adjustable taper round outer blade. Offset handle design aids maneuverability and also protects user's hands.

| FIG. NO. | PRICE |
|----------|-------|
| 44764 | |

**CALL DUFF FIRST FOR ALL YOUR
TOOL NEEDS!
610-275-4453**

GAS SERVICE TOOLS

ORIFICE DRILLS

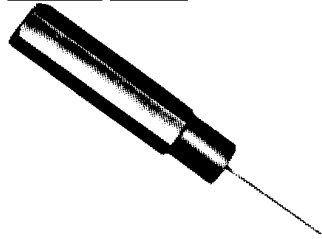

- Drills are permanently bonded into a brass handle no holder is needed.

| FIG. NO. | PRICE |
|----------|-------|
| 50689 | |

SAFETY ANVIL

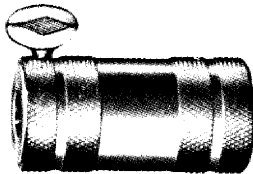

Ideal for holding orifices while drilling or reaming

| FIG. NO. | PRICE |
|----------|-------|
| 50691 | |

REAMER



Ideal for orifices.

| FIG. NO. | PRICE |
|----------|-------|
| 50694 | |

GAS TAP



| FIG. NO. | PRICE |
|----------|-------|
| 50692 | |

ORIFICE DRILL SET

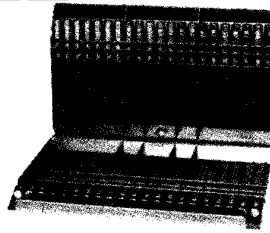

- Packed in a heavy duty case to prevent breakage or falling out
- Set contains 41 drills sizes #40 through #80
- All drills are permanently bonded into a brass handle
- Replacement drills available

| FIG. NO. | PRICE |
|----------|-------|
| 50690 | |

MANOMETER 8" - 0.8"

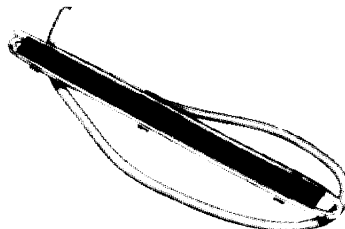

For measuring gas pressure. 0.16 inches water column size. Rubber tubing included.

| FIG. NO. | PRICE |
|----------|-------|
| 50697 | |

PIN VISE



For extra holding while drilling or reaming

| FIG. NO. | PRICE |
|----------|-------|
| 50693 | |

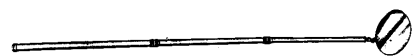

INSPECTION MIRROR with round swivel head

| FIG. NO. | PRICE |
|----------|-------|
| 8893 | |

EXPENDABLE MATCH HOLDER



- Expands from 6" to 24"
- Furnished with pocket clip

| FIG. NO. | PRICE |
|----------|-------|
| 50695 | |

GAS PRESSURE TEST KIT

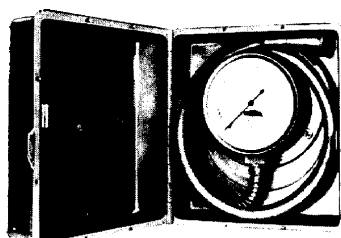

- *0-35 inches water column scale
- *Special nipple for easy connection to any manifold
- *Heavy duty carrying case

| FIG. NO. | PRICE |
|----------|-------|
| 50698 | |

For additional information call: 610-275-4453 or Fax: 610-279-6299
Please call for current prices.



Flange Tool - To install and remove circular flanges.

| FIG. NO. | PRICE |
|----------|-------|
| 72715 | |

GAS TEST GAUGE

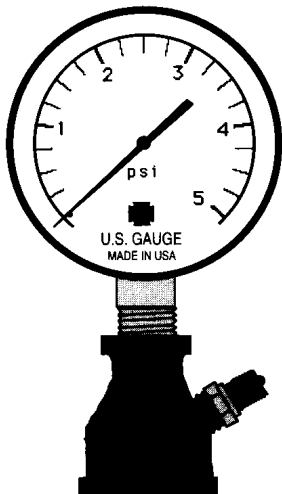

Gas Test Gauge - 2" Face; 0-15 LB; Allows you to pressurize system.

| FIG. NO. | PRICE |
|----------|-------|
| 72716 | |

GAUGE GLASS CUTTER

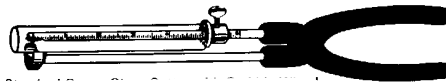

Standard Gauge Glass Cutter with Carbide Wheel for Round Tubular Gauge Glasses.

| FIG. NO. | PRICE |
|----------|-------|
| 17470 | |

SQUEEZE & POP GLASS CUTTER



Cuts cast iron, tile and asbestos cement pipe in seconds with no turning. Cutter chain is wrapped around tubing right at the point where cut is to be made. Any length from 1/2" to several feet may be cut. Cuts up to 3/4" OD.

| FIG. NO. | PRICE |
|----------|-------|
| 17473 | |

PINCH AND CUT GLASS CUTTER

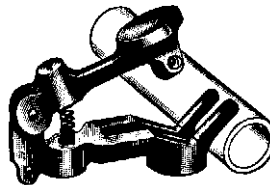

Forged Bronze. For cutting by the rotation of a hardened steel wheel about the outside of a tube of any size not larger than 1-1/8". It employs two V guides to align the tubing at a position normal to the cut. The wheel is held normally open by a coil spring.

| FIG. NO. | PRICE |
|----------|-------|
| 49662 | |

DUFF IS ALWAYS OPEN

**365 DAYS A YEAR
24 HR EMERGENCY SERVICE!**

PINCH OFF TOOL

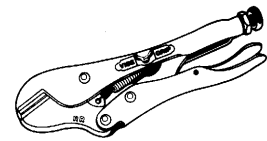

| FIG. NO. | PRICE |
|----------|-------|
| 41063 | |

GRIPZIT

Grip-It strap wrench



Completely adjustable. Urethane covered, high-strength belting attached to lightweight, I-beam handle. Patented "Cam-Action" design permits uniform, high torque application. Ideal for plastic, glass and metal applications.

| FIG. NO. | PRICE |
|----------|-------|
| 58241 | |

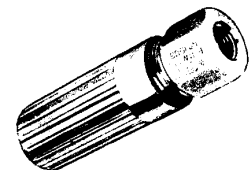

Blow Out Gun - For cleaning oil lines, hydraulic lifts, lub systems, transmission units. Clears blockages with CO2. 1/4 Female connection.

| FIG. NO. | PRICE |
|----------|-------|
| 3797 | |

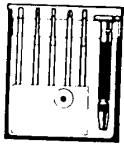

Miniature screwdriver set with swivel handle for delicate jobs.

| FIG. NO. | PRICE |
|----------|-------|
| 50709 | |

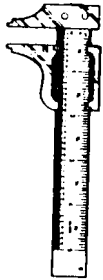

Pocket caliper eliminates the need to remove parts for measurement.

| FIG. NO. | PRICE |
|----------|-------|
| 50707 | |

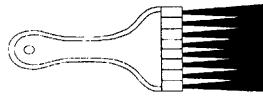

Fin and coil brush. Stiff polypropylene bristles firmly imbedded in plastic handles. Ideal for cleaning inbetween small fins and coils. Small whisk type brush.

| FIG. NO. | PRICE |
|----------|-------|
| 16415 | |



Extra heavy duty fin comb with super sure grip handle for AC coil fins.

| FIG. NO. | PRICE |
|----------|-------|
| 85599 | |



Valve Key.
2" square operator nut x 6'
For municipal water valves.

| FIG. NO. | PRICE |
|----------|-------|
| 67056 | |

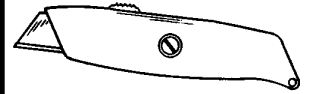

UTILITY KNIFE

| FIG. NO. | PRICE |
|----------|-------|
| 19777 | |

BLADE ONLY (5 PACK)

| | |
|-------|--|
| 42464 | |
|-------|--|

Telescopic magnet for picking up metal objects out of reach.

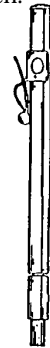

| FIG. NO. | PRICE |
|----------|-------|
| 50706 | |

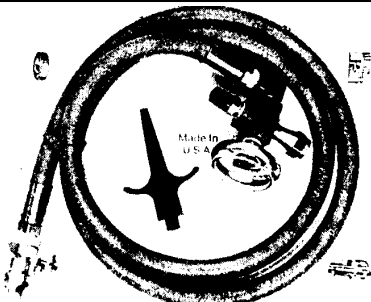

Make Your Own Portable Air Tank

AIR TANK KIT

| FIG. NO. | PRICE |
|----------|-------|
| 50418 | |



PLUMBERS CANDLE

| FIG. NO. | PRICE |
|----------|-------|
| 51061 | |

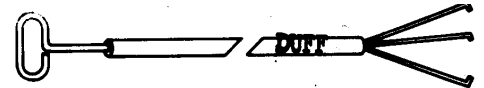

3- PRONG GRAPPLER - For the removal of obstructions from water boxes.

| SIZE | FIG. NO. | PRICE |
|------|----------|-------|
| 8' | 16209 | |
| 6' | 19831 | |



Pocket level with clip great for leveling thermostats. Equipped with handy cutting blade too.

| FIG. NO. | PRICE |
|----------|-------|
| 50710 | |

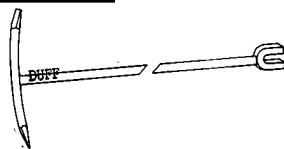

PICK-HANDLE STOP COCK KEY 6'

| FIG. NO. | PRICE |
|----------|-------|
| 16212 | |

MUELLER STYLE

| FIG. NO. | PRICE |
|----------|-------|
| 43540 | |

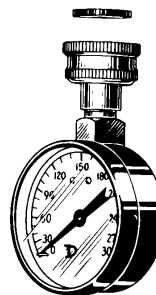

WATER PRESSURE TESTING GAUGE - Accurate and dependable. Used for ascertaining correct water pressure and to determine the proper selection and adjustment of relief valves, regulators, etc. Gauge is 2 1/2" dia. with unbreakable clear plastic crystal. Finished in black, with standard hose connection at top - the spud fitted with pressure reducing bushing. 0 lbs. to 300 lbs.

WATER PRESSURE TESTING GAUGE

| FIG. NO. | PRICE |
|----------|-------|
| 3695 | |

SAWS

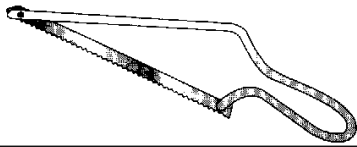

| "TEENY WEENY" MIDGET FRAME AND BLADE | |
|--|-------|
| FIG. NO. | PRICE |
| 39909 | |
| 10 PACK, 6-INCH MIDGET BLADES. WAVY SET BLADE WITH FLEXIBLE BACK AND HARD TEETH. SMOOTH, RAPID CUTTER. REMOVES VERY LITTLE STOCK IN CUTTING. | |
| FIG. NO. | PRICE |
| 39910 | |

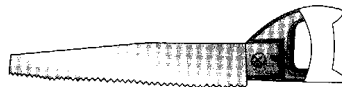

| SQUARE TIP PVC SAW | |
|--------------------|-------|
| FIG. NO. | PRICE |
| 18" | 38148 |
| 12" | 48993 |
| BLADE ONLY | |
| FIG. NO. | PRICE |
| 18" | 38149 |
| 12" | 48996 |

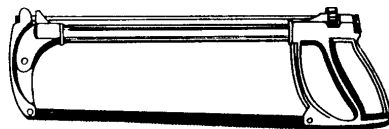

RIDGID

| RIDGID MASTER GRIP FRAME HACK SAW WITH TENSION WHEEL | |
|--|-------|
| FIG. NO. | PRICE |
| 13635 | |
|  LENOX BRAND MODEL 4012 | |
| FIG. NO. | PRICE |
| 48995 | |

PVC CABLE SAW

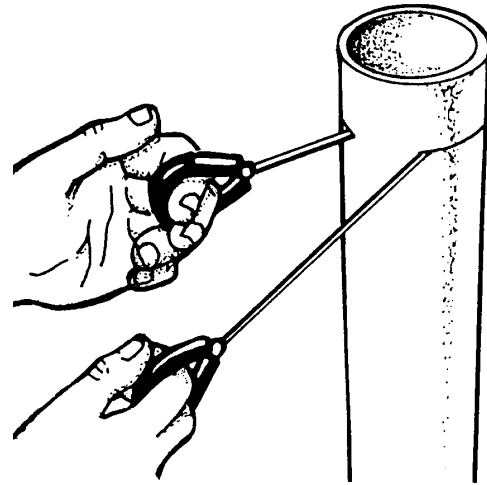

| PVC CABLE SAW | |
|---------------|-------|
| FIG. NO. | PRICE |
| 49240 | |

HACK SAWS

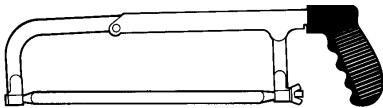

| STANDARD FRAME HACK-SAW | |
|-------------------------|-------|
| FIG. NO. | PRICE |
| 44696 | |

IF YOU DON'T SEE IT... JUST ASK US!

Milwaukee HACKSAW BLADES

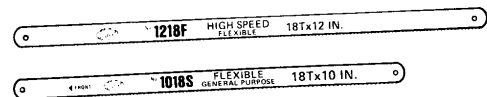

| DESCRIPTION | FIG. NO. | PRICE |
|------------------|----------|-------|
| 12" 10 pak 14tpi | 30728 | |
| 12" 10 pak 18tpi | 30729 | |
| 12" 10 pak 24tpi | 30730 | |

MINISAW - For hard to get to spots



| FIG. NO. | PRICE |
|----------|-------|
| 16149 | |

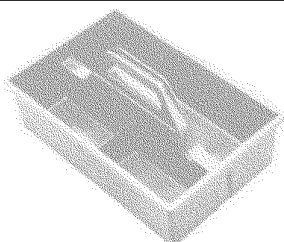

TOOL TOTE - Crush proof, heavy duty tote tray, ideal for carrying tools and supplies to jobsite. made of tough polypropylene, long wearing, rust proof, portable and lightweight. Three compartments to accommodate tools and supplies. Comfortable handle-grip - will not bite into palm of hand. 10"W X 15"L X 4 1/2" D.

| FIG. NO. | PRICE |
|----------|-------|
| 38088 | |

PVC TOOLS

DEBURRING TOOL

For plastic pipe and tubing. Quickly removes inside burrs and outside ridges. Tool is applied to the outer or inner surface of the cut end of pipe or tubing and twisted under pressure. Result, a neatly chamfered or reamed end. High grade steel with specially designed cutting edges. Vinyl cushion hand grip.

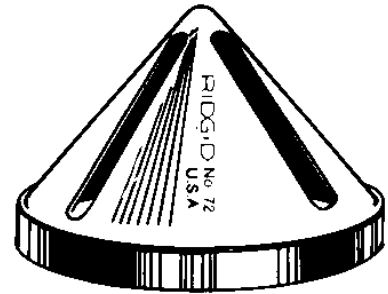

| DESCR | FIG. NO. | PRICE |
|-----------|----------|-------|
| 1/2-1 1/2 | 13140 | |
| 1 1/2 - 3 | 83968 | |
| 4 | 83967 | |

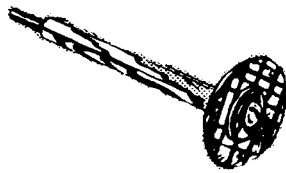

PVC INSIDE PIPE CUTTER

Cuts 2" and larger pipe.

| FIG. NO. | PRICE |
|----------|-------|
| 35990 | |

PVC NIPPLE EXTRACTOR

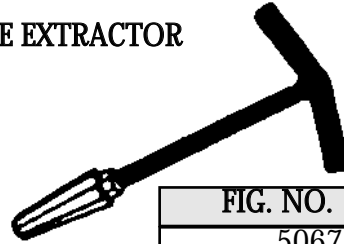

| FIG. NO. | PRICE |
|----------|-------|
| 50673 | |

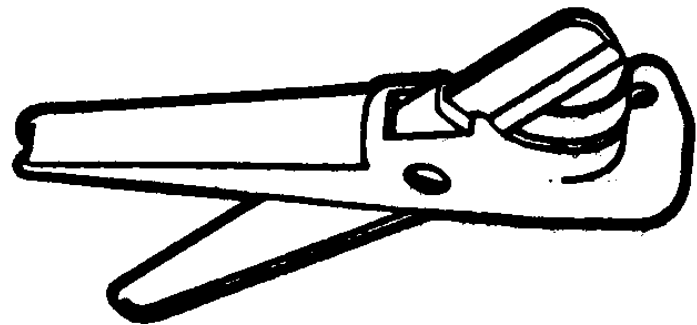

LI'L AND BIG NIPPERS

These cutters do not distort the pipe allowing insert fitting to slide into flexible pipe easier - and allow cement fittings to slide onto rigid pipe as easily as possible.

| PIPE SIZE | FIG. NO. | PRICE |
|-----------|----------|-------|
| 1/2" - 1" | 17480 | |
| 1" - 2" | 50467 | |

WORKS ON:

ABS DWV *PVC DWV *PVC PRESSURE *Rigid PVC Electrical Conduit *Schedule 40 and 80 *Class 125, 160 and 200 *All sizes fit 3/8" power drill *Works with a heavy duty, cordless 3/8" rechargeable drill *Fits common drill bit extensions.

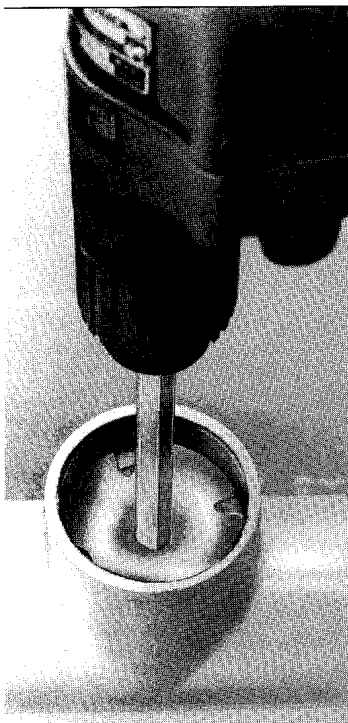

| FIG. NO. | SIZE | CL 125 | CL 200 | SCH 40 | SCH 80 | DRILL SIZE | PRICE |
|----------|--------|--------|--------|--------|--------|------------|-------|
| 49650 | 1/2" | X | | X | X | 3/8" or | |
| 49651 | 3/4" | X | X | X | X | heavy duty | |
| 49652 | 1" | | X | X | X | 3/8" | |
| 49653 | 1 1/4" | | X | X | X | recharge- | |
| 49654 | 1 1/2" | | X | X | X | able | |
| 49655 | 2" | | X | X | X | | |
| 50704 | 3" | | X | X | | 1/2" | |
| 50705 | 4" | | | X | | variable | |



PIPE EXTRACTORS

RIDGID pipe extractors make easy work of removing broken threaded ends of pipe, pipe plugs, fittings, etc. Each is plainly marked showing drill size used when solid ends of plugs and fittings must be drilled to receive extractor.

I N D I V I D U A L E X T R A C T O R S

| OEM # | SIZE | FIG. NO. | PRICE |
|-------|-------|----------|-------|
| 86E | 1 1/4 | 35117 | |
| 87E | 1 1/2 | 13651 | |
| 89E | 2 | 35119 | |

S E T S

| DESCRIPTION | SIZES | FIG. NO. | PRICE |
|-------------------------|-------|----------|-------|
| Nos. 81 to 85 inclusive | 1/4-1 | 28650 | |
| Nos. 80 to 85 inclusive | 1/8-1 | 28651 | |

PIPE - N - HOT

Pipe Thawer No more Blowtorches!

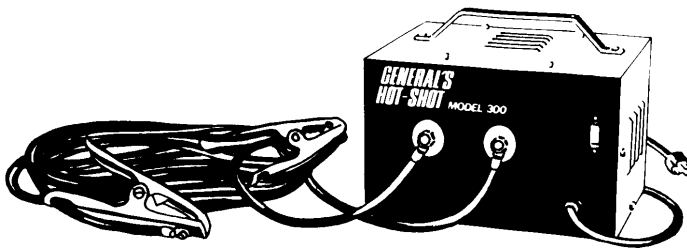

Portable - 115 Volt - sturdy low voltage output - circuit breaker protected - guaranteed for 2 years.

| DESCRIPTION | FIG. NO. | PRICE |
|------------------------------------|----------|-------|
| 300 AMP Thawing machine less cable | 9157 | |
| CABLES ONLY | | |
| 20 FEET | 9158 | |
| 50 FEET | 9159 | |

INTERNAL PIPE WRENCH



Tool to remove nipples. Eccentric action grips inside of pipe.

| SIZE | FIG. NO. | PRICE |
|----------|----------|-------|
| 3/8 | 16224 | |
| 1/2 | 16225 | |
| 3/4 | 16227 | |
| 1 | 16228 | |
| SET OF 4 | 40720 | |

TAPS



Carbon Steel right hand pipe taps. High quality, made in USA

| SIZE | FIG. NO. | PRICE |
|-------|----------|-------|
| 1/8 | 12975 | |
| 1/4 | 12977 | |
| 3/8 | 12978 | |
| 1/2 | 12980 | |
| 3/4 | 12983 | |
| 1 | 12985 | |
| 1 1/4 | 12986 | |
| 1 1/2 | 12988 | |
| 2 | 12990 | |
| 2 1/2 | 12992 | |
| 3 | 17154 | |
| 3 1/2 | 35354 | |
| 4 | 17156 | |



VAN & TRUCK RACKS

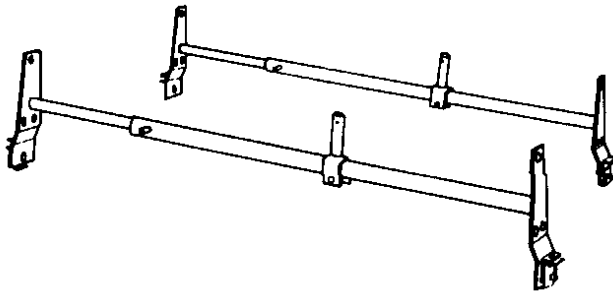

Van racks for drip moldings; Clamps to drip molding and adjusts to various van widths. No drilling necessary. Fitted with ladder positioners.

| MAKE OF TRUCK | YEAR | FIG. NO. | PRICE |
|--|------|----------|-------|
| Chevrolet, Dodge, Ford, Dodge-Caravan, Jeep Wagoneer, Toyota-Cargovan, Volkswagon-Vanagon, Isuzu Trooper, Mitsubishi Montero, Land Cruiser, Raider, Nissan Van | ALL | 50767 | |

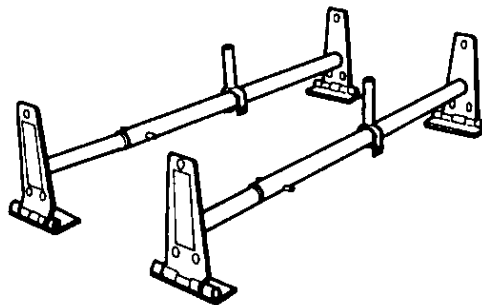

Van Rack without drip moldings; Features telescoping bar which adjusts to any width.

| MAKE OF TRUCK | YEAR | FIG. NO. | PRICE |
|--|------|----------|-------|
| Chevy-Astro, S-10 Blazer, GMC-Safari, S-15 Jimmy, Ford Aerostar, Bronco II | ALL | 50768 | |
| Chev. & GMC- Blazer, Jimmy, Suburban, Ford Bronco, Dodge Ram Charger | ALL | 50769 | |

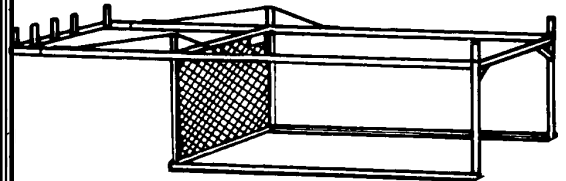
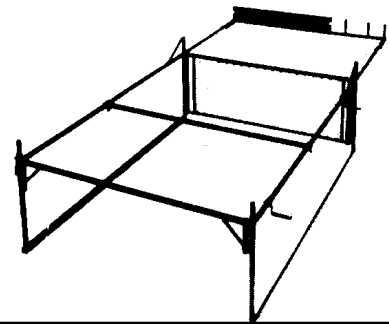
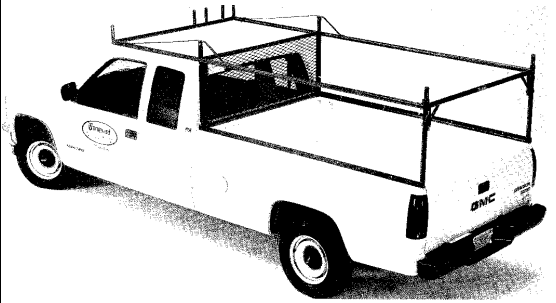

| Make of Truck | Year | Model No. |
|---|-------------|-----------|
| Chev. GMC/Long - Wide - Full Size (Model C&K Only) | *88 thru 94 | TCR 6799 |
| Chev. GMC/Short - Wide - Full Size (Model C&K Only) | *88 thru 94 | TCR 6780 |
| Chev. GMC/Long - Wide - Full Size | Up thru 87 | TCR 7099 |
| Chev. GMC/Short - Wide - Full Size | Up thru 87 | TCR 7080 |
| Chev. GMC/Long - Narrow - Full Size (Sportside) | Up thru 87 | TCR 5499 |
| Chev. GMC/Short - Narrow - Full Size (Sportside) | 88 thru 94 | TCR 5480 |
| Chev. S-10, Long GMC - S-15, Long | Up thru 93 | TCR 5890 |
| Chev. S-10, Long GMC - S-15, Long | 1994 | TCR 6290 |
| Chev. S-10, Short GMC - S-15, Short | Up thru 93 | TCR 5874 |
| Chev. S-10, Short GMC - S-15, Short | 1994 | TCR 6274 |
| Dodge/Long-Wide - Full Size | Up thru 93 | TCR 7099 |
| Dodge/Long-Wide - Full Size | 1994 | TCR 6999 |
| Dodge/Short-Wide - Full Size | Up thru 93 | TCR 7080 |
| Dodge/Short-Wide - Full Size | 1994 | TCR 6980 |
| Dodge Dakota/Long | 87 thru 94 | TCR 6099 |
| Dodge Dakota/Short | 87 thru 94 | TCR 6080 |
| Dodge Ram-50/Long | 87 thru 93 | TCR 5890 |
| Dodge Ram-50/Short | 87 thru 93 | TCR 5874 |
| Ford/Long-Wide - Full Size | Up thru 94 | TCR 7099 |
| Ford/Short-Wide - Full Size | Up thru 94 | TCR 7082 |
| Ford/Short-Narrow - Full Size (Flareside) | 1993 - 1994 | TCR 5480 |
| Ford Ranger/Long | Up thru 94 | TCR 5886 |
| Ford Ranger/Short | Up thru 94 | TCR 5874 |
| Jeep Comanche/Long | 86 thru 94 | TCR 6090 |
| Jeep Comanche/Short | 87 thru 94 | TCR 6074 |
| Isuzu/Long | 88 thru 94 | TCR 6090 |
| Isuzu/Short (including space cab model) | 88 thru 94 | TCR 6074 |
| Isuzu/Long | 83 thru 87 | TCR 5890 |
| Isuzu/Short | 83 thru 87 | TCR 5874 |
| Mazda/Long | 86 thru 94 | TCR 6090 |
| Mazda/Short | 86 thru 94 | TCR 6074 |
| Mitsubishi/Long | 87 thru 94 | TCR 5890 |
| Mitsubishi/Short | 87 thru 94 | TCR 5874 |
| Nissan/Datsun Long | 86 thru 94 | TCR 5890 |
| Nissan/Datsun Short | 86 thru 94 | TCR 5874 |
| Toyota/Long | 84 thru 94 | TCR 5986 |
| Toyota/Short | 84 thru 94 | TCR 5974 |
| Toyota T100 | 1993 - 1994 | TCR 6699 |

For additional information call: 610-275-4453 or Fax: 610-279-6299
Please call for current prices.

LADDERS

FIBERGLASS STEP LADDERS

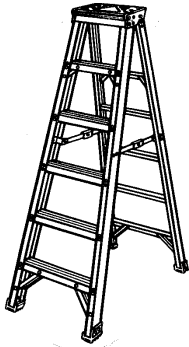

Fiberglass heavy duty industrial yellow stepladder.

| SIZE | FIG. NO. | PRICE |
|-------|----------|-------|
| 6 FT | 50758 | |
| 8 FT | 50759 | |
| 10 FT | 50760 | |

FIBERGLASS EXTENSION LADDERS

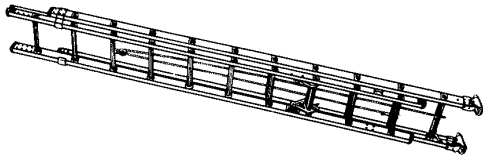

- Orange non-conductive fiberglass siderails.
- Black non-marring, polycarbonate end caps.
- External guides on top of base section and internal guides on bottom of fly section.
- Large, smooth-operating, extruded gravity/spring locks with spring activated nylon flipper.
- Polyethylene rung wear sleeves.
- Heavy duty aluminum extruded pulley.
- Extruded aluminum shoe with steel spur plate.
- Pre-pierced holes at top of fly for field installation of accessories.

| Total Length | Overlap | Ext. Length | Fig. No. | Price |
|--------------|---------|-------------|----------|-------|
| 16 FT | 3 FT | 13 FT | 50755 | |
| 24 FT | 3 FT | 21 FT | 50756 | |
| 28 FT | 3 FT | 25 FT | 50757 | |

ALUMINUM STEP LADDERS

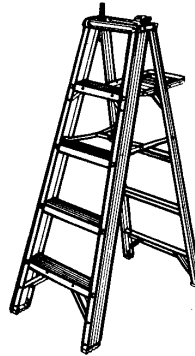

Aluminum commercial stepladders.

| SIZE | FIG. NO. | PRICE |
|-------|----------|-------|
| 6 FT | 50763 | |
| 8 FT | 50764 | |
| 10 FT | 50765 | |

ALUMINUM EXTENSION LADDERS

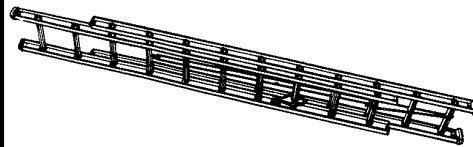

Aluminum commercial extension ladders.

| Total Length | Overlap | Ext. Length | Fig. No. | Price |
|--------------|---------|-------------|----------|-------|
| 24 FT | 3 FT | 21 FT | 50761 | |
| 28 FT | 3 FT | 25 FT | 50762 | |

YEATS APPLIANCE DOLLY PARTS

| OEM # | DESCRIPTION | FIG. NO. |
|-------|-------------------------------|----------|
| F1 | Top Handle | 15950 |
| F1A | Top Handle | 15952 |
| F2 | Side Member LEFT | 15954 |
| | RIGHT | 15956 |
| F11 | Side Member LEFT | 15952 |
| | RIGHT | 15959 |
| F13 | Side Member LEFT | 15961 |
| | RIGHT | 15963 |
| F17 | Side Member LEFT | 15966 |
| | RIGHT | 15968 |
| F19 | Side Member LEFT | 15971 |
| | RIGHT | 15973 |
| F6 | Cross Member | 15982 |
| F3 | Cross Bar, complete | 15975 |
| F4 | Cross bar bolt | 15979 |
| F28 | Side handle | 15996 |
| F20 | Cross member latch w/ bracket | 15984 |
| F21 | Web strap support rod | 15987 |
| F24 | Axle | 15990 |
| F25 | Nose Plate (lip) | 15992 |
| | | 15993 |
| R31 | Ratchet handle w/ spring | 16006 |
| R32 | Ratchet return spring | 16007 |
| R33 | Latch w/ bracket & spring | 16008 |
| R30 | Latch arm & spring | 16005 |
| R34 | Latch spring | 16009 |
| R36 | Strap shaft w/ cog | 16011 |
| R37 | Cog wheel w/ pin | |
| 16012 | | |
| R35 | Dolly strap (web strap) | 16010 |
| R38 | Strap clamp holder | 16013 |
| S41 | Slide belt | 16018 |
| S40 | Slide slide | 16017 |
| S39 | Top pulley | 16016 |
| S42 | Lower pulley | 16019 |
| W51 | Roller bearing wheel | 16020 |
| W52 | Wheel bearing w/ sleeve | 16021 |
| W53 | Casters (accessory) | 16023 |
| P81 | Felt pads w/ cement #5 | 16068 |
| P82 | Felt pads w/ cement #7 | 16069 |
| P83 | Felt pads w/ cement #9 | 16075 |
| P84 | Felt pads w/ cement #14 | 16077 |

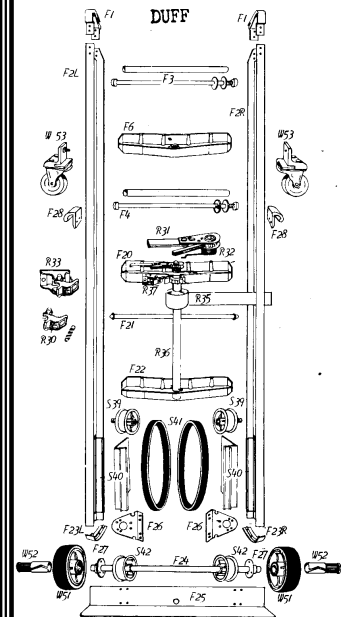

For additional information call: 610-275-4453 or Fax: 610-279-6299.
Please call for current prices.

MATERIAL HANDLING



MAGNESIUM APPLIANCE TRUCKS

Entire frame including nose and top handles is magnesium
 Frame is constructed of heavy wall 5" magnesium I beam
 Fully welded for maximum strength - outlasts other light metal designs.
 5" deep x 24" wide magnesium nose plate.
 Overall width 24" frame width 17".
 .625" ball bearing wheels.

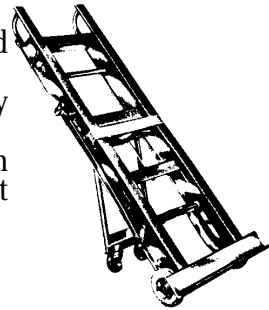

MRV-66-EC

MRC

| DESCR | FIG. NO. | PRICE |
|---------|-----------|-------|
| MRC | DCMRC | |
| MRV66EC | DCMRV66EC | |

DELUXE SERIES PALLET TRUCKS

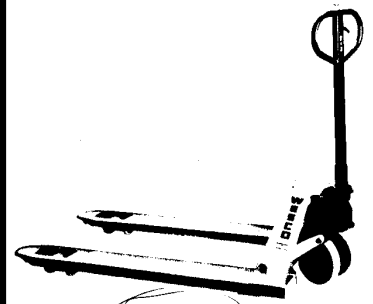

One year warranty on hydraulics for low trouble, low cost service
 Safety loop handle for easier handling
 Triple function hand control (raise, neutral, lower) maneuvers easily in any position.
 Spring loaded handle automatically returns to vertical position
 200° steering angle for extra maneuverability in tight areas.

CHAIN HOIST



- High quality yet economical hoists in capacities to 5 tons.
- Available in 10 and 20 foot lifts.
- Hardened load chain for long life.
- Low headroom for easy installation in tight areas.
- Lubrication free load brake for positive load control.
- Swivel hooks with latches on all models.
- Portable for easy use in a wide variety of applications.

Specifications

| FIG. NO. | Capacity | Lift | Approx. Weight | Distance Hook to Hook | Chain Pull to Lift Rated Load | Hand Chain Overhaul for 1' Lift |
|----------|------------|-------|----------------|-----------------------|-------------------------------|---------------------------------|
| C163 | 1000 lbs | 10 ft | 19 1/2 lbs | 9.5" | 50 lbs | 30 ft |
| C164 | 2000 lbs | 10 ft | 24 lbs | 10.6" | 70 lbs | 38 ft |
| C165 | 3000 lbs | 10 ft | 35 1/2 lbs | 13.75" | 80 lbs | 59 ft |
| C166 | 4000 lbs | 10 ft | 33 lbs | 15" | 70.6 lbs | 80 ft |
| C167 | 6000 lbs | 10 ft | 52 lbs | 18.5" | 82.5 lbs | 135 ft |
| C168 | 10,000 lbs | 10 ft | 81 1/2 lbs | 23.6" | 90 lbs | 160 ft |
| C169 | 1000 lbs | 20 ft | 31 1/2 lbs | 9.5" | 50 lbs | 30 ft |
| C170 | 2000 lbs | 20 ft | 35 1/2 lbs | 10.6" | 70 lbs | 38 ft |
| C171 | 3000 lbs | 20 ft | 52 1/2 lbs | 13.75" | 80 lbs | 59 ft |
| C172 | 4000 lbs | 20 ft | 50 lbs | 15" | 70.6 lbs | 80 ft |
| C173 | 6000 lbs | 20 ft | 76 1/2 lbs | 18.5" | 82.5 lbs | 135 ft |
| C174 | 10,000 lbs | 20 ft | 117 1/2 lbs | 23.6" | 90 lbs | 160 ft |



EASY REACH

TO CLEAR DRAINS, GUTTERS, ETC. REACHES OUT OF REACH PLACES!

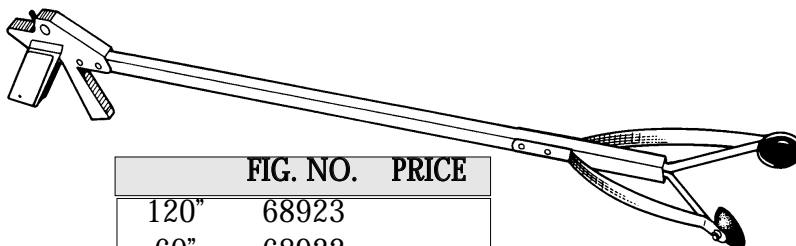

| FIG. NO. | PRICE |
|----------|-------|
| 120" | 68923 |
| 60" | 68922 |



For additional information call: 610-275-4453 or Fax: 610-279-6299
 Please call for current prices.

MATERIAL HANDLING

STEEL APPLIANCE TRUCKS

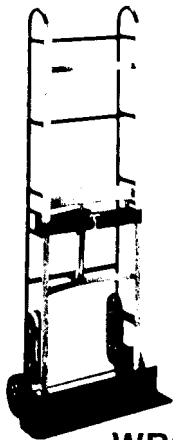

ALL MODELS fully welded for maximum strength including magnesium line. New "auto-rewind" ratchet design. Non-marking long lasting grey vinyl on all contact surfaces. WESCO Caterpillar Crawler Stair Climbers on all models. 2" wide heavy duty web belt on all models. Rugged tubular steel construction All joints double welded for maximum durability. Aluminum center moldon rubber wheels with .625 ball bearing. Overall height 59" width 24" frame width 17".

WRC

STEEL APPLIANCE TRUCKS

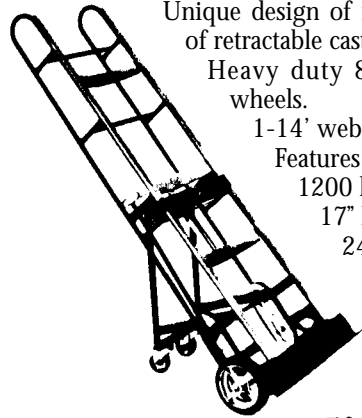

Unique design of release handle allows control of retractable caster from standing position. Heavy duty 8" diameter roller bearing wheels. 1-14" webl belt. Features ratchet with rewind. 1200 lbs. 17" Frame 24" Nose 14.5" overall depth 86 lbs. approx weight.

WRV-66

| DESCR | FIG. NO. | PRICE | DESCR | FIG. NO. | PRICE |
|-------|----------|-------|-------|----------|-------|
| WRC | DCWRC | | WRV66 | DCWRV66 | |

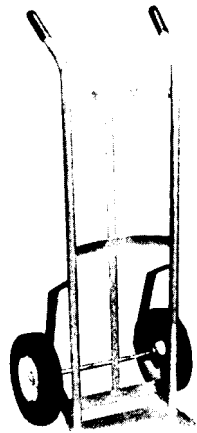

Two handle tapered body design Three extra heavy horizontal cross bars, with center strap 48" overall height 15" frame width 500 lbs. capacity 10" x 2.75" semi-pneumatic 41 lbs. approximate weight

| DESCR | FIG. NO. | PRICE |
|-------|----------|-------|
| 136Z | DC136Z | |

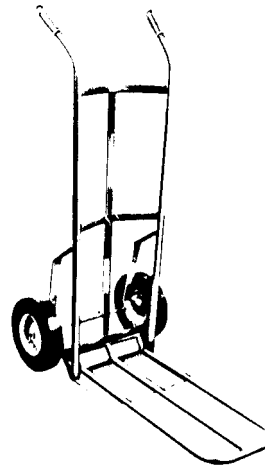

FOLDING NOSE ACCESSORY

Order factory installed or add later to all model

| DESCR | FIG. NO. | PRICE |
|-------|----------|-------|
| FN24 | DCFN24 | |

HEAVY DUTY 2-IN-1 TRUCKS

Extra high 55.5 overall height Wheel guards Ball bearing wheels 8" deep x 14" wide beveled nose plate Extra long 45.5" bed Comfortable 44" high push handle Extra straps to minimize package fall through. 600 lbs. 10"x2.75 Semi-pneumatic.

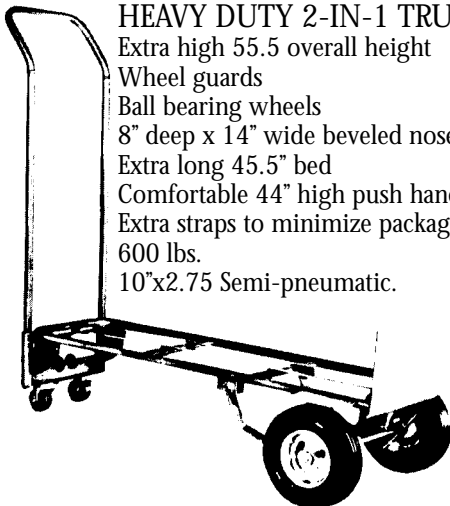

| DESCR | FIG. NO. | PRICE |
|---------|----------|-------|
| 156-S21 | DC156S21 | |

HEATER HAULER

One person hand truck heater hauler makes removal clean and easy! Facilitates removal of water heaters up to 80 gallon (250 lb). Heavy duty nylon elimiantes damage to floors and carpets.



| FIG. NO. | PRICE |
|----------|-------|
| 73932 | |

POWER DRAIN CLEANER COMPARISON CHART

| Model | Typical applications | For use in following pipe sizes | Maximum capacity | Maximum recommended distance | Operating weight | Motor horsepower |
|-----------------------|---|---|---|---|--|------------------------------------|
| Super-Vee | Sinks, bathtubs, roof stacks | 1¼"–3" 30 mm–75 mm | 35 ft. x ¾" or 50 ft. x 5/16" 10.5 m x 9.5 mm or 15 m x 7.9 mm | 50 ft. 15 m | 16 lbs. with 25 ft. x 3/8" 7 kg | 2.7 amp. |
| Mini-Rooter | Small drains, inside work, on roofs (not for roots) | 1¼" thru 3" and most 4" 30 mm thru 75 mm and most 100 mm | 75 ft. x ½" 22.5 m x 12.7 mm | 75 ft. 22.5 m | 51 lbs. with 75 ft. x ¾" 23 kg | ½ hp. |
| Sewerooter T-3 | Same as Mini-Rooter | 1¼" thru 3" and most 4" 30 mm thru 75 mm and most 100 mm | 100 ft. x ½" 30 m x 12.7 mm | 100 ft. 30 m | 105 lbs. 48 kg | ½ hp. |
| Maxi-Rooter | Heavy duty, roots, sand, industrial plants | 3"–10" 75 mm–250 mm | 125 ft. x ¾" 38 m x 19 mm | 200 ft. 60 m | 250 lbs. 114 kg | ¾ hp. |
| Sewermatic 100 | Same as Maxi-Rooter | 3"–10" 75 mm–250 mm | 50 ft. x ¾" or 75 ft. x ¾" 15 m x 19 mm or 22.5 m x 15.8 mm | 200 ft. 60 m | 168 lbs. with 50 ft. x 3/4" 76 kg | ¾ hp. |
| Speedrooter 90 | Combination Sewerooter T-3 and Maxi-Rooter | 2"–10" 50 mm–250 mm | 100 ft. x ¾" 30 m x 19 mm | 200 ft. 60 m | 239 lbs. 108 kg | ½ hp. |
| Rodrunner | Heavy duty, roots, sand, industrial plants | 3"–10" 75 mm–250 mm | Not Applicable | 200 ft.* 60 m | 90 lbs. without sections 41 kg | ¾ hp., 1 hp., or 5 hp. Gas Eng. |
| Model 82 | Same as Rodrunner | 3"–10" 75 mm–250 mm | Not Applicable | 200 ft. 60 m | 80 lbs. without sections 36 kg | ½ hp. or ¾ hp. |
| Root 66 | Small drains, inside work, on roofs (not for roots) | 1¼" thru 4" 30 mm thru 100 mm | Not Applicable | 100 ft. x ¾" cable 30m x 15.8 mm 125 ft. x 7/8" cable 38 m x 22.4 mm | 38 lbs. without sections 17 kg | ½ hp. |
| Jet Set | Grease, sand, soft stoppages, and ice. | 1½" thru 8" 38 mm thru 203 mm | Up to 300 ft. depending upon unit. | 75 ft. x ½" hose, 22.5m x 3.2 mm 200 ft. x ¼" hose, 60m x 6.4 mm 300 ft. x ¾" hose, 90m x 9.5 mm | Varies with unit. | 1½ hp. to 16 hp. |

*300 ft. (90 m) with 1 hp. motor; 500 ft. (150 m) with gas engine.



CALL TODAY FOR YOUR PRICING AND AVAILABILITY!

DUFF COMPANY IS YOUR BEST SOURCE FOR GENERAL WIRE MACHINES AND EQUIPMENT!

GENERAL WIRE DRAIN CLEANERS

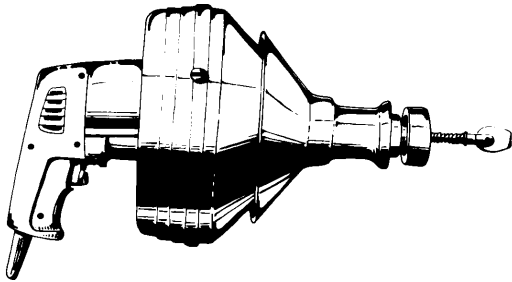

Slide action chuck, Vari-speed motor with reversing switch, plastic cartridge, case, 25 ft. x 1/4", 35 ft x 3/8" cables, cutter set and 1 additional cartridge.

| OEM NO. | FIG. NO. | PRICE |
|---------|----------|-------|
| SV-C-WC | 15528 | |

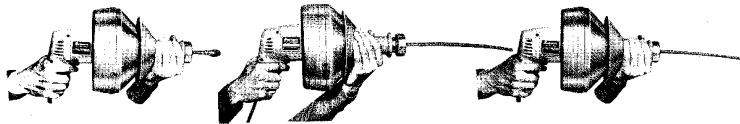

REPLACEMENT CABLES

| OEM NO. | SIZE | DESCR. | FIG. NO. | PRICE |
|----------|----------|-------------------------|-----------------------|-------|
| 25HE1 | 1/4"X25' | With EL basin plug head | With Female Connector | 15537 |
| 50HE1 | 1/4"X50' | With EL basin plug head | | 15538 |
| 25HE1-DH | 1/4"X25' | With down head | | 15539 |
| 50HE1-DH | 1/4"X50' | With down head | | 15540 |
| 25HE2 | 3/8"X25' | | | 15546 |
| 35HE2 | 3/8"X35' | With Female Connector | | 15547 |

SUPERVEE CUTTER SET

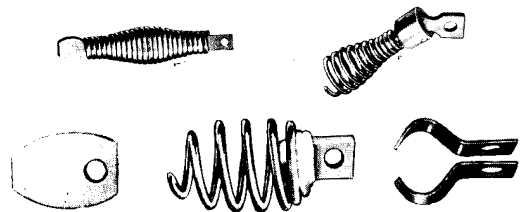

| OEM NO. | FIG. NO. | PRICE |
|---------|----------|-------|
| HE-CS | 15529 | |

HEAVY DUTY AUGERS

15/32" OD DOUBLE LAYER FLEXICORE CONSTRUCTION



DOWNHEAD

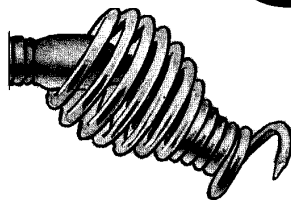

| DOWNHEAD | | | |
|-------------------------|---------|----------|-------|
| DESCR. | OEM NO. | FIG. NO. | PRICE |
| 3 ft flexicore | 3FL-DH | 15798 | |
| 6 ft teletube flexicore | T6FL-DH | 20245 | |

REGULAR HEAD



| REGULAR HEAD | | | |
|-------------------------|---------|----------|-------|
| DESCR. | OEM NO. | FIG. NO. | PRICE |
| 3 ft flexicore | 3FL | 15804 | |
| 6 ft teletube flexicore | T6FL | 20246 | |

OPERATORS GLOVE

| DESCR. | FIG. NO. | PRICE |
|------------|----------|-------|
| Left Hand | 19094 | |
| Right Hand | 19095 | |



GENERAL WIRE DRAIN CLEANERS

DRAIN ROOTER



The drain rooter is a real labor-saver on long jobs or when working in a cramped area where the weight of the machine could get burdensome. The drum speed can be varied by changing pressure on the foot pedal, and a quick change drum system lets you switch to a different diameter cable in seconds. Of course, the cables are super-tough Flexicore with a wire rope center.

| OEM NO. | DESC. | FIG. NO. | PRICE |
|---------|---|----------|-------|
| DR-C | DRAIN ROOTER UNIT WITH 35 FT. X 3/8" CABLE AND CUTTER SET | DCGDRC | |
| DR-F | DRAIN ROOTER UNIT WITH 25 FT. X 1/4" CABLE | DCGDRF | |

SPEEDROOTER 90

1/2 HP capacity motor, large drum, ground fault interrupter, water-proof air foot switch, leather gloves, one 100 ft x 5/8" cable and cutter set. Boxed wt. 220 LBS.

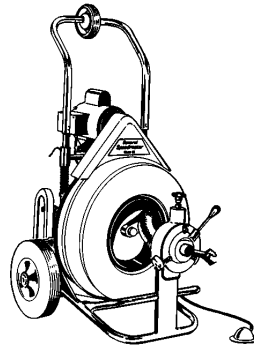

| OEM NO. | FIG. NO. | PRICE |
|---------|----------|-------|
| GPS90E | 15694 | |

SNAKE OIL

SNAKE-OIL protects your snakes better than common lubricants. Its special rust inhibitor cuts through moisture and replaces it with a rust-resistant coating. In addition, the lemon-scented SNAKE-OIL give your equipment a fresh, clean smell.



| SIZE | FIG. NO. | PRICE |
|------|----------|-------|
| QT | 15593 | |
| GAL | 15599 | |

FLAT SEWER RODS

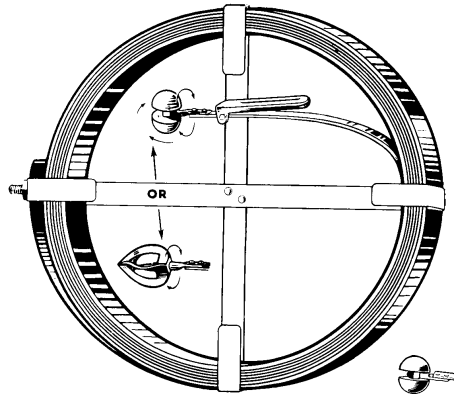

A sturdy tool for cleaning waste pipe and sewers.

- * Oil tempered spring steel - won't kink; rust-ban coating
- * Rod is bolted to holder at end so it can't spring out.
- * Quick-grip handle makes the work go faster.

| SIZE | FT. | OEM NO. | FIG. NO. | PRICE |
|---------------------------|-----|---------|----------|-------|
| 1/4"x1/16" Small pipe | 25 | 25A | 15811 | |
| | 50 | 50A | 15812 | |
| 1/2"x1/16" Medium pipe | 50 | 50B | 15814 | |
| | 75 | 75B | 15816 | |
| | 100 | 100B | 15818 | |

LARGE ECONOMY

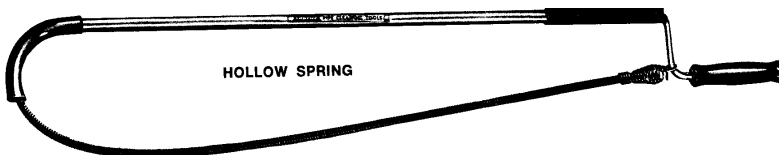

Equipped with 1/2" diameter galvanized spring. Wood turning handle and vinyl grip handle; vinyl bowl guard; 3/4" plated steel tube; 3/8" galvanized steel turning rod. Has ring for holding spring in place when not in use.

| OEM NO. | FIG. NO. | PRICE |
|---------|----------|-------|
| 3J | 49320 | |

ECONOMY DRAIN CLEANER

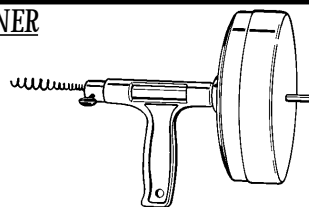

Cables are 1/4" Economy Grade Models

| DESCR. | OEM NO. | FIG. NO. | PRICE |
|--------------|---------|----------|-------|
| 15 ft x 1/4" | R-15SM | 15787 | |
| 25 ft x 1/4" | R-25SM | 15789 | |

For additional information call: 610-275-4453 or Fax: 610-279-6299
Please call for current prices.

GENERAL WIRE DRAIN CLEANERS

MINIROOTER

GMRB - With 75 ft x 3/8" cable (75 EM2) and minirooter cutter set.

GMRC - with 50 ft. x 1/2" cable (50EM3) and minirooter cutter set.

J50 - J-drum with 50 ft x 1/4" cable (50HE) installed (no machine)

J50A - J-drum with 50 ft x 5/16" cable (50HE-A) installed (no machine).

ACCESSORIES:

MR200 - Drum for 3/8" or 1/2" cables.

MR250 - J-drum for 1/4" or 5/16" cables.

MR280 - Dual drum for small diameter cables.

REPLACEMENT CABLES:

| | | | |
|-----------------|-------------|---------------|------------|
| 50HE1: | 1/4" X 50' | 75EM2: | 3/8" X 75' |
| 50HE1-A: | 5/16" X 50' | 50EM3: | 1/2" X 50' |
| 50EM2: | 3/8" X 50' | 75EM3: | 1/2" X 75' |

MR-W - Mini rooter dolly.

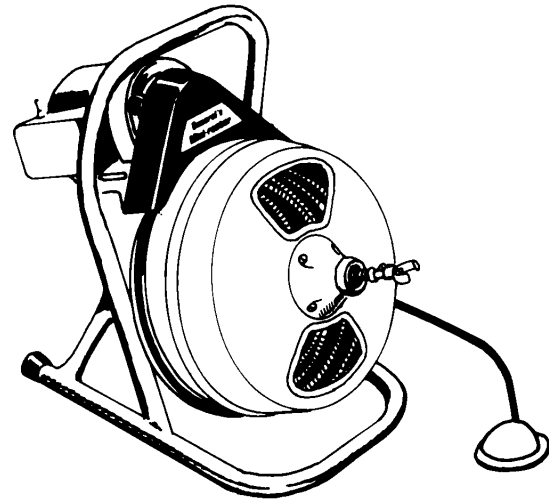

DUAL DRUM
(MR-280)

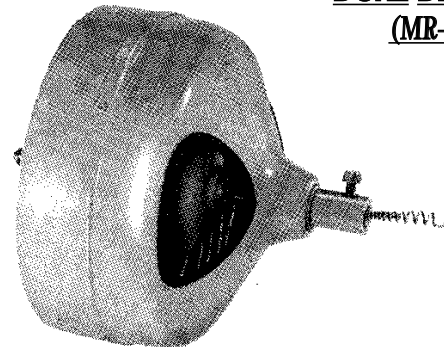

J DRUM
(MR-250)

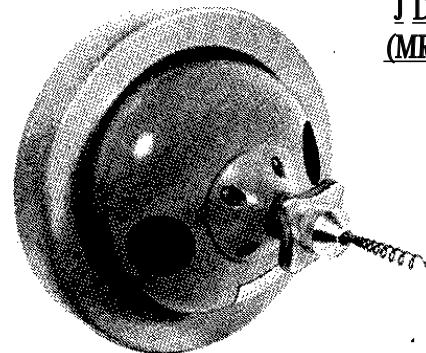

DOLLY

| OEM NO. | FIG. NO. | PRICE |
|---------|----------|-------|
| GMRB | 15558 | |
| GMRC | 15559 | |
| J50 | DCGJ50 | |
| J50A | DCGJ50A | |
| MR200 | 15562 | |
| MR250 | DCGMR250 | |
| MR280 | DCGMR280 | |
| 50HE1 | 15538 | |
| 50HE1A | 15542 | |
| 50EM2 | DCG50EM2 | |
| 75EM2 | 39065 | |
| 50EM3 | 30865 | |
| 75EM3 | 37793 | |
| MRW | DCGMRW | |

GENERAL WIRE DRAIN CLEANERS

ROOT 66

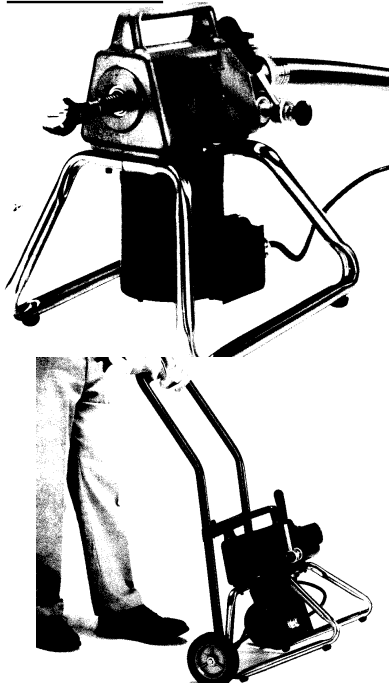

- RT66A** - With six 7.5 R8 sections, an SCC cable carrier and R-8CS cutter set. (Boxed WT 72 LBS).
- RT66B** - Same as RT66A, plus drum with 25' x 5/16" cable installed. (Boxed WT82 LBS).
- RT66C** - With five 15R10 sections, a CC cable carrier an R-10CS cutter set and a tool box. (Boxed WT 143 LBS).
- RT66D** - Combines units A and C. (Boxed WT 143 LBS).
- RT66E** - Same as D, plus drum with 25' x 5/16" cable installed. (Boxed WT 153 LBS)

REPLACEMENT CABLE:



- 75R8** - 5/8" X 7 1/2' openwound...3 LBS.
- 15R10** - 7/8" X 15' openwound.....10 LBS.

CUTTER SETS:

R8CS cutter set includes: Boring Gimlet, 1 1/2" U Cutter, Retrieving Tool, Arrow Head Coupling Key.

R10CS cutter set includes: Spear Head, Hook Auger, 2" U cutter, 3" U Cutter, retrieving tool, coupling key.

66W - Dolly for the ROOT 66.

RAH - Arrow Head.

RBG - Boring Gimlet for removing loose object.

R11/2UC 1 1/2" U Cutter for cutting and scraping.

RRTR1 Corkscrew retrieving tool for removing loose objects.



| OEM NO. | FIG. NO. | PRICE |
|---------|----------|-------|
| RT66A | 50734 | |
| RT66B | 50735 | |
| RT66C | 50736 | |
| RT66D | 50737 | |
| RT66E | 50738 | |
| R8CS | 50739 | |
| R10CS | 50742 | |
| 7.5R8 | D75RS | |
| 15R10 | D15R10 | |
| 66W | 72427 | |

BACK SUPPORT

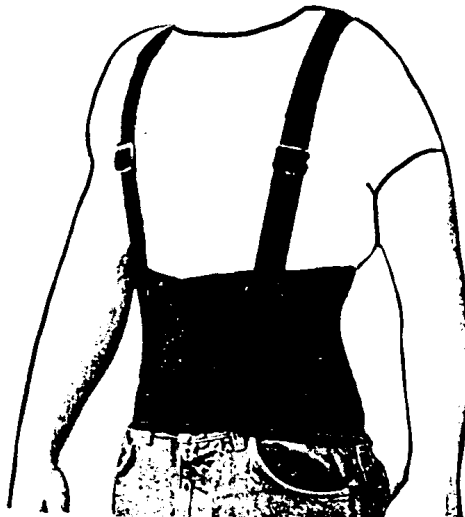

Back Injuries are America's #1 Occupational Health Hazard

- 20 - 25% of compensated work injuries are back injuries
- Back injuries cost \$18 - 23,000 per incidence (50% direct costs, remainder in lost time)
- 95% of all back injuries are due to repetitive stresses...not a single heavy lift
- OSHA estimates that back injuries alone now cost \$16,000,000,000 per year
- Back pain or injury is the cause for an estimated 40% of work absences
- Yearly 400,000 - 450,000 U.S. workers sustain a debilitating back injury
- Back injuries are growing at a rate of 15 - 20% per year
- According to U.S. Department of Labor, 48% of all recordable industrial work place illness is due to repetitive disorders

Professional quality comfort and support.

- Elastic binding allows the body of the support to stretch providing the wearer with a more exact fit.
- Front closure by means of hook and loop fasteners.
- Can be worn loosely when support is not needed.
- Two 4" side pulls attach in front providing superior intra-abdominal support.
- Woven suspenders are guaranteed not to fray
- Four spring steel vinyl coated stays prevent "roll-over".
- Griptex stay pockets hold the belt in position.

PROTECT YOURSELF AND YOUR COMPANY!

| SIZING | |
|-------------|-----------|
| BELT SIZE | WAIST |
| Large | 37" - 41" |
| X-Tra Large | 41" - 45" |

| SIZE | FIG. NO. | PRICE |
|------|----------|-------|
| L | 51049 | |
| XL | 51050 | |

For additional information call: 610-275-4453 or Fax: 610-279-6299
Please call for current prices.

GENERAL WIRE DRAIN CLEANERS

RODRUNNER:

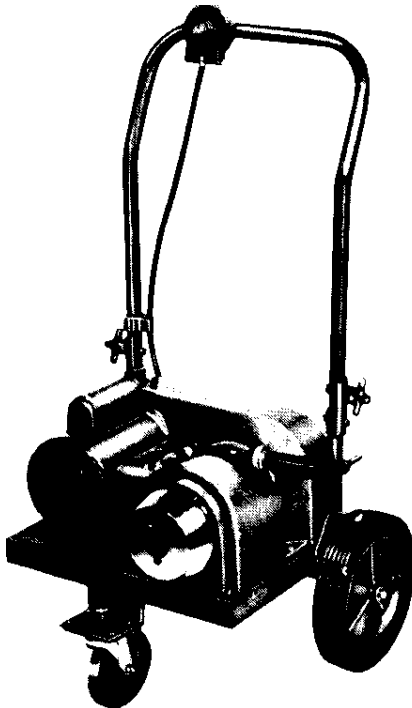

GRDGF - With ten flexichain sections with "G" connectors, and RCDS-G cutter set.

GRDGP - With ten proflex sections with "G" connectors, and RDCS-G cutter set.

GRDLF - With ten 10LF flexichain flexible sections with "L" connectors, and RDCS-L cutter set.

GRDLP - with ten 10LP proflex sections with "L" connectors and RDCS-L cutter set.

RDCS-G Rodrunner cutter set with "G" connectors includes: Spear head, Hook Auger, 2" U Cutter, 3" Heavy Duty Side Cutter, 3" Heavy duty Saw Blade, 4" Rotary Saw Blade, Large Retrieving Tool, Coupling Wrench.

RDCS-L Rodrunner cutter set with "L" connectors includes: Spear Head, Hook Auger, 2" U Cutter, 3" Heavy Duty Side cutter, 3" Heavy Duty Saw Blade, 4" Rotary Saw Blade, Large Retrieving Tool, Coupling Wrench.

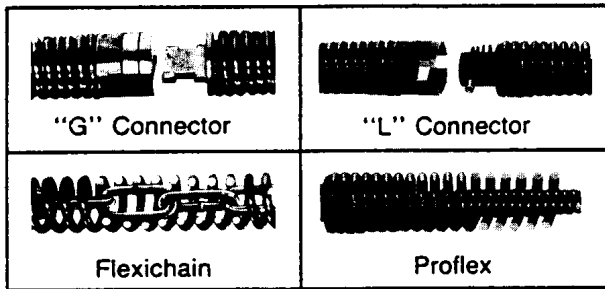

| OEM NO. | FIG. NO. | PRICE |
|---------|----------|-------|
| G-RD-GF | 15761 | |
| G-RD-GP | 15763 | |
| G-RD-LF | 15765 | |
| G-RD-LP | 15766 | |
| RDCS-G | 15767 | |
| RDCS-L | 15769 | |

CUTTER SETS

RSHD10
Spear Head



R2UC10 -
2" U-Cutter
for cutting
and scrap-
ing.



R3UC10 -
3" U-Cutter
for cutting
and scrap-
ing.



RRTR10 -
Corkscrew
retrieving
tool for
removing
loose
objects.



RHA10 - Hook Auger
for breaking up stop-
page and retrieving.

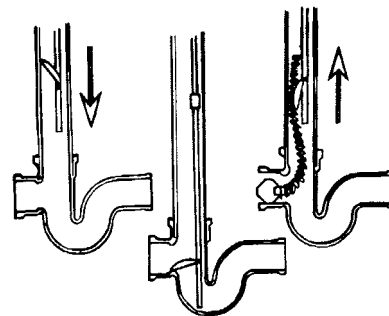

TRAP SPOON

Guides tool into pipe. Ideal for lawn or curb traps.

| OEM NO. | FIG. NO. | PRICE |
|---------|----------|-------|
| 59440 | 25035 | |

JET DRAIN CLEANERS



GENERAL J14500 ELECTRIC JET

Equipped with vibrapulse for hard corners.
 Compact and easy to use.
 Reel is detachable in seconds.
 Telescoping handle.
 1 1/2 HP motor.
 1500 psi.
 1.7 gpm.
 Comes with 75' hose.



GENERAL J3000 GAS JET

Also used for pressure washing
 13 HP Honda engine.
 Complete with 200 FT hose.
 Great for large lines and long runs.
 3000 psi - 4 gpm

CR-300 CART-REEL

The optional cart-Reel is a must for professionals. It lets you use the power of a gas jet in building and confined spaces where exhaust fumes could be hazardous, while the gas jet stays outside. The Cart-Reel comes with pneumatic tires, a 300 ft. capacity hose reel, reel brake, gauge and shut-off valve.



RIDGID SEE SNAKE DIAGNOSTIC TOOLS

For precise, easy video inspection of 2" to 10" drain, conduit, and utility lines. These high performance, durable camera/transmitter systems allow for exact diagnosis of line problems in all type of industries. Whether it's a root-impacted, collapsed, or bellied drain line, a jammed conduit line, or a damaged chimney, the patent pending SeeSnake unit identifies the problem and allows the operator to diagnose the correct solution.

**CALL DUFF
 NOW
 FOR PRICING
 AND
 AVAILABILITY!
 610-275-4453**

RIDGID DRAIN CLEANERS

UP TO 2 1/2" CAPACITY



- Excellent for small line cleaning. Opens clogged lavatory, sink lines, urinals, and tub/shower drains.
 - 5/16" cables best for 3/4" to 1 1/2" lines.
 - 3/8" cables best for 1 1/4" to 2 1/2" lines.
- Available in 3 styles: corded slide action chuck, corded 3 jaw chuck, and cordless slide action chuck.
 - Chuck styles allow for quick locking/releasing of cable.
- Lightweight, easy-to-use, no set up required.
- Variable speed 1/2" ball bearing power unit rotates cable 0-550 rpm's.
- Two piece canister with interchangeable inner drum.
 - Makes cable changeout simple; easy to match the right cable to the job.
 - Gasket prevents water leaks.
 - Captive screws prevent hardware loss.
 - Drums won't rust or dent – ever.
- Drum Capacity: 50' of 5/16" (15m/8mm) or 35' of 3/8" (11m/10mm).
- UL listed and CSA approved.

| FIG. NO. | MODEL NO. | DESCRIPTION | PRICE |
|----------|-----------|---|-------|
| 35184 | K-39 | Machine with: -C11C, 5/16"x25' inner core cable with inner drum, C-6, 3/8" x 35' cable with inner drum, T-250, five piece tool set for 3/8, cable, C-6429 carrying case | |

UP TO 4" CAPACITY

Model K-50 – For 3/4" to 4" (19-100mm) Drain Lines



- Compact, versatile, professional's machine. Capable of running three different size cables: 5/16", 3/8", and 5/8". The perfect, all-around sink, shower, and floor drain machine. Weighs less than 35 lbs.
- Unique, easy-to-use, instant-acting cable clutch maximizes operator control:
 - Pull handle down and cable spins at 400 RPM.
 - Release handle, cable stops – instantly.
- Uses sections of 5/8" cable, cleans 1 1/4" to 4" lines up to 100 feet.
 - C-8 best for 1 1/4-3" drains.
 - C-9 best for 2-4" drains.
- Equipped with an A-17 adapter, runs up to 50 feet of 5/16" (15m/8mm) or 35 feet of 3/8" (11m/10mm) continuous length cable.
 - 5/16" best for 3/4" to 1 1/2" lines.
 - 3/8" best for 1 1/4" to 2" lines.
- Equipped with 1/6 HP motor; 115V Models CSA approved.

| FIG. NO. | MODEL | DESCR | PRICE |
|----------|-------|--------------|-------|
| 19097 | K-50 | MACHINE ONLY | |



**CALL DUFF FOR AVAILABLE CABLES, TIPS AND KITS!
610-275-4453**

RIDGID DRAIN CLEANERS

UP TO 4" CAPACITY



ASK ABOUT ACCESSORIES

Model K-3800 – For 3/4" to 4" (19-100mm) Drain Lines

- A powerful, easy to transport, versatile machine for cleaning indoor drains. Requires minimal set-up to clean sink lines, floor drains, roof vents.
- Rugged, corrosion-resistant molded cable drum won't dent or rust. The drum tilt-adjusts for proper cable feed angle. Inner-drum guards against cable flip-over.
- Cable drum's quick-release and built-in hand-holds allow easy cable size changes and balanced, two-handed transport.
- Standard drum capacity is 100' of 3/8" or 90' of 1/2" (30m/10mm or 27m/12mm) continuous length cable:
 - 3/8" cable best for 1 1/2" to 3" lines up to 100'.
 - 1/2" cable best for 2" to 4" lines up to 90'.
- Optional sink drum holds up to 50' of 5/16" or 1/4" (15m/8mm) cable.
 - Ideal for cleaning through 3/4" to 1 1/2" sink traps.
- Powerful 1/12 HP Universal Motor spins cable at 240 RPM max. When cable hits blockage, motor gears down automatically to deliver more power, enhance operator control.
- Tools snap connect to cable in seconds.
- CSA Approved

| FIG. NO. | MODEL | DESCR | PRICE |
|----------|--------|--------------|-------|
| 86081 | K-3800 | MACHINE ONLY | |



RIDGID

Model K-60SP – For 1 1/4" to 4" (32-100mm) Drain Lines

- A compact machine for institutional, commercial or residential cleaning. Also ideal for septic tank, vacuum truck operators. Small enough to fit into cramped spaces, yet powerful enough to clear tough blockages.
- Ideal for roof-top vent stacks. Rear handle allows for easy transporting up ladders and onto roof tops.
- Unique, easy-to-use instant-acting cable clutch maximizes operator control.
 - Push handle down, cable spins at 600RPM
 - Release handle, cable frees instantly, no overrun to kink or damage cable.
- Simple adjustment knob allows unit to spin both 7/8" (22mm) and 5/8" (16mm) diameter cable. Adjusts in seconds.
 - 7/8" cable (C-10) cleans 2" to 4" lines through 150 feet.
 - 5/8" cable (C-7, C-8, C-9) cleans 1 1/4" to 4" lines through 125 feet.
- Remove only two bolts to access jaw set for cleaning or replacement. Removal of same bolts provides access to belt drive.
- Equipped with 1/2 HP motor.

| FIG. NO. | MODEL | DESCR | PRICE |
|----------|--------|--------------|-------|
| 19098 | K-60SP | MACHINE ONLY | |

CALL DUFF FOR AVAILABLE CABLES, TIPS AND KITS!

RIDGID DRAIN CLEANERS

UP TO 4" CAPACITY



Model K-75 – For 1 1/4" to 4" (32-100mm) Drain Lines

- Offers many features of heavier-duty K-1500 Machine in a lighter-weight design. Speed cleans drain lines. Easy to transport; sets up fast.
- Unique, easy-to-use instant-acting cable clutch maximizes operator control:
 - Pull handle down, cable spins at 640 RPM.
 - Release handle, frees cable instantly, no overrun.
- Equipped to spin easy-to-handle 15-foot sections of 7/8" (4,6m/22mm) cable to clean 2" to 4" lines through 175 feet (50-100mm/53m).
- Change clutch jaws to run 7 1/2-foot sections of 5/8" (C-8, C-7, C-9) cable to clean 1 1/4" to 4" lines through 125 feet (32-75mm/38m).
- Equipped with 1/2 HP motor; CSA approved.

NOTE: Available in both upright "A" and low-profile "B" frame styles.

| FIG. NO. | MODEL | DESCR | PRICE |
|----------|-------|--------------|-------|
| 35246 | K-75 | MACHINE ONLY | |



UP TO 10"



Model K-1500SP – For 2" to 10" (50-250mm) Drain/Sewer Lines

- All the features of the standard K-1500 with extra power to clean larger lines (10") and longer distances (through 300 feet). Cuts through blockages fast.
- Equipped with full 1 HP TEFC motor and heavy-duty rotary switch.
- Unique easy-to-use instant-acting cable clutch maximizes operator control:
 - Pull handle down and cable spins at 600 RPM.
 - Release, frees cable instantly, no overrun to loop or break cable.
- Low-profile "B" frame design will fit most crawl spaces.
- 10" semi-pneumatic ball bearing wheels.
- Easy clutch jaw change-out adapts the K-1500 SP to use 7/8" cable to clean 2" to 4" lines through 175 feet (order jawset A-368X, 59325).

| FIG. NO. | MODEL | DESCR | PRICE |
|----------|--------|--------------|-------|
| 86174 | K-1500 | MACHINE ONLY | |

CALL DUFF FOR AVAILABLE CABLES, TIPS AND KITS!

UP TO 10" CAPACITY RIDGID DRAIN CLEANERS



Model K-750 – For 3" to 10" (75-250mm) Drain/Sewer Lines

- Powerful, self-contained machine ideal for lateral lines. Easy-to-transport, minimal set-up – attach a tool and go.
- Powerfeed advances, retrieves cable automatically, up to 20' per minute.
- Versatile powerfeed adjusts for either 5/8" or 3/4" cable with a twist of a screwdriver.
 - Recommend 5/8" cable for 3" to 6" drain lines up to 200' (75-150mm, 62m).
 - Recommend 3/4" cable for 4" to 10" drain lines up to 200' (100-250mm, 62m).
- Tough, corrosion-resistant cable drum withstands harsh treatment, abuse. It will not dent or corrode and cleans easily.
- Drum holds 100 feet of 3/4" (30m, 19mm) or 125 feet of 5/8" (35m, 16mm) cable and is designed for quick, easy removal.
- Well-balanced design gives machine a light-weight "feel." Transport wheel eases loading into service truck/van.
- Equipped with 1/2 HP induction motor. 115V Models CSA approved.

| FIG. NO. | MODEL | DESCR | PRICE |
|----------|-------|--------------|-------|
| 86079 | K-750 | MACHINE ONLY | |



Model K-7500 – For 3" to 10" (75-250mm) Drain/Sewer Lines

- The performance, cable control, durability, and maneuverability demanded by professional users. Ideal for any tough job, such as roots – up to 250'.
 - Recommend 5/8" cable for 3" to 6" drain lines up to 250' (75-150mm, 76m).
 - Recommend 3/4" cable for 4" to 10" drain lines up to 250' (100-250mm, 76m).
- Powerful, yet quiet, 4/10 Hp universal motor and gearbox bear down as cutter engages tough obstructions.
 - Provides audible and visual signal to operator.
- Inner-drum and ball bearing distributor arm work with motor/gearbox system to reduce chance of cable flip-over.
- Main and inner drums won't rust, split, or dent – ever, and clean easily for professional appearance. Main drum holds up to 125' of 3/4" cable or 150' of 5/8" cable.
- Powerful feed mechanism has grease fittings and an open design for easy maintenance; advances and retrieves cable up to 22' per minute.
- Patented two position stair climber eases transport and loading – eliminates extra cost for loading wheels.
- Narrow profile allows machine to fit through bathroom doors.
- Handles adjust to desired height to ensure balanced transport.
- CSA Approved

| FIG. NO. | MODEL | DESCR | PRICE |
|----------|--------|--------------|-------|
| 86232 | K-7500 | MACHINE ONLY | |



CALL DUFF FOR AVAILABLE CABLES, TIPS AND KITS!

ELECTRICAL TESTERS AND TOOLS

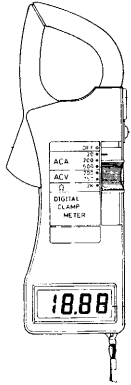

AMPROBE
LCD Digital Readout..

| FIG. NO. | PRICE |
|----------|-------|
| 64154 | |

TESTERS



Voltage sensor with audio and visual indicators. No need to make contact for reading!

| FIG. NO. | PRICE |
|----------|-------|
| 50713 | |

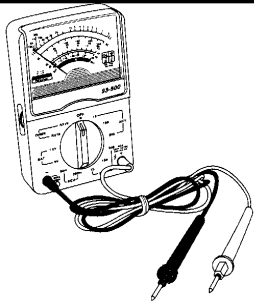

93-500 Analog Multimeter

This analog multimeter offers the key functions required in a multi tester. AC /DC voltage, resistance, DC current, decibels, and a battery check are easily read on the 3-color mirrored scale. Recessed lead connections and fuse protection provide important safety features.

| FIG. NO. | PRICE |
|----------|-------|
| 64154 | |

Handy combination Hi-voltage tester and pocket screwdriver with a range of 90 to 250V AC/DC, clips on shirt pocket.

| FIG. NO. | PRICE |
|----------|-------|
| 50715 | |

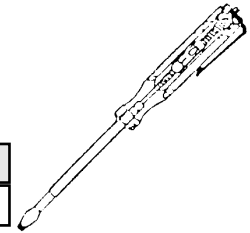

Detects AC voltage from 100 to 440 VAC

| FIG. NO. | PRICE |
|----------|-------|
| 50714 | |

MAGNETIC SOLENOID/COIL TESTER



| FIG. NO. | PRICE |
|----------|-------|
| 50716 | |



PVC ELECTRICAL TAPE - A high quality all-purpose black vinyl 7 1/2 mil. electrical tape. 3/4" x 60".

| FIG. NO. | PRICE |
|----------|-------|
| 15332 | |

4 way voltage tester with indicator lights for 110, 220, 277 & 480V AC/DC and features flexible leads and pocket clip.

| FIG. NO. | PRICE |
|----------|-------|
| 50717 | |



AUTOMOTIVE BOOSTER CABLES - All premium grade cables come with heavy duty vinyl clad clamps with gator-jaws. Heavy insulated, copper stranded wire. Tangle free cables.

| FIG. NO. | PRICE |
|----------|-------|
| 43542 | |

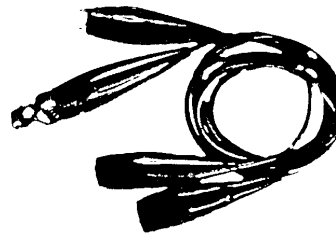

Jumper leads are 36' in length with alligator clips & plastic insulators to cover metal clips.

| FIG. NO. | PRICE |
|----------|-------|
| 50718 | |

INDUSTRIAL FLASHLIGHTS

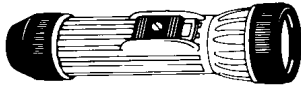

Standard flashlight

| FIG. NO. | PRICE |
|----------|-------|
| 39283 | |

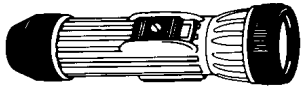

Flashlight with magnet

| FIG. NO. | PRICE |
|----------|-------|
| 35356 | |

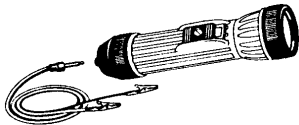

Flashlight with continuity tester

| FIG. NO. | PRICE |
|----------|-------|
| 39284 | |

BATTERIES



AA Alkaline battery 3pak

| FIG. NO. | PRICE |
|----------|-------|
| 42615 | |



Powershot industrial battery lasts 7 times longer than ordinary zinc carbon D-cells. Excellent low/high temperature use; longer shelf life, better leak resistance; open dated for freshness. Replaced individual D-cells; helps eliminate batter pillerage. 2 cell.

| FIG. NO. | PRICE |
|----------|-------|
| 39285 | |

EXTENSION CORDS

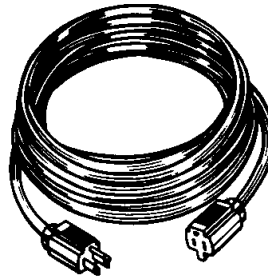

Outdoor extension cord set. Vinyl cover will not mar floors or walls and resists deterioration. Three conductor, grounded cord sets - UL (USA) - round - meets OSHA requirements. Double insulation around each conductor, plus a heavy outer jacket in mar-proof orange vinyl. Heavy duty molded on plastic male and female plugs.

| GA/COND | LGTH/FT | 125 V RATING | FIG. NO. | PRICE |
|---------|---------|--------------|----------|-------|
| 16/3 | 25 | 20A | 43559 | |
| 16/3 | 50 | 20A | 16195 | |
| 16/3 | 100 | 15A | 44766 | |

TROUBLE LIGHTS

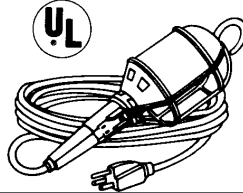

Trouble lights - UL (USA) - Three conductor with extension outlets. Deluxe trouble light with grounded three wire outlet on easy grip handle. Socket housings are designed to stay cool even when short neck bulbs are used. Ground metal bulb cage and hook. On/Off switch.

| GA/COND | LGTH/FT | 125 V RATING | FIG. NO. | PRICE |
|---------|---------|--------------|----------|-------|
| 16/3 | 25 | 13A | 43560 | |
| 16/3 | 50 | 13A | 16197 | |

ROUGH SERVICE BULBS

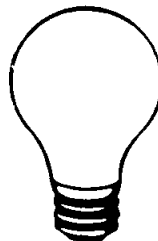

Rough Service Light Bulbs - brass base to eliminate corrosion in the socket, making replacement easier. Designed to burn for 5,000 hours - most competitors offer a 2,000 hour bulb at comparable pricing.

| FIG. NO. | PRICE |
|----------|-------|
| 46946 | |

DUCT WORK NYLON STRAPS AND TENSIONING TOOL

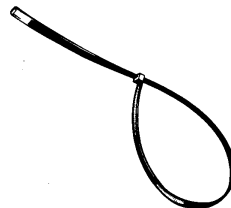

Bramec nylon straps - one piece, self-locking, adjustable design with no metal parts. No special tools required. Control final tension and cut off by using Fig. No. 50684 tension tool. This nylon meets UL94-v-2 flammability classification. Approved for clamping many types of flexible air ducts listed under UL 181, class 1. 45 1/2" long for 14" duct.

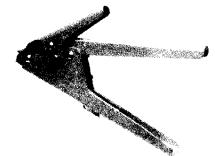

Highly durable, light and handy tool that operates with one hand. It fits all standard and heavy-duty ties. Provides proper tightness and the excess material is trimmed flush.

| FIG. NO. | PRICE |
|----------|-------|
| 50683 | |

| FIG. NO. |
|----------|
| 50684 |

DECIMAL AND MILLIMETER EQUIVALENTS

| | DECIMALS | MILLIMETERS |
|-----------------|----------|-------------|
| $\frac{1}{64}$ | 0.015625 | 0.397 |
| $\frac{1}{32}$ | .03125 | 0.794 |
| $\frac{3}{64}$ | .046875 | 1.191 |
| $\frac{1}{16}$ | .0625 | 1.588 |
| $\frac{5}{64}$ | .078125 | 1.984 |
| $\frac{3}{32}$ | .09375 | 2.381 |
| $\frac{7}{64}$ | .109375 | 2.778 |
| $\frac{1}{8}$ | .1250 | 3.175 |
| $\frac{9}{64}$ | .140625 | 3.572 |
| $\frac{5}{32}$ | .15625 | 3.969 |
| $\frac{11}{64}$ | .171875 | 4.366 |
| $\frac{3}{16}$ | .1875 | 4.763 |
| $\frac{13}{64}$ | .203125 | 5.159 |
| $\frac{7}{32}$ | .21875 | 5.556 |
| $\frac{15}{64}$ | .234375 | 5.953 |
| $\frac{1}{4}$ | .2500 | 6.350 |
| $\frac{17}{64}$ | .265625 | 6.747 |
| $\frac{9}{32}$ | .28125 | 7.144 |
| $\frac{19}{64}$ | .296875 | 7.541 |
| $\frac{5}{16}$ | .3125 | 7.938 |
| $\frac{21}{64}$ | .328125 | 8.334 |
| $\frac{11}{32}$ | .34375 | 8.731 |
| $\frac{23}{64}$ | .359375 | 9.128 |
| $\frac{3}{8}$ | .3750 | 9.525 |
| $\frac{25}{64}$ | .390625 | 9.922 |
| $\frac{13}{32}$ | .40625 | 10.319 |
| $\frac{27}{64}$ | .421875 | 10.716 |
| $\frac{7}{16}$ | .4375 | 11.113 |
| $\frac{29}{64}$ | .453125 | 11.509 |
| $\frac{15}{32}$ | .46875 | 11.906 |
| $\frac{31}{64}$ | .484375 | 12.303 |
| $\frac{1}{2}$ | .5000 | 12.700 |

1 mm = .03937"

| | DECIMALS | MILLIMETERS |
|-----------------|----------|-------------|
| $\frac{33}{64}$ | 0.515625 | 13.097 |
| $\frac{17}{32}$ | .53125 | 13.494 |
| $\frac{35}{64}$ | .546875 | 13.891 |
| $\frac{9}{16}$ | .5625 | 14.288 |
| $\frac{37}{64}$ | .578125 | 14.684 |
| $\frac{19}{32}$ | .59375 | 15.081 |
| $\frac{39}{64}$ | .609375 | 15.478 |
| $\frac{5}{8}$ | .6250 | 15.875 |
| $\frac{41}{64}$ | .640625 | 16.272 |
| $\frac{21}{32}$ | .65625 | 16.669 |
| $\frac{43}{64}$ | .671875 | 17.066 |
| $\frac{11}{16}$ | .6875 | 17.463 |
| $\frac{45}{64}$ | .703125 | 17.859 |
| $\frac{23}{32}$ | .71875 | 18.256 |
| $\frac{47}{64}$ | .734375 | 18.653 |
| $\frac{3}{4}$ | .7500 | 19.050 |
| $\frac{49}{64}$ | .765625 | 19.447 |
| $\frac{25}{32}$ | .78125 | 19.844 |
| $\frac{51}{64}$ | .796875 | 20.241 |
| $\frac{13}{16}$ | .8125 | 20.638 |
| $\frac{53}{64}$ | .828125 | 21.034 |
| $\frac{27}{32}$ | .84375 | 21.431 |
| $\frac{55}{64}$ | .859375 | 21.828 |
| $\frac{7}{8}$ | .8750 | 22.225 |
| $\frac{57}{64}$ | .890625 | 22.622 |
| $\frac{29}{32}$ | .90625 | 23.019 |
| $\frac{59}{64}$ | .921875 | 23.416 |
| $\frac{15}{16}$ | .9375 | 23.813 |
| $\frac{61}{64}$ | .953125 | 24.209 |
| $\frac{31}{32}$ | .96875 | 24.606 |
| $\frac{63}{64}$ | .984375 | 25.003 |
| $\frac{1}{1}$ | 1.000 | 25.400 |

.001" = .0254 mm

| MM | INCHES | MM | INCHES |
|----|--------|-----|--------|
| .1 | .0039 | 46 | 1.8110 |
| .2 | .0079 | 47 | 1.8504 |
| .3 | .0118 | 48 | 1.8898 |
| .4 | .0157 | 49 | 1.9291 |
| .5 | .0197 | 50 | 1.9685 |
| .6 | .0236 | 51 | 2.0079 |
| .7 | .0276 | 52 | 2.0472 |
| .8 | .0315 | 53 | 2.0866 |
| .9 | .0354 | 54 | 2.1260 |
| 1 | .0394 | 55 | 2.1654 |
| 2 | .0787 | 56 | 2.2047 |
| 3 | .1181 | 57 | 2.2441 |
| 4 | .1575 | 58 | 2.2835 |
| 5 | .1969 | 59 | 2.3228 |
| 6 | .2362 | 60 | 2.3622 |
| 7 | .2756 | 61 | 2.4016 |
| 8 | .3150 | 62 | 2.4409 |
| 9 | .3543 | 63 | 2.4803 |
| 10 | .3937 | 64 | 2.5197 |
| 11 | .4331 | 65 | 2.5591 |
| 12 | .4724 | 66 | 2.5984 |
| 13 | .5118 | 67 | 2.6378 |
| 14 | .5512 | 68 | 2.6772 |
| 15 | .5906 | 69 | 2.7165 |
| 16 | .6299 | 70 | 2.7559 |
| 17 | .6693 | 71 | 2.7953 |
| 18 | .7087 | 72 | 2.8346 |
| 19 | .7480 | 73 | 2.8740 |
| 20 | .7874 | 74 | 2.9134 |
| 21 | .8268 | 75 | 2.9528 |
| 22 | .8661 | 76 | 2.9921 |
| 23 | .9055 | 77 | 3.0315 |
| 24 | .9449 | 78 | 3.0709 |
| 25 | .9843 | 79 | 3.1102 |
| 26 | 1.0236 | 80 | 3.1496 |
| 27 | 1.0630 | 81 | 3.1890 |
| 28 | 1.1024 | 82 | 3.2283 |
| 29 | 1.1417 | 83 | 3.2677 |
| 30 | 1.1811 | 84 | 3.3071 |
| 31 | 1.2205 | 85 | 3.3465 |
| 32 | 1.2598 | 86 | 3.3858 |
| 33 | 1.2992 | 87 | 3.4252 |
| 34 | 1.3386 | 88 | 3.4646 |
| 35 | 1.3780 | 89 | 3.5039 |
| 36 | 1.4173 | 90 | 3.5433 |
| 37 | 1.4567 | 91 | 3.5827 |
| 38 | 1.4961 | 92 | 3.6220 |
| 39 | 1.5354 | 93 | 3.6614 |
| 40 | 1.5748 | 94 | 3.7008 |
| 41 | 1.6142 | 95 | 3.7402 |
| 42 | 1.6535 | 96 | 3.7795 |
| 43 | 1.6929 | 97 | 3.8189 |
| 44 | 1.7323 | 98 | 3.8583 |
| 45 | 1.7717 | 99 | 3.8976 |
| | | 100 | 3.9370 |

COMPOUNDS AND CHEMICALS



COMPOUNDS AND CHEMICALS



DUFF POWER!

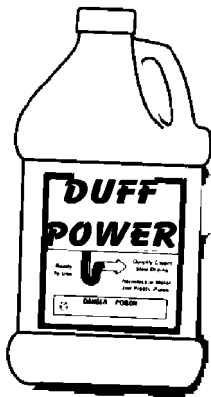

DUFF POWER - Opens clogged drains, dissolves organic matter and melts heavy grease deposits. Contains special corrosion inhibitors and won't harm piping systems, septic tanks or cesspools. FOR PROFESSIONAL USE - SEE SPECIAL NOTICE INSIDE EACH CARTON. Quart Size.

| FIG. NO. | PRICE |
|----------|-------|
| 16071 | |

DUFF CONDITIONER - A non-acid liquid drain cleaner for cleaning of hair, grease, paper, lint and organic matter. Ecologically safe - contains no solvents. 1 Quart.



| FIG. NO. | PRICE |
|----------|-------|
| 44345 | |

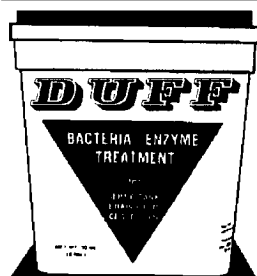

SEPTIC TANK ACTIVATOR - Reactivates septic tanks and drainfield systems. Accelerates natural decay of organic wastes. Use every 6 months to reduce maintenance costs. 32 Oz.

| FIG. NO. | PRICE |
|----------|-------|
| 12623 | |

ROOT DESTROYER - Cleans roots from sewer lines and retards new growth. Use regularly to maintain. 6 LB.



| FIG. NO. | PRICE |
|----------|-------|
| 12632 | |



MURIATIC ACID 20% - 1 Gal. Industrial strength cleaner for tiles, brick, porcelain, masonry, toilet bowls and removes scale from metal surfaces. Made only from pure ingredients.

| FIG. NO. | PRICE |
|----------|-------|
| 16104 | |

CLOROBEN - PT - Dissolves grease, soap, fat and detergent. Eliminates regular grease-trap cleaning. Stops frequent septic tank and cesspool pumping. Restores soil absorption to drainfields. Opens sluggish drains and lines. Kills odors. Non-acid. Non-caustic. Harmless to digestive bacteria.

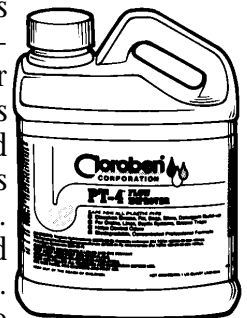

| SIZE | FIG. NO. | PRICE |
|-----------|----------|-------|
| QUART | 16067 | |
| GALLON | 16073 | |
| 15 GALLON | 16076 | |



LIQUID ICE MACHINE CLEANER - Removes scale from ice machines and coffee urns. A food grade phosphoric acid.

| FIG. NO. | PRICE |
|----------|-------|
| 16122 | |



LIME SOLVENT - For professional and Industrial use. Removes lime, scale, urinary salts, plaster, rust and other mineral deposits from hot water coils, boilers, gas water heaters, cooling towers, condensers and heat exchangers. Safe for use on steel, copper, iron, bronze and lead piping. 1 Quart.

| | FIG. NO. | PRICE |
|--------|----------|-------|
| QUART | 12685 | |
| GALLON | 25455 | |

PERMA-CEMENT



Concrete patching cement. Rapid setting, just add water and mix. For sidewalks, steps, driveways, etc.

| | FIG. NO. | PRICE |
|-------|----------|-------|
| 3 LB | 16085 | |
| 10 LB | 16086 | |
| 50 LB | 16087 | |

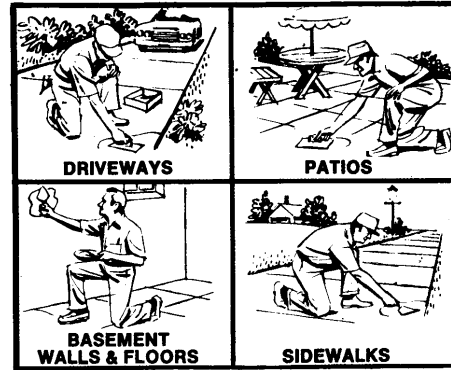

WET PLUG - Hydraulic Cement. Stops water leaks instantly. For exterior or interior use.

| | FIG. NO. | PRICE |
|-------|----------|-------|
| 3 LB | 38032 | |
| 10 LB | 38033 | |
| 50 LB | 38034 | |

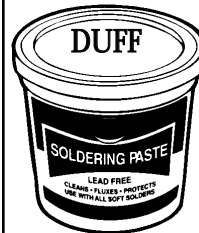

SOLDERING PASTE - Self cleaning, lead free flux specially formulated for seat fitting work. Removes oxidation and prepares copper, brass, tin, stainless steel, cast and wrought iron for the proper bonding of solder to metal assuring leak-tight joints. It makes the solder flow freely and tin perfectly. It's recommended for all soft solder work, including 95/5. Meets federal specification O-F-506.

| | FIG. NO. | PRICE |
|------|----------|-------|
| 2 Oz | 12649 | |
| 4 Oz | 12650 | |
| 1 LB | 12651 | |

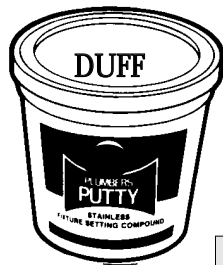

PLUMBER'S PUTTY - A non-bleeding, plastic and elastic putty made especially for plumbers. It's not sticky and handles like modeling clay. It keeps indefinitely and it won't shrink, crack or crumble.

| | FIG. NO. | PRICE |
|-------|----------|-------|
| 14 Oz | 12654 | |
| 5 Lb | 12656 | |



LACO FLUX - Soldering flux paste.

| | FIG. NO. | PRICE |
|-------|----------|-------|
| 2 Oz. | 18997 | |
| 4 Oz. | 18998 | |
| 1 Lb. | 18999 | |



NOKORODE SOLDER PASTE

| | FIG. NO. | PRICE |
|------|----------|-------|
| 2 Oz | 16022 | |
| 1 Lb | 16024 | |



STA-CLEAN - Stay clean soldering flux for virtually all metal other than aluminum, magnesium or titanium. Use with Stay-Brite solders, or practically any other solder with a liquids below 700oF. Not recommended for electrical or electronic applications.

| | FIG. NO. | PRICE |
|-------|----------|-------|
| 16 Oz | 18066 | |
| 4 Oz | 18065 | |

STAINLESS STEEL FLUX

LIQUID - Will not cause progressive corrosion on stainless steel. Also may be used on copper, galvanized, iron, chrome, steel, lead, and brass.

| | FIG. NO. | PRICE |
|-------|----------|-------|
| 4 Oz. | 23833 | |





FORM-A-GASKET NO.1 - Fast drying, improves gasket sealing power, adds reliability to rigid or permanent assemblies. Eliminates delays. Seals and repairs a wide range of gaskets. Fills in uneven flanges, surfaces. Seals pipe fittings, air ducts, boilers, plumbing connections and threaded assemblies. Dries fast, sets hard for sealing permanent or rigid assemblies. Easy to apply. UL Listed. Approved by Bureau of Standards and appeals of NYC. Conforms to MIL-S-45190C (ORD) Type I.

| | FIG. NO. | PRICE |
|-------------|----------|-------|
| 3 Oz. Tube | 32834 | |
| 11 Oz. Tube | 16028 | |



FORM-A-GASKET NO. 3 - Improves reliability of seal on close fitting parts. Easy to use. Seals all types of solid gaskets. Dries slowly, sets to a pliable film for sealing close fitting parts, machined surfaces, and threaded connections in industrial, aircraft and marine engines. Applies easily with brush or roller. UL Listed. Approved by Bureau of Standards and Appeals of NYC. Conforms to MIL-S-45180C (ORD) Type III. 4 FL Oz.

| FIG. NO. | PRICE |
|----------|-------|
| 16032 | |



BLUE SILICONE GASKET - Industrial grade silicone makes gaskets and fills gaps between metal, masonry, plastics, glass, tile, rubber and fabrics. 11 Oz. tube.

| FIG. NO. | PRICE |
|----------|-------|
| 16031 | |



For additional information call: 610-275-4453 or Fax: 610-279-6299
Please call for current prices.



FORM-A-GASKET NO.2 - Increases reliability of gasket seal on flexible assemblies. Saves time, cuts cost. Seals and repairs gaskets on flanges, cover plates, steam lines, hose connections and threaded assemblies. Dries slowly, set to pliable film for sealing semi-permanent or flexible assemblies. Applies easily. Removable. UL Listed. Approved by Bureau of Standards and appeals of NYC. Conforms to MIL-S-45190C (ORD) Type I.

| | FIG. NO. | PRICE |
|------------|----------|-------|
| 3 Oz Tube | 37708 | |
| 11 Oz Tube | 16030 | |

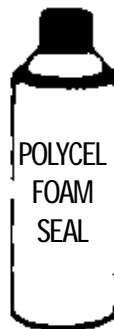

Polycel Foam Seal - Triple expanding insulates and stops drafts. Seals out air and moisture. Non-flammable propellant. Contains HCFC 22/14sb (ODC). Contains fire retardant Class 1 fire rating

| FIG. NO. | PRICE |
|----------|-------|
| 87606 | |

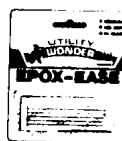

EPOX-EASE Epoxy Putty - This one-part, fast cure epoxy putty has thousands of uses. it can be sanded, painted, filed, sawed, drilled, tapped and it's a metallic gray color. 4 Ounce.

| FIG. NO. | PRICE |
|----------|-------|
| 48953 | |



RED HIGHT TEMP SILICONE GASKET - High temperature silicone makes gaskets that resist 600°F intermittently. Resists aging, weather, and thermal cycling without shrinking, crackling or hardening. 11 Oz. tube.

| FIG. NO. | PRICE |
|----------|-------|
| 55769 | |

Acrylic Latex Caulk - with silicone



| FIG. NO. | PRICE |
|----------|-------|
| CLEAR | 75924 |
| WHITE | 38561 |

Liquid Wrench - Loosens rust and corrosion quickly with teflon.



← 11 Oz. Spray Can

| FIG. NO. | PRICE |
|----------|-------|
| 16036 | |

3 Oz. Squeeze Can →



| FIG. NO. | PRICE |
|----------|-------|
| 20265 | |



Silicone Sealant

3 oz tube

| | FIG. NO. | PRICE |
|-------|----------|-------|
| WHITE | 16026 | |
| CLEAR | 38847 | |

Silicone Rubber Sealant. 10.3 Fluid Ounces for caulk gun. Mold resistant, paintable, permanently flexible.



| OEM # | FIG. NO. | PRICE |
|-------|-------------|-------|
| | WHITE 16025 | |
| | CLEAR 38846 | |

CAULKING GUN - Ratchet type.



| FIG. NO. | PRICE |
|----------|-------|
| 12648 | |



Trace-A-Leak Dye - Tablets and 16 Oz liquid.

Designed for use in:

- *Tracing water leaks
- *Following water lines
- *Examining water currents

Colors Available:

- *Fluorescent Green & Red
- *Non-Flourescent Blue

| | FIG. NO. | PRICE |
|---------|----------|-------|
| Tablets | 38196 | |
| Liquid | 47658 | |

Markal E-Z Break Copper Anti-Seize & Lubricating Compound.

- *Copper Based
- *Resists rust and corrosion.
- *Recommended for coating nuts, bolts, valves, flanges, spines, for easy breakout after years of service.
- *Meets Mil. Spec. Mil-A907E
- *Temperatures to 1800 degrees F.



| FIG. NO. | PRICE |
|----------|-------|
| 16097 | |



PENETRATING OIL - A highly effective penetrant that breaks down rust and corrosion and loosens frozen fittings. It lubricates and protects by inhibiting further corrosion and rust accumulation. 12 oz. aerosol can with spray tube.

| FIG. NO. | PRICE |
|----------|-------|
| 12633 | |

LUBE OIL - A special blend of oils for lubricating, electric motors, pumps and various moving parts. 8 oz.



| FIG. NO. | PRICE |
|----------|-------|
| 38073 | |

RECTORSEAL!



RECTORSEAL 100-W - Virgin, White teflon pipe joint compound specifically formulated for threaded connections where cleanliness, as well as positive sealing is essential. It will not stain hands, soil uniforms or leave a messy appearance. Recommended for threaded connections on lines carrying:

- Acids, LPG, Alkalis, Odorants, Anhydrous Ammonia, Oils, Brine, Petroleum gases, butane, Other Gases (EXCEPT OXYGEN), Caustics, Propane, Corrosives, Solvents, Fuels, Steam

| FIG. NO. | PRICE |
|----------------|-------|
| 1/2 Pint 23974 | |
| 1 Pint 23975 | |

LEAK LOCK

Leak Lock is a soft setting pipe joint compound for threaded joints, flanged joints, gasket surfaces and mating surfaces. It is resin based brushable paste which remains permanently flexible, adheres to internal surfaces and fills voids. Excellent for use on metal and plastic materials subject to extreme vibrations, temperatures from -100F to 400F full vacuum pressures to 10000 PSI. Leak Lock seals most chemicals including all refrigerants, petroleum products, natural and manufactured gases, steam, water, air, etc. Alcohol is the solvent.



RECTORSEAL No. 5 - Yellow Pipe Joint Compound - Meets requirements of American Gas Assoc. for LP-Gas work and National Board of Fire Underwriters Pamphlet #58. Recommended for:

- Acids, Diluted; Air, Compressed Gaseous; Ammonia, Brine; Carbon Dioxide; Caustic Alkalis, Diluted; Cutting oils; Diesel Fuel Oil; Fatty Acids (Liquid); Freons (All); Gasoline; Heating Oils; Hydraulic Oils; Kerosene; Liquefied Petroleum Gases; Manufactured Gases; Nitrogen, Gaseous; Petroleum Solvents; Steamlines; Vegetable Oils; Water Gas

| FIG. NO. | PRICE |
|----------------|-------|
| 1/4 Pint 16041 | |
| 1/2 Pint 16042 | |
| Pint 16043 | |
| Quart 16044 | |



| FIG. NO. | PRICE |
|--------------|-------|
| 1.3 Oz 35807 | |
| 4 Oz 35808 | |
| 1 Pint 35809 | |

For additional information call: 610-275-4453 or Fax: 610-279-6299
Prices are a guide only. Please call for current prices.

GASOILA®



THREAD SEALANT

Smooth non-hardening compound. Outstanding for pipe threads that may require disassembly. Insoluble in gasoline, oils, kerosene, diesel fuels, steam, water and refrigerants as well as may other acids, solvents, gases and chemicals - but not OXYGEN. AGA approved. Use on aluminum, brass, copper, iron, plastic, stainless and steel. 1 pint.

| FIG. NO. | PRICE |
|----------|-------|
| 51608 | |

XPANDO



Withstands deflection, high temperature, vibration. Expands and contracts with pipe movement. Will withstand all pipe pressure. Can be used in below freezing temperatures. Non-toxic. 1 Pint.

| FIG. NO. | PRICE |
|----------|-------|
| 16107 | |

Duff Pipe Thread Compound



| FIG. NO. | PRICE |
|----------------|-------|
| 1/2 Pint 12625 | |
| 1 Pint 12626 | |

LA-CO Sic-Tite Paste with Teflon.

- * Heavy Duty
- * Non-Toxic, non-drying, anti-seize.
- * Certified by AGA and NSF
- * Use on metal and PVC, ABC and CPVC pipe thread connections.
- * Contains more teflon for greater sealing power.
- * Classified by UL in USA and Canada.
- * For use with water, air, natural gas, LP gas, steam, gasoline, oil and refrigerants.
- * Washes off hand and clothing easily.
- * Pressures to 10,000 PSI-liquid; to 3,000 PSI-gas.
- * Temperature range: -50 Deg. F. to +500 Deg. F.



| SIZE | FIG. NO. | PRICE |
|----------|----------|-------|
| 1/2 Pint | 16056 | |
| 1 Pint | 16057 | |

PREMIUM TEFLON TAPES

YELLOW

GREEN

GRAY

**INDUSTRIAL
WHITE**



GAS



OXYGEN



STAINLESS



INDUSTRIAL

Thicker with more teflon density than regular teflon tapes
 Color coded for specific applications Meets or exceeds MIL SPEC T-27730A
 Can withstand temperatures of -450°F and +550°F

| | |
|---|--|
| YELLOW GAS LINE TEFLON THREAD SEAL TAPE | Designed for gas lines of all types...natural gas, propane and butane lines. Meets gas company standards world wide. Full density (1.6) and also 4 mils thick, makes this the heaviest tape available. Seals threads easily and quickly with confidence. Has a temperature range of -450F to +550F. Exceeds Mil Spec, T-27730A. UL listed. |
| GREEN OXYGEN TEFLON THREAD SEAL TAPE | Color coded green for oxygen applications. Grease free, density of 1.2 and 4 mils thick. This is the tape for all your oxygen lines. Will not support combustion. Temperature range of 450F to +550 F. Exceeds Mil Spec. T-27730A. UL listed. |
| GRAY STAINLESS STEEL TEFLON THREAD SEAL TAPE | This tape has nickel pigment color added for use on all stainless steel fittings. Prevents galling, seizing or corrosion. At 4 mils thick and a high density rates, this is the tape for coarse stainless steel threads. Also carries a temperature range of -450F to +550F. Exceeds Mil. Spec. T-27730A. UL Listed. |
| WHITE PREMIUM HIGH DENSITY THREAD SEAL TAPE | For all industrial applications. Made from 100% Virgin Teflon PTFE. No pigments, no additives. May be used on all applications including water, oil, chemical, medical and food processing where non-contamination standards are high. exceeds Mil. spec T-27730a. Temperature range of -450F to +550F. You will feel the difference from all other regular thread seal tapes. |

| YELLOW | | | |
|----------|------|--------|-------|
| FIG. NO. | SIZE | LENGTH | PRICE |
| 61358 | 1/2" | 260 | |

| GREEN | | | |
|----------|------|--------|-------|
| FIG. NO. | SIZE | LENGTH | PRICE |
| 61359 | 1/2" | 260 | |

| GRAY | | | |
|----------|------|--------|-------|
| FIG. NO. | SIZE | LENGTH | PRICE |
| 61360 | 1/2" | 260 | |

| INDUSTRIAL WHITE | | | |
|------------------|------|--------|-------|
| FIG. NO. | SIZE | LENGTH | PRICE |
| 61362 | 1/2" | 260 | |

PLUMBER'S PASTE - Ideal for repairing hairline cracks and leaks and resetting tiles, fixtures and porcelain chips. Easy 1-to-1 mix spreads easily in thin film, achieving an outstanding sealing effect. Bonds, seals, fills. Adheres to basically the same materials as Plumber Seal.

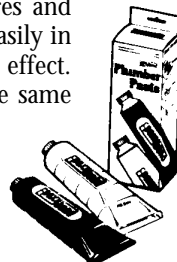

| | FIG. NO. | PRICE |
|-------|----------|-------|
| SMALL | 16094 | |
| 1 LB | 16090 | |



PLUMBER SEAL - Stops most leaks without draining. Packaged in convenient economy cartridges, Plumber Seal mixes like putty, hardens like steel, with easy 1-to-1 mix. Repairs pipes, tubs, tanks, fittings and fixtures. Bonds to steel, aluminum, copper, brass, plaster, brick, concrete, wood and ceramics. Cures under water.

| | FIG. NO. | PRICE |
|-------|----------|-------|
| SMALL | 16092 | |
| 1 LB | 16089 | |

SCRUBS Hand Cleaner Towels



SCRUBS hand cleaner towels - Heavy duty hand cleaning, anywhere, anyplace, anytime! SCRUBS in a bucket provide pleasant smelling removal of heavy grease, lubricants, adhesives, oils, tar, asphalt, inks, wax and many other difficult to remove soils such as coal dust, graphite and grass stains. And, where these soils are absorbed into the patented SCRUBS towels, they DO NOT re-transfer back onto the skin!

| FIG. NO. | PRICE |
|----------|-------|
| 50952 | |

COPPER BRITE - Instant cleaner, eliminates cleaning of copper



| FIG. NO. | PRICE |
|----------|-------|
| 38945 | |

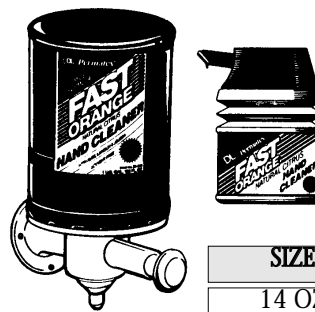

Fast Orange Hand Cleaner - Original formula. Quickly removes deeply embedded grease, oil, dirt and most stubborn soil. Contains lanolin and other soothing emollients to help condition hands against drying, cracking and chapping.

| SIZE | FIG. NO. | PRICE |
|----------|----------|-------|
| 14 OZ | 43715 | |
| 1 GALLON | 58087 | |

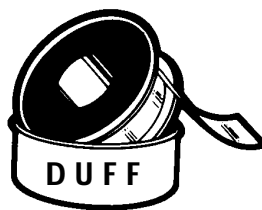

Teflon Tape - Inert, non-toxic, easy to use tape for use on all threaded connections as a pipe dope. It withstands pressures to 10,000 PSI and conforms to MIL-T-27730A. Made of DuPont Teflon.

| | FIG. NO. | PRICE |
|------------|----------|-------|
| 1/2 X 520" | 13201 | |
| 3/4 x 520" | 13217 | |
| 1 X 520" | 13226 | |

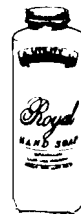

ROYAL POWDERED HAND SOAP
Industrial strength abrasive powder to remove all types of soil. 1 Lb.

| FIG. NO. | PRICE |
|----------|-------|
| 38663 | |

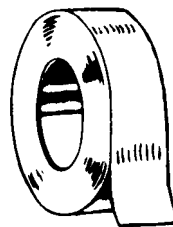

PERMACEL TAPE

For use on threaded joints of metal pipe (not exceeding 1 1/2" pipe size) in assemblies handling gasoline and petroleum oils.

| SIZE | FIG. NO. | PRICE |
|---------|----------|-------|
| 1/2X520 | 18486 | |
| 3/4X520 | 40017 | |

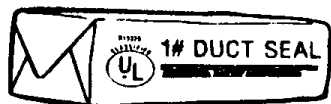

DUCT SEAL COMPOUND

Seals around J-boxes, flashings, service entries and more
 Easy to use, forms around irregular surfaces and configurations
 Resists cracking, drying, shrinking
 Cuts and trims easily and can be painted immediately after application
 20; F working temp: -40°F to 250°F service temp.

| FIG. NO. | PRICE |
|----------|-------|
| 1 lb | 52596 |
| 5 lb | 49003 |



ROOF FLASHING CEMENT

An elastic, black fibre cement for repairing around vent pipes, chimney, etc. Provides weather-proofing around new or old flashings. 1 Gallon

| FIG. NO. | PRICE |
|----------|-------|
| 12658 | |



LEAK DETECTOR

Use to detect leaks in joints on any kind of gas pipeline, especially refrigerants. An extremely active foaming agent. 1/4 pint.

| FIG. NO. | PRICE |
|----------|-------|
| 12642 | |



HEATPROOF GREASE

For stems, valves, etc.

WILL NOT MELT.
2.5 Ounce

| FIG. NO. | PRICE |
|----------|-------|
| 51486 | |

NU-CLEAR THREAD CUTTING OIL

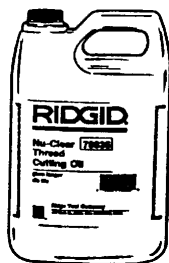

| FIG. NO. | PRICE |
|----------|-------|
| QT | 34615 |
| GAL | 30336 |
| 5 GAL | 30460 |
| 55 GAL | 34617 |

DARK THREAD OIL

| FIG. NO. | PRICE |
|----------|-------|
| QT | 34615 |
| GAL | 30336 |
| 5 GAL | 30460 |
| 55 GAL | 34617 |



CONTACT BURNISHER COMPOUND

Cleans contacts on controls and removes grease and oxide films from all metals. It's perfect for use on oil burners, gas, air-conditioning, switches and electronic controls. Includes spray tube. 1 quart.

| FIG. NO. | PRICE |
|----------|-------|
| 50861 | |



CIRCULATOR OIL

Hydronic circulator oil-1 gallon pump.

| FIG. NO. | PRICE |
|----------|-------|
| 45273 | |



DARK THREAD CUTTING OIL

Sulphur base
 May be used on iron, steel, stainless steel and other metal material
 350°F flash point

| FIG. NO. | PRICE |
|----------|-------|
| 1 QT | 12681 |
| 1 GAL | 12682 |

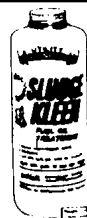

SLUDGE KLEEN

Sludge solvent and fuel oil conditioner. For all grades of fuel oil to reduce soot formation. Keeps nozzles from clogging and disperses sludge and moisture. Increase fuel oil combustion efficiency! 1 Quart.

| FIG. NO. | PRICE |
|----------|-------|
| 48417 | |

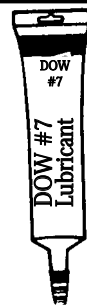

DOW #7 LUBRICANT

5.3 Oz. tube.
 Non-Hardening
 -40°F to 400°F. Contains Silicone. Environmentally Safe!

| FIG. NO. | PRICE |
|----------|-------|
| 23542 | |



DOW #111 HEAVY LUBRICANT

HEAVY DUTY 5.3 Oz. tube. Non-Hardening
 -40°F to 400°F
 Contains Silicone. Environmentally Safe!

| FIG. NO. | PRICE |
|----------|-------|
| 52516 | |

PIPE PROTECTION TAPE



All weather pipe protection tape is a tough PVC plastic tape with special high tack adhesives formulated to resist corrosion. Provides positive protection against abrasion and corrosive action for steel pipe, fittings, electrical conduit systems and gas lines. 100' roll.

| FIG. NO. | WIDTH | THICK | PRICE |
|----------|-------|--------|-------|
| 82344 | 2" | 10 mil | |
| 74557 | 2" | 20 mil | |

PIPE WRAP PRIMER



Quick drying rubber base primer that permeates pits and irregularities on the pipe surface and prepares the metal for tape application. Quart Size.

| FIG. NO. | PRICE |
|----------|-------|
| 45481 | |

WD-40



Penetrates deep to free up frozen or rusted metal parts and fasteners
 Displaces moisture: use it to dry out electrical and electronic equipment
 Stops squeaks
 Cleans: removes grease and road tar
 Will not harm paint, plastics, rubber or fabrics Does not contain silicones
 9 oz.

THE ORIGINAL TROUBLESHOOTER!

| FIG. NO. | PRICE |
|----------|-------|
| 30018 | |

SNOOP

Liquid leak detector



SNOOP liquid leak detector with the "snooper" tube to detect any type gas leak even in hard to reach areas in industrial and residential applications - air, natural gas, propane, helium, acetylene, nitrogen, oxygen.

FEATURES

Non-toxic-pure, Non-flammable, No residue-dries clean, will not collect dust, no chlorine or halogen additives, bubbles indicate size of leak, detect leaks on vertical surfaces, virtually odorless, extendible SNOOPER tube for use in hard to reach areas, safe, positive leak detection.

| SIZE | FIG. NO. | PRICE |
|-------|----------|-------|
| 8 OZ. | 16062 | |

CALGON THERMO-TRAP HEAT ABSORBING PASTE



Thermo-Trap is a heat absorbing paste to protect valves or controls from damage by heat when doing soldering, or welding or brazing near these heat sensitive parts.

| FIG. NO. | PRICE |
|----------|-------|
| 16144 | |

PIPE GASKET LUBE

For soil pipe gaskets, and all gasketed pipe. 1 Quart.



| FIG. NO. | PRICE |
|----------|-------|
| 7496 | |

ENFORCER WASP & HORNET KILLER



Shoots a 20 ft. blast
 Instant knockdown
 Quick kill
 Non-conductive to 37,000 volts
 16 Oz. spray can

| FIG. NO. | PRICE |
|----------|-------|
| 50869 | |



MICROMET

A slowly soluble food-grade hexametaphosphate product that is safe for use in drinking water supplies. For preventing red iron water problems, lime scale and controlling corrosion (rust). 5 lb.

| FIG. NO. | PRICE |
|----------|-------|
| 16126 | |



IRON OUT

Chemically changes iron oxide (rust) into a clear, soluble state that will easily flush away.

Removes rust and stains from water softeners, toilets, sinks/tubs, white clothes and dishwashers.



| SIZE | FIG. NO. | PRICE |
|--------|----------|-------|
| 18 Oz. | 9302 | |
| 5 Lb. | 9303 | |

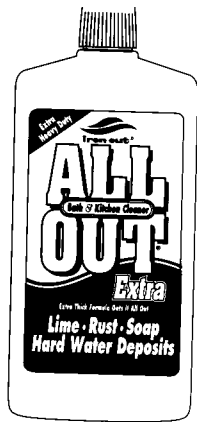

ALL OUT

Extra heavy duty - safely cleans lime, rust, soap and hard water deposits! 1 1/2 Pint.

| FIG. NO. | PRICE |
|----------|-------|
| 47832 | |

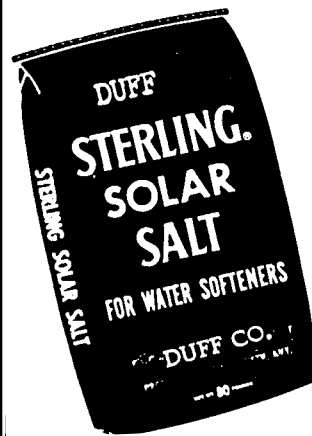

SOLAR SALT

| DESCR. | FIG. NO. | PRICE |
|---------------------|----------|-------|
| Solar Salt 50 Lb. | 9304 | |
| Solar Salt 80 Lb. | 9301 | |
| Pellet Salt 50 Lb. | 46832 | |
| Red Out Salt 40 Lb. | 47517 | |
| Rock Salt 80 Lb. | 50865 | |
| Rock Salt 50 Lb. | 50864 | |



FURNACE CEMENT - For temperatures up to 1800 Degrees F. For sealing and patching hot surfaces.

| | FIG. NO. | PRICE |
|---------|----------|-------|
| 1 LB | 24842 | |
| 1/2 GAL | 12674 | |
| 1 GAL | 12675 | |



FOOD GRADE SILICONE - A multi-purpose product that lubricates water-proofs and protects surfaces while being odorless, colorless and tasteless. USDA NO. H-1

| FIG. NO. | PRICE |
|----------|-------|
| 63804 | |

SOIL SEAL - Pre-mixed perfect seal for soil pipe joints. Hardens quickly. Can be used as a cold solder on waste lines carrying low pressure water, steam, gas and oil.



| SIZE | FIG. NO. | PRICE |
|-------|----------|-------|
| 22 OZ | 12662 | |
| 10 OZ | 12660 | |



INSULSAFE NON-ASBESTOS INSULATING CEMENT

| SIZE | FIG. NO. | PRICE |
|-------|----------|-------|
| 50 LB | 14141 | |
| 5 LB | 14140 | |

SILVERKING



"Hydronic" Formula No. 5 - with silicone sk-471. Will reduce fuel consumption in Hot Water Systems up to 20% by more efficient boiler operation. Waste of energy and pollution are greatly reduced. Lubricates metal plastic and rubber parts and protects entire internal system against fouling - contains no petroleum.

GUARANTEE

- * Removes sludge - frees and lubricates zone valves.
- * Protects the pump by lubricating the seal.
- * Removes insulating sludge on submerged coils.
- * Prevents clogging of automatic (hot water) Valves.
- * Frees and lubricates stuck flow valves.

| FIG. NO. | PRICE |
|----------|-------|
| 16047 | |

ALL BRASS FORCE & SUCTION PUMP

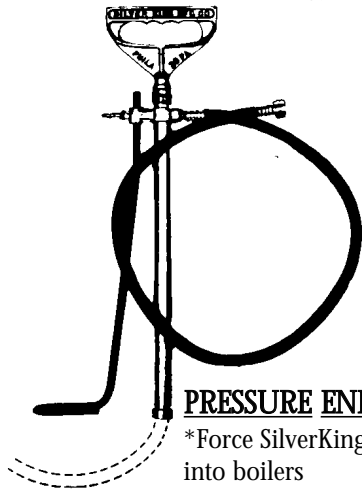

PRESSURE END

- * Force SilverKing into boilers through draw off
- * Open clogged drains
- * Test radiant heat
- * Open clogged fuel lines
- * Sprays insecticides
- * Test soil pipe

SUCTION END

- * Draw sludge or water from fuel oil tanks
- * Empties toilets and traps
- * Drains plumbing fixtures
- * Use it as a Bilge pump

| | FIG. NO. | PRICE |
|-----------|----------|-------|
| Pump | 16051 | |
| Hose Only | 16052 | |



QUICK cleaner and inhibitor with anti foam silicone sk-24 guaranteed to stop boiler surge INSTANTLY. For high and low pressure steam boilers. Use 1 can for each 150,000 BUT's of boiler rating. Will reduce fuel consumption in steam heating systems up to 30% by more efficient boiler operation. Waste of energy and pollution are greatly reduced.

| FIG. NO. | PRICE |
|----------|-------|
| 16046 | |

SAFE BOILER STOP LEAK
with Anti Foam Silicone SK-24
SILVER KING SILICONE SK-24 - THE GREATEST IMPROVEMENT EVER DEVELOPED IN STOP LEAK CHEMICALS FOR STEEL AND CAST IRON BOILERS. WILL NOT SURGE - WILL NOT SLUDGE - WILL NOT CLOG.

Silver King stop leak compounds are scientifically formulated to insure a water insoluble seal in steam boilers and throughout entire hot water systems, including leaks in copper lines, radiators, and radiant heat. Also recommended for auto cooling systems.

The Silver King force and suction pump (FIG. NO. 16051) completes the job in minutes.

Guaranteed to stop all leaks in radiant heating systems.

Recommended for both high and low pressure boilers.



powder



liquid

| FIG. NO. | PRICE | FIG. NO. | PRICE |
|----------|-------|----------|-------|
| 16049 | | 16048 | |

SPEEDY INJECTOR GUN

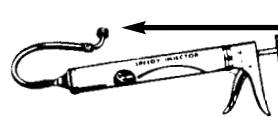

garden hose thread

injects boiler chemicals into boilers without shutting down system.

| FIG. NO. | PRICE |
|----------|-------|
| 61457 | |



Gallon.

NO FREEZE 30 - Low temperature heat transfer to protect hot water heating systems from freeze-ups. Excellent for summer homes, RV's, solar collectors, marinas, etc. Can withstand temperatures of 350 Deg. F. over extended period and normal make-up water. Odorless, safe. One

| FIG. NO. | PRICE |
|----------|-------|
| 12687 | |



VIKING COIL CLEANER - An efficient inhibited acid for removal of scale, lime, rust, calcium, iron, etc. For coils, water heaters, urinals, heating and air conditioning equipment. One Gallon

| FIG. NO. | PRICE |
|----------|-------|
| 16099 | |

SOOT SCOOT - Toss-in duo-pac eliminates soot in combustion chambers for more efficient performance. Easy to use. No mess.

| FIG. NO. | PRICE |
|----------|-------|
| 12667 | |



HYDRO ZORB - Fuel Tank Water Absorber. Clears up problems caused by freezing. Will absorb twice its weight in water. Inhibits corrosion as it breaks down deposits of sludge and gums. Serves as an anti-freeze compound to prevent future freezeups. Quart Size.

| FIG. NO. | PRICE |
|----------|-------|
| 30917 | |

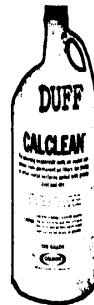

CALCLEAN DETERGENT - Heavy duty liquid cleaner for spray cleaning evaporator coils. Air cooled condenser coils, metal filters, fan blades and other surfaces soiled with greasy dust and dirt. Will not corrode any metal when used as directed. Also cleans pots, pans, floors, woodwork, etc. 4 Liter.

| FIG. NO. | PRICE |
|----------|-------|
| 16167 | |



WATER FINDING PASTE 2.4 Oz. Detects water in oil or gasoline tanks.

| FIG. NO. | PRICE |
|----------|-------|
| 16035 | |

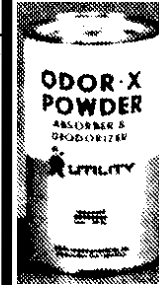

ODOR-X POWDER - An easy to use powder. Just sprinkle on oil spills - removes both the stain and the odor. 1 LB can.

| FIG. NO. | PRICE |
|----------|-------|
| 12670 | |



OIL DRY a pre-treated absorbent eliminates odors as it absorbs oil, grease and liquid spills. It's non-flammable and easy to use. 25 LB. Bag.

| FIG. NO. | PRICE |
|----------|-------|
| 49291 | |



HOT 4 IN 1 HEATING OIL TREATMENT - Concentrate. Totally disperses water Promotes clean flame Controls waxing and gelling Prevents corrosion Cleans pump and filter Reduces smoke Cleans burner tips Eliminates "varnish" Eliminates soot 16 Oz.

| FIG. NO. | PRICE |
|----------|-------|
| 49716 | |



INSTANT GALVANIZE Fuses the zinc component to the base metal. Corrosion will attack only the outer zinc coating leaving the metal protected RUST FREE.

| FIG. NO. | PRICE |
|----------|-------|
| 18255 | |



3-Prong Grappler.....697
 4-in-1 Tool.....678
 6-in-One Screwdriver.....648
 4-Way Sillcock Key.....684

- A -

AAR Fittings.....50-51
 Abrasive Pads.....678
 ABS Pumps.....387
 Access Panel.....210
 Accustat.....296
 Ace Boiler Plugs.....344
 Ace-In-The-Hole.....375
 Acetylene Regulator.....675
 Acetylene Tanks.....675
 Acetylene Kits.....675
 Acid Brush.....678
 Actuators.....40
 Add-A-Shower.....243
 Add-A-Valve.....41
 Adjustable Wrench.....648
 ADS.....459, 599
 Aerator Repair Kits.....263
 Aerators.....258, 468
 Air Acetylene Kits.....675
 Air Chief.....625
 Air Cleaners.....334
 Air Filters.....334
 Air Filters.....623
 Air Float.....425
 Air Gun.....13, 624
 Air Hose.....624
 Air Lubricators.....623
 Air Purger.....304
 Air Regulators.....624
 Air Relief Valves.....624
 Air Separator.....307
 Air Tank Kit.....697
 Air Vent, Steam.....313-315
 Air Vents.....304
 Air Volume Control.....434
 Airraider.....576-577
 Aircocks.....8
 Airtrol Fitting.....305
 All Thread.....131
 All Fuel Chimney.....336
 All Out.....730
 Aluminum Pipe Fittings.....83
 Aluminum Tubing.....122
 American Standard Flush Valve.....227, 231
 American Standard Tank Lever.....229, 231
 American Standard Closet Repair Parts.....227
 American Tube Hangers.....133
 Ametek Bag Filter.....486
 Ametek Cartridge Filters.....472-480
 Ametek Valve Boxes.....599
 Amprobe.....716

Amtrol Hangers.....133
 Amtrol Tanks.....435-436
 Analog Multimeter.....716
 Anchors.....134-135
 Angle.....135
 Angle Iron.....135
 Angle Stop Valves.....3
 Angle Valves.....13
 Anthracite.....503
 Appliance Dolly.....703-704
 Aqua Pure.....489-490
 Aquastat.....292
 Arbor Adapter.....636
 Argo Controls.....291
 Armaflex.....339
 Armstrong Pumps.....387
 Asco Solenoid Valves.....28
 Aurora Pumps.....387
 Autotrol.....495-499, 506, 513-520
 Aviation Snips.....694
 AWWA Valves.....39

- B -

"B" Pressure Regulator.....328
 B Vent.....336
 B Tank.....674
 Babbit Sprocket Rims.....41
 Back Pressure Relief Valve.....327, 429
 Back Supporters.....709
 Back Up Sump Pump.....375
 Backflow Preventers.....356-362
 Backwashing Filters.....497
 Backwater Valve, PVC.....596
 Bag Filters.....463, 485-486
 Bailers.....432, 438
 Balancing Valves.....305
 Ball Check Valve, PVC.....604
 Ball Drip.....147
 Ball Offset.....189

BALL VALVES

Actuated.....17
 Bronze, Industrial.....15
 Bronze, with Waste.....8
 Bronze, with Locking Handle.....16
 Bronze, Compact.....5
 Carbon Steel.....15
 Cast Iron.....16
 Compressed Air.....17
 Flanged.....16
 Gas.....19
 PVC.....604
 Stainless Steel.....15
 Three Way.....17

Ballcock Repair Kit.....263
 Ballcocks.....226-227
 Band Iron.....128

Band Saws.....642-643
 Barbs, Brass.....614
 Barbs, Plastic.....614
 Bar Sink.....216
 Bar Strainers.....205
 Barco Joints.....97
 Barnes & Jones.....332-333
 Barnes Pumps.....387
 Barrel Faucets.....7
 Baseboard.....286
 Basin Cocks.....170, 189
 Basin Fork Wrench.....686
 Basin Nut Wrench.....654, 684
 Basin Wrench, Ridgid.....654
 Basket Strainers, Pipe.....116
 Bath Cocks.....171, 189
 Bath Cock Couplings.....189
 Bath Diverter Repair Kit.....263
 Bath Offset Coupling.....189
 Bathtubs.....220
 Bathroom Accessories.....235-236
 Batteries.....717
 Battery Operated Pumps.....375
 Bayer.....541
 Beam Clamps.....130
 Beam Brackets.....131
 Bell & Gossett Industrial Pumps.....393-394
 Bell & Gossett Pumps.....301-302, 393-394
 Bell & Gossett Pressure Regulators.....306
 Bell Trap, Cast Iron.....107
 Bell Trap, PVC.....596
 Bemis.....222
 Bending Spring.....673
 Bernz-o-Matic.....674
 Bentonite.....438
 Berkley Pumps.....390
 Bibb Reamer.....684
 Bibb Screw Tap.....259
 Bibb Screws.....259, 262
 Bibb Seats.....72, 181, 253-256
 Bibb Seat Tools.....686
 Bibb Seat Gauge.....686
 Bibb Seat Remover.....686
 Bibb Washers.....259
 Big Nipper.....699
 Birm.....502
 Bits.....638, 648-649
 Black Fittings.....50-51
 Black Nipples.....52-55
 Blind Flanges.....59
 Blow-off Valves.....25, 34-35
 Blow Out Gun.....696
 Boilers.....279-283
 Boiler Chemicals.....731-732
 Boiler Drains.....3, 5
 Boiler Feed Controls.....322

| | | | | | |
|-----------------------------------|--------------|---|--------------|---|----------|
| Boiler Plugs..... | 344 | Cash Acme..... | 309 | Chrome Plated Brass Pipe..... | 63 |
| Boiler Solder..... | 731 | Cast Iron Baseboard..... | 286 | Chrome Plated Fittings and Nipples..... | 99, 213 |
| Boiler Valves..... | 25, 34-35 | Cast Iron Flanged Fittings..... | 60 | Circular Saw..... | 643-644 |
| Bolt Cutters..... | 653 | Cast Iron Flanges..... | 59 | Circular Box..... | 599 |
| Bolts and Nuts..... | 59 | Cast Iron Pipe Fittings..... | 57-60 | Circulator Pumps..... | 299-301 |
| Boosterpaq..... | 392 | Cast Iron Specialties..... | 105-109 | Circulator Oil..... | 728 |
| Boosters..... | 276 | Cast Steel Valves..... | 42 | Circulator Couplings..... | 303 |
| Booster Pumps..... | 389, 392 | Catch Basin, PVC..... | 597 | Citric Acid..... | 562 |
| Boot..... | 211 | Catch Basin, Galvanized..... | 107 | Clamps, Stainless Steel..... | 611 |
| Bottle Drain..... | 592 | Caulking Gun..... | 690, 724 | Clay Valves..... | 355 |
| Bottled Coolers..... | 247 | Caulking..... | 690 | Cleaner Inhibitor..... | 731 |
| Bowl Wax..... | 224 | Caulking Lead..... | 213 | Cleanout Plug, Brass..... | 109 |
| Bradley..... | 252 | Caulking Tools..... | 687 | Cleanout..... | 109 |
| Bradtrol..... | 252 | Caustic Soda..... | 562 | Clear PVC Pipe..... | 593 |
| Brady Valves..... | 429 | Caution Tape..... | 691 | Clevis Hangers..... | 129 |
| Brass Companion Flange..... | 70 | Cements, PVC..... | 608 | Cloroben..... | 721 |
| Brass Fittings, 125#..... | 71 | Centaur..... | 502 | Close Coupled Bolts..... | 223 |
| Brass Insert Fittings..... | 433 | Center-O-Punch..... | 681 | Close Coupled Gaskets..... | 228 |
| Brass Nipples..... | 72 | Central Brass..... | 170-173, 201 | Closets..... | 218-220 |
| Brass Pipe..... | 63 | Centrifugal Pumps..... | 388-394 | Closet Augers..... | 706-707 |
| Braukman Filter..... | 488 | Cesspool Plate, Cast Iron..... | 107 | Closet Bends..... | 105 |
| Braukman Pressure Regulator..... | 306 | Chain Saw..... | 644 | Closet Bolt Caps..... | 230 |
| Brine Tanks..... | 527, 528-529 | Chain Hoist..... | 703 | Closet Bolts..... | 223 |
| Bronze/flow..... | 677 | Chair Hanger..... | 221 | Closet Flanges, Cast Iron..... | 105 |
| Brush, Fin and Coil..... | 697 | Channel Lock..... | 693 | Closet Flanges, Copper..... | 97 |
| Brushes..... | 678-680, 697 | Channel..... | 132 | Closet Flanges, No Caulk..... | 105 |
| Bubblers..... | 253 | CHECK VALVES | | Closet Screws..... | 223 |
| Bulbs..... | 717 | Bronze, Industrial..... | 12-14 | Closet Seat Nut Wrench..... | 683 |
| Bulkhead Fittings..... | 104, 592 | Bronze, Compact..... | 5 | Closet Seats..... | 222 |
| Bulldog Pitless Adapter..... | 426 | Durabla..... | 41 | Closet Spuds..... | 228 |
| Bungee Cords..... | 690 | Fire Protection..... | 35 | Closures..... | 69 |
| Butt Fusion Equipment..... | 460 | Flomatic..... | 430-432 | Cloth Inserted Gasket Material..... | 73 |
| Butterfly Valves..... | 26-27, 604 | Iron..... | 24-25 | Coast Ballcock..... | 227 |
| Butterfly Valves, PVC..... | 604 | Pump..... | 429-431 | Cock Hole Covers..... | 205 |
| By-Pass Valves..... | 501 | Sewage Pump..... | 431 | Coconut Shell Carbon..... | 455, 502 |
| | | Silent..... | 25 | Coils..... | 269 |
| | | Spring Loaded..... | 19 | Coil Cleaner..... | 732 |
| | | Stainless Steel..... | 38 | Coil Cleaning Pump..... | 386 |
| | | Sump Pump..... | 374 | Coil Fin Straightener..... | 697 |
| | | Well Pump Checks..... | 429 | Coin Air Vent..... | 313-315 |
| - C - | | Chem-Tech..... | 543-547, 551 | Coldfire..... | 673 |
| C Series Pumps..... | 391 | Chemical Feed Pumps..... | 543-556 | Column Shower..... | 252 |
| C-Clamps..... | 130 | Chemical Contaminant Filtration System..... | 480 | Combination Hose Nipples..... | 618 |
| Cable, Ignition..... | 348 | Chemicals, Boiler..... | 731-732 | Commercial Water Heaters..... | 270-277 |
| Cable, Pump..... | 416-418 | Chemicals, Water Treatment..... | 560-562 | Commercial Disposers..... | 265 |
| Cable, Thermostat..... | 344 | Chemtrol Valves..... | 604 | Companion Flanges..... | 59 |
| Cable Guard..... | 425 | Chemtrol..... | 593 | Companion Flange, Brass..... | 70 |
| Cable Saw..... | 698 | Cherne Test Balls..... | 672 | Compact Kitchen..... | 220 |
| Cable Ties..... | 104 | Chicago Faucet..... | 201, 253 | Compass Saw..... | 698 |
| Cad Cell Flame Detector..... | 293 | Chimney Brushes..... | 680 | COMPRESSION VALVES AND FITTINGS | |
| Cage Units..... | 332-333 | Chimney Liner..... | 336 | Ball Valve..... | 8 |
| Calcite..... | 502 | China..... | 218-220 | Brass..... | 120-122 |
| Caliper..... | 697 | Chisels..... | 669, 687 | Chrome Plated Brass..... | 213 |
| Candle..... | 697 | Chlorinators..... | 557-558 | CPVC Coupling..... | 607 |
| Carbon Filtration Units..... | 454-457 | Chop Saw..... | 644 | Dresser Type..... | 65 |
| Carbon..... | 455, 502 | | | Gas..... | 101 |
| Carbon Steel Flanges..... | 77 | | | | |
| Carrier Nuts..... | 231 | | | | |
| Cartridge Filters..... | 472-480 | | | | |
| Cartridge Filter Accessories..... | 480 | | | | |

John Guest.....572-573
 Normac.....101
 Nylon.....574-575, 615
 PVC Swing Check.....603
 PVC Couplings.....603
 Slip Joint Fittings.....207, 209
 Stop and Waste.....3
 Stop Valve.....8
 Sump Pump Check Valve.....374
 Tubular.....207, 209
 Condensate Pump, Cold Water.....386
 Condensate Pump, Steam/Hot Water.....331
 Condensate Trap, PVC.....583
 Consolidated Relief Valves.....311
 Continuous Waste.....206
 Contractor Hose.....613
 Contractor Pump.....377
 Control Boxes.....424
 Controls, Heating.....289-296
 Convector.....287
 Copper Brite.....727
 Copper Fitting Tools.....678
 Copper Fittings.....86-98
 Copper Shut-Off Tool.....650
 Copper Tubing Cutters.....650, 652-653, 655
 Copper Tubing.....84-85
 Cork Insulation Tape.....342
 Corosex.....502
 Corrugated Pipe.....69, 599
 Corzan Pipe.....591
 Couplings, Circulator.....303
 Covert Pumps.....387
 Coyote.....420
 CPVC Cements.....608
 CPVC Nipples.....590
 CPVC Tubing and Fittings.....607
 CPVC Pipe, Sch 80.....587, 591
 CPVC Fittings, Sch 80.....588-589
 CPVC Valves.....607
 Crane Parts.....256
 Crane Flappers.....225
 Creamery Hose.....613
 Crimpers.....694
 Cryogenic Valves.....42
 Culvert Pipe, Plastic.....599
 Culvert Pipe, Steel.....69
 Cuno Filters.....489-490
 Cup Strainer.....205
 Curb Box Wrench.....689
 Curb Stop.....4
 Cutter Wheels, Pipe.....666
 Cutter Wheels, Tubing.....653
 Cutter Board.....681

-D-

"D" Rod.....243

Danfoss.....297
 Deburring Tool, PVC.....699
 Deep Socket Wrench.....684
 Deionization Cartridges.....479
 Delaney Flush Valves.....202
 Delex.....188
 Delta Faucets and Parts.....185-188
 Delta Faucet Wrench.....684
 Diaphragm Level Control.....374
 Diaphragm Pumps.....387
 Diaphragm Valves.....33
 Die Heads, Ridgid.....656
 Dielectric Fittings.....306
 Dies.....656-657
 Dip Tube.....278
 Dipper Well Faucet.....190
 Discharge Hose.....617
 Dishwasher Connectors.....212
 Dishwasher Disposer Connector.....211
 Disposal Elbows.....265
 Diverter Repair Kit.....263
 Dole Flow Regulators.....364-366
 Dole Air Valves.....313-315
 Dolly (Hand Truck).....704
 Dope Brushes.....679
 Double Containment Piping.....448
 Double Tapped Bushing.....348
 Douglas.....693
 Douglas Flush Valve.....228
 Dow.....541
 Dow Lubricant.....728
 Draft Regulator.....336
 Drain Cleaner, Acid.....721
 Drain Cleaner, Non-Acid.....721
 Drain Cleaners, Ridgid.....712-715
 Drain Cleaners, General Wire.....705-711
 Drain Cock.....8
 Drain King.....672
 Dresser Couplings.....65-66, 603
 Drills.....629-634
 Drill Bits.....638, 648-649
 Drill Chucks, Magnetic.....689
 Drill Pump.....377
 Drill Set.....648
 Drinking Fountains.....248-249
 Drip Pan.....278
 Drive Cap.....429
 Drop Coupling.....426
 Drop Head Threader.....656
 Dryer Vent.....337
 Dual Control.....309
 Duct.....337
 Duct Seal.....337
 Duct Tape.....342
 Duff Drain Cleaner.....721
 Duff Power.....721

Duncan Guide.....223
 Duo Strainer.....204
 Duplex Strainers.....116
 Durabla Check Valves.....41
 Dust Mask.....691
 Dutch Finger.....671
 Dyna-Pak.....452-453

-E-

E-Z Break.....724
 Easy Reach.....703
 Ebco.....250
 Econosoft Softeners.....542
 Effluent Pumps.....382
 Ejector Screen.....420
 Electric Lead Pot.....688
 Electric Soldering Tool.....673
 Electrical Tape.....344, 417, 716
 Electrical Testers and Tools.....716-717
 Electrostatic Air Filters.....334
 Elements.....278
 Element Wrench.....278
 Eljer Touch Flush.....225
 Elkay Drains.....190
 Elkay Parts.....256
 Emergency Equipment.....251
 Emery Cloth.....678
 Enfield.....593
 Engine Drive Pumps.....377
 Enforcer.....729
 Enviro Check Valves.....430, 432
 Environmental Pipe.....432, 438, 450-451
 Epoxy.....723, 726
 Epoxy Coated Retention Tanks.....437

ESCUTCHEONS

Extension Stop.....213
 Sprinkler Head.....149
 Supply Tube.....207
 Tubular Brass.....207
 Everlasting Valves.....34
 Evertite Fittings.....619
 Everpure.....476
 Excellon Pipe.....593
 Expando.....725
 Expansion Couplers.....123, 305
 Expansion Joints, Fernco.....103
 Expansion Joints.....103, 124
 Expansion Shields.....134-135
 Expansion Tank Drain.....305
 Expansion Tanks.....304, 305
 Extension Cords.....717
 Extension Ladders.....702
 Extra Heavy Pipe Fittings.....50-51
 Eyewash.....251

-F-

Fabrication, PVC.....139

Fans, Non Corrosive.....626
 Fast Orange.....727

FAUCETS

Barrel.....7
 Central Brass.....170-173, 201
 Chicago.....201
 Delta.....185-188
 Economy.....189
 Laundry Tray.....217
 Moen.....182-184
 Optima.....201
 Powers.....174-180
 Powers.....201
 Sloan.....201
 Speakman.....253
 Symmons.....181
 T&S Brass.....157-170, 201
 Zurn.....201

FAUCET PARTS

American Standard.....254, 261
 Bradley.....252
 Central Brass.....172-173, 261
 Chicago.....253, 261
 Crane.....256, 261
 Delta.....187-188, 261
 Elkay.....256
 Gerber.....256, 261
 Handles.....257
 Kohler.....254, 261
 Moen.....182, 184, 261
 Powers.....176-180
 Sayco.....261
 Speakman.....253
 Sterling.....255, 261
 Symmons.....181
 T&S.....164-169, 261
 Faucet Repair Kits.....261
 Faucet Seat Gauge.....686
 Feed Water Regulators.....309
 Fernco Fittings.....103-104
 Fiberglass Filtration Tanks.....456
 Fiberglass Grating.....613
 Fiberglass Insulation.....340
 Field Controls.....336
 Fill Box Key.....661
 Fill Box.....348
 Fill Cap.....348
 Fill Valves.....20-22
 Fillmaster.....226
 Filltrol.....304
 Filter Ag.....503
 Filters, Air.....623
 Filters, Water.....497-503
 Filter Housings.....472-474, 481-485
 Filter Wrenches.....480

Filtration Media.....502-503
 Fin and Coil Brush.....697
 Fin Tube.....287
 Fire Hose.....154
 Fire Hydrant Wrench.....154
 Fire Hydrant.....154
 Fire Protection Valves.....35, 144-148
 Fire Stops.....150-151
 Fisher Drains.....190
 Fit All Plug.....108, 213
 Fit All Tank.....230
 Fitting Brush.....678

FITTINGS

Air Hose.....619
 Aluminum.....83
 Brass.....71
 Bulkhead.....592
 Cast Iron.....57-60
 Chrome Plated.....99
 Compression, Brass.....120-122
 Compression, Chrome Plated.....213
 Copper.....86-98
 Corrugated Plastic.....599
 CPVC Tube.....607
 CPVC, Sch 80.....588-589
 Dresser.....65-66, 603
 Extra Heavy.....50-51
 Fernco.....103-104
 Flanged.....60
 Flare.....117-119
 Forged Steel.....74-75
 Gas.....101-102
 Gasketed.....598
 Gastite.....102
 Insulation.....338
 Insert.....433, 610-611
 Jaco.....574-575
 John Guest.....572-573
 Malleable, Black and Galvanized.....45-56
 Monoflo.....348
 Normac.....101
 Nylon.....574-575
 Polypropylene.....593
 PVC, DWV.....596
 PVC, Sch 40.....581-583
 PVC, Sch 80.....584-587
 Qest.....571
 Radiator.....348
 Railing.....80
 SDR 35.....598
 Sewer and Drain.....597
 Slip Joint.....207, 209
 Socket Weld.....75
 Smoke Pipe.....335
 Soil Pipe.....110-113

Stainless Steel.....81-83
 Strut.....132
 Tank.....592
 Victaulic.....81
 Weld.....77
 Zeston.....338

Fixtures.....218-220
 Flameshield.....673
 Flange Gaskets.....60
 Flange and Bolting Dimensions.....61
 Flange Bolts and Nuts.....59
 Flange Spreader.....682
 Flange Tool.....696
 Flanged Fittings.....60

FLANGED VALVES

Ball Valve, Cast Iron.....16
 Bronze.....17
 Carbon Steel.....17
 Flexible Connectors.....124
 Stainless Steel.....17
 Strainers.....115
 Flanges, Selection.....76

FLANGES

Bronze.....70
 Carbon Steel.....77
 Cast Iron.....59
 Closet, Copper.....97
 Closet, Cast Iron.....105
 Copper.....98
 CPVC.....589
 PVC.....585-586
 Selection, Forged Steel.....76
 Welding, Steel.....77

Flappers.....225
 Flare Fittings, Brass.....117-119
 Flare Valves.....8
 Flaring Tool.....673
 Flaring Tool, Ridgid.....655
 Flashing.....211
 Flashing Cement.....728
 Flashlights.....717
 Float and Thermostatic Traps.....326
 Fleck.....495-499, 507-512, 521-526
 Flexduct.....337
 Flexible Connectors.....123, 305
 Flexitallic Gaskets.....61
 Flints.....674
 Flip-It Tub Stopper.....201
 Flo Valves.....306
 Flo-Meters.....368-369, 551
 Floats.....20-22, 226
 Float Rod.....226
 Float Switches.....396, 398
 Flue Brushes.....678-680
 Float Valve, Plastic.....604
 Float Valves.....20-22, 226

| | | | | | |
|---|-----------------------|----------------------------------|----------|-----------------------------------|----------|
| Flomatic Check Valves..... | 430-431 | Gas Range Connect..... | 343 | Stop and Check..... | 24 |
| Flood Guard..... | 670 | Gas Regulators..... | 343 | Gloves..... | 691 |
| Floor Drain, PVC..... | 596 | Gas Service Tool..... | 695-696 | Goggles..... | 691 |
| Floor and Ceiling Plates..... | 344 | Gas Tanks..... | 674 | Golden Gallon Gauges..... | 346 |
| Flow Regulators..... | 364-366 | Gas Tap..... | 695 | Goldline..... | 294 |
| Flow Switches..... | 322 | Gas Teflon Tape..... | 343 | Goulds Pumps..... | 387 |
| Flue Brushes..... | 678-680 | Gas Test Gauge..... | 696 | Grab Bars..... | 237 |
| Fluidmaster..... | 225-226 | Gas Valves..... | 101 | Granular Acid..... | 562 |
| Flush Valve Reseater Tool..... | 683 | Gas Valves..... | 295 | Granular Carbon..... | 455, 502 |
| Flush Joint Pipe and Fittings..... | 438, 450-451 | GASKETS | | Grappler..... | 697 |
| Flush Valves..... | 191-200, 202 | Flange..... | 60 | Grates, Cast Iron..... | 108 |
| Flusher Fixer Kit..... | 225 | Flexitaullic..... | 61 | Grating, Fiberglass..... | 613 |
| Flushmate..... | 231 | Handhole..... | 283 | Gravel..... | 503 |
| Flux..... | 722 | Manhole..... | 283 | Grease Trap..... | 221 |
| Foil Tape..... | 342 | Material..... | 73 | Greensand..... | 502 |
| Food Grade Silicone..... | 730 | Tank to Bowl..... | 228 | Grid Drain..... | 205 |
| Foot Valves..... | 25, 429-430, 432, 618 | Gasket Cutter..... | 681 | Grinder Pumps..... | 381 |
| Force Cups..... | 690 | Gasket Cutter Board..... | 681 | Grinders..... | 645-646 |
| Force Pump..... | 731 | Gasket Lube..... | 729 | Gripzit..... | 696 |
| Forged Steel Fittings..... | 74-75 | Gasketed PVC Fittings..... | 598 | Grizzly..... | 410-411 |
| Forged Steel Valves..... | 36-37 | Gasola..... | 725 | Grooved Fittings..... | 81, 152 |
| Form-A-Gasket..... | 723 | Gastite..... | 102 | Ground Key Stop and Waste..... | 4 |
| Fountains..... | 248-249 | GATE VALVES | | Grundfos Circulators..... | 301 |
| Franklin Motor Controls..... | 421 | Bronze, Industrial..... | 12-14 | Grundfos Environmental Pumps..... | 441-448 |
| Franklin Motors..... | 422-423 | Bronze, Compact..... | 5 | Grundfos Industrial Pumps..... | 391 |
| Franklin Drains..... | 190 | Forged Steel..... | 37 | Grundfos Jet Pumps..... | 413 |
| Freeze Kits..... | 670 | Iron..... | 24 | Grundfos Redi-Flo Pumps..... | 441-448 |
| Friction Ring..... | 228 | Knife..... | 33 | Grundfos Sewage Pumps..... | 379 |
| FRL..... | 623-624 | Molasses..... | 23 | Grundfos Submersible Pumps..... | 401-405 |
| Frostex..... | 338 | Quick Opening..... | 23 | Grundfos Sump Pumps..... | 376 |
| Frostproof Sillcock Repair Kit..... | 263 | Stainless Steel..... | 38 | Guide Arm..... | 223 |
| Fuel Transfer Pump..... | 377 | Gauge, Air and Water..... | 149 | H | |
| Fuel Oil Filters..... | 349 | Gauge, Gas Test..... | 696 | Hacksaw Blades..... | 698 |
| Fuel Oil Pump..... | 347 | Gauge, Industrial..... | 320 | Hacksaws..... | 698 |
| Full Circle Clamps..... | 67 | Gauge, Oil..... | 346 | Hair Trap..... | 221 |
| Fume Scrubbers..... | 626 | Gauge, Pump..... | 434 | Halsey Taylor..... | 246-248 |
| Funnel..... | 215 | Gauge, Water Pressure Test..... | 697 | Hammer Drills..... | 634, 646 |
| Furnace Cement..... | 730 | Gauge Glass..... | 317 | Hammer Flare Tool..... | 673 |
| Furnaces..... | 282 | Gauge Glass Cutter..... | 319, 688 | Hammers..... | 660 |
| Fuseal..... | 593 | Gauge Guard..... | 320 | Hammertrol..... | 370 |
| Fusible Valves..... | 347 | Gauge Sets..... | 317-319 | Hancor..... | 459, 599 |
| Fusion Equipment..... | 460 | Geberit..... | 230 | Hand Sinks..... | 216 |
| -G- | | General Fuel Oil Filter..... | 349 | Hand Trucks..... | 704 |
| Galvanized Pipe Fittings and Nipples..... | 45-56 | General Wire Spring..... | 705-711 | Hand Dryer..... | 191, 235 |
| Galvanized Pump Tanks..... | 437 | Generator Cartridges..... | 295 | Hand Soap..... | 727 |
| Galvanized Straps..... | 128 | George Fisher Valves..... | 604 | Handhole Gaskets..... | 283 |
| Galvanizing Paint..... | 732 | Geotextiles..... | 458 | Handholes..... | 69 |
| Garbage Disposer Tool..... | 684 | Gerber Parts..... | 256 | Handi-Pump..... | 377 |
| Garbage Disposers..... | 264-265 | Gerber Seat Wrench..... | 686 | Handle Puller..... | 684 |
| Garden Hose..... | 100 | Geyser Pumps..... | 376 | Handles..... | 257 |
| Garnet..... | 503 | Glass Filler..... | 160, 249 | Handy Hand..... | 676 |
| Gas Cocks..... | 19 | Glass Lined Retention Tanks..... | 437 | Handy Electric..... | 706 |
| Gas Pipe and Fittings..... | 101-102 | GLOBE VALVES | | Hanger Strapping..... | 128, 603 |
| Gas Pipe, Polyethylene..... | 101 | Bronze, Industrial..... | 12-14 | Hanger Plates..... | 131 |
| Gas Pressure Test Kit..... | 695 | Iron..... | 24 | Hard Hat..... | 691 |
| Gas Quick Connectors..... | 343 | | | | |

| | | | | | |
|--|--------------|---------------------------------------|--------------|----------------------------------|--------------|
| Harmsco Bag Filter..... | 486 | Hydrant Keys..... | 7 | John Guest Fittings..... | 572-573 |
| Harmsco Filters..... | 463, 482-485 | Hydrants..... | 6-7, 154 | Joint Runner..... | 688 |
| Hatco..... | 276 | Hydraulic Hose..... | 616 | Josam Hydrants..... | 7 |
| Hayward Valves..... | 604 | Hydro Zorb..... | 732 | Jumper Cables..... | 716 |
| Hayward Bag Filter..... | 486 | Hydromatic Pumps..... | 382 | | K |
| HDPE Pipe and Fittings..... | 460 | Hydroservant..... | 409 | K Tanks..... | 674, 688 |
| Heaters..... | 690 | Hydrostatic Pressure Pump..... | 668 | Kafer Fittings..... | 106 |
| Heat Exchangers..... | 269 | Hydrovent..... | 315 | KDF..... | 502 |
| Heat Gun..... | 647 | | + | Kinetic Water Ram..... | 683 |
| Heater Hauler..... | 704 | I Tanks..... | 674, 688 | King Nipples..... | 618 |
| Heat Shrink..... | 417 | IBTS..... | 109 | Kitchen..... | 220 |
| Heat Tape..... | 338 | Ice Machine Cleaner..... | 721 | Klein Drains..... | 190 |
| Heat Timer..... | 313 | Ice Maker Installation Kit..... | 211 | Knife Gate Valves..... | 33 |
| Heatproof Grease..... | 728 | Ice Machine Filters..... | 479 | Knife..... | 697 |
| Hex Key Set..... | 689 | Ideal Clamps..... | 611 | Knipex..... | 693 |
| Hide-A-Vector..... | 285 | Identification Tape..... | 691 | Kohler Gaskets..... | 224 |
| High Density Polyethylene Pipe and Fittings..... | 460 | Ignition Cable..... | 345 | Korky Flapper..... | 225 |
| Hoffman..... | 314, 331 | Ignitor Tool..... | 682 | Kunkle Relief Valves..... | 311 |
| Holby..... | 312 | Ignitors..... | 344 | | L |
| Holdz-it..... | 690 | Immersion Wells..... | 292, 316 | Lab Fittings, PVC..... | 592 |
| Hole Saws..... | 636-637 | Index Button Repair Kit..... | 263 | Labcock, PVC..... | 592 |
| Homestead Plug Valves..... | 32 | Infra-Red Heaters..... | 284 | Laboratory Fittings..... | 592 |
| Honeywell Controls..... | 289-290, 292 | Injection Gun..... | 731 | Laboratory Sinks..... | 592 |
| Hook Hose..... | 214 | Insert Fittings, Plastic..... | 610-611 | Laco..... | 722 |
| Hose and Spray..... | 205 | Insert Fittings, Steel..... | 433 | Ladders..... | 702 |
| HOSE | | Insert Fittings, Brass..... | 433 | Lag Screws..... | 131 |
| Air..... | 624 | Insert Fittings, Stainless Steel..... | 432 | Lakos Separators..... | 488 |
| Contractor..... | 100 | Insinkerators..... | 264 | Laminar Flow Aerator..... | 253, 258 |
| Contractors..... | 613 | Inspection Equipment..... | 711 | Land-O-Matic..... | 558 |
| Creamery..... | 613 | Instant Hot..... | 265 | Laundry Trays..... | 217 |
| Discharge..... | 462, 617 | Instant Galvanize..... | 732 | Laundry Tray Faucet..... | 217 |
| Dishwasher..... | 214 | Insulation Shields..... | 128 | Laundry Tray Pumps..... | 378 |
| Fire..... | 154 | Insulation..... | 339-342 | Lavatories..... | 218-220 |
| Fittings..... | 100 | Insulsafe..... | 730 | Lavatory Bracket..... | 215 |
| Garden..... | 100 | Insulation Shield..... | 128 | Lavatory Legs..... | 236 |
| Hook..... | 214 | Internal PVC Pipe Cutter..... | 699 | Lavatory Shield..... | 208 |
| Lay Flat..... | 617 | Internal Spud Wrench..... | 690 | Lay Flat Hose..... | 617 |
| Mill..... | 154 | Internal Tubing Cutter..... | 655 | Lead, Caulking..... | 213 |
| Recoil..... | 624 | Internal Pipe Wrench..... | 700 | Lead Fit All Plug..... | 108, 213 |
| Suction..... | 462, 617 | Iodine..... | 562 | Lead Free Solder..... | 215 |
| Sump Pump..... | 374 | Iron Out..... | 560, 730 | Lead, Pan..... | 213 |
| Tank Truck..... | 462 | Irrigation..... | 601 | Lead, Plugs..... | 108, 213 |
| Washing Machine..... | 214 | | J | Lead Pot..... | 688 |
| Hose Bibbs..... | 6 | J Bend..... | 206, 209 | Lead, Sheet..... | 213 |
| Hose Clamps..... | 611 | J-Hooks..... | 133 | Lead Wool..... | 213 |
| Hose Fittings..... | 100 | Jab Saw, Ridgid..... | 669 | Leak Detector..... | 728 |
| Hose Quick Connects..... | 619 | Jacks Evans Solenoid Valves..... | 28-31 | Leak Lock..... | 725 |
| Hose Reels..... | 616 | Jaco Fittings..... | 574-575, 615 | Leak Repair Plugs..... | 69 |
| Hose Valve Caps..... | 35, 144-148 | Jacuzzi Jet Charger..... | 434 | Level Controls, Pumps..... | 397, 419-420 |
| Hose Valves..... | 35, 144-148 | Jacuzzi Submersible Pumps..... | 406-408 | Level Control..... | 374 |
| HOT..... | 732 | Jacuzzi Pumps..... | 389, 406-408 | Level..... | 654, 697 |
| Hot Water Meter..... | 367 | Jet Charger..... | 434 | Lever Operated Globe Valves..... | 13 |
| Humidifier Installation Kit..... | 211 | Jet Pumps..... | 413-414 | Lever Waste..... | 190 |
| Hurricane Filter..... | 484-485 | Jet Sweat..... | 671 | Lever Waste Tool..... | 684 |
| Hurricane..... | 408 | Jetpaq..... | 415 | Lift Check Valves..... | 13 |
| | | Jig Saw & Blades..... | 636, 644 | Lift Wire..... | 226 |

| | | | | | |
|----------------------------------|-------------------|------------------------------------|------------|----------------------------------|------------------|
| Light Bulbs..... | 717 | Micromet..... | 730 | No Hub Torque Wrench..... | 111, 690 |
| Lighting Surge Arrestor..... | 420 | Mill Hose..... | 154 | No Hub Couplings..... | 111 |
| Lil Nipper..... | 699 | Milwaukee Tools..... | 629-647 | No Seep..... | 224 |
| Lime Solvent..... | 721 | Mini Saw..... | 698 | Nokorode..... | 722 |
| Liquid Wrench..... | 724 | Mini-Trol..... | 370 | Non-Asbestos Packing..... | 73 |
| Liquid Filtration Unit..... | 456 | Mini-Rooter..... | 708 | Non-Clog Pumps..... | 390 |
| Liquid Level Control..... | 374, 383 | Mirrors..... | 235 | Normac Fittings..... | 101 |
| Little Giant Pumps..... | 384-386 | Mission Couplings..... | 103-104 | Nozzles..... | 100, 154, 350 |
| Little Giant Sump Pumps..... | 375 | Mitsubishi..... | 541 | Nozzle, Strahman..... | 616 |
| Locator Tape..... | 102 | Mixers..... | 551 | Nutcracker..... | 685 |
| Locking Plugs..... | 449 | Mixing Valves, Heat..... | 312 | Nuts..... | 59, 131, 138 |
| Lonergan Relief Valves..... | 311 | Mixing Valves..... | 174-180 | Nut Driver Set..... | 648 |
| Loose Key Vent..... | 313 | Modine..... | 285 | Nut Splitter..... | 689 |
| Lovejoy Couplings..... | 395 | Moen..... | 182-184 | Nylon Barbed Fittings..... | 614 |
| Lube Oil..... | 724 | Moen Cartridge Puller..... | 685 | Nylon Compression Fittings..... | 574-575, 615 |
| Lubricator, Air..... | 623 | Monitor Pitless Adapter..... | 427 | Nylon Tube Fittings..... | 574-575, 614-615 |
| | -M- | Monitoring Well Accessories..... | 449 | | -O- |
| Mack Gasket..... | 205 | Monitoring Well Manholes..... | 438, 449 | O-Ring Kit..... | 263 |
| Magnet..... | 697 | Monoflo Tee..... | 348 | O-Ring Making Kit..... | 681 |
| Magnetic Drill Chuck..... | 689 | Mop Basin..... | 217 | O-Ring Pick Kit..... | 681 |
| Magnetic Pick Up..... | 697 | Muesco Valves..... | 355 | O-Rings..... | 260 |
| Magnetic Starters..... | 424 | Multi-Media..... | 502 | Oakum..... | 113, 215 |
| Magnum..... | 506, 520 | Multi-Stage Pumps..... | 392 | Oasis Cooler Parts..... | 250 |
| Main Control Gas Valve..... | 331 | Muriatic Acid..... | 721 | Observation Ports..... | 317 |
| Malleable Pipe Fittings..... | 45-51 | Mushroom Vent, Oil..... | 348 | Odor-X..... | 732 |
| Manganese Greensand..... | 502 | Mushroom Vent, Cast Iron..... | 107 | Offset..... | 206, 209 |
| Manhole..... | 107-108, 438, 449 | Mushroom Vent, PVC..... | 597 | Oil Burner Nozzles..... | 350 |
| Manhole Cover..... | 108 | MVB Ballcock..... | 226 | Oil Dry..... | 732 |
| Manhole Gaskets..... | 283 | Myers Pumps..... | 387 | Oil Filter Cartridges..... | 349 |
| Manhole Opening..... | 69 | Myson..... | 287 | Oil Filters..... | 349 |
| Manometer..... | 695 | | -N- | Oil Tanks..... | 345 |
| Mansfield Flush Valve..... | 228 | NDS Drain and Fittings..... | 600-602 | Oil/Water Separators..... | 452-453 |
| Mapp Gas..... | 674 | Needle Valves..... | 4, 37 | One Ear Clamps..... | 128 |
| Marq II..... | 688 | Neoprene Gasket Material..... | 73 | Optima..... | 192, 196, 201 |
| Mask..... | 691 | Nice-N-Icy..... | 479 | Orifice Drills..... | 695 |
| Masonry Bits..... | 649 | NIPPLES | | Orion..... | 593 |
| Masonry Drill Bits..... | 649 | Aluminum..... | 83 | Otterbine Fountains..... | 468 |
| Match Holder..... | 695 | Brass..... | 71 | Overflow Tubes..... | 223 |
| Material Handling Equipment..... | 703-704 | Chrome Plated Brass..... | 99 | Overflow Washers..... | 259 |
| Maxi Vent..... | 211 | Combination..... | 618 | Oxygen Service Valves..... | 32 |
| MC Tank..... | 674 | CPVC..... | 590 | Oxygen Tank..... | 674 |
| McDonnel Miller..... | 321-324 | Hose..... | 100, 618 | | -P- |
| McPherson Toilet..... | 231 | King..... | 618 | P Trap, Tubular..... | 206-209 |
| Mec-O-Matic Pumps..... | 543-556 | PVC..... | 590 | Packing and Gasket Material..... | 73 |
| Media..... | 502-503 | Runs, Steel, Brass, Plastic..... | 56 | Packing Hooks..... | 681 |
| Medic-Aid Seats..... | 222 | Runs, Chrome, Stainless Steel..... | 56 | PACO Pumps..... | 387 |
| Mercury Switch..... | 583 | Stainless Steel..... | 81 | Pails..... | 691 |
| Metal Cutting Shear..... | 647 | Steel, Black and Galvanized..... | 52-55 | Pallet Jack..... | 703 |
| Meter Box..... | 368 | Tote Tray..... | 675 | Pan Cement..... | 210 |
| Meter Box..... | 599 | Nipple Box..... | 682 | Park Tanks..... | 530-531 |
| Meter Couplings..... | 367 | Nipple Extractors, PVC..... | 699 | Partitions..... | 232-234 |
| Meter Setter..... | 368 | No Burst Connectors..... | 212 | Partition Hardware..... | 232-234 |
| Meter Washers..... | 367 | No Caulk Closet Flange..... | 105 | Patching Cement..... | 722 |
| Meter Yoke..... | 368 | No Freeze..... | 30, 732 | Pear Hangers..... | 130 |
| Meters..... | 367-368 | No Freeze Hydrants..... | 5-7 | Penetrating Oil..... | 724 |
| Metering Pumps..... | 543-556 | | | | |

| | | | | | |
|--|----------|--|--------------|-------------------------------|--------------------|
| Perma Cement..... | 722 | Pipe Holder..... | 425 | Pressure Controls..... | 294 |
| Permacore Stem..... | 256 | Pipe Joint Compound..... | 725 | Pressure Powered Pumps..... | 330 |
| Permatex..... | 723 | Pipe Outside Diameter Guide..... | 64 | Pressure Pump..... | 668 |
| Petcocks..... | 8 | Pipe Protection Tape..... | 729 | Pressure Switches, Pumps..... | 396, 419 |
| Peterson Flusher..... | 672 | Pipe Rollers..... | 137-138 | Pressure Motive Pumps..... | 330 |
| Phenoseal..... | 724 | Pipe Straps..... | 128 | Propane Tanks..... | 674, 688 |
| Philadelphia Vent Box..... | 107 | Pipe Thawers..... | 700 | Proportional Feeder..... | 557 |
| Pick Up Tool..... | 676 | Pipe Vises..... | 658-659 | Protector Relay..... | 293 |
| Pig Tails..... | 317 | Pipe Weights and Wall Thicknesses..... | 62 | Pulsafeeder..... | 543-556 |
| Pilot Burners..... | 295 | Pipe Wrap Primer..... | 729 | Pulsatron..... | 548 |
| Pilot Drills..... | 636 | Pipe Wrap Tape..... | 434 | PUMPS | |
| Pilot Module..... | 294 | Pitcher Pump..... | 377 | Bell & Gossett..... | 301-302, 393-394 |
| Pilot Operated Pressure Regulators, Water..... | 355 | Pitless Adapters..... | 426-427 | Booster..... | 389-392 |
| Pilot Operated Pressure Regulators, Steam..... | 325 | Plastic Grid..... | 527 | Centrifugal..... | 388-394 |
| Pilot Valve..... | 331 | Plastic Hanger..... | 603 | Circulators..... | 298-302 |
| Pin Vise..... | 695 | Plastic Insert Fittings..... | 610-611 | Condensate, Steam..... | 331 |
| Pinch Valves..... | 33 | Plastomatic Valves..... | 605-606 | Condensate, Water..... | 386 |
| Pinchoff Tool..... | 696 | Plastic Pipe Tools..... | 651-652 | Effluent..... | 382 |
| PIPE | | Plastic Valve Box..... | 599 | Geyser..... | 376 |
| Alloy..... | 83 | Plastic Valves..... | 603-607 | Grundfos, Circulators..... | 299-301 |
| Aluminum..... | 83 | Pliers, Ridgid..... | 692 | Grundfos, Sewage..... | 379 |
| Brass..... | 63 | Pliers..... | 692-693 | Grundfos, Submersible..... | 401-405 |
| Chrome Plated..... | 63 | Plug Valves..... | 32 | Grundfos, Sump..... | 376 |
| Corrugated Plastic..... | 599 | Plumb Bob..... | 690 | Grundfos, Environmental..... | 441-448 |
| CPVC, Sch 80..... | 587 | Plumber's Candle..... | 697 | Grundfos, Jet..... | 413 |
| Culvert, Steel..... | 69 | Plumber's Paste..... | 726 | Grundfos, Industrial..... | 391 |
| Culvert, Plastic..... | 599 | Plumber's Roll..... | 678 | Hydromatic..... | 381 |
| Double Containment..... | 448 | Plumber's Seal..... | 726 | Jacuzzi..... | 389, 406-408 |
| Extra Heavy Steel..... | 63 | Plunger Discs..... | 690 | Laundry Tray..... | 378 |
| Extrucoat..... | 63 | Plungers..... | 690 | Little Giant..... | 384-386 |
| Gastite..... | 102 | PO Plug..... | 205 | Pony..... | 377 |
| Gas..... | 101-102 | Poly Pipe..... | 610 | Pool Cover..... | 384 |
| Glass..... | 63 | Poly Glass Tanks..... | 530-531 | Pool..... | 389 |
| Hastelloy..... | 83 | Polybutylene..... | 571 | Red Jacket..... | 411 |
| HDPE..... | 460 | Polycel..... | 723 | Redi-Flo..... | 441-448 |
| High Density Polyethylene..... | 460 | Polyester Tanks..... | 531 | Seals..... | 395 |
| Inconel..... | 83 | Polyethylene Drainage Pipe..... | 459, 599 | Sewage..... | 379-380 |
| Lined..... | 63 | Polyethylene Pipe..... | 610 | Sump..... | 373-376 |
| Monel..... | 83 | Polymeter..... | 367 | Taco..... | 298-299 |
| Polyethylene..... | 610 | Polypropylene Pipe and Fittings..... | 593 | Well Pumps..... | 399-415 |
| Polypropylene..... | 593 | Pony Pump..... | 377 | Pumptrol..... | 396 |
| PVC, Sch 80..... | 586 | Pool Cover Pump..... | 384 | Pump Check Valves..... | 429-431 |
| PVC, Sch 40..... | 581 | Pool Pumps..... | 389 | Pump Controls..... | 383 |
| PVC-DWV..... | 581 | Pop Safety Valves..... | 311, 331 | PUMP CONTROLS | |
| SDR 35..... | 598 | Pop Up..... | 205 | Control Boxes..... | 424 |
| Seamless..... | 63 | Pop-Up Repair Kit..... | 263 | Coyote..... | 420 |
| Sewer and Drain..... | 597 | Potassium Chloride..... | 560 | Level..... | 374, 397, 419-420 |
| Smoke..... | 335 | Potassium Permanganate..... | 561 | Pump Tec..... | 421 |
| Stainless Steel..... | 83 | Powers..... | 174-180, 201 | Switches..... | 396, 398, 416, 419 |
| Steel..... | 63 | Power Drive, Ridgid..... | 663 | Tank Alarm..... | 383 |
| Pipe-N-Hot..... | 700 | Power Strut..... | 132 | Pump Control Boxes..... | 424 |
| Pipe Cutters, Ridgid..... | 662 | Powers Tool..... | 685 | Pump Couplings..... | 299, 395 |
| Pipe Cutters..... | 650, 662 | Power Venter..... | 336 | Pump Gauges..... | 434 |
| Pipe Dies..... | 656-657 | Power Wrap..... | 670 | Pump Puller..... | 427-428 |
| Pipe Extractor..... | 700 | Pre-Rinse..... | 157-170 | Pump Relief Valves..... | 327, 429 |

| | | | | | |
|-----------------------------------|------------|--|-----------------------|---------------------------------|--------------|
| Pump Seals..... | 395 | Refill Tube..... | 223 | Riser Clamps..... | 129 |
| Pump Stand..... | 435 | Refrigerator..... | 220 | RO Mate Tanks..... | 564 |
| Pump Tec..... | 421 | Refrigerant Recovery System, Ridgid..... | 668 | Rod Couplings..... | 131 |
| Pump Wire..... | 416-418 | Refrigeration Tubing..... | 84-85 | Rohm & Haas Resin..... | 541 |
| Pure Gold Bentonite..... | 438 | Regulators, Air..... | 624 | Root Destroyer..... | 721 |
| Purge and Balancing Valves..... | 305 | REGULATORS | | Roof Drain, PVC..... | 596 |
| Purolite..... | 533-541 | Air..... | 624 | Roof Drains..... | 221 |
| Putty..... | 722 | Bell & Gossett..... | 306 | Roof Flashing Cement..... | 728 |
| PVC Cements..... | 608 | Braukman..... | 306 | Roof Flashing..... | 211 |
| PVC Fittings, Sch 80..... | 584-586 | Cash Acme..... | 309 | Rope, Pump..... | 425 |
| PVC Fittings, Sch 40..... | 581-583 | Dole..... | 364-366 | Rotary Joint..... | 87 |
| PVC Inside Pipe Cutter..... | 699 | Fire Protection Pressure Regulators..... | 143-145 | Router..... | 647 |
| PVC Nipples..... | 590 | Flow..... | 364-366 | Rubatex..... | 339, 342 |
| PVC Pipe, Sch 80..... | 586 | Gas..... | 343 | Rubber Bleeder..... | 425 |
| PVC Pipe, Sch 40..... | 581 | Pilot Operated, Steam..... | 325 | Rubber Expansion Joints..... | 124 |
| PVC Tape..... | 342 | Pilot Operated, Water..... | 355 | Rulers..... | 669 |
| PVC Tools..... | 699 | Steam..... | 325, 328 | Rusco Filter..... | 487 |
| PVC Welding Rod..... | 594 | Temperature..... | 328 | | |
| Pyrolox..... | 502 | Water..... | 329, 355 | | |
| | -Q- | Watson McDaniel..... | 325 | S Trap, Tubular..... | 206-209 |
| Oest..... | 571 | Watts..... | 309, 355 | Saddle Fittings, Cast Iron..... | 106 |
| Quartzes..... | 567 | Reinforced Vinyl Tubing..... | 612 | Saddles, Plastic..... | 603 |
| Quick Connects, Gas..... | 343 | Relays..... | 290-291, 293-295, 300 | Saddle Tee, PVC..... | 596 |
| Quick Connects, Water..... | 619 | RELIEF VALVES | | Saddle Tee..... | 57 |
| Quick Connects, Hose..... | 619 | Air..... | 623 | Saddle Valve..... | 211 |
| Quick Connects, Air..... | 625 | ASME..... | 308, 310-311 | Safe..... | 731 |
| Quick Fix..... | 332-333 | Back Pressure..... | 327 | Safety Anvil..... | 695 |
| Quick John..... | 231 | Consolidated..... | 311 | Safety Equipment..... | 251 |
| Quick Nutcracker..... | 685 | Hot Water Boiler..... | 308 | Safety Rope..... | 425 |
| Quick Sweat..... | 671 | Kunkle..... | 311 | Safety Tools..... | 691 |
| | -R- | Lonerger..... | 311 | Safety Valves..... | 308, 310-311 |
| R Relief Valves..... | 327 | Lunkenheimer..... | 311 | Salt..... | 560, 730 |
| R Tank..... | 674 | Pop Safety..... | 331 | Salt Grid..... | 527 |
| Radiant Heating..... | 288 | Pump..... | 327 | Sand Cloth..... | 678 |
| Radiators..... | 287 | PVC..... | 605-606 | Sand..... | 503 |
| Radiator Elbow..... | 348 | "R"..... | 327 | Sander..... | 645 |
| Radiator Handles..... | 344 | Steam..... | 331 | Sandhandler..... | 406-407 |
| Radiator Traps..... | 327 | Temperature and Pressure..... | 308 | Sandmaster..... | 488 |
| Radiator Valves..... | 297, 348 | Water Heater..... | 278 | Sanitary Napkin Dispenser..... | 235 |
| Radon Removal Equipment..... | 576-577 | Watts..... | 308, 310 | Sarco..... | 326-333 |
| Railing Fittings..... | 80 | Well Pump..... | 429 | Saws..... | 669, 698 |
| Rain Suit..... | 691 | Repair Clamps and Couplings..... | 66-67 | Sawzall..... | 639-641 |
| Ram Bit..... | 699 | Repair Plate..... | 106 | Schrader Valve..... | 425 |
| Range Boilers..... | 301 | Replacement Straps..... | 667 | Scotch Marine Boilers..... | 283 |
| Ratchet Wrench..... | 649 | Res Up..... | 561 | Scraper, Pipe..... | 67 |
| Rawl..... | 134-135 | Reseater Tool..... | 683 | Scratch Brushes..... | 679 |
| Reamer, Ridgid..... | 663 | Resin..... | 533-541 | Screens, Strainers..... | 114 |
| Recoil Hose..... | 624 | Retard Chamber..... | 149 | Screw Removal Tool..... | 689 |
| Rectorseal..... | 725 | Retention Tanks, Water Treatment..... | 563 | Screwdriver Set..... | 648 |
| Red Jacket Submersible Pumps..... | 411 | Retention Tanks, Well Pump..... | 437 | Screwdriver Set (Fold Up)..... | 689 |
| Red Rubber..... | 73 | Reverse Osmosis..... | 568-570 | Screwgun..... | 647 |
| Redi-Flo Converter..... | 446 | Reznor Hooks..... | 128 | Scrub Sink..... | 201 |
| Redi-Flo Parts..... | 448 | Ridgid Hammers..... | 660 | Scrubs..... | 727 |
| Redi-Flo Pumps..... | 441-448 | Ridgid Tubing Cutters..... | 652-653 | Scullery Sinks..... | 216 |
| Reelcraft..... | 616 | Rinse Quick..... | 205 | Scully..... | 346 |
| | | | | SDR-35 Pipe and Fittings..... | 598 |

| | | | | | |
|--------------------------------------|-------------------|---------------------------------------|--------------|-----------------------------|-----------------------|
| Seals, Pump..... | 395 | Slip Joint Washers..... | 259 | Spuds..... | 228 |
| Seals, Well..... | 428 | Slip Joint Fittings..... | 207, 209 | Square D Switches..... | 396-398, 419 |
| Seat Tools..... | 686 | Slip Joint Nuts..... | 207, 209 | Squick..... | 731 |
| Sediment Cartridges..... | 475-476 | Sloan Super Wrench..... | 685 | Sta-Clean..... | 722 |
| Sediment Trapper..... | 487 | Sloan Valve..... | 191-203 | Sta-Rite Pumps..... | 387-388 |
| Self-Feed Bits..... | 635 | Slotted Angle..... | 135 | Stadler..... | 288 |
| Self Tapping Boiler Plugs..... | 344 | Sludge Kleen..... | 728 | STAINLESS STEEL | |
| Separators..... | 488 | Smart Dumbbell..... | 685 | Ball Valves..... | 115 |
| Septic Tank Activator..... | 721 | Smith Blair Clamps and Couplings..... | 67 | Cartridge Filters..... | 481-488 |
| Service Sinks..... | 216 | Smith Gaskets..... | 224 | Clamps..... | 611 |
| Sewage Pump Check Valves..... | 431 | Smith Hydrants..... | 7 | Fittings and Nipples..... | 81-83 |
| Sewage Pumps..... | 379-380 | Smith Mills..... | 283 | Floats..... | 20 |
| Sewage Pump Alarm..... | 383 | Smitty Plate..... | 188 | Foot Valves..... | 432 |
| Sewer and Drain Pipe & Fittings..... | 597 | Smoke Pipe..... | 335 | Insert Fittings..... | 432 |
| Sewer Machines..... | 705-715 | Snake Oil..... | 707 | Nuts and Bolts..... | 138 |
| Sewer Main Fittings, PVC..... | 598 | Snap Aerator..... | 258 | Pipe..... | 83 |
| Sewer Rods..... | 707 | Snappy Pitless Adapter..... | 426 | Pump Check Valves..... | 432 |
| Shank Couplings..... | 618 | Snips..... | 694 | Sinks..... | 216 |
| Shank Extension..... | 635 | Snoop..... | 729 | Supply Connectors..... | 212 |
| Sheet Metal Tools..... | 694 | Snorkel Gauge..... | 346 | Stakon..... | 417 |
| Shock Suppressors..... | 370 | Snubber..... | 320 | Stall Showers..... | 239 |
| Shovels, Ridgid..... | 669 | Soap Dish..... | 236 | Stall Shower Valve..... | 242 |
| Shower Arm..... | 242 | Soap Dispenser..... | 205, 235-236 | Standard Kiel Drains..... | 190 |
| Shower Bases..... | 239 | Socket Weld Fittings..... | 75 | Steam Condensate Pumps..... | 331 |
| Shower Curtain Pins..... | 243 | Socket Wrench Set..... | 684 | Steam Hose..... | 616 |
| Shower Doors..... | 240 | Soda Ash..... | 562 | Steam Regulators..... | 325 |
| Shower Drain, PVC..... | 210, 596 | Soda Sesquicarbonate..... | 562 | Steam Safety Valves..... | 311 |
| Shower Drain, Cast Iron..... | 108 | Soil Pipe Cutter, Ridgid..... | 664 | Steam Trap Repair Kits..... | 330, 332-333 |
| Shower Heads..... | 241-242, 244 | Soil Pipe and Fittings..... | 110-113 | Steam Traps..... | 326-327, 330, 332-333 |
| Shower Mate..... | 242 | Soil Pipe Gaskets..... | 113 | Steam Vent..... | 313-315 |
| Shower Pan Cement..... | 210 | Soil Pipe Tools..... | 111 | Steel Wool..... | 678 |
| Shower Pan..... | 210 | Soil Seal..... | 730 | Steel Insert Fittings..... | 433 |
| Shower Rods..... | 242-243 | Solar Salt..... | 560, 730 | Steel Pipe..... | 63 |
| Shower Tower..... | 240, 252 | Solder..... | 215 | Stenner..... | 552-556 |
| Shower Trap, Cast Iron..... | 107 | Soldering Hoses..... | 675-677 | Step Ladders..... | 702 |
| Shower Valves..... | 171, 183, 185-186 | Soldering Kits..... | 675-677 | Sterling Parts..... | 255 |
| Shower Walls..... | 240 | Soldering Tips..... | 675, 677 | Stop and Waste Valves..... | 3, 5 |
| Sight Glass..... | 317-319 | Soldering Tools..... | 674-677 | Stop Cock Key..... | 697 |
| Silicone..... | 730 | Solvents, PVC..... | 608 | Stop Valves..... | 3 |
| Silicone Caulking..... | 724 | Solenoid Valves..... | 28-31, 293 | Stove..... | 220 |
| Silicone Gasket..... | 723 | Soot Scoot..... | 732 | Strahman Nozzle..... | 616 |
| Sillcock Key..... | 684 | Space Heaters..... | 285 | Strainer Wrench..... | 685 |
| Sillcocks..... | 5-7 | Spanner Flange..... | 230 | STRAINERS | |
| Silver King..... | 731 | Speakman Faucet Parts..... | 253 | Duplex..... | 116 |
| Silverflow..... | 677 | Speakman..... | 201 | Bronze..... | 114-116 |
| Simplex Strainers..... | 116 | Spindown Filter..... | 487 | Cast Iron..... | 115 |
| Sink Clips..... | 215 | Spiralink..... | 303 | Duo..... | 204 |
| Sink Drains, Commercial..... | 190 | Spirotop..... | 307 | Grid..... | 205 |
| Sinks, Hand..... | 216 | Split Ring Hangers..... | 129 | Sink..... | 204 |
| Sinks, Scullery..... | 216 | Sprinkler Heads and Trim..... | 149 | Bar Sink..... | 205 |
| Sinks, Stainless Steel..... | 216 | Sproivent..... | 307 | Mesh Guide..... | 114 |
| Sink Stopper..... | 265 | Sprocket Rims..... | 41 | Simplex..... | 116 |
| Sisson Joint..... | 106 | Spud Key..... | 686 | Y Type, Stainless..... | 115 |
| Skinner Clamps..... | 68 | Spud Washers..... | 228 | Y Type, Bronze..... | 115 |
| Slic-Tite..... | 725 | Spud Wrench..... | 683 | Y Type, Cast Iron..... | 115 |

| | | | | | |
|-------------------------------------|----------|--------------------------------|----------|-----------------------------------|-----------------------|
| Strap Wrench Parts, Ridgid..... | 667 | RO Mate..... | 564 | Thermometer Wells..... | 292, 316 |
| Strap Wrenches..... | 662, 667 | Sprayer..... | 462 | Thermometers..... | 316 |
| Strapping..... | 128 | Structural Fiber..... | 530-531 | Thermostat Boxes..... | 296 |
| Striker..... | 674 | Tractor Mount..... | 462 | Thermostat Cable..... | 344 |
| Structural Fiber Tanks..... | 530-531 | Truck..... | 462 | Thermostat Guards..... | 296 |
| Strut..... | 132 | Water Treatment Retention..... | 563 | Thermostat, Heating/Cooling..... | 289, 296 |
| Subguard..... | 420 | Water Heater Storage..... | 274 | Thermostats, Water Heater..... | 278 |
| Submersible Pump Control Boxes..... | 424 | Well X-Trol..... | 435-436 | Thermostatic Radiator Valves..... | 297 |
| Submersible Pump Motors..... | 422-423 | Well Mate..... | 564 | Thermostatic Steam Traps..... | 327 |
| Submersible Well Pumps..... | 399-415 | X-Trol..... | 435-439 | Thread Gauge..... | 690 |
| Submersible Pump Cable..... | 416-418 | Tank Alert..... | 383 | Thread Cutting Oil..... | 728 |
| Suction Hose..... | 617 | Tank Balls..... | 225 | Threaded Rod..... | 131 |
| Suction Strainers..... | 618 | Tank Bushings..... | 348 | Threaders..... | 656, 659 |
| Suction Tee..... | 328 | Tank Cover..... | 230 | Threading Machines, Ridgid..... | 664-666 |
| Sump Pit..... | 374 | Tank Cross..... | 435 | Threadolet..... | 79 |
| Sump Pump Check Valve..... | 374 | Tank Drains..... | 305 | Thrush Pumps..... | 387 |
| Sump Pump Hose Kit..... | 374 | Tank Elbow..... | 228 | Tip Toe Cartridge..... | 201 |
| Sump Pumps..... | 373-376 | Tank Fittings and Valves..... | 346, 348 | Tissue Dispenser..... | 236 |
| Sunroc..... | 246-248 | Tank Fittings, PVC..... | 592 | Tite Seal Gaskets..... | 113 |
| Sunroc Cartridge..... | 250 | Tank Jackets..... | 532 | Tite Seal Lubricant..... | 113 |
| Sunroc Parts..... | 250 | Tank Legs..... | 437 | Tite Seal Lube..... | 729 |
| Super Vee..... | 706 | Tank Levers..... | 229, 231 | Titeflex..... | 102 |
| Super Wrench..... | 685 | Tank Liner..... | 230 | Toggle Bolts..... | 134-135 |
| Super Lav/Closet Supplies..... | 212 | Tank Stand..... | 435 | Toilets..... | 218-220 |
| Supply Tubes, Lavatory..... | 210 | Tank Sticks..... | 344 | Toilet Floats..... | 227 |
| Supply Tubes, Plastic..... | 607 | Tank Tee..... | 435 | Toilet Paper Dispenser..... | 236 |
| Sure-Flex Couplings..... | 299 | Tank to Bowl Gaskets..... | 228 | Toilet Partitions..... | 232-234 |
| Surefire..... | 674 | Tank to Bowl Bolts..... | 223 | Toilet Seats..... | 222 |
| Surge Arrestor..... | 420 | Tank Valves..... | 348 | Toilet Tank Replacement..... | 230 |
| Suspension Wire..... | 419 | Tap and Die Set..... | 649 | Tool Tote..... | 698 |
| Swaging Tool..... | 654, 673 | Tap, Bibb Screw..... | 259 | Top Beam Clamps..... | 130 |
| Swivel Joints..... | 97 | Tap & Drill Set..... | 648 | Torches and Tips..... | 674-678 |
| Swivel Ring Hangers..... | 130 | Tape Measures, Ridgid..... | 669 | Torque Wrench, Ridgid..... | 664 |
| Symmons Valves..... | 181 | Tapping Machine..... | 650 | Torque Arrestor..... | 425 |
| Syphons..... | 317 | Taps..... | 700 | Torque Wrench..... | 111, 681 |
| | | Tarp..... | 690 | Touch Flow..... | 205 |
| | | Taste and Odor Cartridges..... | 476-478 | Tough Tank..... | 345 |
| | | T.D. Steam Traps..... | 326 | Towel Bars..... | 236 |
| | | Teeny Weeny Saw..... | 698 | Towel Dispenser..... | 235 |
| | | Teflon Tape, Gas..... | 101, 343 | Trace-A-Leak..... | 724 |
| | | Teflon Tape..... | 726-727 | Trap Spoon..... | 710 |
| | | Teflon Packing..... | 73 | Trap Ferrule..... | 109 |
| | | Tek Driver..... | 647 | Traps, Tubular..... | 206-209 |
| | | Tek Screws..... | 689 | Traps, Steam..... | 326-327, 330, 332-333 |
| | | Telescopic Claw..... | 676 | Trench Drain, PVC..... | 600 |
| | | Tempering Valves..... | 312 | Tri-Cock..... | 317 |
| | | Temple Hangers..... | 133 | Trip Lever..... | 245 |
| | | Testers..... | 716 | Trip Plate..... | 245 |
| | | Test Caps..... | 688 | Trip Waste..... | 171 |
| | | Test Gauge, Gas..... | 696 | Triple Seal..... | 225 |
| | | Test Gauge, Water..... | 697 | Trouble Lights..... | 717 |
| | | Test Plugs..... | 672, 688 | Truck Racks..... | 701 |
| | | Therm-X-Trol..... | 370 | True Union Ball Valve..... | 604 |
| | | Thermo-Trap..... | 729 | T&S..... | 157-170, 201 |
| | | Thermocouple..... | 344 | Tub and Shower Valves..... | 171, 183, 185-186 |
| | | | | | |

-T-

| | |
|----------------------------|-------------------|
| T Handle Hex Key..... | 690 |
| T&S..... | 157-170, 201 |
| Taco Controls..... | 291 |
| Taco Circulator Pumps..... | 298-299 |
| Tail Pieces, Tubular..... | 206, 209 |
| Tailpiece Washers..... | 259 |
| TANKS | |
| Brine..... | 528-539 |
| Bulk Storage..... | 462 |
| Epoxy Coated..... | 437 |
| Fiberglass..... | 462, 530-531, 563 |
| Galvanized..... | 437 |
| Glass Lined..... | 437 |
| Mineral Tanks..... | 530-531 |
| Park..... | 530-531 |
| Poly Glass..... | 530-531 |
| Polyester..... | 531 |
| Polyethylene..... | 462 |
| Retention..... | 437, 563 |

| | |
|-------------------------------|----------|
| Tub and Shower Enclosure..... | 238, 240 |
| Tub Doors..... | 240 |
| Tub Spouts..... | 245 |
| Tub Walls..... | 240 |
| Tub Waste..... | 171 |
| Tube Benders..... | 650, 655 |
| Tube Brushes..... | 680 |
| Tube Bundles..... | 269 |
| Tube Plugs..... | 269 |

TUBING

| | |
|---------------------------|----------|
| Aluminum..... | 122 |
| Copper..... | 84-85 |
| CPVC..... | 607 |
| Hydraulic..... | 616 |
| Polybutylene..... | 571 |
| Polyethylene..... | 572, 613 |
| Quest..... | 571 |
| Reinforced Vinyl..... | 613 |
| Steam..... | 616 |
| Vinyl..... | 612 |
| Tubing Brush..... | 678 |
| Tubing Cutter Wheels..... | 653 |
| Tubing Straps..... | 128 |
| Tubs..... | 220, 238 |
| Tubular Brass..... | 206-208 |
| Turbine Pumps..... | 390 |
| Turbo Torch..... | 676-677 |
| Turf Box..... | 599 |

U-

| | |
|---|----------|
| U-Bolts..... | 130 |
| Ultraviolet Lights..... | 565-567 |
| Unifill Fittings..... | 346 |
| Unistrut..... | 132 |
| Unit Heaters..... | 285 |
| Universal Rundle Flush Valve..... | 227 |
| Up Flush Toilet..... | 231 |
| Up-Z-Dazy..... | 427 |
| Upflow Filters..... | 500 |
| Urinals..... | 218-220 |
| Urinal Blocks..... | 230 |
| Urinal Flange, PVC..... | 507 |
| Urinal Gaskets..... | 224, 259 |
| Urinal Plug..... | 211 |
| Urinal Screen..... | 230 |
| Urinal Strainer, American Standard..... | 201 |
| Urinal Strainer, Kohler..... | 201 |
| Urn Faucet..... | 190 |
| US Seal..... | 395 |
| Utility Shower..... | 243 |
| Utility Knife..... | 697 |
| UV Lights..... | 565-567 |

V-

| | |
|----------------------------|---------|
| Vacuum Breaker, Steam..... | 314 |
| Vacuum Breakers..... | 356-358 |
| Valve Key..... | 697 |

| | |
|------------------|-----|
| Valve Boxes..... | 599 |
|------------------|-----|

VALVES

| | |
|----------------------------|-----------------------|
| AWWA..... | 39 |
| Ball..... | 15-18 |
| Boiler..... | 25, 34-35 |
| Bronze and Iron..... | 12-18, 24 |
| Butterfly..... | 26-27, 604 |
| Cast Steel..... | 42 |
| Chrome Plated..... | 99 |
| Compact Pattern..... | 5 |
| Cryogenic..... | 42 |
| Diaphragm..... | 33 |
| Everlasting..... | 34 |
| Fire Protection..... | 35, 144-148 |
| Flare and Compression..... | 8 |
| Float and Fill..... | 20-22 |
| Flomatic..... | 430-431 |
| Flow Characteristics..... | 10 |
| Foot..... | 25, 429-430, 432, 618 |
| Forged Steel..... | 36-37 |
| Fusible..... | 347 |
| Gas..... | 19 |
| Hydrants..... | 7 |
| Industrial..... | 12-18 |
| Installation Tips..... | 11 |
| Knife..... | 33 |
| Needle..... | 4, 37 |
| Oxygen Service..... | 32 |
| Pinch..... | 33 |
| Plug..... | 32 |
| Plumbing..... | 3 |
| Selection Guide..... | 9-10 |
| Silent Check..... | 25 |
| Solenoid..... | 28-31 |
| Stainless Steel..... | 38 |
| Stop and Check..... | 25 |
| Tank..... | 348 |
| Water Service..... | 4 |
| Yarway..... | 35 |
| Van Hangers..... | 133 |
| Vandal Proof Showers..... | 241 |
| Vanities..... | 220 |
| Vapor Filtration Unit..... | 456 |
| Vent Alarm..... | 346 |
| Vent Cap..... | 348 |
| Vent Box, Cast Iron..... | 107 |
| Vents, Water..... | 313-315 |
| Vents, Steam..... | 313-315 |
| Venturi Male Adapter..... | 433 |
| Vessel Openings..... | 69 |
| Victaulic Fittings..... | 81, 152 |
| Viking Coil Cleaner..... | 732 |
| Vinyl Tubing..... | 612 |
| Voltage Tester..... | 716 |

-W-

| | |
|---|-------------------|
| Walky Talky..... | 649 |
| Wash Basin..... | 252 |
| Wash Down Hose..... | 611 |
| Washer Trimmer..... | 684 |
| WASHERS | |
| Bibb..... | 259 |
| Faucet..... | 259 |
| Heater Element..... | 278 |
| Hose..... | 100 |
| Kits..... | 261-263 |
| Meter..... | 367 |
| Overflow..... | 259 |
| Shank Coupling..... | 618 |
| Slip Joint..... | 259 |
| Tailpiece..... | 259 |
| Washers..... | 59, 131, 138, 259 |
| Washing Machine Accessories..... | 214 |
| Washing Machine Box..... | 214 |
| Washing Machine Connectors..... | 212 |
| Washing Machine Hose..... | 214 |
| Washing Machine Pan..... | 214 |
| Washing Machine Shut Off..... | 214 |
| Washroom Accessories..... | 235-236 |
| Wasp and Hornet Killer..... | 729 |
| Waste and Overflow..... | 171 |
| Waste and Overflow Repair Kit..... | 263 |
| Waste Receptacle..... | 235 |
| Watch-Call It Kit..... | 649 |
| Watchman Condensate Pump..... | 331 |
| Water Box, Cast Iron..... | 107 |
| Water Coolers..... | 246-247 |
| Water Hammer..... | 370 |
| Water Heater Storage Tank..... | 274 |
| Water Heater Accessories..... | 278 |
| Water Heater Connectors..... | 212 |
| Water Heater Element Socket..... | 685 |
| Water Heaters..... | 270-277 |
| Water Meters..... | 367 |
| Water Pressure Regulators..... | 355 |
| Water Ram..... | 683 |
| Water Softeners, Commercial..... | 504-512 |
| Water Softeners, Hot Water..... | 542 |
| Water Softeners, Residential..... | 495 |
| Water Treatment Chemicals..... | 560-562 |
| Water Wizzard..... | 377 |
| Watertight Manhole..... | 449 |
| Watson McDaniel..... | 325-329 |
| Watts Air..... | 623-624 |
| Watts Pressure Regulators, Heating..... | 309 |
| Watts Relief Valves..... | 308 |
| Watts Water Regulating Valves..... | 355 |
| Wax Rings..... | 224 |
| WD-40..... | 729 |
| Weld Fittings, Steel..... | 78-79 |

| | | | |
|-------------------------------------|-------------------|------------------------|-----|
| Weldolet..... | 79 | Zurn Flush Valves..... | 202 |
| Welding Rod, PVC..... | 79,594 | Zurn Gaskets..... | 224 |
| Welding Vise, Ridgid..... | 663 | Zurn Hydrants..... | 7 |
| Well Caps..... | 428 | | |
| Well Casing..... | 432, 438, 450-451 | | |
| Wells, Immersion..... | 292, 316 | | |
| Well Points..... | 429 | | |
| Well Pro..... | 558 | | |
| Well Protectors..... | 449 | | |
| Well Pumps..... | 399-408, 410-415 | | |
| Well Sanitizer..... | 558 | | |
| Well Screen..... | 432, 438, 450-451 | | |
| Well Seal Elbow..... | 433 | | |
| Well Seals..... | 428 | | |
| Wellmate Tanks..... | 564 | | |
| Well Treatment..... | 558-559 | | |
| Well Xtrol Tanks..... | 435-436 | | |
| Wet Plug..... | 722 | | |
| Wheelchair Lavatory Strainer..... | 205 | | |
| Window Hardware Repair Kit..... | 263 | | |
| Wing Nut Test Plug..... | 688 | | |
| Winterguard..... | 338 | | |
| Wire Nuts..... | 417 | | |
| Wire Ties..... | 104 | | |
| Wire, Submersible Pump..... | 416-418 | | |
| Wisk Broom..... | 679 | | |
| Woods Couplings..... | 299 | | |
| Wrap On..... | 342 | | |
| Wrench, Adjustable..... | 648 | | |
| Wrench, Cartridge Filter..... | 480 | | |
| Wrench, Deep Socket..... | 684 | | |
| Wrench, Delta Faucet..... | 684 | | |
| Wrench, Element..... | 278 | | |
| Wrench, Fire Hydrant..... | 154 | | |
| Wrench, Internal Pipe..... | 700 | | |
| Wrench Parts, Ridgid..... | 667 | | |
| Wrench, Pipe..... | 661-662 | | |
| Wrench, Ridgid..... | 661-662 | | |
| Wrench, Spanner (Fire Hydrant)..... | 154 | | |
| Wrench, Super Sloan..... | 685 | | |
| Wrench, T&S Spanner..... | 166 | | |
| | -X- | | |
| X-Trol Tanks..... | 435-436 | | |
| Xpando..... | 725 | | |
| Xylene..... | 210 | | |
| | -Y- | | |
| Yarway Valves..... | 35 | | |
| Yeats Dolly Parts..... | 703 | | |
| | -Z- | | |
| Zeston Fittings..... | 341 | | |
| Zip-In Screws..... | 335, 689 | | |
| Zoeller Pumps..... | 387 | | |
| Zone Valves..... | 294 | | |
| Zone Valve Controllers..... | 291 | | |
| Zone Valves, Taco..... | 300 | | |

FILL OUT ORDER BLANK AND
FAX TO:
610-279-6299

WE WILL PROMPTLY RESPOND

MAKE SURE YOU COMPLETE THE
ENTIRE ORDER FORM
PLEASE BE SURE TO GIVE US
QUANTITY
DESCRIPTION
FIGURE NUMBER

DON'T FORGET YOUR NAME!

DUFF SUPPLY COMPANY

WATER TREATMENT EQUIPMENT - PUMPS - PLUMBING - HEATING - INDUSTRIAL SUPPLIES - PUMPS
STEAM SPECIALTIES - PIPE - VALVES - FITTINGS - SOFTENERS - FILTERS

201 EAST LAFAYETTE STREET, P.O. BOX 618, NORRISTOWN, PA 19401
PHONE: 610-275-4453 FAX: 610-279-6299

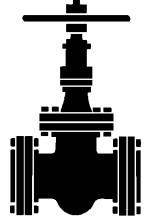

SOLD TO:

SHIP TO:

| | |
|--|--|
| | |
| | |
| | |

YOUR NAME: _____ PURCHASE ORDER NO. _____

TODAY'S DATE: _____ REQUIRED DATE: _____

| QTY | FIG. NO. | DESCRIPTION | PRICE/EA | TOTAL |
|-----|----------|-------------|----------|-------|
| | | | | |
| | | | | |
| | | | | |
| | | | | |
| | | | | |
| | | | | |
| | | | | |
| | | | | |
| | | | | |
| | | | | |
| | | | | |
| | | | | |
| | | | | |
| | | | | |



Products for Quality Water

TERMS: NET - 10TH OF MONTH FOLLOWING PURCHASE
WE WILL PREPAY AND ADD FREIGHT FOR ALL ORDERS SHIPPED UPS OR COMMON CARRIER

All accounts are to be paid in full to Duff Supply Company monthly by the tenth (10th) day of the month following invoice date, a 1% service charge and a 1% interest charge will be made on any balance open at the end of the month following invoice, and in the event that legal action or lien be undertaken, or the service of a collection agency are used to collect this account, the customer shall pay all expenses incurred by Duff Supply Company, such as, but not limited to, costs and collection, legal and lien fees.

_____/_____/_____
CONTACT / DATE
APPLICATION DATE

DUFF SUPPLY COMPANY, 201 E. LAFAYETTE ST., NORRISTOWN, PA 19401

PHONE: 610-275-4453

NEW ACCOUNT APPLICATION FORM

FAX APPLICATION TO: 610-275-6761

Date: _____

Business Name: _____

Billing Address: Street _____

City _____ State _____ Zip _____

Purchasing Phone _____ Accounts Payable Phone: _____ Fax Number: _____

Shipping Address: Street _____

(If Different) City _____ State _____ Zip _____

Phone (If Different) _____

Tax Exempt Number (Provide a copy of Certificate): _____

(WE CANNOT SET UP A TAX EXEMPT ACCOUNT WITHOUT A CERTIFICATE)

Principal's Name: _____ Principal's Phone: _____

Principal's Address: Street _____

City _____ State _____ Zip _____

Primary Contact Person: _____ Title _____

Type of Business: _____ Plbg. _____ Htg. _____ Pumps _____ Well Drilling _____ Hotel or Apartment _____ Municipality

_____ Factory (OEM) _____ Factory (Maintenance) _____ Office Building _____ Hospital _____ Shopping Center _____ Golf Course

_____ Water Treatment _____ Environmental _____ Other (describe) _____

Have you ever been contacted by one of our salesman? _____ Yes _____ No

What was his name? _____

Do you require Purchase orders? _____ Yes _____ No

Do you prefer Blanket Order? _____ Yes _____ No If yes, please outline your procedure: _____

Names of persons authorized to pick-up: _____

D & B Rating: _____

Check One: _____ Corporation _____ Partnership _____ Individual Proprietor

If division of another corporation, give parent company and relationship: _____

Credit Limit you are applying for: _____

Length of Time in Business: _____ Year Incorporated _____

Trade References:

Name _____ Type of Business _____

Address _____

City _____ State _____ Zip _____

Phone Number _____ Fax Number _____

Name _____ Type of Business _____

Address _____

City _____ State _____ Zip _____

Phone Number _____ Fax Number _____

Name _____ Type of Business _____

Address _____

City _____ State _____ Zip _____

Phone Number _____ Fax Number _____

Bank Reference: _____

Address of Branch _____

Officer who handles account: _____

PLEASE ATTACH FINANCIAL STATEMENT

Side 2 Must Be Completed

(Over)

We routinely fax invoices to our customers. Please provide the fax number where we can send your invoices: _____.

In consideration of your opening the above account and/or extending credit, the undersigned hereby agrees and certifies that all information supplied in this application is correct, that all accounts are to be paid in full to Duff Supply Company monthly by the tenth (10th) day of the month following invoice date, that a 1% service charge and a 1% interest charge will be made on any balance open at the end of the month following invoice date, and that in the event that legal action or lien be undertaken, or the services of a collection agency are used to collect this account, the undersigned shall pay all expenses incurred by Duff Supply Company, such as, but not limited to, collection fees, lien fees, costs, and legal fees.

Applicant (Name of Account)

By: _____

Title: _____

The Undersigned _____ and _____
for good and valuable consideration, hereby jointly, severally, and personally unconditionally guarantee, warrant and promise the full and prompt (within terms) payment of all bills and other obligations (as set forth above) of the applicant in connection with any credit extended to the applicant by Duff Supply Company. *

Principal

Witness

Principal's Spouse

Witness

Principal

Witness

Principal's Spouse

Witness

For Duff Supply Use Only:

Credit Limit: _____

Class: _____

Tax Jurisdiction: _____

Certificate Received: _____

Salesman: _____

Type: _____

Contact: _____

Controller: _____

General Manager: _____

Date Approved: _____

**As appropriate, we also may require the guarantee of a principal and, in some cases, the principal's spouse.*

**PLEASE FAX THIS FORM TO:
610-275-6761**

VISIT US!

We're easy to find!

FROM NORTH AND CENTRAL NJ VIA PA TURNPIKE

PA Turnpike West to Exit #25A, Midcounty Interchange
 Enter 476 South (Blue Route)
 Take first exit, Exit #7, Norristown
 Bear right onto Ridge Pike (which becomes Main Street)
 Go through 7 traffic lights (approximately 4 ³/₄ miles) and turn left onto Mill Street
 At stop sign turn right onto East Lafayette Street
 Turn right into parking lot!

FROM DE/MD

Take I-95 North to Route 476 North (Blue Route)
 Exit at Exit #7 - Norristown
 Bear right off Exit and go to first traffic light
 At traffic light, turn right onto Ridge Pike (which becomes Main Street) and go
 Through 8 traffic lights (approximately 5 miles) and turn left onto Mill Street
 At stop sign turn right onto East Lafayette Street
 Turn right into parking lot!

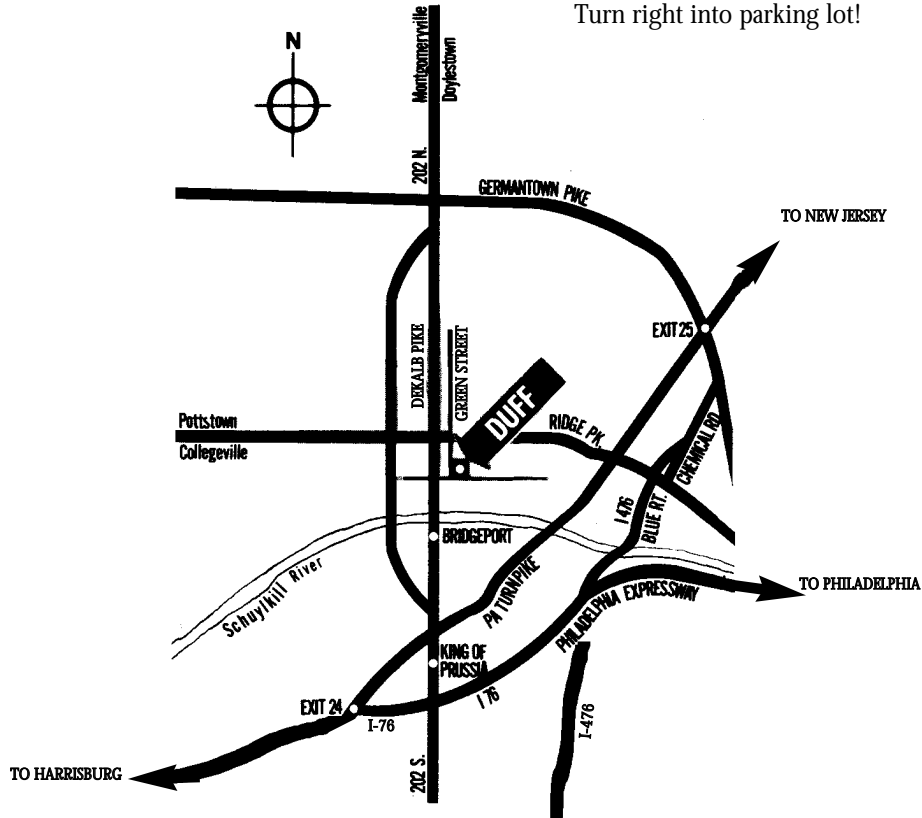

FROM SOUTH JERSEY VIA I-76

Take Route 76 West to Route 476 North (Blue Route)
 Exit at Exit #7 - Norristown
 Bear right off Exit and go to first traffic light
 At traffic light, turn right onto Ridge Pike (which becomes Main Street) and go
 Through 8 traffic lights (approximately 5 miles) and turn left onto Mill Street
 At stop sign turn right onto East Lafayette Street
 Turn right into parking lot!

FROM KING OF PRUSSIA

202 North to Main Street in Norristown
 Turn Right at light onto Main Street
 Pass Dekalb Street
 Turn right onto Mill Street
 At stop sign turn right onto East Lafayette Street
 Turn right into parking lot!

FROM WEST ON PA TURNPIKE OR ROUTE 422

PA Turnpike East To Exit #24, Valley Forge
 To Route 202 North (King of Prussia)
 202 North to Main Street in Norristown
 Turn right at light onto Main Street
 Pass Dekalb Street
 Turn right onto Mill Street
 At stop sign turn right onto East Lafayette Street
 Turn right into parking lot!
 -OR-
 Route 422 to 202 North
 202 North to Main Street in Norristown
 Turn Right at light onto Main Street
 Pass Dekalb Street
 Turn right onto Mill Street
 At stop sign turn right onto East Lafayette Street
 Turn right into parking lot!