

Tools

est. 1947

DUFF^{CO.}

When you need it now... or don't know how

PLUMBING & HEATING • PUMPS • WATER CONDITIONING
MULTIFAMILY HOUSING SUPPLIES

CATALOG

610.275.4453

duffcompany.com





LENOX METAL RECIPROCATING SAW BLADES

LENOX METAL RECIPROCATING SAW BLADES (5-PK)



Fig. No.	OEM No.	TPI	Length x Width x Thickness
194004	610GR	10	6 x 3/4 x .035 (Titanium coating)
60699	614R	14	6 x 3/4 x .035
193986	618R	18	6 x 3/4 x .035
193989	818R	18	8 x 3/4 x .035
60702	624R	24	6 X 3/4 X .035
202027	114GR	14	9 x 1 x .042 (Titanium coating)

LENOX WOOD & METAL RECIPROCATING SAW BLADES (5-PK)



Fig. No.	OEM No.	TPI	Length x Width x Thickness
60703	656R	6	6 X 3/4 X .050
193993	956R	6	9 X 3/4 X .050
193995	156R	6	12 X 3/4 X .050

LENOX GENERAL PURPOSE BI-METAL RECIPROCATING SAW BLADES (5-PK)



Fig. No.	OEM No.	TPI	Length x Width x Thickness
60705	810R	10	8 X 3/4 X .050
193998	650R	10/14	6 X 3/4 .050 (sold as 2-pack)
60704	110R	10/14	12 X 3/4 X .050

LENOX WOOD & METAL "RAPID PLUNGE" RECIPROCATING SAW BLADES (5-PK)



Fig. No.	OEM No.	TPI	Length x Width x Thickness
60703	656R	6	6 X 3/4 .050

LENOX CARBIDE GRIT RECIPROCATING SAW BLADES (2-PK)



Fig. No.	OEM No.	TPI	Length x Width x Thickness
60706	800RG	-	8 X 3/4 X .040

INQUIRE ABOUT THESE AND OTHER LENOX SAW BLADES AND KITS...



15-PIECE KIT WITH STORAGE CASE

Includes 5 each:	OEM No. 1073415RKG
614R	
618R	
656R	

5-PIECE BLADE ASSORTMENT WITH VINYL POUCH



Includes 1 each:	TPI	Length x Width x Thickness
414R	14	4 x 3/4 x .035
418R	18	4 x 3/4 x .035
614R	14	6 x 3/4 x .035
618R	18	6 x 3/4 x .035
656R	6	6 x 3/4 x .050



LENOX BI-METAL JIG SAW BLADES

7-PIECE T-SHANK BI-METAL JIGSAW BLADE SET WITH VINYL POUCH



T-SHANK



UNIVERSAL SHANK



7-PIECE U-SHANK BI-METAL JIGSAW BLADE SET WITH VINYL POUCH

Includes 1 each:	TPI	Length	OEM No. 20868U743SA
456S	6	4"	
450SR	10 (Down cut)	4"	
450S	10	4"	
406S	6	4"	
324S	24	3-5/8"	
318S	18	3-5/8"	
314S	14	3-5/8"	

Includes 1 each:	TPI	Length	OEM No. 20606U743JA
456J	6	4"	
450JR	10 (Down cut)	4"	
450J	10	4"	
406J	6	4"	
324J	24	3-5/8"	
318J	18	3-5/8"	
314J	14	3-5/8"	

ALL BLADES AVAILABLE AS 2-PACKS, 5-PACKS & 25-PACKS . . . CALL YOUR DUFF REP TODAY!

HACKSAWS

TRI-FOLD SAW FOLDING JAB



Fig. No.	Description
48994	Folding jab saw with blade
148216J6R	Replacement blade only

COMPACT HACKSAW



Fig No.
164142

HT50 HIGH-TENSION HACKSAW



Store up to 5 extra 12" hacksaw blades in its I-beam. Accepts any reciprocating saw blade to use as a jab saw.

Fig
48995

PLASTIC PIPE SAW



Fig	Description
48993	12" blade & handle
38148	18" blade & handle
48996	12" blade only
38149	18" blade only

PORTABAND BLADE



Fig	Description
255753	14 TPI
255754	18 TPI
255755	24 TPI

CLOSE QUARTER SAW



Fig	Description
194131	Saw with blade
194130	Replacement blades only

REPLACEMENT HACKSAW BLADES



TPI	LENGTH X WIDTH	1-PACK PROD NO	2-PACK PROD NO	10-PACK PROD NO	100-PACK PROD NO	APPLICATION
14	12 x 1/2	—	—	20143V214HE	—	Wood & Metal
18	10 x 1/2	20150S018HE	20163T018HE	20140V018HE	20110018HE	Heavy Metal
18	12 x 1/2	20154S218HE	20160T218HE	20144V218HE	20116218HE	Heavy Metal
24	10 x 1/2	20151S024HE	23930T024HE	20141V024HE	20111024HE	Medium Metal
24	12 x 1/2	20155S224HE	20161T224HE	20145V224HE	20117224HE	Medium Metal
32	10 x 1/2	20152S032HE	20164T032HE	20142V032HE	20112032HE	Thin Metal
32	12 x 1/2	20156S232HE	20162T232HE	20146V232HE	20118232HE	Thin Metal

HOLE SAWS

LENOX BI-METAL SPEED SLOT HOLE SAWS

Lenox offers a complete range of hole saw sizes and types for superior performance in all materials and applications. Speed Slot feature features a staircase design for easy plug removal.

DIAM-ETER	1 PER BOX	PIPE TAP	USE ARBOR	
			SNAP-BACK	STANDARD
IN	PROD NO	IN		
9/16	300099L	—	5L	1L, 4L or 5L
5/8	3001010L	—	5L	1L, 4L or 5L
11/16	3001111L	—	5L	1L, 4L or 5L
3/4	3001212L	1/2	5L	1L, 4L or 5L
25/32	3009820MMHS		5L	1L, 4L or 5L
13/16	3001313L	—	5L	1L, 4L or 5L
7/8	3001414L	3/4	5L	1L, 4L or 5L
15/16	3001515L	—	5L	1L, 4L or 5L
1	3001616L	—	5L	1L, 4L or 5L
1-1/16	3001717L	—	5L	1L, 4L or 5L
1-1/8	3001818L	1	5L	1L, 4L or 5L
1-3/16	3001919L	—	5L	1L, 4L or 5L
1-1/4	3002020L	—	2L, 6L	2L, 3L or 6L
1-5/16	3002121L	—	2L, 6L	2L, 3L or 6L
1-3/8	3002222L	—	2L, 6L	2L, 3L or 6L
1-7/16	3002323L	—	2L, 6L	2L, 3L or 6L
1-1/2	3002424L	1-1/4	2L, 6L	2L, 3L, 6L or 7L
1-9/16	3002525L	—	2L, 6L	2L, 3L, 6L or 7L
1-5/8	3002626L	—	2L, 6L	2L, 3L, 6L or 7L
1-11/16	3002727L	—	2L, 6L	2L, 3L, 6L or 7L
1-3/4	3002828L	1-1/2	2L, 6L	2L, 3L, 6L or 7L
1-13/16	3002929L	—	2L, 6L	2L, 3L, 6L or 7L
1-7/8	3003030L	—	2L, 6L	2L, 3L, 6L or 7L
2	3003232L	—	2L, 6L	2L, 3L, 6L or 7L
2-1/16	3003333L	—	2L, 6L	2L, 3L, 6L or 7L
2-1/8	3003434L	—	2L, 6L	2L, 3L, 6L or 7L



DIAM-ETER	1 PER BOX	PIPE TAP	USE ARBOR	
			SNAP-BACK	STANDARD
IN	PROD NO	IN		
2-1/4	3003636L	2	2L, 6L	2L, 3L, 6L or 7L
2-3/8	3003838L	—	2L, 6L	2L, 3L, 6L or 7L
2-1/2	3004040L	—	2L, 6L	2L, 3L, 6L or 7L
2-9/16	3004141L	—	2L, 6L	2L, 3L, 6L or 7L
2-5/8	3004242L	2-1/2	2L, 6L	2L, 3L, 6L or 7L
2-11/16	3004343L	—	2L, 6L	2L, 3L, 6L or 7L
2-3/4	3004444L	—	2L, 6L	2L, 3L, 6L or 7L
2-7/8	3004646L	—	2L, 6L	2L, 3L, 6L or 7L
3	3004848L	—	2L, 6L	2L, 3L, 6L or 7L
3-1/8	3005050L	—	2L, 6L	2L, 3L, 6L or 7L
3-1/4	3005252L	3	2L, 6L	2L, 3L, 6L or 7L
3-3/8	3005454L	—	2L, 6L	2L, 3L, 6L or 7L
3-1/2	3005656L	—	2L, 6L	2L, 3L, 6L or 7L
3/5/8	3005858L	—	2L, 6L	2L, 3L, 6L or 7L
3-3/4	3006060L	3-1/2	2L, 6L	2L, 3L, 6L or 7L
3-7/8	3006262L	—	2L, 6L	2L, 3L, 6L or 7L
4	3006464L	—	2L, 6L	2L, 3L, 6L or 7L
4-1/8	3006666L	—	2L, 6L	2L, 3L, 6L or 7L
4-1/4	3006868L	4	2L, 6L	2L, 3L, 6L or 7L
4-3/8	3007070L	—	2L, 6L	2L, 3L, 6L or 7L
4-1/2	3007272L	—	2L, 6L	2L, 3L, 6L or 7L
4-5/8	3007474L	—	2L, 6L	2L, 3L, 6L or 7L
4-3/4	3007676L	4-1/2	2L, 6L	2L, 3L, 6L or 7L
5	3008080L	—	2L, 6L	2L, 3L, 6L or 7L
5-1/2	3008888L	—	2L, 6L	2L, 3L, 6L or 7L
6	3009696L	—	2L, 6L	2L, 3L, 6L or 7L

STANDARD HOLE SAW ARBORS



1 PER PACK PROD NO	DESC	FITS HOLE SAWS	SIZES	SHANK TYPE	SHANK SIZE	PRIMARY FEATURE
			IN		IN	
1779774	1L	9L-19L	9/16-1-3/16	Hollow Hex	1/2 & larger	Adjustable pilot bit
1779801	2L	20L-96L	1-1/4-6	Solid Hex	1/2 & larger	Use for enlarging holes
1856058	2L	20L-96L	1-1/4-6	Hollow Hex	1/2 & larger	Use for enlarging holes, adjustable pilot bit
1779802	3L	20L-96L	1-1/4-6	Solid/Hex	1/2 & larger	Solid shank
1779803	4L	9L-19L	9/16-1-3/16	3 sided	1/4 & larger	Adjustable pilot bit, 3 flats on shank
1779804	5L	9L-19L	9/16-1-3/16	Hex	3/8 & larger	Use for 9A-19A arbored hole saws
1779805	6L	20L-96L	1-1/4-6	Hex	3/8 & larger	Quick change arbor
1779806	7L	24L-96L	1-1/2-6	Hex	3/8 & larger	Plug ejection feature



HOLE SAW KITS

Plumber's Speed Slot Hole Saw Kit (10-piece)

Includes six hole saws (sizes 3/4", 7/8", 1-1/8", 1-3/8", 2", 2-1/2"), snap-back arbors (2L, 6L), pilot drill, arbor adapter



Fig. No.
61429

Plumber's Speed Slot Hole Saw Kit (17-piece)

Includes 12 hole saws (sizes 3/4", 7/8", 1-1/8", 1-1/2", 1-3/4", 2-1/4", 2-9/16", 3", 3-1/2", 4", 4-1/4", 4-1/2"), snap-back arbors (2L, 5L), three pilot drills



Fig. No.
250831

Lenox Vari-Bit Step Drill Bits

Enhanced two-flute design cuts fast, clean, round holes. Drill perfectly round holes in steel, brass, copper, aluminum, wood, plexiglass and plastic.



Fig. No.	Hole Sizes
43363	1/8, 5/32, 3/16, 7/32, 1/4, 9/32, 5/16, 11/32, 3/8, 13/32, 7/16, 15/32, 1/2"
43365	1/2, 9/16, 5/8, 11/16, 3/4, 13/16, 7/8, 15/16, 1"
43364	1/4, 5/16, 3/8, 7/16, 1/2, 9/16, 5/8, 11/16, 3/4"



All three step drill bits in kit with case
OEM No. 30889889

BORING AND DRILL BITS

Flat Boring Bits and Extensions

Flat boring bits are precision made of high carbon steel for durability and long life. Bore clean holes fast at any angle in wood, plastic, plywood and Formica®. Drill point and cutting edge can be resharpened often.

- Flute bit clears chips
- Bores cleaner and faster
- Fits Secure Chuck Grip
- Premium Quality — Heat treated for strength and hardness



Diameter	Shank Dia.	Length	Fig No.
1/4"	1/4"	6"	30532
5/16"	1/4"	6"	30533
3/8"	1/4"	6"	30534
7/16"	1/4"	6"	30535
1/2"	1/4"	6"	30536
9/16"	1/4"	6"	30541
5/8"	1/4"	6"	30542
11/16"	1/4"	6"	30543
3/4"	1/4"	6"	30544
13/16"	1/4"	6"	30545
7/8"	1/4"	6"	28930
15/16"	1/4"	6"	30547
1"	1/4"	6"	29160
1-1/8"	1/4"	6"	30548
1-1/4"	1/4"	6"	30549
1-3/8"	1/4"	6"	30550
1-1/2"	1/4"	6"	30551

Spade Bit Pro Set

8-piece set with case includes 3/8", 1/2", 5/8", 7/8", 1", 1-1/8", 1-1/2" bits



OEM No.
341008

DRILL ACCESSORIES



Self-Feed Bits

All sizes have removable and replaceable feed screws. Two feed screws furnished with each bit. Regular and coarse screws permit selecting the right feed for the material you're drilling. Coarse feed screws provides fast, effortless feeding, even in gummy woods.

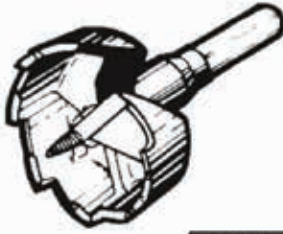

OEM #	Diameter	For Std Pipe Size	Fig No
1787512	1-1/8"	3/4"	16662
1787513	1-1/4"	—	16672
1787515	1-3/8"	—	16676
1787561	1-1/2"	1"	16680
1787562	1-3/4"	1"	16684
1787563	2"	1-1/2"	16689
1787564	2-1/8"	—	260273
1787565	2-1/4"	—	260274
1787566	2-9/16"	2"	2609276

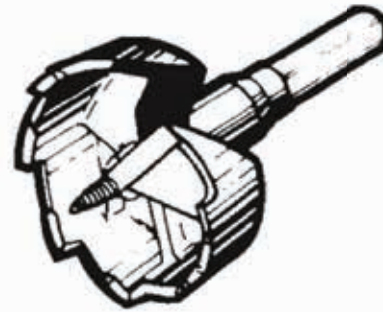

Large Self-Feed Bits

3", 3-5/8" and 4-5/8" sizes have double inside cutter blades that shave hole radius for clean smooth holes without pressure. Two feed screws furnished with each bit. All bits furnished with 3 milled flat type shank.

OEM #	Diameter	For Std Pipe Size	Fig No
1787502	3"	2-1/2"	16710
1787503	3-5/8"	3"	16715
1787504	4-5/8"	4"	—

est. 1947

DUFF CO.

When you need it now... or don't know how



12 Piece LENOX Bi-metal Self-feed Bit Kit includes:

- 1-3/8", 1-1/2", 2-1/8, 2-9/16"
- 5-1/2" Extension
- Five lead screws
- Slim tape file
- Hex Wrench Set

OEM No.
1787505



16 Piece LENOX Bi-metal Self-feed Bit Kit includes:

- 1-1/8", 1-1/2", 1-3/4", 2-1/8", 2-9/16" 1-1/4", 1-3/8", 1-1/2", 1-3/4", 2-1/8, 2-9/16"
- 5-1/2" Extension
- Five lead screws
- Hex Wrench Set



LENOX S1 PLASTIC TUBING CUTTERS



CUTS UP TO 1" NOMINAL
(1-5/16" MAX. OD)

PROD NO	DESCRIPTION
12121S1	PEX Cutter
12125S1B	Plastic Tubing Cutter Replacement Blade



TIGHT SPACES TUBING CUTTERS



OEM No.	Description	Tubing Diam.
14830TS12	Copper Cutting	1/2
14831TS34	Copper Cutting	3/4
14832TS1	Copper Cutting	1
14833TSK	3 pc Kits	1/2, 3/4, 1

CUTTERS

Fig. No.	OEM No.	Cutter	Tubing Diam.
--	1008TC58	Copper Cutting	1/8-5/8
228269	21009TC1	Copper Cutting	1/8-1
194106	21010TC118	Copper Cutting	1/8-1-1/8
194107	21011TC138	Copper Cutting	1/8-1-3/8
194108	21012TC134	Copper Cutting	1/8-1-3/4
194109	21013TC258	Copper/Plastic Cutting	1/4-2-5/8

Fig. No.	OEM No.	Replacement Wheels (6-pack)
194111	21015TCW158SS	Stainless Steel Cutting Wheels*
194112	21016TCW158P	Plastic Cutting Wheels ***
194113	21017TCW158C	Copper Cutting Wheels*
		*Fits LENOX Prod. No. 21010TC118, 21011TC138, 21012TC134, 21013C258 *** Fits LENOX Prod. No. 21013C258



PIPE WRENCHES

			SIZE	PIPE CAPACITY	RIDGID COMPETITIVE CROSS REFERENCE
	Fig. No.	PRODUCT NO	IN	IN	MODEL NO
Cast Aluminum	194100	2382010ALPW	10	1/1/02	810
	194101	2382112ALPW	12	2	812
	194102	2382214ALPW	14	2	814
	194103	2382318ALPW	18	2/1/02	818
	194104	2382424ALPW	24	3	824
	--	2382536ALPW	36	5	836
	--	2382648ALPW	48	6	848
Heavy-Duty Cast Iron	194094	2381208HDPW	8	1	8
	194096	2381310HDPW	10	1/1/02	10
	194097	2381412HDPW	12	2	12
	--	2381514HDPW	14	2	14
	194098	2381618HDPW	18	2/1/02	18
	194099	2381724HDPW	24	3	24
	--	2381836HDPW	36	5	36
	--	2381948HDPW	48	6	48





PLIERS

CURVED (V) JAW LARGE CAPACITY LOCKING PLIERS



Fig. No.	OEM No.	Description
260199	11T	Fast Release - 10"
260204	13T	Fast Release - 7"

CURVED ("V") JAW GROOVELOCK PLIERS
PRESS-N-SLIDE BUTTON ADJUSTS JAWS



Fig. No.	OEM No.	Description
260205	4935351	6"
260209	2078108	8"
260213	2078110	10"
260221	2078112	12"

STRAIGHT JAW GROOVELOCK PLIERS
PRESS-N-SLIDE BUTTON ADJUSTS JAWS



Fig. No.	OEM No.	Description
260207	4935095	8"
260211	4935096	10"
260219	4935098	12"
260221	2078112	12"

SMOOTH JAW GROOVELOCK PLIERS
PRESS-N-SLIDE BUTTON ADJUSTS JAWS



Fig. No.	OEM No.	Description
260217	4935097	10"
—	4935099	12"

CURVED ("V") JAW TRADITIONAL GROOVE JOINT PLIERS



Fig. No.	OEM No.	Description
—	2078508	8"
—	2078510	10"
—	2078512	12"

STRAIGHT JAW TRADITIONAL GROOVE JOINT PLIERS



Fig. No.	OEM No.	Description
—	2078508	8"
—	2078510	10"
—	2078512	12"

SLIP JOINT PLIERS



Fig. No.	OEM No.	Description
—	2078406	6"
—	2078408	8"
—	1773637	10"

LONG NOSE PLIERS



Fig. No.	OEM No.	Description
—	2078216	6" with wire cutter only (pictured)
260223	1773624	8" with wire stripper/cutter
—	1773637	10"

DIAGONAL CUTTING (DIKE) PLIERS



Fig. No.	OEM No.	Description
—	2078306	6"
—	2078307	7"
—	2078308	8"

8-PIECE PLIERS AND WRENCH KIT BAG SET



Fig. No.	OEM No.
—	2078712

ADJUSTABLE WRENCH



Fig. No.	OEM No.	Description
260237	2078606	6"
260238	2078608	8"
260239	2078610	10"
260240	2078612	12"

DUFFNOVE:

Check out pages 768-769 for all our Ridgid, ChannelLock & Knipex pliers



LEVELS



1550 SERIES MAGNETIC HEAVY DUTY I-BEAM LEVEL

Fig. No.	OEM No.	Description
--	1794106	24"
--	1794108	48"
--	1794110	78"
--	1794152	96"

250 SERIES MAGNETIC TORPEDO LEVEL



Fig. No.	OEM No.	Description
--	1794153	9"

ABS LINE LEVEL

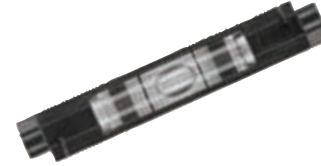

Fig. No.	OEM No.	Description
--	1794483	9"

SPEED-LINE REEL & BLUE CHALK COMBO



Fig. No.	OEM No.
--	64494

HEAVY-DUTY JOBSITE WORK GLOVES



Fig. No.	OEM No.	Description
260284	432001	Large
260285	432002	XL

GUM RUBBER KNEE PADS
SKID-RESISTANT, WON'T MAR OR SCRATCH FLOORS



Fig. No.	OEM No.
--	4033005

12" CONTRACTOR'S BAG



Fig. No.	OEM No.
260287	4402019

PRO BUCKET TOOL ORGANIZER



56 POCKETS,
FITS ON
5-GALLON
BUCKET

Fig. No.	OEM No.
--	420001

PIPE CLAMP

BUY ANY LENGTH NIPPLE TO SUIT YOUR NEEDS!



Fig. No.	OEM No.	Description
--	224134	3/4" IPS, 2" throat depth



QUICK-GRIP C-CLAMP

Fig. No.	OEM No.	Description
--	225103	3"
--	225104	4"
--	225105	5"
--	225106	6"
--	225108	8"



BAND CLAMP

Fig. No.	OEM No.
--	226100

RIDGID

RP 200-B CORDLESS COMPACT PRESS TOOL



PRESS TOOLS

- For pipe size 1/2" to 1-1/4"
- 18v
- Ram force 5400 lb.
- 5-second crimp time
- Includes (2) 20 Ah Li-Ion batteries, charger, carrying case
- 270 degree barrel/jaws swivel

OEM No.	Description
43428	RP 200 Battery Press Tool Kit w/ ProPress jaws (1/2", 3/4", 1" & 1-1/4")
43433	RP 200 Battery Press Tool Kit w/ProPress Jaws (1/2", 3/4" and 1")
43438	RP 200 Battery Press Tool Kit w/PureFlow PEX Jaws (1/2", 3/4", 1")

RP 210-B CORDLESS PRESS TOOL



- For pipe size 1/2" to 1-1/4"
- For PEX sizes 3/8" to 1-1/2"
- 18v
- Ram force 5400 lb.
- 5-second crimp time
- Includes (2) 20 Ah Li-Ion batteries, charger, carrying case
- 270 degree barrel/jaws swivel

OEM No.	Description
31028	RP 210 Battery Press Tool Kit w/ProPress Jaws (1/2", 3/4", 1" and 1-1/4")
31038	RP 210 Battery Press Tool Kit w/PureFlow PEX Jaws (1/2", 3/4" and 1")
43438	RP 200 Battery Press Tool Kit w/PureFlow PEX Jaws (1/2", 3/4", 1")

RP 340 CORDLESS PRESS TOOL (Corded Power Adapter Avail.)

- For pipe size 1/2" to 4"
- 18v
- Ram force 7200 lb.
- 5-second crimp time
- Includes (2) 20 Ah Li-Ion batteries, charger, carrying case
- 270 degree barrel/jaws swivel



OEM No.	Description
43348	RP 340 Battery Press Tool Kit w/ProPress Jaws (1/2", 3/4" and 1")
43358	RP 340 Battery Press Tool Kit w/ProPress Jaws (1/2", 3/4", 1", 1-1/4", 1-1/2" and 2")
43368	RP 340 Corded Press Tool Kit w/ProPress Jaws (1/2", 3/4" and 1")
43373	RP 340 Corded Press Tool Kit w/ProPress Jaws (1/2", 3/4", 1", 1-1/4", 1-1/2" and 2")

STANDARD SERIES PROPRESS XLC RINGS FOR RP 340 PRESS TOOL



OEM No.	Description
20483	XL-C/S 2 1/2" to 4" Rings, Actuator and Case Complete
20543	XL-C/S 2 1/2" Press Ring
20548	XL-C/S 3" Press Ring
20553	XL-C/S 4" Press Ring
21878	V2 V2 Press Ring Actuator For Standard Ridgid Tools

MEGAPRESS SERIES RINGS FOR RP 340 PRESS TOOL



OEM No.	Description
48553	1/2", 3/4", 1", 1-1/4", 1-1/2" and 2" MegaPress Kit For Standard Ridgid Press Tools
48558	1/2", 3/4" and 1" MegaPress Kit For Standard Ridgid Press tools
43368	RP 340 Corded Press Tool Kit w/ProPress Jaws (1/2", 3/4" and 1")
43373	RP 340 Corded Press Tool Kit w/ProPress Jaws (1/2", 3/4", 1", 1-1/4", 1-1/2" and 2")

TIGHT SPACE PROPRESS RING KIT

Permit access in tighter spaces. Swivel actuator allows press tool to be placed +/-90 degrees to the tube being pressed!



OEM No.	Description
27423	V1 Kit, 1/2", 3/4", 1" and 1-1/4" Ring for 300 series equipment
27428	V2 Kit, 1-1/2" and 2" Ring for 300 series equipment
28043	C1 Kit, 1/2", 3/4", 1", 1-1/4" Ring for 200 series equipment
43373	RP 340 Corded Press Tool Kit w/ProPress Jaws (1/2", 3/4", 1", 1-1/4", 1-1/2" and 2")

PRESS SNAP SOIL PIPE CUTTER FOR RP 340



Provides fast and easy way to cut cast iron soil pipe, by connecting the cutter to a Ridgid press tool, wrapping the chain around the pipe, and pressing

OEM No.
34403

DUFF TIP:
See page 98C for Press Fittings

PEX & SHARKBITE TOOLS

COMPACT ANGLE CRIMP TOOL



Fig. No.	Size
210005	3/8"
210004	1/2"
--	3/4"

STRAIGHT CRIMP TOOL



Fig. No.	Size
172831	3/8"
130015	1/2"
130016	3/4"
172830	1"
172834	Combo 1/2" & 3/4"

RING CRUSHER



Fig. No.
199179

Makes fast work of removing crimp rings (on 1/2", 3/4" and 1") and PEX tube from fittings, this tool cuts through crimp rings and removes tubing.

MANABLOC MANIFOLD WRENCH



Allows you to easily tighten the lock-in nuts for a Manabloc with precision. For use with compression Manablocs only.

Fig. No.
172739

SHARKBITE QUICK RELEASE REMOVAL TOOL



Fast and easy removal of all brand push-fit plastic disconnect fittings, this tool works on copper, PEX & CPVC, for 3/8", 1/2" and 3/4" sizes.

Fig. No.
271475

SHARKBITE QUICK DISCONNECT TOOL



Fig. No.	Size
--	1/4"
--	3/8"
171072	1/2"
--	5/8"
171073	3/4"
184634	1"

SHARKBITE DEBURRING & GAUGE TOOL



For pipe deburring and depth setting of CPVC, PEX, and copper

Fig. No.
212787

SHARKBITE CONTRACTOR TOOL KIT



Fig. No.
223473

Kit Includes 2 each:

- 1/2" x 1/2" Straight Coupling (U008LF)
- 3/4" x 3/4" Straight Coupling (U016LF)
- 3/4" x 1/2" Reducing Coupling (U058LF)
- 1/2" x 1/2" Female Straight Connector (U072LF)
- 3/4" x 3/4" Female Straight Connector (U088LF)
- 1/2" x 1/2" Male Straight Connector (U120LF)
- 3/4" x 3/4" Male Straight Connector (U134LF)
- 1/2" x 1/2" Elbow (U248LF)
- 3/4" x 3/4" Elbow (U256LF)

Includes 1 each:

- 1/2" x 1/2" x 1/2" Tee (U362LF)
- 3/4" x 3/4" x 3/4" Tee (U370LF)
- 1/2" End Stop (U514LF)
- 3/4" End Stop (U518LF)
- 1/2" Disconnect Clip (U710LF)
- 3/4" Disconnect Clip (U712LF)
- 1/2" Disconnect Tongs (L711LF)
- 3/4" Disconnect Tongs (L713LF)
- Safe Seal Deburring Tool (U702LF)
- Carrying Case

SHARKBITE DISCONNECT TONGS



Fig. No.	Size
220621	1/2"
220622	3/4"
220623	1"

DUFFNOTE: SEE PAGE 98A & 98B FOR PEX FITTINGS AND TUBING AND SHARKBITE FITTINGS

MASONRY DRILLING



POWERS THROUGH REBAR

Compared to other masonry bits, IRWIN® SpeedHammer Power™ masonry bits are manufactured with twice the carbide in the tip for longer life when drilling in rebar-reinforced concrete. Manufactured with premium steel, these bits are optimized for cutting through concrete at high speeds. The flute has an outer groove that quickly removes dust and efficiently dissipates heat, increasing drilling speed and extending the overall life of the bit.

SPEEDHAMMER POWER FEATURES

1. Patented design has twice the carbide in the tip compared to other masonry bits, for two times longer life. It is optimized for cutting through rebar-reinforced concrete at high speeds.
2. Maximized flute with outer groove removes dust quickly and improves heat dissipation, increasing penetration speed and extending life of the bit.
3. Manufactured with premium steel for increased core strength, maximum durability, and extended bit life.
4. SDS® Plus shank is compatible with SDS Plus and TEC style drills.*

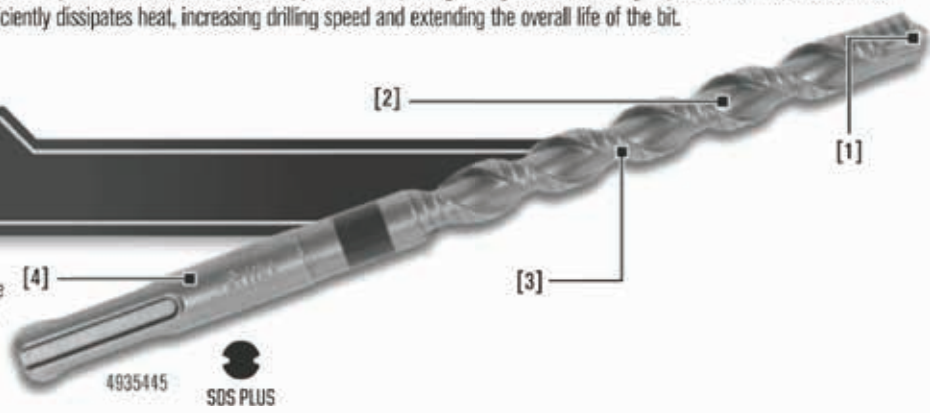

2X LONGER LIFE**

Description	Hang Tag Item #	Pack Qty	OEM #
SpeedHammer Power – 2-Cutter			
3/16" x 4" x 6"	4935448	1	4935461
3/16" x 6" x 8"	4935449	1	4935466
3/16" x 10" x 12"	4935447	1	–
1/4" x 4" x 6"	4935445	1	4935460
1/4" x 6" x 8"	4935446	1	4935465
1/4" x 10" x 12"	4935444	1	–
3/8" x 4" x 6"	4935454	1	4935463
3/8" x 6" x 8"	4935455	1	–
3/8" x 10" x 12"	4935453	1	–
1/2" x 4" x 6"	4935442	1	4935459
1/2" x 6" x 8"	4935443	1	–
1/2" x 10" x 12"	4935441	1	4935467
5/8" x 4" x 6"	4935457	1	4935464
5/8" x 6" x 8"	4935458	1	–
5/8" x 10" x 12"	4935456	1	4935470
3/4" x 4" x 6"	4935451	1	4935462
3/4" x 6" x 8"	4935452	1	–
3/4" x 10" x 12"	4935450	1	4935468
SpeedHammer Power Sets			
5-Pc. Set Contains: 3/16" x 6", 1/4" x 6" (2), 3/8" x 6", 1/2" x 6"	4935471	–	–
5-Pc. Set Contains: 3/16" x 6" (5)	1813617	–	–
5-Pc. Set Contains: 1/4" x 6" (5)	1813618	–	–

*R: SDS Plus is a registered trademark of Robert Bosch GmbH. ** vs. traditional masonry bits

MASONRY DRILLING

SpeedHammer Plus™ Metric



- Patented carbide tip design cuts fast and is self-centering for simple, controlled starts.
- Short drilling head forces debris into flute for faster penetration speed and extended bit life, and reduces breakout when drilling through-holes.

SDS-Max® Drill Bits



- Patented tip design enhances dust removal and provides symmetrical holes.
- Shot-peened, double-tempered finish for increased wear resistance and extended life.



MASONRY DRILLING

Description	OEM #
SpeedHammer Plus Metric - Tubed	
110 x 04.00 mm	IW13083
110 x 05.00 mm	IW13084
160 x 05.00 mm	IW13085
110 x 06.00 mm	IW13086
160 x 06.00 mm	IW13087
210 x 06.00 mm	IW13088
260 x 06.00 mm	IW13089
110 x 06.50 mm	IW13090
160 x 06.50 mm	IW13091
110 x 07.00 mm	IW13092
110 x 08.00 mm	IW13093
160 x 08.00 mm	IW13094
210 x 08.00 mm	IW13095
260 x 08.00 mm	IW13096
310 x 08.00 mm	IW13097
160 x 10.00 mm	IW13098
210 x 10.00 mm	IW13099
260 x 10.00 mm	IW13100
310 x 10.00 mm	IW13101
460 x 10.00 mm	IW13102
160 x 12.00 mm	IW13103
210 x 12.00 mm	IW13104
310 x 12.00 mm	IW13105
460 x 12.00 mm	IW13106
160 x 13.00 mm	IW13107
260 x 13.00 mm	IW13108
310 x 13.00 mm	IW13109
160 x 14.00 mm	IW13110
210 x 14.00 mm	IW13111
260 x 14.00 mm	IW13112
310 x 14.00 mm	IW13113
160 x 15.00 mm	IW13114
160 x 16.00 mm	IW13115
210 x 16.00 mm	IW13116
300 x 16.00 mm	IW13117
210 x 18.00 mm	IW13118
300 x 18.00 mm	IW13119
210 x 19.00 mm	IW13120
300 x 19.00 mm	IW13121
460 x 19.00 mm	IW13122
210 x 20.00 mm	IW13123
300 x 20.00 mm	IW13124
460 x 20.00 mm	IW13125
260 x 22.00 mm	IW13126
460 x 22.00 mm	IW13127
260 x 25.00 mm	IW13128
310 x 25.00 mm	IW13129
460 x 25.00 mm	IW13130

Description	OEM #
SDS-Max - 2-Cutter - Tubed	
3/8" x 7-1/2" x 13"	323000
1/2" x 7-1/2" x 13"	323001
1/2" x 15-1/2" x 21"	323002
9/16" x 7-1/2" x 13"	323003
9/16" x 15-1/2" x 21"	323004
SDS-Max - 4-Cutter - Tubed	
5/8" x 7-1/2" x 13"	323005
5/8" x 15-1/2" x 21"	323006
5/8" x 30-1/2" x 36"	323007
11/16" x 15-1/2" x 21"	323008
3/4" x 8" x 13"	323009
3/4" x 17" x 21"	323010
3/4" x 31" x 36"	323011
13/16" x 17" x 21"	323012
7/8" x 8" x 13"	323014
7/8" x 17" x 21"	323015
1" x 8" x 13"	323016
1" x 17" x 21"	323017
1" x 31" x 36"	323018
1-1/8" x 12" x 17"	323020
1-1/8" x 17" x 21"	323022
1-1/4" x 10" x 15"	323023ZR
1-1/4" x 18" x 23"	323024
1-1/4" x 31" x 36"	323025
1-3/8" x 18" x 23"	323028
1-1/2" x 18" x 23"	323031
1-3/4" x 17" x 23"	323033
2" x 17" x 23"	323034
Adapters	
Adapter, SDS-Max to SDS Plus	327001



MASONRY DRILLING



SPEEDHAMMER PLUS FEATURES

1. Patented carbide tip design cuts fast and is self-centering for simple, controlled starts.
2. Short drilling head forces debris into flute for faster penetration speed and extended bit life, and reduces breakout when drilling through-holes.
3. Unique flute design clears debris quickly, reducing clogging, minimizing vibration, and increasing overall drilling speed and bit life.
4. SDS⁺ Plus shank is compatible with SDS Plus and TEC style drills.*

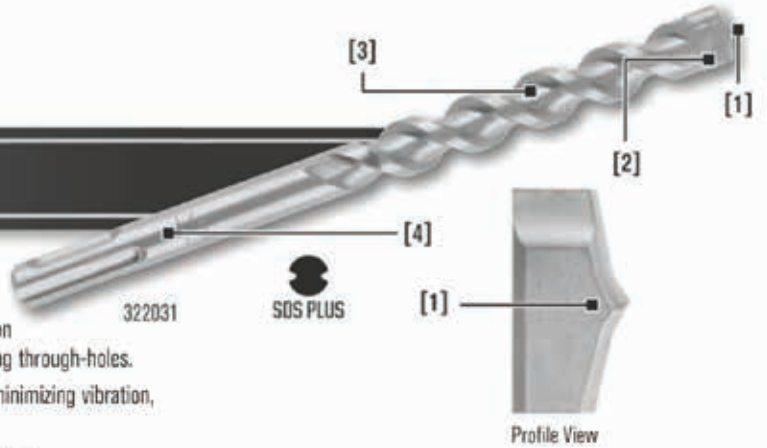

Description	OEM #
SpeedHammer Plus - 2-Cutter	
5/32" x 2" x 4"	322001
5/32" x 4" x 6"	322002
3/16" x 2" x 4"	322003
3/16" x 4" x 6"	322004
3/16" x 6" x 8"	322005
3/16" x 8" x 10"	322006
3/16" x 10" x 12"	322007
7/32" x 4" x 6"	322013
7/32" x 6" x 8"	322014
7/32" x 10" x 12"	322015
1/4" x 2" x 4"	322016
1/4" x 4" x 6"	322017
1/4" x 6" x 8"	322018
1/4" x 8" x 10"	322019
1/4" x 10" x 12"	322020
1/4" x 12" x 14"	322021
5/16" x 4" x 6"	322022
5/16" x 10" x 12"	322023
3/8" x 4" x 6"	322024
3/8" x 8" x 10"	322025
3/8" x 10" x 12"	322026
3/8" x 16" x 18"	322027
3/8" x 22" x 24"	322028
7/16" x 4" x 6"	322029
7/16" x 10" x 12"	322030
1/2" x 4" x 6"	322031
1/2" x 8" x 10"	322032
1/2" x 10" x 12"	322033
1/2" x 16" x 18"	322034
1/2" x 22" x 24"	322035
9/16" x 4" x 6"	322036
9/16" x 10" x 12"	322037
9/16" x 16" x 18"	322038
5/8" x 4" x 6"	322041
5/8" x 6" x 8"	322042
5/8" x 10" x 12"	322043
5/8" x 16" x 18"	322044
5/8" x 22" x 24"	322045
11/16" x 6" x 8"	322046
3/4" x 6" x 8"	322047
3/4" x 10" x 12"	322048
3/4" x 16" x 18"	322049



Description	OEM #
3/4" x 22" x 24"	322050
7/8" x 6" x 8"	322051
7/8" x 10" x 12"	322052
7/8" x 16" x 18"	322053
1 x 8 x 10	322054
1" x 16" x 18"	322055
SpeedHammer Plus - 4-Cutter	
3/4" x 16" x 18"	322082
7/8" x 16" x 18"	322085
1" x 16" x 18"	322087
1-1/8" x 16" x 18"	322089
SpeedHammer Plus - Hex Drive Drill Bits	
3/16" x 2" x 5"	322056
3/16" x 3" x 6"	322057
3/16" x 4" x 7"	322058
5/32" x 2" x 5"	322059
5/32" x 4" x 7"	322061
SpeedHammer Plus - 2-Cutter Sets	
5-Pc. Set Contains: 5/32" x 6", 3/16" x 6", 1/4" x 6", 3/8" x 6", and 1/2" x 6"	4935077
5-Pc. Set Contains: 5/32" x 6" (5)	1813552
5-Pc. Set Contains: 3/16" x 6" (5)	1813553
5-Pc. Set Contains: 1/4" x 6" (5)	1813554
5-Pc. Set Contains: 3/8" x 6" (5)	1813555
5-Pc. Set Contains: 1/2" x 6" (5)	1813616



2-cutter Head



4-cutter Head



*IR: SDS Plus is a registered trademark of Robert Bosch GmbH.

MASONRY DRILLING

Spline Drill Bits



324011

- Patented tip design enhances dust removal and provides symmetrical holes.
- Shot-peened, double-tempered finish for increased wear resistance and extended life.



2-cutter Head



4-cutter Head

Description	OEM #
Spline - 2-Cutter - Tubed	
3/8" x 5" x 10"	324000
3/8" x 8" x 13"	324001
3/8" x 11" x 16"	324002
1/2" x 5" x 10"	324003
1/2" x 8" x 13"	324004
1/2" x 11" x 16"	324005
1/2" x 17" x 22"	324006
1/2" x 24" x 29"	324007
1/2" x 31" x 36"	324008
9/16" x 8" x 13"	324009
9/16" x 17" x 23"	324010
5/8" x 5" x 10"	324011
5/8" x 11" x 16"	324012
5/8" x 17" x 22"	324013
5/8" x 31" x 36"	324015
3/4" x 5" x 10"	324017
3/4" x 8" x 13"	324018
3/4" x 11" x 16"	324019
3/4" x 17" x 22"	324020
3/4" x 24" x 29"	324021
3/4" x 31" x 36"	324022
7/8" x 11" x 16"	324025
7/8" x 17" x 22"	324026
7/8" x 31" x 36"	324027
1" x 8" x 13"	324028
1" x 11" x 16"	324029
1" x 17" x 22"	324030
1" x 31" x 36"	324031
1 1/8" x 11" x 16"	324033
1 1/8" x 17" x 22"	324034
1 1/4" x 11" x 16"	324035
1 1/4" x 17" x 22"	324036
1 1/4" x 31" x 36"	324037
1 3/8" x 11" x 16"	324038
1 3/8" x 17" x 22"	324039
1 1/2" x 11" x 16"	324040
1 1/2" x 17" x 22"	324041
1 3/4" x 17" x 22"	324043
2" x 17" x 22"	324044

Description	OEM #
Spline - 4-Cutter - Tubed	
5/8" x 5" x 10"	324050
5/8" x 11" x 16"	324051
5/8" x 17" x 22"	324052
5/8" x 24" x 29"	324053
5/8" x 31" x 36"	324054
11/16" x 11" x 16"	324055
3/4" x 11" x 16"	324056
3/4" x 5" x 10"	324057
3/4" x 17" x 22"	324058
3/4" x 24" x 29"	324059
3/4" x 31" x 36"	324060
7/8" x 11" x 16"	324063
7/8" x 17" x 22"	324064
1" x 11" x 16"	324065
1" x 17" x 22"	324066
1" x 31" x 36"	324067
1" x 24" x 29"	324068
1 1/8" x 11" x 16"	324070
1 1/8" x 17" x 22"	324071
1 1/4" x 11" x 16"	324072
1 1/4" x 17" x 22"	324073
1 1/4" x 31" x 36"	324074
1 3/8" x 17" x 22"	324076
1 1/2" x 17" x 22"	324078
1 3/4" x 18" x 23"	324080
2" x 18" x 23"	324081
Adapters	
Adapter, Spline to SDS Plus	327002



MASONRY DRILLING



One-Piece Hammer Core Spline



325000



Description	OEM #
Spline - One-Piece Hammer Cores - Tubed	
1-1/2" x 11-3/8"	325000
1-1/2" x 22"	325001
2" x 11-3/8"	325002
2" x 22"	325003
2-1/2" x 11-3/8"	325004
2-1/2" x 22"	325005
3-1/8" x 11-3/8"	325006
3-1/8" x 22"	325007
3-1/2" x 11-3/8"	325008
3-1/2" x 22"	325009
4" x 11-3/8"	325010
4" x 22"	325011
5" x 11-3/8"	325012
5" x 22"	325013

One-Piece Hammer Core SDS-Max[®]



325030



325031

Description	OEM #
SDS-Max - One-Piece Hammer Cores - Tubed	
1-1/2" x 11-3/8"	325014
1-1/2" x 22"	325015
2" x 11-3/8"	325016
2" x 22"	325017
2-1/2" x 11-3/8"	325018
2-1/2" x 22"	325019
3-1/8" x 11-3/8"	325020
3-1/8" x 22"	325021
3-1/2" x 11-3/8"	325022
3-1/2" x 22"	325023
4" x 11-3/8"	325024
4" x 22"	325025
5" x 22"	325026
6" x 22"	325027
Ejector Key	325030
Center Bit	325031

Masonry Installer Bits



40012

- Hole in flute makes it easy to pull wire through walls, ceilings, and floors.
- Specially designed flute quickly clears masonry dust.
- Heavy duty 118° point enters material quickly.
- Carbide tip cutting edge is ideal for use where masonry construction is encountered, including brick, mortar joints, and cinder blocks.

Diameter	Shank Size	Overall Length	OEM #
1/4"	.245"	18"	40004ZR
5/16"	.250"	18"	40005
3/8"	.370"	18"	40006
1/2"	.370"	18"	40008
5/8"	.370"	18"	40010
3/4"	.370"	18"	40012

MASONRY DRILLING

Flat Chisel



332003

- For general chiseling and breaking work in brick, concrete and loose stone (ex: when laying cables)

Slotting Chisel



332013

- For brick repair (ex: removing pointing)

Gouge



332016

- For cutting narrow channels into concrete

Scaling Chisel



332008

- For removing large quantities of material

Clay Spade



332014

- For general garden and landscaping (not for use in concrete)

Bush Tool



332017

- For roughing up concrete and asphalt prior to a surface treatment

Wide Scaling Chisel



332010

- For removing large areas of floor covering and reward sheeting

Pointed Spade



333014

- For digging in soil (not for use in concrete)

Ground Rod Driver



332019

- For driving in ground rods (ex: telecommunications)

Scraping Chisel (Angled)



332011

- For easy removal of tiles (with ergonomically angled working end)

Asphalt Cutter



332015

- For road repairing, road surfaces or other road maintenance (not for use in concrete)

Tamping Rod



332021

- For compacting soil and gravel

Mortar/Seam Tool



332012

- For the removal and cleaning of pointing in brick and mortar

Moil Point



331000

- For general chiseling and breaking work in brick, concrete and loose stone (ex: when laying cables)

Tamping Plate



332020

- For compacting soil and gravel

Description	OEM #
SDS-Max® - Demolition Chisel Hammer Bits - Bulk	
Moil Point - 12"	332000
Moil Point - 18"	332001
Flat Chisel - 1" x 12"	332003
Flat Chisel - 1" x 18"	332004
Scaling Chisel - 1-1/2" x 12"	332006
Scaling Chisel - 2" x 12"	332008
Wide Scaling Chisel, 3" x 12"	332010
Scraping Chisel - 2" x 12", Angled	332011
Mortar/Seam Tool - 1-1/8" x 12"	332012
Slotting Chisel - 1-3/8" x 12"	332013
Clay Spade - 4" x 16"	332014
Asphalt Cutter - 4-3/8" x 16"	332015
Gouge - 1" x 12"	332016
Bush Tool, 1-Pc - 1-3/4" x 9-1/2"	332017
Ground Rod Driver - 7/8"-1.35" x 10-1/4"	332019
5" x 5" Tamping Plate	332020
12" Tamping Rod SDS-Max® Shank	332021
SDS-Plus® - Demolition Chisel - Hang Tag	
Moil Point - 10"	331000
Flat Chisel - 3/4" x 10"	331001
Scaling Chisel - 1-5/8" x 10"	331002

Description	OEM #
Spline - Demolition Chisel Hammer Bits - Bulk	
Moil Point - 12"	333000
Moil Point - 18"	333001
Flat Chisel - 1" x 12"	333003
Flat Chisel - 1" x 18"	333004
Scaling Chisel - 1-1/2" x 12"	333006
Scaling Chisel - 2" x 12"	333008
Wide Scaling Chisel - 3" x 12"	333010
Scraping Chisel - 2" x 12", Angled	333011
Slotting Chisel - 1-3/8" x 12"	333012
Pointed Spade - 5-3/8" x 16"	333014
Asphalt Cutter - 4-3/8" x 16"	333015
Gouge - 1" x 12"	333016
Bush Tool, 1-Pc - 1-3/4" x 9-1/4"	333017
Ground Rod Driver - 7/8"-1.35" x 10-1/4"	333019
5" x 5" Tamping Plate	333020
12" Tamping Rod Spline Shank	333021

IRWIN[®]

TOOLS

DRILL BITS

Lock-n-Load Quick Change Extensions

- Carbon steel construction sleeve and body for durability and life
- Lock-n-Load® system for one-handed quick release
- Patented jaw design holds bits securely on 6-flatted shanks, as well as ball detent bits
- 1/4" Quick Change range now holds insert bits; magnetic for holding



Fig. No.	OEM No.	Description
260270	4935703	1/4" Quick Change Bit Holder - 2" OAL
260721	4935704	1/4" Quick Change Bit Holder - 6" OAL
260272	4935705	1/4" Quick Change Bit Holder - 12" OAL
260281	4935651	3/8" Quick Change Bit Holder - 2" OAL
260282	4935652	3/8" Quick Change Bit Holder - 5-1/2" OAL
260283	4935653	3/8" Quick Change Bit Holder - 12" OAL
260278	4935654	7/16" Quick Change Bit Holder - 5-1/2" OAL
260279	4935655	7/16" Quick Change Bit Holder - 12" OAL
260280	4935656	7/16" Quick Change Bit Holder - 18" OAL



Glass and Tile Masonry Drill Bits

- Carbide spear-point tip cuts clean, round holes with minimized chipping in glass, tile, and ceramic.



Fig. No.	OEM No.	Size
--	50508	1/8"
--	50512	3/16"
--	50516	1/4"
--	50520	5/16"
--	50524	3/8"
--	50532	1/2"

Masonry Bits

Multi-Material Jobber Length Bits

Drill through just about any type of material out there – brick, block, tile, metal, wood, plastic and marble – they'll even drill through multiple materials at the same time. Designed for rotary drilling, but tough enough to be used with hammer drills.



Fig. No.	OEM No.	Description	Hole Size	Overall Length	Flute Length
--	4935105	Multi-Material Drill Bit 1/8" x 3"	1/8"	3"	2"
--	4935106	Multi-Material Drill Bit 5/32" x 3-1/2"	5/32"	3-1/2"	2-1/2"
--	4935107	Multi-Material Drill Bit 3/16" x 3-3/4"	3/16"	3-3/4"	2-3/4"
--	1792767	Multi-Material Drill Bit 7/32" x 4"	7/32"	4"	3"
--	4935108	Multi-Material Drill Bit 1/4" x 4"	1/4"	4"	3"
--	1792768	Multi-Material Drill Bit 9/32" x 4"	9/32"	4"	3"
--	4935109	Multi-Material Drill Bit 5/16" x 4-3/4"	5/16"	4-3/4"	3-3/4"
--	1792769	Multi-Material Drill Bit 3/8" x 5"	3/8"	5"	4"
--	1792770	Multi-Material Drill Bit 7/16" x 5"	7/16"	5"	4"
--	1792771	Multi-Material Drill Bit 1/2" x 5"	1/2"	5"	4"

Multi-Material Extended Length Bits

Fig. No.	OEM No.	Description	Hole Size	Overall Length	Flute Length
--	1813898	1/4" x 16"	1/4"	16"	11-3/4"
--	1813899	5/16" x 16"	5/16"	16"	11-3/4"
--	1813900	3/8" x 16"	3/8"	16"	11-3/4"
--	1813901	7/16" x 16"	7/16"	16"	11-3/4"
--	1813902	1/2" x 16"	1/2"	16"	11-3/4"
--	1792768	9/32" x 4"	9/32"	4"	3"
--	4935109	5/16" x 4-3/4"	5/16"	4-3/4"	3-3/4"
--	1792769	3/8" x 5"	3/8"	5"	4"
--	1792770	7/16" x 5"	7/16"	5"	4"
--	1792771	1/2" x 5"	1/2"	5"	4"

TAPS AND DIES & DRILL



WATCHA-CALLIT KIT
29 Piece magnetic screwdriver set with bits

FIG. NO.	PRICE
44456	

HIGH SPEED TWIST DRILLS



DIA	OVER ALL LENGTH	LENGTH OF TWIST	FIG. NO.
1/16	2 5/8	7/8	15472
5/64	2 3/4	1	15473
3/32	2 7/8	1 1/4	15474
7/64	3 1/8	1 1/2	15475
1/8	3 1/4	1 5/8	15476
9/64	3 1/2	1 3/4	15477
5/32	3 5/8	2	15478
11/64	3 3/4	2 1/8	15479
3/16	3 7/8	2 5/16	15480
13/64	4	2 7/16	15481
7/32	4 1/8	2 1/2	15482
15/64	4 1/4	2 5/8	15483
1/4	4 3/8	2 3/4	15484
17/64	4 1/2	2 7/8	15485
9/32	4 5/8	2 15/16	15486
19/64	4 3/4	3 1/16	15487
5/6	4 7/8	3 3/16	15488
21/64	5	3 5/16	15489
11/32	5 1/8	3 7/16	15490
23/64	5 1/4	3 1/2	15491
3/8	5 3/8	3 5/8	15492
25/64	5 1/2	3 3/4	15493
13/32	5 5/8	3 7/8	15494
27/64	5 3/4	3 15/16	15496
7/16	5 7/8	4 1/16	15497
29/64	6	4 3/16	15498
15/32		4 15/16	15499
31/64		4 3/8	15500
1/2		4 1/2	15501



58 PIECE MASTER MECHANIC'S SET
(hexagon dies) in molded plastic case. 23 cuts, 23 taps, 17 one inch hexagon dies, 6 17/16 hexagon dies. See sizes and types of threads in table below. Also includes tap and reamer wrenches, 2 die stocks, T-handle tap wrench, 1 screw pitch gauge, 1 screwdriver, and Nos. 1-5 screw extractors.

SIZES AND THREADS PER INCH

NC	6-32	1/8-27	8-32	10-24	12-24	1/4-20	5/16-7/16	18
NF	14	1/4-28	5/6-24	3/8-24	7/16	20	7/2-20	
NPT	5/8-18	1/4-18						

FIG. NO.	PRICE
51060	



40 PIECE PROFESSIONAL MECHANIC'S SET
17 plug taps, 17 1" hexagon dies, 1 die stock, 1 tap wrench, 2 T-handle wrenches, 1 screw pitch gauge and 1 screwdriver.

SIZES AND THREADS PER INCH

NC	4-40	6-32	8-32	10-24	12-24	1/4-20	5/16	3/8-16
	7/16-4	1/2-13						
NF	10-32	1/4-28	5/16	3/8-24	7/16	1/2-20		
NPT	1/8-27	24	20					

FIG. NO.	PRICE
15515	

DUFF TIP:

HOW TO USE A TAP & DIE

Damaged bolts can be fixed using a tap and die set.

Properly functioning screws and bolts are integral to nearly any project. When they lose their teeth -- when they are stripped -- they will bind and otherwise not work. Sometimes, replacing a screw or bolt is not practical for financial or time reasons. When this is the case, a tap and die set is a key workshop item for getting the project back on track. The tap part of the set works with nuts, while the die is used to repair bolts.

WHAT YOU'LL NEED

- Tap and die set
- Vice
- Lubricant
- Compressed air

Use the gauge (included in most tap & die sets) to calculate threads per inch.

Select the corresponding die that matches with the reading on the thread per inch gauge, and set the die in the handle that comes with the set.

Secure the head of the damaged bolt or screw in a vice, and turn the die onto its damaged thread, adding lubricant periodically.

Blow the area with compressed air every few turns of the die to ensure the metal shavings don't clog the area.

Continue turning the die until you have moved along the screw or bolt's entire length smoothly.

Use the gauge to determine the thread count of the damaged nut. If you've already used a die on a corresponding bolt, the thread count will be the same.

Select the corresponding tap that matches with the reading on the gauge, and set it in the handle.

Place the nut in a vice, and begin turning the tap into it. Use oil periodically, and blow any metal shavings away with compressed air.

Thread the repaired nut onto the repaired bolt. They should fit correctly. If not, try the tap and die process again.

DUFF DELIVERS



CUTTERS

RATCH-CUT TUBE CUTTER



Fig.	Type
38932	RC1125 Close Cutter cuts quickly and precisely through copper, brass, stainless steel, aluminum and plastic tubing, with diameter from 5/16" to 1-1/8"
38934	Cutting wheels only

RIDGID 2-IN-1 AUTOFEED CUTTER WITH RATCHET HANDLE



Fig.	OEM No.
--	32573
See page 652 for other cutters	

GENERAL WIRE AUTOCUTTER



Fig.	Type
91579	1/2"
91580	3/4"
96870	Replacement cutting wheel

RIDGID POWERED PLASTIC CUTTER



Fig. No.	OEM No.	Description
--	36533	Complete Kit
--	36673	Replacement blade only

RIDGID PLASTIC INNER-OUTER REAMER



Fig.	Description
13600	For ID reaming and OD beveling 1/4" to 1-1/2" of thin-wall materials

RIDGID HD STEEL INNER-OUTER REAMER



For ID reaming and OD beveling of copper and stainless steel

Fig. No.	OEM No.	Description
--	29983	1/4" to 1-1/4"
--	29993	1/2" to 2"

RIDGID DEBURRING TOOLS FOR PLASTIC



Fig. No.	SIZE
13140	1/2" to 1-1/2"
83968	1-1/2" to 3"
83967	4"

DEBURRING TOOL



Fig. No.	71403
----------	-------

RIDGID TUBE BENDERS



Designed for bending annealed copper, steel and stainless with wall thickness less than or equal to .06" to a maximum of 180°

Fig.	Description
23167	1/4"
43740	3/8"
43741	1/2"



RIDGID ONE STOP WRENCH



- Two wrenches in one
- Provides exact size wrench to install angle stops and compression couplings

Fig. No.	OEM No.
--	27023

MISC. TOOLS

RIDGID FAUCET & SINK INSTALLER



- Notched ends engage 2, 3, 4, and 6 tab basin nuts
- Open slot allows easy access over existing supply lines
- Shut off valve attachment turns hard-to-reach angle stops without marring chrome



Fig. No.	OEM No.
79448	66807

HEAVY DUTY MEASURING TAPE 25'



Fig. No.
137819

PASCO PEDESTAL SINK WRENCH

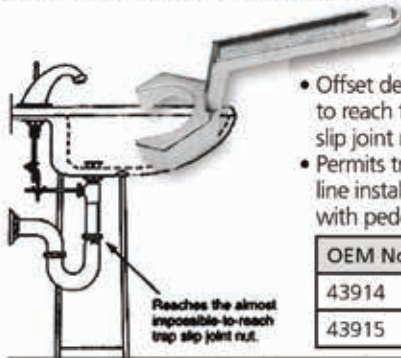

- Offset design allows user to reach tailpiece & trap slip joint nuts
- Permits trap and drain line installation or removal with pedestal sink in place

Reaches the almost impossible-to-reach trap slip joint nut.

OEM No.	Size
43914	1-1/4"
43915	1-1/2"



DISPOSABLE SHOE COVERS (40/BOX)



Fig. No.
305064

PASCO TOILET BOOT (12/BOX)

- Protects bathroom floors
- An absolute must for hassle-free toilet moving or removal



Fig. No.
1080

PASCO HAND PUMP

- Use to drain or transfer water
- 6-foot hose



Fig. No.
125071

PRO-STRAP

- Professional tie-down strap designed by mechanics for mechanics!
- Allows you to fasten light-weight pipe, ladders, poles & other job materials quickly & securely
- Strong, durable material - black woven polypropylene & industrial strength velcro



Fig. No.	Length
110550	43"

BASIN BUDDY BASIN NUT WRENCH



Cutaway fits around existing supply tube to remove coupling nut.

Once coupling nut is removed, cutaway fits around the faucet shank (1/2") to remove metal and plastic locknuts.

Unique slots in Basin Buddy socket grabs locknut "wings" without breaking.

- Includes ratchet adapter

Fig. No.
1890002

PASCO 4-IN-1 STRAINER WRENCH

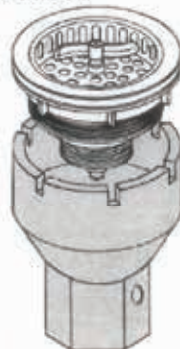

Fig. No.
4948

TOILET MASTER JACK



RIDGID TUBING CUTTERS

RIDGID

Midget Tubing Cutters

For up to 1/16" O.D. Tubing
In Extreme Close Quarters



These tubing cutters are specifically designed for use in extra close quarters on small size hard and soft copper, aluminum, brass and plastic tubing. Two rollers opposite cutter wheel permit easier rotation and faster cutting. Slide and wheel housing are strong and light weight. Large, knurled feed screw knob gives easy control of cutting pressure for clean cuts.

OD CAPACITY	TURNING RADIUS	OEM #	FIG. NO.	PRICE
1/4" - 1 1/8"	2 1/16"	40617	43533	
1/8" - 5/8"	1 5/16" max	32975	13578	
1/8" - 15/16"	1 11/16" max	32985	13579	

RIDGID Quick-Acting Tubing Cutters

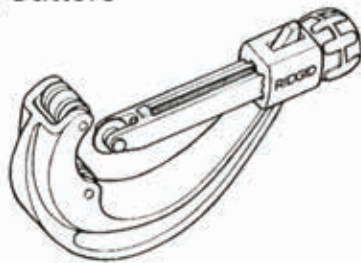

Push the cutter handle to snug the cutter wheel against tubing, press the release nut to automatically snap cutter open. Models 151-156 feature a quick-acting design, I-beam construction, hardened wear surfaces, and thrust bearing slide assemblies for smooth operation. These cutters are available in models for plastic pipe or metallic tubing. Models 151 and 152 feature fold-away reamers.

CAPACITY OD	OEM #	FIG. NO.	PRICE
1/4 - 1 5/8	31632	13580	
1/8 - 1 1/4	31637-P	—	
1/4" - 2 5/8	31642	13581	
1/4 - 2	31647-P	—	
1 - 3	36592-P	13130	
1 7/8 - 4 1/2	31652	13583	
1 1/2 - 4	31657-P	—	
4 - 6 5/8	31662	13584	

*P - Plastic Cutter



DUFF DELIVERS

RIDGID No. 1493 Plastic Pipe and Tube Cutter

Designed for quick, clean cuts through 2 1/2" (60 mm) O.D.



The No. 1493 features a compound leverage ratchet mechanism and a hardened steel blade. Simple operation produces quick, clean cuts with ease. The housing is made of lightweight aluminum for long trouble-free service.

CAPACITY = 1/8" - 2 3/8" OD

OEM #	FIG. NO.	PRICE
1493	2 53	

RIDGID Enclosed Feed Screw Tubing Cutter

Grooved Rollers for Close Flare Cut-Offs



No. 150 and No. 205 feature an enclosed feed screw to eliminate clogging and jamming, grooved rolls for close-to-flare cuts, and a fold-away reamer. No. 205 has a Quick Acting Feed mechanism. Made from high-strength aluminum alloy with a spare cutter wheel in the handle. Cuts copper, brass, and aluminum tubing, and thin-wall conduit.

1/8" through 1 1/8" OD

OEM #	FIG. NO.	PRICE
31622	38760	

1/4" through 2 3/8" OD

33055	13586	
-------	-------	--

1/4" through 2 3/8" OD (HD)

33070	34919	
-------	-------	--

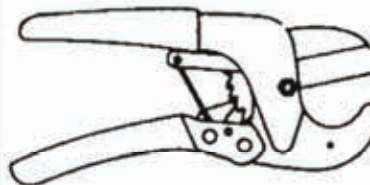

FOR PLASTIC!

CAPACITY — 1/2" to 1-5/8" Ratchet cutter with ergonomic grips

OEM #	FIG. NO.	PRICE
1625	13593	

RIDGID

TUBING CUTTERS



NOS. 10, 15, 20 and 30

Clean, square cuts are easily made on copper, brass aluminum, and thin-wall conduit.

Models 10, 15 and 20 feature a convenient fold-away reamer. Model 30 is rated for larger diameter steel and stainless steel tubing.

TUBING TOOLS

FIG. NO.	MODEL NO.	DESCRIPTION	STD. WHEEL	CAPACITY (IN)	PRICE
13587	10	Screw Feed Cutter	F-158	1/8-1	
—	10	Above w/H-D Wheel	E-1240	1/8-1	
13588	15	Screw Feed Cutter	F-158	3/16-1 1/8	
—	15	Above w/ H-D Wheel	E-1240	3/16-1 1/8	
13589	20	Screw Feed Cutter	F-158	5/8-2 1/8	
34922	20	Above w. H-D Wheel	E-1240	5/8-2 1/8	
13590	30	Screw Feed Cutter	E-2558	1-3 1/8	
—	30	Above w/H-D Wheel	E-2191	1-3 1/8	

TUBING CUTTERS (ORIGINAL PRODUCT)

10	15	20	30	30P	40	40P	50	101	103/104	105/150	106	108	109	109P	131/151	131P/151P	132/152	132P/152P	153	153P	133	133P	134/154	134P/154P	136/156	136P/156P	205	205P	315
32910	32920	32930	32940	32945	32955	32960	41527	40517	32975/32985	32990/31622	33005	83240	83290	83295	33015/31632	33020/31637	33025/31642	33030/31647	36597	36592	33035	33040	33045/31652	33050/31657	83185/31662	83235/31667	33055	33065	33075



FIG. NO.	MODEL NO.	STD. PK.	BLADE EXP.	10	15	20	30	30P	40	40P	50	101	103/104	105/150	106	108	109	109P	131/151	131P/151P	132/152	132P/152P	153	153P	133	133P	134/154	134P/154P	136/156	136P/156P	205	205P	315	APPLICATION		
13653	E-702	1	.500																																Heavy Wall PVC, ABS	
13654	E-1240	12	.162	√	√	√																													Steel - SS	
13655	E-1740	1	.147																																Soft Flexible Plastic	
20091	E-2155	1	.286																		X	X	X										X	PE, PB, PP, STD. & Heavy Wall		
28670	E-2156	1	.412					X	X																X	X									PE, PB, PP, STD. & Heavy Wall	
28671	E-2157	1	.500																																PE, PB, PP, STD. & Heavy Wall	
13656	E-2191	6	.292			√		√																	√	√	√									Steel Tubing
13657	E-2558	6	.220					X	X				X	X	X										X	X	X									Aluminum & Copper
13658	E-2880	1	.747																																PE, PB, PP, STD. & Heavy Wall	
13659	E-2990	1	.112																														X	Steel Aluminum & Copper		
13660	E-3469	12	.149									X	X	X						X	X	X											X	Aluminum & Copper		
28672	E-3495	1	.290																		√	√	√												Aluminum	
13663	E-4546	6	.162																		√	√	√												Steel - SS	
13665	E-5272	6	.290																																PVC, ABS, Std. Wall	
13666	E-5299	6	.412						√	√																√	√	√								PVC, ABS, Std. Wall
13668	E-158	12	.149	X	X	X																													Aluminum Copper	
—	E-10279	1	.185																								√	√							Thin Wall PVC	



RIDGID BOLT CUTTERS

Designed for cutting rod, wire mesh, concrete form ties, cable and bolts.

Slim head permits cutting close to surface. Quick, easy adjustment through use of a cam/bolt mechanism. Jaws are made of hardened alloy steel.

MODEL NO.	FIG. NO.	DESCR	CAPACITY/METALS			LENGTH (IN)
			SOFT	MEDIUM	HARD	
N24S	28681	Center Cut	7/16	3/8	5/16	26

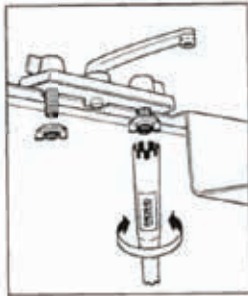

PLASTIC BASIN NUT WRENCH

This wrench is designed to reach and turn plastic mounting nuts on faucets, sprayers and ballcocks. The RIDGID basin wrench is a great addition to any tool box. The notched ends of the plastic basin nut wrench are designed to self-center on 2, 3, 4 and 6-tab nuts and to fit metal and plastic 1" hex nuts. Made of 16 gauge cold rolled steel, it features a one-piece 11" tubular steel body for both residential and commercial faucet water supply shanks. It is ideal for tight clearance pedestal sinks.

FIG. NO.	PRICE
79448	

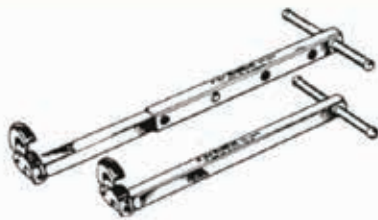

BASIN WRENCHES

Forged alloy jaws are spring loaded to grip all nuts 3/8" through 1 1/4" across flats. You get fast, one-hand ratcheting operation in tight spots. Tension plug holds head in any position up to 90° angle. Handle and shank are chrome plated. Stainless steel spring assures firm grip after positioning jaw on nut, pipe or tube. Telescopic shank is quickly adjusted to desired length and held there by spring loaded pin.

MODEL NO.	FIG. NO.	LENGTH	CAPACITY	PRICE
1017	12940	10"-17"	3/8"-1 1/4" Nuts	
1019	12941	10"-17"	1 1/4"-2 1/2" Nuts	



RIDGID SWAGING TOOLS

Quality made and zinc-plated for accuracy and durability. Set of four tools is packaged in handy vinyl pouch. Designed for copper, aluminum or brass.

MODEL NO.	FIG. NO.	CAPACITY (INCH)	PRICE
570	13621	1/4, 3/8, 1/2, 5/8	



RIDGID INTERNAL WRENCH



MODEL NO.	FIG. NO.
570	13621

TUBING TOOLS

RIDGID INTERNAL TUBING CUTTER

- Model 106 features a tool steel and aluminum body while 108 and 109P have cast iron bodies
- Each model features hardened steel rollers and cutter wheels



Fig. No.	OEM No.	Model No.	Std. Wheel	Capacity	Depth
27681	33005	106	E-2558	2" - 3"	1/4" - 2-5/8"
27682	83240	108	E-2558	1-1/4" - 2"	1/4" - 1-3/4"

RIDGID PRECISION RATCHETING FLARE TOOL

- Flares steel, stainless steel, hard copper and brass tubing - through a wall thickness of 0.035"
- Ratcheting handle reduces effort required especially in confined area
- Handle clutch releases when flare is complete to iron and smooth flare
- Produces 45 degree flare in sizes from 1/8" - 3/4"



Fig. No.	OEM No.	Model No.	Depth
13601	83037	458R	1/4" - 2-5/8"

RIDGID MANUAL FLARE TOOL

- Precision designed tool for producing 45° flares in soft copper, brass, aluminum and mild steel tubing
- A single clamp screw provides for easy clamping and removal of tubing
- Produces 45 degree flare in sizes from 3/16" - 5/8"



Fig. No.	OEM No.	Model No.	Description
27577	23332	345	45° flare
--	23337	345-DL	45° double flare

RIDGID TUBE BENDERS

- Designed for bending annealed copper, steel and stainless with wall thickness less than or equal to .06" to a maximum of 180°



Fig. No.	OEM No.	Model No.	Description
23167	36122	404	1/4"
43740	36097	406	3/8"
43741	36132	408	1/2"

RIDGID GEARED RATCHET TUBE BENDERS

- High geared mechanical ratios, bend heavy-wall steel tube (up to 1/8" wall thickness), stainless steel tube (up to 3/32" wall thickness) and hard copper water tube (types K and L)
- Benders produce uniform bends up to 180°, with no need to anneal tubing or use special temper grade tubing



Fig. No.	OEM No.	Model No.	Description
27577	23332	345	45° flare
--	23337	345-DL	45° double flare



We sell solutions



RIDGID DIE HEADS

These complete die-heads are for use with ratchet type die stocks.

DON'T FORGET CUTTING OIL!

COMPLETE 12R STYLE DIE-HEADS WITH DIES

MODEL NO.	FIG. NO.	SIZE	PRICE
37375	17536	1/8" NPT	
37380	17544	1/4" NPT	
37385	13020	3/8" NPT	
37390	17538	1/2" NPT	
37395	13023	3/4" NPT	
37400	13024	1" NPT	
37405	13026	1 1/4" NPT	
37410	13029	1 1/2" NPT	
37415	13030	2" NPT	
38555	13058	12R ratchet & handle	

COMPLETE 00R STYLE DIE-HEADS WITH DIES

MODEL NO.	FIG. NO.	SIZE	PRICE
36875	12999	For 1/8" NPT	
36880	13000	For 1/4" NPT	
36885	13001	For 3/8" NPT	
36890	13002	For 1/2" NPT	
36895	13004	For 3/4" NPT	
36900	13005	For 1" NPT	
38540	13056	00R ratchet & handle	



RIDGID RATCHET THREADER

Fig. No.	Catalog Number	Description
34403	36345	NPT 00-R 1/2" - 1"
—	36355	NPT 00-R 3/8" - 1"
—	36375	NPT 00-R 1/8" - 1"
—	36480	NPT 12-R 1/2" - 1-1/4"
12949	36475	NPT 12-R 1/2" - 2"
—	36505	NPT 12-R 1/8" - 2"



RIDGID 3-WAY PIPE THREADER

Handy for threading 3 common pipe sizes: 1/2", 3/4" & 1". Supplied with high-speed dies.



RIDGID METAL CARRYING CASE FOR 12R

Steel case with rust-resistant finish to keep your die sets together.

FIG. NO.	PRICE
47213	

OTHER CASES AVAILABLE! PLEASE CALL US AT 610-275-4453

MODEL NO.	FIG. NO.	PRICE
36550	34458	

12R STYLE DIES FOR STAINLESS STEEL (fits OOR, 111R, 12R, OR & 11R die heads)

MODEL NO.	FIG. NO.	SIZE	PRICE
37900	13092	1/8"	
37905	13099	1/4"	
37910	13100	3/8"	
37915	13101	1/2"	
37920	13102	3/4"	
37925	13103	1"	
37930	13104	1-1/4"	
37935	13105	1-1/2"	
37940	13106	2"	

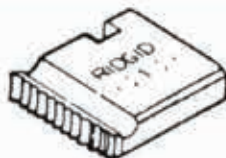

RIDGID PIPE DIES

SEE PAGE 728 FOR CUTTING OIL

SIZE	12R STYLE CARBON DIES (Fits OOR, 12R, or & 11R die heads)			12R STYLE HIGH SPEED DIES (Fits OOR, 12R, or & 11R die heads)		
	MODEL NO.	FIG. NO.	PRICE	MODEL NO.	FIG. NO.	PRICE
1/8"	37810	13059		37855	13075	
1/4"	37815	13061		37860	13076	
3/8"	37820	13063		37865	13078	
1/2"	37825	13066		37870	13082	
3/4"	37830	13068		37875	13083	
1"	37835	13069		37880	13085	
1-1/4"	37840	13071		37885	13087	
1-1/2"	37845	13072		37890	13089	
2"	37850	13073		37895	13090	



For additional information call: 610-275-4453 or Fax: 610-279-6299
Please call for current prices.

RIDGID PIPE DIES

PIPE DIES			
MODEL NO.	FIG. NO.	DESCRIPTION	PRICE
38100	13107	65R Dies, 1"-2" HSS	
38105	34586	65R Dies, HSS for SS	
38120	13108	141 Dies, 2 1/2-4" HSS	
38155	34591	161 Dies, 4-6" HSS	
26192	34691	1224 Mach. Dies 2 1/2-4"	
70640	34586	141 HSS Dies for SS, 2 1/2-4"	
ALLOY UNIVERSAL DIES			
47735	13190	1/8" NPT Dies	
47740	13195	1/4" - 3/8" NPT Dies	
47745	13197	1/2" - 3/4" NPT Dies	
47750	27563	1" - 2" NPT Dies	
HIGH SPEED STEEL UNIVERSAL DIES			
47755	13210	1/8" NPT Dies HSS	
47760	13212	1/4" - 3/8" NPT Dies HSS	
47765	13216	1/2" - 3/4" NPT Dies HSS	
47770	27565	1" - 2" NPT Dies HSS	
UNIVERSAL DIES FOR STAINLESS STEEL			
47775	—	1/8" NPT Dies for HSS	
47780	—	1/4" - 3/8" NPT Dies for HSS	
47785	13576	1/2" - 3/4" NPT Dies for HSS	
47790	17540	1" - 2" NPT Dies for HSS	
UNIVERSAL DIES FOR PVC			
70745	—	1/2" - 3/4" NPT Dies	
70750	—	1" - 2" NPT Dies	

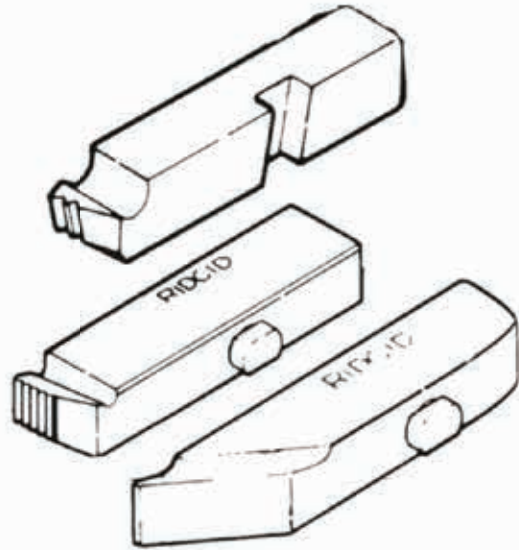

DON'T FORGET CUTTING OIL!

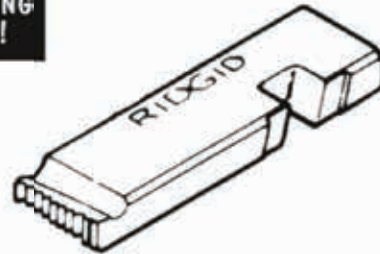



DUFF CO.

SEARCH MENU

810-279-4453

HOME

DEPARTMENTS

RESOURCES

HELP & SUPPORT

CONTACT US

ABOUT US



COMMERCIAL & RESIDENTIAL WATER TREATMENT SYSTEMS & SUPPLIES

[READ MORE](#)



PIPE VISES



PORTABLE TRISTAND
CHAIN VISE



PORTABLE TRISTAND
YOKE VISE



BENCH YOKE VISE



TOP SCREW POST
CHAIN VISE



TOP SCREW STAND
CHAIN VISE



TOP SCREW
BENCH CHAIN
VISE



BOTTOM SCREW
BENCH CHAIN
VISE

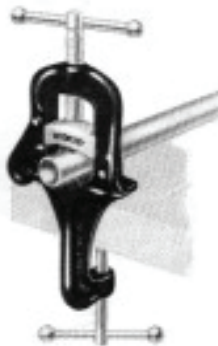

PORTABLE KIT
YOKE VISE
(FITS 4" PLANK)

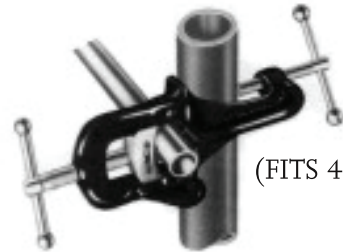

(FITS 4" POST)



FLANGE PIPE
WELDING VISE

PIPE VISES

FIG. NO.	MODEL NO.	DESCRIPTION	PIPE CAPACITY (IN)	WEIGHT	PRICE
21886	40-A	Portable trisland yoke vise	1/8-2 1/2	48 1/2	
13113	460	Portable trisland chain Vise**	1/8-5	45 1/2	
—	560	Top screw stand chain vise	1/8-5	25 3/4	
13114	BC210	Top screw stand chain vise	1/8-2 1/2	7 3/4	
13115	BC410	Top screw bench chain vise	1/8-4	14 3/4	
—	BV210P	Top screw bench chain vise	1/2-2 7/8OD*	7 1/2	
—	BC410P	Top screw bench chain vise	1/2-4 1/2OD*	14 1/2	
28175	BC510	Top screw bench chain vise	1/8-5	15	
—	BC610	Top screw bench chain vise	1/4-6	24 1/2	
—	BC810	Top screw bench chain vise	1/2-8	38	
—	BC2A	Bottom screw bench chain vise	1/8-2	5 3/4	
—	BC4A	Bottom screw bench chain vise	1/8-4	13	
—	20	Bench yoke vise	1/8-1 1/4	4	
27639	21	Bench yoke vise	1/8-2	8 3/4	
—	22	Bench yoke vise	1/8-2 1/2	13	
—	23	Bench yoke vise	1/8-3	19 3/4	
—	25	Bench yoke vise	1/8-4	27 3/4	
—	27	Bench yoke vise	1/8-6	65	
—	640	Top screw post chain vise	1/8-5	23 1/2	
—	38	Portable kit yoke vise	1/8-2	12	
—	39	Portable kit yoke vise	1/8-2 1/2	15 1/2	
—	463	Elbow pipe welding vise	2 1/2-8	14	
—	464	Flange pipe welding vise	2 1/2-8	17 1/4	



12994

POWER THREADER

- *Threads 1"-2" pipe
- *True centering workholder
- *Jam-proof
- *Right hand only
- *NPT with 1 set high speed dies



34478

POWER THREADER

- *Threads 1"-2" pipe
- *Jam-proof drive pawl
- *Cam workholder set instantly
- *Right hand only
- *NPT with 1 set high speed dies

MODEL NO.	FIG. NO.	CAPACITY (INCH)	WGHT (LB)	PRICE
65R-C	34478	1-2	25	
65R-TC	12994	1-2	27	

GEARED THREADER

- *12996 threads 2 1/2", 3", 3 1/2", 4" pipe with one set of dies
- *34484 threads 4", 4 1/2", 5", 6" pipe with one set of dies
- *Jaw clutch prevents jamming
- *Simple adjustment for tapered or straight threads
- *Cam-type workholder set instantly
- *Fully enclosed gearing
- *Right hand only
- *NPT with 1 set of high speed dies



MODEL NO.	FIG. NO.	CAPACITY (INCH)	WGHT (LB)	PRICE
141	12996	2 1/2-4	93	
161	34484	4-6	158	

RIDGID HAMMERS



CURVED CLAW



RIPPING CLAW



BALL PEIN



SHORT HANDLED
SLEDGE



HAND DRILLING
HAMMER

Fig. No.	Catalog Number	Model No.	Description	Overall Length	Weight (lbs.)
27688	52475	116	16 oz. Curved Claw Hammer	13-1/4"	1-1/2
27689	52480	120	20 oz. Curved Claw Hammer	13-1/4"	1-3/4
	52485	216	16 oz. Ripping Claw Hammer	13-1/4"	1-1/2
27691	52490	220	20 oz. Ripping Claw Hammer	13-1/4"	1-3/4
27693	52450	12	12 oz. Ball Pein Hammer	13"	1-1/8
	52455	16	16 oz. Ball Pein Hammer	14"	1-1/2
	52465	24	24 oz. Ball Pein Hammer	15-1/2"	2-1/8
	52470	32	32 oz. Ball Pein Hammer	16"	2-3/4
27698	52495	250	2 1/2 lb. Short Handled Sledge	15-1/2"	3-1/4
137197	52505	303	3 lb. Hand Drilling Hammer	10"	3-1/2



WRENCHES

RIDGID Heavy-Duty Pipe Wrenches



The original heavy-duty pipe wrench, known for its serviceability. Replaceable jaws are made of hardened alloy steel. Full floating hook jaw gives instant grip and release. Handy pipe scale and large easy-to-spin adjusting nut allow fast, one-hand setting to pipe size. Comfort grip, malleable iron I-beam handle.

OEM #	WRENCH SIZE	CAPACITY	FIG. NO.	PRICE
31000	6"	3/4	12774	
31005	8"	1	12778	
31010	10"	1 1/2	12780	
31015	12"	2	12783	
31020	14"	2	12787	
31025	18"	2 1/2	12790	
31030	24"	3	12795	
31035	36"	5	12797	
31040	48"	6	12799	
31045	60"	8	12802	

RIDGID Heavy Duty Offset Pipe Wrench



These wrenches are just as strong as regular RIDGID heavy-duty wrenches of the same size. Jaw opening parallels handle making these ideal wrenches for fast, easy, one-hand operation overhead or in tight places. Spring suspended hook jaw gives tight grip, fast release. Narrow jaw head fits into close quarters. Adjusting nut turns easily for fast size adjustment.

OEM #	WRENCH SIZE	CAPACITY	FIG. NO.	PRICE
89435	14"	1/8 - 2"	12832	
89440	18"	1/4 - 2 1/2"	12835	
89445	24"	1/4 - 3"	12897	

For Aluminum handles, please see next page ...

RIDGID Aluminum Handle Straight Pipe Wrenches

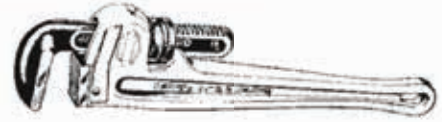

Aluminum handles make these heavy-duty wrenches almost 40% lighter than similar wrenches with malleable iron handles. Parts are identical to those of RIDGID Straight Pipe Wrenches. Ideal for over head work. Also available with special hook and heel jaws for plastic pipe.

OEM #	WRENCH SIZE	CAPACITY	FIG. NO.	PRICE
31090	10	1 1/2"	12898	
31095	14	2"	12900	
31100	18	2 1/2"	12901	
31105	24	3"	12903	
31110	36	5"	12904	
31115	48	6"	12906	



RIDGID Heavy-Duty Chain Wrenches

The design of these rugged wrenches makes it easier to work in extra close quarters . . . on round, square or irregular shapes. Fast ratchet-like action lets you work from either side. Hardened alloy steel jaws are replaceable. Tempered steel chain is held securely in double lock grips, releases quickly.

OEM #	CHAIN LENGTH	CAPACITY	FIG. NO.	PRICE
31315	18 9/16"	2/5	12909	
31320	20 1/4"	2.5/5	12911	
31325	20 1/4"	3/5	12912	
31330	28 7/8"	4.4/7.5	12916	

CAPACITY = ACTUAL/RATED

Ridgid RapidGrip Wrench



Fig. No.	OEM No.	Type
—	10348	Heavy duty steel 10"
136889	10358	Heavy duty steel 14"
—	12693	Aluminum 14"
—	12698	Aluminum 18"

Ridgid Spud Wrench



Fig. No.	OEM No.	Type
18165	31400	Heavy duty steel 12"

Ridgid Internal Wrench



Fig. No.	OEM No.	Type
12938	31405	Installs or extracts 1" - 2" spuds & nipples

WRENCHES

RIDGID

Strap Wrenches



For use on polished pipe and tubing - protects nickel and chrome finish. Strong I-beam handle and solid head, all one piece. Handy hang-up hole. Easy to attach and use. Straps are easily replaced . . . easy to use.

OEM #	CAPACITY	STRAP WXL	FIG. NO.	PRICE
31340	1/8 - 2"	1 1/8-17	12918	
31350		1 1/2-24	27498	
31360	1 - 5"	1 3/4-29 1/4	12921	
31365		1 3/4 - 48	27500	
31370	1 - 5.5"	1 3/4-29 1/4	18810	

RIDGID

No. E-110 Offset Hex Wrench



Extra-wide-opening offset jaw gives easy-on, non-slip grip on sink and tube drain nuts . . . all other hard-to-get-at nuts and fittings. Thin, smooth jaws slip into tightest places. Short handle makes work easy in close quarters. Multi-sided grip allows extra leverage.

OEM #	31305
MAX JAW OPENING	2 5/8"
NUT CAPACITY	UP THRU 1 1/2"
HNDLE LENGTH	9 1/2"
FIG. NO.	12922
PRICE	

RIDGID Aluminum Handle

Offset Pipe Wrench



Aluminum Handle Offset Pipe Wrenches featuring a jaw opening parallel to lightweight aluminum handle. These wrenches are almost 50% lighter, but just as strong as regular RIDGID Wrenches of the same size. Housing is replaced free if it ever breaks or distorts. Hook jaw head is narrower to give easy entry into tight spots. Combination of light aluminum handle and forward facing jaw makes overhead or tight quarter work fast and easy. Adjusting nut turns easily for fast size adjustment. Jaws are made of strong alloy steel, then hardened.

OEM #	WRENCH SIZE	CAPACITY	FIG. NO.	PRICE
31120	14"	2"	38787	
31125	18"	2 1/2"	38788	
31130	24"	3	38789	

RIDGID

Nos. 1-A & 2-A Heavy-Duty Pipe Cutters



Gives fast, clean pipe cutting by hand or power. Extra long shank protects adjustment threads. Extra large handle for quick, easy adjustment. Balanced frame of special malleable iron. Equipped with tough blade cutter wheel. Can convert to 3-wheel cutter by replacing rollers with cutter wheels.

OEM #	CAP	FIG. NO.	PRICE
32810	1/8 - 1 1/4	13119	
32820	1/8 - 2	13121	

RIDGID

No. 202 Wide-Roll Pipe Cutter



Featuring extra wide rolls, this Heavy-Duty Cutter is especially designed for use with Power Drives. Wide rolls prevent cock or wobble of cutter for perfect tracking, cleaner cuts. Capacity 1/4" through 2".

OEM #	CAP	FIG. NO.	PRICE
32895	1/8 - 2	20249	

RIDGID

Nos 3-S, 4-S & 6-S Heavy-Duty Pipe Cutters



Large handle assures sure grip, easy adjustment. Second handle gives added leverage for large size pipe cutting jobs. Can be converted to 3-wheel cutter by replacing rollers with cutter wheels.

OEM #	CAP	FIG. NO.	PRICE
32830	1 - 3	17539	
32840	2 - 4	13125	
32850	4 - 6	13127	

FOR REPLACEMENT STRAPS, CUTTER WHEELS AND WRENCH PARTS, SEE PAGE 667

RIDGID TOOLS

RIDGID

No. 2-S Spiral Ratchet Pipe Reamer

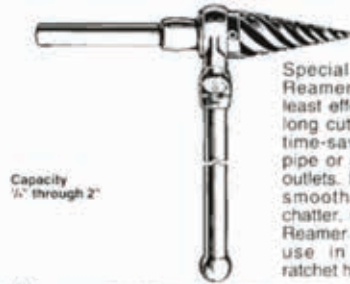

Capacity
1/2" through 2"

Special spiral design of 2-S Reamer cuts into metal with least effort — fast, clean cuts, long cutting life. Makes easy, time-saving work of reaming pipe or enlarging conduit box outlets. Reams sheet metal — smooth and easy without chatter. Complete with handle. Reamer unit available alone for use in RIDGID No. 00-R ratchet handle.

OEM #	DESCR	FIG. NO.	PRICE
34955	complete	—	

RIDGID Pipe Welding Vises

Four Models Align and Hold Pipe for Straight, Elbow, Flange or Angle Track Welding.

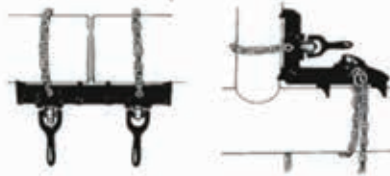

No. 461 Straight Pipe Welding Vise — Used on mains and risers for aligning and holding the pipe which is to be tacked. Holds pipe from 1/2" through 8".

No. 462 Angle Pipe Welding Vise — Used on headers, drips and branches up through 12". Holds branch line at right angle to main or header for layout and cutting.

OEM #	FIG. NO.	PRICE
461 (Straight)	—	
462 (Angle)	—	

RIDGID No. 418 Oiler

Stops Oil Waste, Keeps Dies Flooded for Perfect Threads, Longer Die Life!



Hand-operated continuous oiler pumps easily by thumb action. Large chip pan catches oil runoff, chips and scraps. No messy floors. Oil is double-screened and recirculated through reservoir, hose and hand pump. Completely portable. Quickly pays for itself in oil savings alone. Chip pan is 14 1/2" in diameter, 8 1/2" high. Hose length, 48".

OEM #	FIG. NO.	PRICE
41650	13138	



RIDGID

4-Wheel Pipe Cutters



These 4-wheel cutters are designed for work in areas where a complete turn is impossible. No. 42-A has short handle for use in extra-tight places where only a quarter turn can be made. Second handle on No. 44-S makes 2-man leverage possible on large pipe sizes. Both are equipped with 4 Heavy-Duty Wheels.

OEM #	CAP	FIG. NO.	PRICE
32870	3/4 - 2	27588	

RIDGID No. 700 Portable Power Drive

Threading Capacity:
1/2" through 2" pipe and conduit
1/2" through 1" rod



Heavy-Duty Power for Threading and Driving Geared Threaders

The RIDGID No. 700 Power Drive is compact, powerful, engineered and built for complete utility and trouble-free service. Plenty of power to cut threads and drive geared threaders. Reversible motor and all-spur gear reduction assure maximum power and efficiency. Die heads and adapters lock in securely from either side. RIDGID No. 12-R Die Heads fit without an adapter while only four adapters are needed for other RIDGID Die Heads. A Square Drive Adapter is used for RIDGID Geared Threaders. Gear case, housing and handle are rugged cast aluminum for strength without added weight. Motor: Universal, 1/2 hp, 115 or 230 volt, ac (25-60 Hz), reversible, 3 pole, double throw (reversible) switch with spring return to center "off" position.

DESCRIPTION	OEM #	FIG NO	PRICE
Portable Power Drive	41935	13147	
Adapter for 00-R and 00-RB Die Heads	42600	—	
Adapter for 11-R die head	42610	—	
Adapter for 111-R die head	42615	—	
Square Drive Adapter	42620	34630	
Carrying case for 700 series	42950	34632	

RIDGID No. 775 Support Arm for 700 Power Drive

No. 775 Support Arm improves overall thread cutting operation of the No. 700. No. 775 provides the guide for straight threads and eliminates possibility of damage to spline end of die head by keeping power drive square to pipe. By taking torque and being clamped securely onto pipe or conduit, the Support Arm also contributes to a safer threading operation.



OEM #	FIG. NO.	PRICE
42625	34631	

RIDGID MACHINES

RIDGID No. 535 Pipe & Bolt

Threading Machine

Capacity 1/2" thru 2" Pipe;
1/2" thru 2" Bolts

Ideal for bench or stand mounting. It threads, cuts and reams... even cuts close nipples when you use a No. 819 Nipple Chuck. Popular Speed Chuck sets and releases by hand... holds tight, forward or reverse. 3-jaw rear centering device centers long lengths for true threads and cuts. Integral foot switch provides safer operation. Pipe can be chucked from front. All tools operate independently, swing up out of way when not in use. Lathe-type adjusting handle moves carriage accurately, smoothly. Easy-to-read length gauge gives fast, exact cutoffs. Reversible vane-type pump recirculates and cleans thread cutting oil. 1/2 h.p. single phase 115 volt, AC, 25-60 cycle Universal motor is reversible at switch. 230 volt motor available. All RIDGID quick-opening Pipe and Bolt Machine Die Heads and Dies can be used.

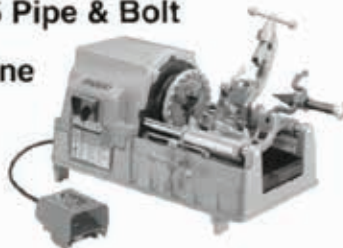

Machine with standard equipment cutter, reamer, 1 gallon RIDGID nuclear thread cutting oil, 4 hex keys, 1 spare cutter wheel and lubricating grease, but LESS all die heads and dies. No. 820 wheel-type cut-off.

OEM #	FIG. NO.	PRICE
96502	34713	

RIDGID



NO. 206 PIPE CUTTER

Cuts 2"-6" No Hub soil pipe. Lighter weight and closer spacing of cutter wheels, together with simple ratcheting action, give smooth cut on lighter wallpipe. Ratchet-action handle parallels pipe so trench can be minimum width. Complete with hand guard to protect operator's knuckles at time of cut.

OEM #	FIG. NO.	PRICE
68650	27562	

TORQUE WRENCH



	OEM #	FIG. NO.
RIDGID	31410	13134
GENERIC	—	50065

RIDGID No. 1224 Pipe & Bolt

Threading Machine

Capacity 1/2" thru 4" pipe
1/2" thru 2" bolts

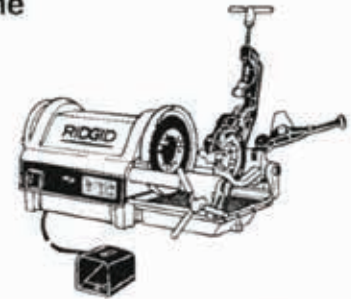

The RIDGID No. 1224 Threading Machine is designed to thread 1/2" through 4" pipe and conduit, 1/2" through 2" rod (bolt stock). Speed Chuck sets and releases by hand... holds tight, forward or reverse. 3-jaw rear centering device centers long lengths for true threads and cuts. Integral foot switch provides safer operation. All existing RIDGID universal and 500B dies can be used with the No. 1224 Threading Machine. 2 1/2" - 4" receding die head is able to cut lapped or straight threads (NPT or NPSM/BSPT or BSPP) with no change of dies or accessories. The die head is fully automatic with one hand operation. 1 1/2 H.P. single phase, 115V, 60 Hz or 50 Hz induction type motor. Cuts close nipples with No. 819 Nipple Chuck.

Includes standard equipment (cutter, reamer, 1 gallon RIDGID thread cutting oil, 4 hex keys, spare cutter wheel, 3/4" combination wrench, tool box and lubricating grease), but LESS all die heads and dies. No. 764 wheel-type cut-off.

OEM #	FIG. NO.	PRICE
26092	34680	

RIDGID No. 246 Soil Pipe Cutter

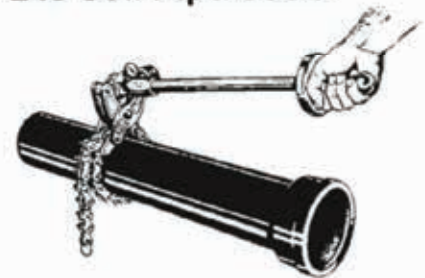

Lightest, Most Compact, Most Powerful in its 2" through 6" Size Range

High mechanical advantage gives this light (24 lbs.), compact cutter plenty of power to cut all 2" thru 6" clay, cast iron, asbestos, cement pipe and through Class 22, 4" water main. One man handles it in tightest quarters. Since ratchet action parallels pipe, pipe becomes second lever and helper as well. A few easy pumps of handle tighten chain until pipe is severed. Hand guard protects operator's knuckles at time of cut. Made of all alloy heat-treated steel, all parts are plated or painted... will not corrode. Threaded parts are sealed to keep dirt and moisture out... lubrication in.

OEM #	FIG. NO.	PRICE
32900	13133	

RIDGID THREADING MACHINES

RIDGID MODEL 1215 THREADING MACHINE

- Compact, lightweight design.
- One-piece aluminum housing.
- Two easy-to-use carrying handles.
- Integral foot switch hanger.
- Powerful motor and transmission.
- Through die head oiling.
- Adjustable oil flow control.
- Approved by CSA to CSA and UL standards (115V only)

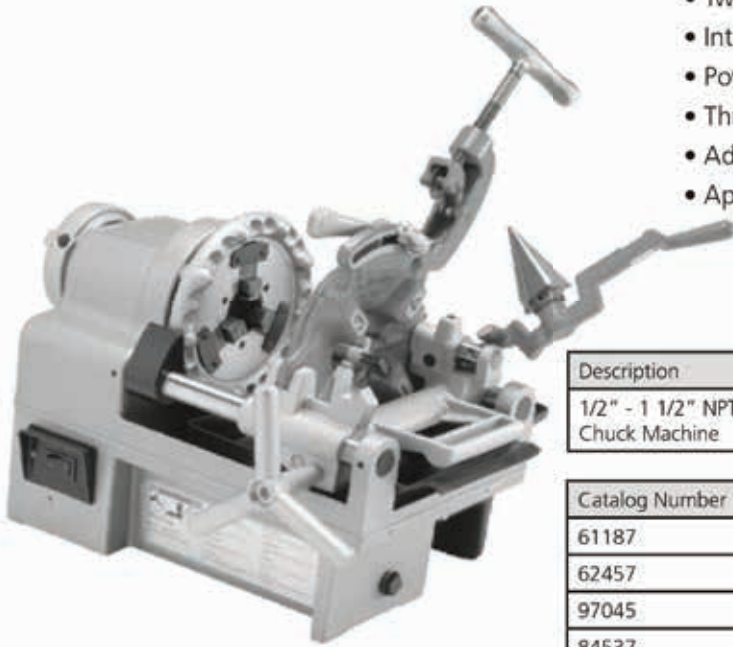

Description	Die Head	RPM	Voltage	Amp Draw (A)	Power
1/2" - 1 1/2" NPT Hammer Chuck Machine	811A	44	115v	24	1/2 HP

Catalog Number	Model No.	Description
61187	1203	Tripod Stand
62457	1219	Nipple Chuck, NPT For 1215
97045	531	Bolt Die Head Quick-Open R.H./L.H. 1/4"-1"
84537	816	1/8" - 3/4" Semi-Automatic Die Head
84532	817	1/2" - 2" Semi-Automatic Die Head

RIDGID MODEL 300 COMPACT THREADING MACHINE



The most powerful and portable 2" machine available today. Features include: folding stand and oil seal for easy transport; self-contained oil system with through-the-die-head oiling; easy clip for footswitch, optional adapter to mount 916 groover; quiet operation with 1/2 HP 115 v motor producing 38 rpm.

CAPACITY: Pipe 1/8"-2"; bolt 1/4" - 2"

STANDARD EQUIPMENT

- 1/8"-2" universal die head
- 1 - 360 Cutter with E-1032 cutter wheel
- 1 - 344 Cone-type reamer
- 1 - Set of 1/2" - 3/4" alloy universal dies
- 1 - Set of 1" - 2" alloy universal dies
- 1 - Gallon Nu-Clear thread cutting oil

DESCR	FIG. NO.	PRICE
300 Compact w/ stand	—	
815A 50 Univ Head	34638	
811A QO Univ Head	19495	
531 1/4"-1" Bolt Head	—	
532 1-1/4"-2" Bolt Head	—	
916 Groover Bracket	—	
Nipple Chuck, 1/2"-2"	13179	

RIDGID

RIDGID Accessories

for No. 300 Power Drive

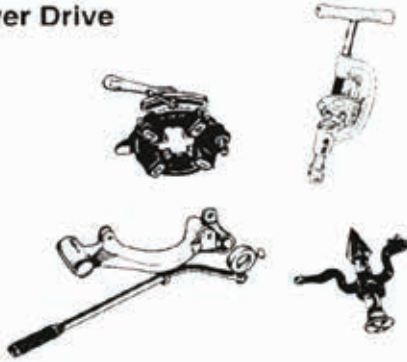

RIDGID No. 811A Quick-Opening Die Heads or No. 815A Self-Opening Die Head.

RIDGID Universal Quick-Opening Die Head or No. 815 Self-Opening Die Head snap-locks into carriage quickly, easily . . . eliminates slow back-off! Single adjustment on carriage centers die heads for true threads.

OEM #	FIG. NO.	DESCR	PRICE
97065	19495	Fig - 1 1/8" - 2" Rod - 1 1/4" - 2"	
97075	34638	Fig - 1 7/8" - 2" Rod - 1 1/4" - 2"	

RIDGID No. 311 Carriage with Lever for No. 300 Power Drive

Slip this strong carriage on your RIDGID 300 Power Drive, with 2 support bars, and you'll get fast cut-and-thread efficiency. Holds die head, cutter and reamer at your fingertips exactly like a Pipe Machine. No tools to drop. Easy sliding . . . snugs right up to chuck for close threading and cut-off. Die head and cutter operate independently . . . swings up and stays out of way when not in use. Add a RIDGID No. 819 Nipple Chuck, and you can thread close nipples.

OEM #	FIG. NO.	PRICE
68815	34636	

RIDGID No. 360 Cutter

3/4" through 2" Pipe, 1/2" through 3/4". Rod with No. 1 & 2 Wheels, 1/4" through 1" Rod with E-1032 Cutter Wheel

Full-floating, wheel-type cutter . . . wide rolls for straight cuts at Pipe Machine speed. Attaches easily with swivel drive pin. Fits 311 Carriage.

OEM #	FIG. NO.	PRICE
42370	13170	

RIDGID No. 341 Reamer

This rugged reamer smooths inside edges of pipe fast and easy with five-flute cone. Handles all 1/2" through 2" pipe or conduit. Short length permits reaming of "close" nipples. Fits 311 Carriage.

OEM #	FIG. NO.	PRICE
42365	13167	

RIDGID No. 312 Carriage Lever

RIDGID No. 312 Carriage Lever gives fast, easy positioning of die head, cutter or reamer . . . increases leverage for quicker threading and reaming.

OEM #	FIG. NO.	PRICE
42385	34637	

RIDGID NO. 300 POWER DRIVE COMPLETE

Model 300 Power Drive Complete Consists of:

- 300 Power Drive with Foot Switch
- Set 1 1/2" - 3 1/4" Universal Alloy Dies
- Set 1" - 2" Universal Alloy Dies
- 311 Carriage with Lever
- 811A Universal Die Head
- 32 Transporter
- 1452 Removable Tray
- 1206 Stand
- Reamer
- 360 Cutter
- 418 Oiler
- 1 Gallon Nu-Clear Thread Cutting Oil



Fig. No.	OEM No.	Description	Pipe Threading Capacity
34663	15682	115V, 38RPM	1/8" - 2"
34664	15722	115V, 57RPM	1/8" - 2"

RIDGID No. 1206 Stand for No. 300 Power Drive

When you take your RIDGID 300 Power Drive out on the job, here's just what you'll need for easy portability and time-saving work base. Integral folding legs and tray are extra rigid when opened for use . . . fold and chain lock closed for easy carrying . . . no loose parts.



OEM #	FIG. NO.	PRICE
42360	13164	

RIDGID No. 916 Roll Groover

RIDGID Model 916 Roll Groover is the most durable and mechanically efficient lightweight portable unit available. Built with a solid, durable cast-iron housing, it can withstand heavy usage, but is light enough for easy transportation on the job site. The 916 features a unique feed mechanism that is quick and efficient allowing for effortless and accurate operation.



OEM #	FIG. NO.	PRICE
45007	76200	

RIDGID PARTS

WRENCH PARTS

STR	END	IRON HANDLE STRGHT WRENCH	PRICE	IRON HANDLE END WRENCH	PRICE	ALUM HANDLE STRGHT WRENCH	PRICE	NUT	PRICE	JAW PIN	PRICE	HEEL JAW & PIN ASSEMBLY	PRICE	COIL & FLAT SPRING ASSEMBLY	PRICE	HOOK JAW	PRICE
6	E-6	-		34356		-		12706		34370		17524		12767		12873	
8	E-8	34346		34357		-		12707		34371		12724		17527		12876	
10	E-10	34347		34358		34364		12709		34372		17525		12849		12882	
12	E-12	34348		34359		-		12710		34373		12730		17528		12885	
14	E-14	34349		34360		34365		12711		34373		12730		12855		12887	
18	E-18	34350		34361		34366		12713		34374		12744		17529		12888	
24	E-24	34351		34362		34367		12715		34375		12749		12862		12890	
36	E-36	34352		34363		34368		12717		34376		12758		12865		12891	
48	-	34353		-		34369		12719		34377		12760		12868		12893	
60	-	34354		-		-		12720		34378		17526		12871		12894	
10" Wrap Wrench		34355		-		-		12709		34372		17525		12849		12882	

RIDGID Pipe Cutter Wheels



Wheel For Cast Iron Pipe



Standard Thin Wheel



Heavy-Duty Wheel

OEM #	TYPE	FOR RIDGID PIPE CUTTER NO'S	FIG.NO.	PRICE
44185	E1032	360, 820	13677	
44190	1032SS	360, 820	13680	
83140	R83140	466C, 466S, 477HWS, 468C, 468S, 468HWS, 472C, 472S, 472HWS	28674	13697
33110	F514	1A, 2A, 42A, 202, 360, 820	13697	
33120	F515	3S, 4S, 44S, 466C, 466S, 466HWS, 468C, 468S, 468HWS, 472C, 472S, 472HWS	13700	
33105	F3	1A, 2A, 2, 42A, 202, 360, 820	13686	
33125	F229	3S, 4S, 44S, 466C, 466S, 466HWS, 468C, 468S, 468HWS, 472C, 472S, 472HWS	13691	
33145	F367	6S, 208, 209	13695	
33115	F119	1A, 2A, 42A, 202, 360, 820	28675	28673
33135	E1962	3S, 4S, 44S, 466C, 466S, 466HWS, 468C, 468S, 468HWS, 472C, 472S, 472HWS	28677	
33155	F383	6S, 208	13675	
33220	E109	206	13684	
33225	E2632	246	13687	
33110	F355S	1A, 2A, 42A, 202, 360, 820	13693	
33130	F229S	3S, 4S, 44S, 466C, 466S, 466HWS, 468C, 468S, 468HWS, 472C, 472S, 472HWS	13696	
33150	F367S	6S, 208, 209		

REPLACEMENT STRAPS

STRAP WIDTH INCHES	STRAP WIDTH MM	FIG. NO.	PRICE
1/2	12	34381	
1 1/8	30	30499	
1 1/8	30	34382	
1 1/8	30	34383	
1 3/4	45	22976	
1 3/4	45	34384	
1 1/16	27	34385	
1 3/4	45	34386	

SEE PAGE 662 FOR COMPLETE STRAP WRENCH

FAX YOUR ORDER TODAY!

610-279-6299

RIDGID TAPPING TOOLS — HOT TAP

RT3422



RT1000



- Easy to use. At only 21", this lightweight and compact tool is great for tight quarters and awkward locations.
- Heavy-Duty Design. Sturdy machined, corrosion-resistant materials for dependable lifelong benefits.
- Built-in bleed valve. Allows for easy purge of chips.
- Independent cutter feed mechanism gives the operator full control of drilling to optimize cutter performance and service life.
- Independent cutter feed gives the operator total independent control of the cutter feed rotation for optimal saw life.
- Taps a variety of materials. The RT3422 is capable of tapping into steel, cast iron, ductile iron and plastic pipe.
- Versatility. The RT3422 is capable of tapping mains of water up to 500 psig and steam, air, and natural gas up to 150 psig.
- Coupon retaining bits. Exclusive pilot bits give you the confidence that the coupon will not be dropped in the pipe, preventing medium contamination or possible damage of downstream equipment.

- Compact and lightweight, the tool is great for tight quarters and awkward locations.
- Sturdy machined construction and corrosion-resistant materials combine to provide dependable lifelong operation.
- Independent cutter feed mechanism gives the operator full control of drilling to optimize cutter performance and service life.
- Taps steel, cast iron, ductile iron and plastic pipe.
- Coupon retaining bits give you the confidence that the coupon will not be dropped in the pipe, preventing medium contamination or possible damage of downstream equipment.

RIDGID



First thing
this morning,
there was a tap
on my door.

Really? I thought
the plumber wasn't
coming until noon.



RIDGID MISCELLANEOUS TOOLS

RIDGID No. 1202

Universal Saw



Ideal for clean, accurate cutting of plastic pipe, laminates, plywood and veneers. Tough, polished steel, 14 TPI (12 1/2") blade. Comfort-grip plastic handle. Doubles as excellent miter box saw. Special toothing on curved back edge cuts slots.

OEM #	FIG. NO.	PRICE
35990	13637	

RIDGID

Automatic Locking Steel Tapes

Mfrs. Code No. 785461

Blade Locks Where You Want It. Rewinds Automatically



Chromium plated inside-outside case has button control for locking and power rewinding of tape. Removable belt clip. Tempered steel blade is finished in white enamel and coated with Mylar® for lasting protection. Self-adjusting inside-outside end hook. Stud marks every 16 inches. Replaceable blade. No. 665 is Metric/English with millimeters on upper edge of blade and inches on lower edge.

OEM #	Width	Length	Fig. No.	Price
90260	3/4"	25'	13632	

RIDGID Cold Chisels and Chisel Sets

Made from chrome alloy steel. Heat treated and drawn to insure maximum durability at the working end and maximum impact resistance at the striking end. Shank is square for easy gripping and prevents tools from rotating off work area. Nickel chrome plated for corrosion resistance.

Cold Chisel: Cut cold metal such as brass, bronze, copper, iron, cast iron, aluminum, rivets, nuts and bolts.

OEM #	FIG. NO.	PRICE
31592	35073	



RIDGID Shovels



Professional Quality, Precision-Built For Long Hard Service
Super-strong, light weight, extra-durable. Shovel blades and shanks are one-piece, rust-proofed, 16 gauge steel, taper forged, then heat treated. Round blades have slip resistant, turned step. Handles are burnished, lacquered ash, double riveted to blade socket.

DESCR	OEM #	FIG. NO.	PRICE
Lg Hndle Rd Pt Shovel	52300	—	
Lg Hndle Sq Pt Shovel	52305	—	
D Hndle Rd Pt Shovel	52310	—	
D Hndle Sq Pt Shovel	52315	—	
D Handle Scoop Shovel	88680	—	

GOT QUESTIONS... CALL:



RIDGID Fiberglass Folding Rules

INSIDE



OUTSIDE



EXTENSION



Extremely flexible, rugged construction. Designed for years of accurate service.

Precision-made of durable, heavy duty fiberglass. Have easy-to-read, embedded, bold face figures and graduations. Red 16" stud marks. Easy-action positive locking joints. All rules 1/2" wide.

OEM #	Descr	Width	Length	Fig. No.	Price
73365	Outside	5/8"	6'	13628	
73370	Inside	5/8"	6'	27518	
73360	Ext	5/8"	6'	13629	

FREEZE KITS FOR PIPE AND TUBE REPAIR



General Wire Cold-Shot Freeze Kit
For tubing repair - Freezes lines from 1/8" pipe to 2" pipe. 1/2" Copper to 2 1/2" Copper. 10 sizes of freeze heads. Use with CO2 cylinder. Environmentally safe!

Fig. No.
16308

DUFFNOTE:

For PIPE REPAIRS,
See page 64-65.

For ADD-A-VALVE,
See Repair Clamps
on pages 39.

For EPOXYS,
See page 815.

FREEZE KITS

Ridgid SF-2500 SuperFreeze

- SuperFreeze Unit
- Two Velcro Straps
- Water Bottle
- Clamp
- Special Freeze Gel (speeds up freezing time)

Capacity — Copper Tube: 1/2 - 2 1/2". Steel Pipe: 1/2 - 2"
Compressor — 115V, 4.3A
Hose Length — 8.5' (17' span)

Fig. No.	OEM No.
—	68967



Blue Monster Compression Seal Tape

- Stops nasty leaks under pressure without turning off the water source.
- Seal leaks up to 150 PSI (water, air, steam)
- Self-fusing layers for a waterproof, long-term compression seal



Fig. No.	OEM No.	Type
276945	76085	1" x 12' roll
—	76086	2" x 12' roll



Water-Activated Fiberglass Pipe Repair Kit

- Water activated fiberglass wrap
- Heat resistant to 425° F
- Conforms to a standard water main pressure test
- Works on wet or dry surfaces
- Cures in 30-90 minutes



Fig. No.	Type
82098	2" x 48" to repair up to 1" diameter pipe
82099	3" x 132" to repair from 1 1/4" to 3" dia. pipe
320767	4" x 252" to repair from 3" to 6" dia. pipe



FLOOD GUARD operates like a check valve to seal off water back-up caused by overloaded sewers. Water flows normally through the drain until the sewer begins to back up. Then the FLOOD GUARD float rises to seal off the drain opening until the water recedes.

A screwdriver and a couple of minutes area all you need to install a FLOOD GUARD. Once in place, it can prevent property damage and a very messy clean-up job.

Gaskets are made of molded rubber, and all metal parts are plated, except for screws and float rod, which are solid brass.

Fig. No.	Type
15346	2"
15347	3"
15348	4"

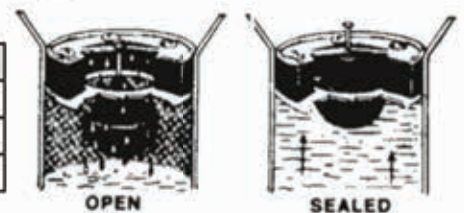

MISCELLANEOUS TOOLS

PIPE - N - HOT

Pipe Thawer No more Blowtorches!



- Portable
- 115 Volt
- sturdy low voltage output
- circuit breaker protected
- guaranteed for 2 years.
- with two 20' cables

DESCRIPTION	FIG. NO.
320 AMP Thawing machine with cables	153805
CABLES ONLY	
20 FEET	9158
50 FEET	9159

QUICK SWEAT KIT For 1/2"-3/4"-1" Copper!



- Flexible 24" steel cables will slide through elbows and are interchangeable with the handle to fit different size copper.
- Durable polypropylene handle will fit 1/2" through 2" cables.
- Long lasting elastomeric plug
- Eliminates "bread" and outperforms all the rest.
- Kit includes: Handle & 1-Each 1/2", 3/4", 1" cables

FIG. NO.	PRICE
85052	

JETSWET

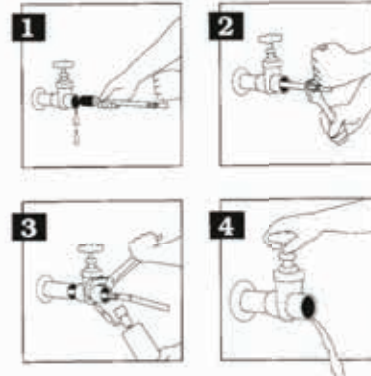

Allows dry soldering of support or cementing of plastic pipe with water in line. Used to repair pin-holes, replace elbows or replace valves.

SIZE	FIG. NO.	PRICE
1/2"	47508	
3/4"	47509	
1"	47510	
1 1/4"	47511	
1 1/2"	47512	
2"	47513	
2 1/2"	47514	
3"	47515	
4"	47516	

Set of 1/2", 3/4" & 1" with case

FIG. NO.	PRICE
47507	

Set of 1/2", 3/4", 1", 1 1/4", 1 1/2" & 2" with case

FIG. NO.	PRICE
47506	

**REPLACEMENT GASKETS
IN STOCK!**

DRAIN KING



1" TO 2" DRAINS
UNCLOGS:

- *Swimming Pools
- * Bathtubs and showers
- * Bathroom sink
- *Only model to work in bathroom sink

FIG. NO.	OEM NO.	PRICE
16289	501	



1 1/2" TO 3" DRAINS
UNCLOGS:

- *Kitchen sinks
- * Showers
- * Washing machine drains
- * Bathtubs

FIG. NO.	OEM NO.	PRICE
16287	186	



3" TO 6" DRAINS
UNCLOGS:

- *Main drains
- *Outside deck drains
- *Basement drains

FIG. NO.	OEM NO.	PRICE
16291	750	



6" TO 10" DRAINS
FOR COMMERCIAL USE

FIG. NO.	OEM NO.	PRICE
51071	6810	

DRAIN KING is made of durable rubber. It is extremely strong, and flexes under pressure with a powerful muscular action that forces jets of water through the surge valve and up to the blockage. Pulsations continue automatically until the obstruction is loosened and flushed through the drain—no harsh chemicals, no long waits.

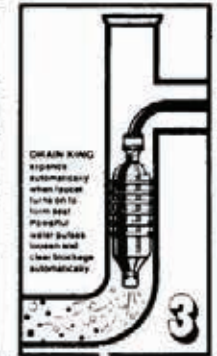

Cherne Test Ball Plugs and Accessories



CHERNE TEST-BALL PLUGS

SIZE	FIG. NO.	PRICE
1 1/2"	7570	
2"	7571	
3"	7573	
4"	7575	
5"	7577	
6"	7580	
8"	7582	
10"	7584	
12"	7586	

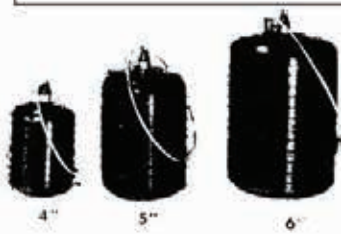
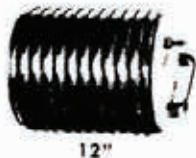
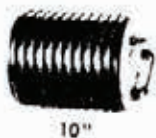

CHERNE PETCOCK ASSEMBLY

The petcock assembly helps retain full inflation pressure with 1 1/4" - 1 1/2", and 2" test ball plugs when the test pump is being disconnected.



FIG. NO.	PRICE
47216	



Extension Hose Assembly

The extension hose makes testing with the test-ball plug in longer reaches easier.

SIZE	FIG. NO.	PRICE
24"	7591	
36"	7595	
60"	7596	



CHERNE TEST PUMP WITH GAUGE

A heavy duty air pump designed for use with the Cherne Test-ball plug. The pump is complete with brass check valve, unbreakable pressure gauge and cast iron base. The 36" hose has a quick coupler disconnect device which allows for instant release from the test-ball plug.

FIG. NO.	PRICE
7589	

ELECTRIC SOLDERING TOOL



A compact portable soldering tool for copper fitting. Electrically operated, the power pack converts 115 AC line voltage to low voltage high amperage current. When two carbon electrodes in the gun tip contact the copper joint to be soldered, the heating begins. Clean and easy to use. Safe to use near wood or flammable material because there is no open flame. Handle stays cool. Light is on when ready for use. Makes 3/8" - 2" soldered joints.

Input	110/120 volts, 50/60 Cycles, 5
Output	Amps 5.2 volts, 275 Amps,
Output Cord Reach	15/750 Watts
Duty Cycle	10 Feet
Weight	50%

FLARE TOOL

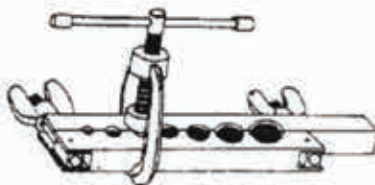

FLARESET

FIG. NO.	PRICE
44697	

FLARING TOOL

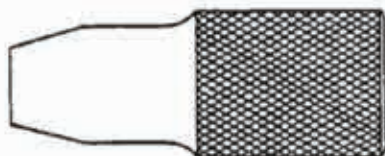

TORCH HOLDER



LIKE A THIRD HAND!
AIMS BURNER TIP AT THE WORK
LEAVING BOTH
OF YOUR HANDS FREE.



KEEPS TORCH UPRIGHT.
REDUCES CHANCE OF
ACCIDENT FROM TOPPLING
CYLINDER

TORCH HOLDER

FIG. NO.	PRICE
49324	

SWEDGING TOOL 3/8" TO 3/4" For copper tube



FIG. NO.	PRICE
12595	

SWEDGE TOOL For copper tube

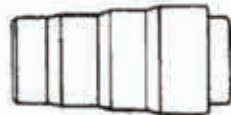

1 1/4", 1 3/8", 1 1/2"

FIG. NO.	PRICE
12593	

FLAMESHIELD



FIG. NO.	PRICE
36423	

COLD FIRE



RAPIDLY cools down heated surfaces

Helps to eliminate heat damage to valves and controls

Areas of use:

Boilers & Furnaces, Vanities,
Crawl Spaces, Under sinks

Environmentally friendly, non-corrosive,
biodegradable, non-staining, no messy cleanup

FIG. NO.	PRICE
82784	

COPPER BENDING SPRING



OD SIZE	FIG. NO.	PRICE
1/4	13613	
5/16	13614	
3/8	13615	
7/16	13616	
1/2	13617	
5/8	13618	
3/4	13619	
7/8	13620	

HAMMER FLARING TOOL

ID SIZE	FIG. NO.	PRICE	SIZE	FIG. NO.	PRICE	SIZE	FIG. NO.	PRICE
3/8	13605		3/4	13608		1 1/2	13611	
1/2	13606		1	13609		2	13612	
5/8	13607		1 1/4	13610				

TANKS

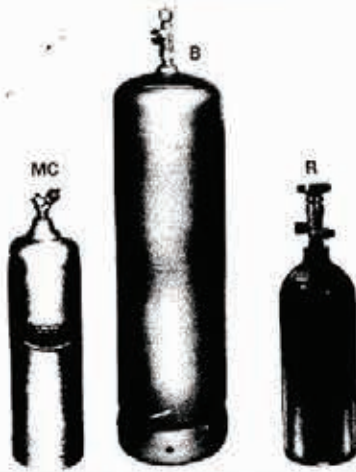

OUTRIGHT	
FIG. NO.	
B Tank	11084
MC Tank	11087
R Tank	11100
OXY Tank	11103

EXCHANGE	
FIG. NO.	
B Tank	11084X
MC Tank	11087X
R Tank	11100X
OXY Tank	11103X

Worthington/Lenox Tank Tote Sleeve



OEM No.	Type
331942	For B-Tank
331973	For MC Tank

GASES



Disposable Propane tank with tip.

FIG. NO.
11105



FIG. NO.	
Propane	11079
Mapp Gas	11080



Flint Lighter.
FIG. NO.
11074
Renewal Flints Only. (5 PACK)
FIG. NO.
11075



Acetylene Key.

FIG. NO.
42974

MC and B-Tank Carrying Stands



Heavy duty steel construction, storage for tips, hose, handle and striker

OEM No.	Type
TT-MC	MC Tank Carrier
TT-B	B-Tank Carrier



Surefire flame tip - Fully adjustable flame control. Instant ON-OFF trigger improves fuel savings and convenience. Durable, high-quality cast aluminum. Burns efficiently in any position.

FIG. NO.
18127



Pencil Flame Torch - All brass Construction; Operates efficiently on Mapp or Propane; Adjustable pencil point flame to large bush flame; Fits all disposable cylinders.

FIG. NO.
11107

B-Tank Tote

Convenient handle, composite construction, includes hose rack storage



Fig. No.
42968

AIR ACETYLENE KITS

ACETYLENE STARTER KIT



AIR-ACETYLENE STARTER KIT includes:

- * 440G 'B' cylinder regulator
- * 2AM Torch Handle
- * 3A Torch Tip
- * AH3 12.5 ft. 3/16" ID hose with 3/8" L.H. "A" fittings
- * Spark lighter

	FIG. NO.	PRICE
B KIT	42962	
MC KIT	42961	

CHROME PLATED TIPS

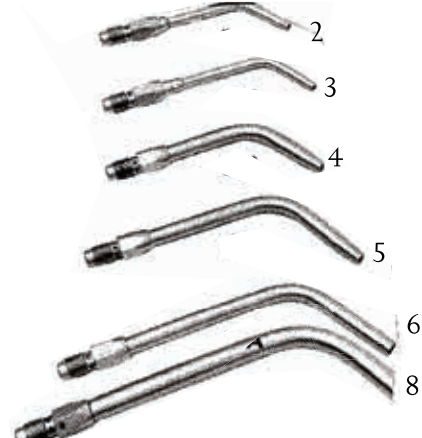

HOSES



Acetylene hose with spring-reinforced ends.
12 1/2 FT with 3/8" LH "A" fittings

DESCR	FIG. NO.	PRICE
12.5 FT with 3/8" LH "A" fittings	6588	
25 FT with 3/8" LH "A" fittings	6594	

FIG. NO.	PRICE
50779	

TORCH HANDLE



Handle with front control valve for one hand finger tip control.

FIG. NO.	PRICE
6612	

ACETYLENE REGULATOR



DESCR	FIG. NO.	PRICE
B Regulator Complete	6575	
MC Regulator complete	6582	
Acetylene Gauge Only	7055	

DUFF DIFFERS

ask us how!

DESCR	FIG. NO.	PRICE
TS-2 Very fine flame; wire soldering; jewelry, electronic and optical work.	60720	
TS-3 Fine flame; light refrigeration and control soldering work; auto radiator work.	42963	
TS-4 Flame suitable for soldering 3/8" to 3/4" copper tubing; cable connections; sheet metal work.	42964	
TS-5 Medium flame suitable for soldering 3/4" to 1 1/2" tubing; body and fender work.	42965	
TS-6 Heavy heating work; pipe thawing.	42966	
TS-8 Largest flame available to heat large areas.	72745	

CYLINDER TO REGULATOR ADAPTERS

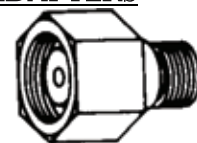
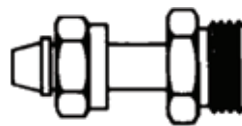

DESCR	FIG. NO.	PRICE	DESCR	FIG. NO.	PRICE
MC TO B	42981		B TO MC	7052	

TURBO TORCH ACETYLENE SYSTEM



X-5 Starter Kit - soft solders to 1 1/2". Silver solders to 7/8". For the person who want a kit to which he can add tips for his application and needs. Kit includes: regulator, hose, quick disconnect handle, 6530 tip and heat shield.

FIG. NO.	PRICE
6496	



X-3 Starter Kit - soft solders to 1 1/2". Silver solders to 7/8". For the person who want a kit to which he can add tips for his application and needs. Kit includes: regulator, hose, quick disconnect handle, 6530 tip and heat shield.

FIG. NO.	PRICE
6441	



X-4 Kit - For tough silver brazing and bronze brazing jobs in air conditioning and refrigeration. Soft solders 3/4" to 4". Silver brazes 3/8" to 4". Includes A5 and A14 tips, pre-set regulator, handle and hose.

FIG. NO.	PRICE
6449	

CUSTOMERS COME FIRST!

HANDY HAND



This tool is ideal for retrieving small objects trapped in basins, sewer drains, etc. It is also helpful for starting bolts, nuts and screws in hard to get at spots.

FIG. NO.	PRICE
17481	

DUFF differs

ACETYLENE TIPS



SOFT SOLDERING WITH TURBO TORCH-ACETYLENE

TUBING SIZE	FIG. NO.	PRICE
1/4" to 1 1/2"	6509	
1/4" to 1"	6521	
3/4" to 1 1/2"	6530	
1" to 2"	6540	
1 1/2" to 3"	6546	
2" to 4"	6553	
Over 3"	6563	

SILVER SOLDERING WITH TURBO TORCH-ACETYLENE

TUBING SIZE	FIG. NO.	PRICE
1/8" to 3/4"	6509	
1/8 to 3/8"	6521	
3/8" to 7/8"	6530	
5/8" to 1 1/8"	6540	
7/8" to 1 5/8"	6546	
1 1/8" to 2 1/8"	6553	
1 5/8" to 4 1/8"	6563	



Pressure Regulator - Durable, accurate, easy to use. Modern, compact design protects regulators, gauge and hose from breakage even if tank falls over. Made for B and MC tanks. Fixed pressure and adjustable models.

FIG. NO.	PRICE
B	6575
MC	6582



Snappy Adapter

Snappy Adapter - Screws into your prestolite or other handle adapting it to Turbo Torch tips. Provides the advantages of Turbo Torch at lowest cost.

FIG. NO.	PRICE
6616	



3/16" ID HOSE.

PROPANE HOSE

FIG. NO.	PRICE
12'	7027
24'	7029

ACETYLENE HOSE

FIG. NO.	PRICE
12'	6588
24'	6594



Handle - features exclusive "quick disconnect". Snap in the right tip...change to another in seconds...never a need to use wrong size tip.

FIG. NO.	PRICE
6612	

For additional information call: 610-275-4453 or Fax: 610-279-6299
Please call for current prices.

TURBO TORCH, AIR/LP UNITS/ACCESSORIES



STK-9 Kit - for the professional. 360 degree swivel tips for easy, a rugged brass regulator, and easy to clean orifice. Lets you choose the gas for silver soldering copper tubing, bronze brazing steel pipe, or solder with water in the line. Includes pressure regulator, Tip, Mapp Tank and striker in rugged plastic box.

FIG. NO.	PRICE
7035	

LP TIPS



COPPER TUBING SIZE CAPACITY - PROPANE GAS

SOFT SOLDER	SILVER SOLDER	FIGURE NO.	PRICE
1/8 - 1/4	1 1/16 - 1/4	6674	
1/4 - 1	1/8 - 1/2	6694	
1/4 - 1 1/2	1/4 - 3/4	6699	
1 1/2 - 2 1/2	1/2 - 1 1/4	6706	
1 1/2 - 4	3/4 - 2	6710	

COPPER TUBING SIZE CAPACITY - MAPP GAS

SOFT SOLDER	SILVER SOLDER	FIGURE NO.	PRICE
1/8 - 1/2	1/8 - 1/4	6674	
1/4 - 1 1/2	1/4 - 1/2	6694	
1/4 - 2 1/2	1/4 - 1 1/4	6699	
1 - 4	1/2 - 2	6706	
1 1/2 - 6	3/4 - 4	6710	

TOTAL LP HOSE



3/16" ID LP hose with 9/16" 18 LH thread. For Propane

SIZE	FIG. NO.
12 FT	7027
24 FT	7029



LP Kit - Soft solders to 2 1/2". Silver brazes to 1 1/4". Includes: Adjustable regulator, handle, hose, tip and striker.

FIG. NO.	PRICE
6643	



DESCRIPTION	FIG. NO.	PRICE
Silverflow - substitute for 6% - 15% silver content brazing alloys. For copper tubing installations, large and small. Self fluxing on copper.	7045	
Bronzeflow - Bronze brazing. Low fuming, flux control. Ideal for joining steel to steel or steel to copper in new or repair work.	7040	

**DUFF IS ALWAYS
ON CALL
365 DAYS A YEAR
24 HOUR EMERGENCY SERVICE!**

BRUSHES



ACID BRUSH

	FIG. NO.	PRICE
EACH	16400	
BOX OF 144	67042	



FITTING BRUSH

SIZE	FIG. NO.	PRICE
1/4	16253	
3/8	16259	
1/2	16260	
5/8	16261	
3/4	16264	
7/8	16267	
1	16271	
1 1/4	16273	
1 1/2	16277	
2	16280	

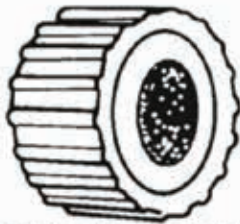

COPPER TUBE BRUSH

SIZE	FIG. NO.	PRICE
1/8	16284	
1/4	16286	
3/8	16300	
1/2	16302	
3/4	16305	

Utility Brush



5/8 x 1 5/8 x 29

FIG. NO.	PRICE
50305	

COPPER FITTING TOOLS

6-IN-1 TOOL

FIG. NO.	PRICE
16402	



**CALL DUFF FIRST
FOR ALL YOUR TOOL
NEEDS!**

6-IN-1 TOOL REPAIR KIT



FIG. NO.	PRICE
37983	

GREEN/YELLOW
SCRUBBY SPONGE



FIG. NO.	TYPE
237819	5-Pack

ABRASIVE PADS
4" X 6"



FIG. NO.	TYPE
66058	Each
237844	Sleeve

STEEL WOOL



STEEL WOOL

TYPE	FIG. NO.
SLEEVE	66912
SLEEVE with embedded soap	1624718

OPEN GRIT

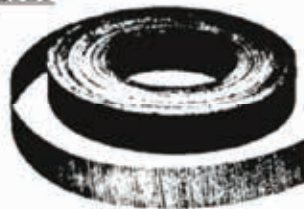

PERMANENT SAND CLOTH

SIZE	FIG. NO.	PRICE
1 1/2 X 25'	16398	
1 1/2 X 10'	43188	



PLUMBER'S SAND CLOTH

SIZE	FIG. NO.	PRICE
1 1/2 X 10'	16395	
1 1/2 X 25'	16393	

SCRATCH BRUSHES

BENT HANDLE SCRATCH BRUSH
4 X 18 ROWS



Best quality. Solid Appalachian hard wood handles and backs - tough, quality, oil tempered, carbon steel fill wire.

FIG. NO.	PRICE
16410	

STRAIGHT BACK SCRATCH BRUSH
6 X 19 ROWS



Best quality. Solid Appalachian hard wood handles and backs - tough, quality, oil tempered, carbon steel fill wire.

FIG. NO.	PRICE
16413	

FINE WIRE HAND SCRATCH BRUSH
3 X 7 ROWS



Plastic handle. Brass bristles.

FIG. NO.	PRICE
58034	

NYLON TUBE BRUSH
1/2" diameter X 30"

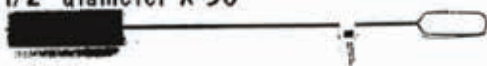

For cleaning boilers, burners, radiators, flues, vents and nozzles! Also GREAT for cleaning gauge glass!

FIG. NO.	PRICE
63946	

DOPE BRUSH

Acid, Solder paste & flux, adhesive applicator brushes



FIG. NO.	PRICE
16406	

ECON PAINT BRUSH



FIG. NO.	PRICE
316294	

24
EMERGENCY
SERVICE
Another
way DUFF
Differs.

CONDENSER TUBE & HEAT EXCHANGER BRUSHES



All brushes have an 11/32" diameter coupling with a 5/16-18 internal thread and 1/8" NPT outside.

There is no O.D. thread on 3/8" brushes. Brush lengths are 4 1/2", 7 1/2" overall length.

SIZE	FIG. NO.	PRICE
3/8	16334	
7/16	16337	
1/2	16343	
9/16	16345	
5/8	16348	
11/16	16351	
3/4	16355	
13/16	16358	
7/8	16360	
15/16	16363	
1	16366	
1 1/8	16368	
1 1/4	16372	
1 3/8	16373	
1 1/2	16375	
1 5/8	16377	
1 3/4	16379	
1 7/8	16381	
2	16383	
2 1/4	16384	
2 1/2	16386	
2 3/4	16389	
3	16391	

CONDENSER TUBE BRUSH EXTENSION HANDLES



SIZE	FIG. NO.	PRICE
36" Handle w/ male thread	16328	
24" ext-male one end, female on the other	16331	

FLUE & BOILER TUBE BRUSHES



Quality flue and boiler brushes. Engineered from durable black oil-temperd wire. All brushes have an overall length of 8" and brush length of 4 1/2" All brushes are 1/4" NPT Male.

FIG. NO.	BRUSH DIAMETER	FLUE DIAMETER	PRICE
52361	1 1/4"	1 1/2"	
52362	1 1/2"	1 3/4"	
85746	1 3/4"	2"	
85748	2"	2 1/4"	
85749	2 1/4"	2 1/2"	
85750	2 1/2"	2 3/4"	
52363	2 3/4"	3"	
44927	3"	3 1/4"	
44922	3 1/4"	3 1/2"	
44923	3 1/2"	3 3/4"	
44924	3 3/4"	4"	
52360	4"	4 1/4"	

CHIMNEY BRUSHES



Standard Round Wire Brush

FIG. NO.	DESCRIPTION	PRICE
16307	5" round	
16310	6" round	
16312	8" round	
16314	9" round	
16318	10" round	
16321	11" round	
16323	12" round	
16326	14" round	

ALSO AVAILABLE!

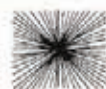

Standard Square Wire Brush

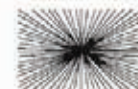

Standard Rectangular Wire Brush

PACKING HOOKS

Packing hooks are time and labor saving tools for removing packings from stuffing boxes. Sturdy and reliable packing pullers that can be used effectively around obstructions and in hard to get at areas. The corkscrew bits, which are securely attached to the flexible steel cable shaft, are made of specially tempered tool steel. Packing hooks are available in six convenient sizes to meet all requirements.



HOOK #	BIT DIAM	OVERALL LENGTH	USED FOR PACKING SIZES	FIG. NO.	PRICE
KIT (1,2,3)					
1	7/32"	7 1/2"	1/4-5/16"	17495	
2	5/16"	11"	3/8"	17496	
3	3/8"	15"	7/16-1/2"	17497	
4	1/2"	19"	9/16-5/8"	17499	
5	5/8"	22"	11/16-1"	17500	



O-ring making kit - Contains all the materials and tools you need to produce stationary o-rings on the spot. You don't need to stock an extensive inventory or endure long waits for delivery of special sizes. Make any size you need in 60 seconds or less - and you can make it right at the machine. Contains: Buna-N V cord - 3 foot lengths of four frequently needed diameters - 3/32", 1/8", 3/16", and 1/4"; Oring splicing fixture - works with various diameter sizes - includes metric scale; Cutter - right in the kit to assure the right length; Permatex pen - for fast, sure high strength bonding.

CENTER-O-PUNCH

Tools for quick accurate on the job cutting of washers and gaskets. Receding pointed plunger marks the dead center. Material is automatically ejected with each punch. There is no more clogging of dies with resulting loss of time and efficiency. Cutter sizes are 1/4", 5/15", 3/8", 7/16", 1/2", 5/8, 3/4", 7/8", 1". Dies are quickly and easily interchanged. Standard set consists of handle (with spring and plunger assembly) and 9 cutter sizes indicated above, in sturdy steel box.



SIZE	FIG. NO.	PRICE
STD	17503	
JUMBO	17504	

ORING PICK KIT - 5 piece set has straight, 90 deg angle point, double bend point, and hook point. Aluminum handle accepts point quickly and easily with highest scribe. As a small awl, as a hook to pull small springs, a pick up to remove o-rings, boots and gaskets.

FIG. NO.	PRICE
50419	

ORING PICK - individual

FIG. NO.	PRICE
50417	



FIG. NO.	PRICE
16208	

GASKET CUTTER



FIG. NO.	PRICE
EACH	49301
BLADE KIT	45183
BOARD	17476
SET	17475

GASKET CUTTER BOARD



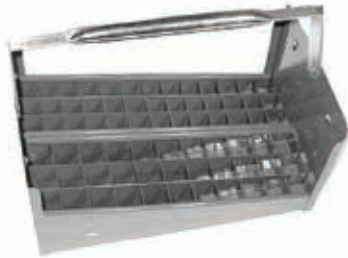

COMBO NIPPLE BOX

- Holds both 1/2" and 3/4" nipples
 - Holds 39 1/2" - CL thru 6"
 - Hold 33 3/4" - CL thru 6"
 - Fold away handle
- SORTS SIZES EASILY!**

FIG. NO.	PRICE
51243	

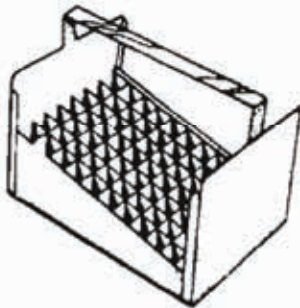

NIPPLE BOX

- Enameled Steel
- Holds 77 1/2" nipples
 - Holds 66 3/4" nipples
- SORTS SIZES EASILY!**

	FIG. NO.	PRICE
1/2"	51241	
3/4"	51242	

IGNITOR TOOL

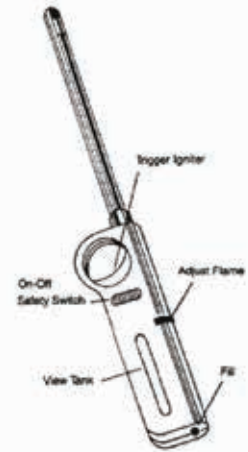

Hand held extended lighter for relighting pilots in hard to reach places.

FIG. NO.	PRICE
43519	

FLANGE SPREADER

Part No.	Description	Spread	Pin Diameter	150 lb	300 lb	400 lb	600 lb	900 lb	1,500 lb
784003	ST-301 Flange Spreader	3" (76 mm)	5/8" (16 mm)	1 - 6"	0.75 - 4"	0.5 - 2"	-	-	-

Spreads all types of flanged pipe connections to insert blinds-gaskets-orifices. Save time and eliminate hazard of spreading flanges. No hammer blows, no chisels, no flying wedges and no sparks.

FIG. NO.
83003



DUFF SELLS SOLUTIONS



Let us help find yours.
610-275-4453



ADJUSTABLE SPUD WRENCH

FIG. NO.	PRICE
64606	



CLOSET SPUD WRENCH

FIG. NO.	PRICE
48666	



STUVELL FLUSH VALVE RESEATER TOOL

FIG. NO.	PRICE
17478	



The **CLOSET SEAT NUT WRENCH** is a small, completely enclosed, rigid jaw wrench for turning various closet seat nuts on the elongated bolt used in securing closet seats to water closets. The wrench has an axial bore for the bolt shank, regardless of the length of the shank. The wrench is constructed to engage or disengage the nuts without danger of fracturing non-metallic nuts. The awkward task of tightening or loosening nuts is made easy since BOTH ENDS of the tool are adapted for use with a leverage pin, wrench, or ratchet wrench.



CLOSET SEAT NUT WRENCH

FIG. NO.	PRICE
17486	

WATER RAM

Opens Clogged Pipes with SHOCK ACTION

A burst of kinetic energy moves suddenly and swiftly ... sending a force of 4300 psi to clear stoppages in lines up to 4" dia. Effective around elbows and numerous bends. Bypasses vents. 98% of force hits stoppage, only 2% reaches pipe walls.

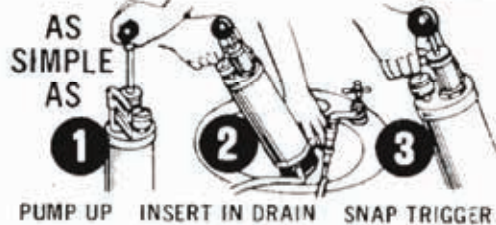

PUMP UP INSERT IN DRAIN SNAP TRIGGER

Send for details on General's clean, quick-acting Water Ram.

DESCR	FIG. NO.
Kinetic Water Ram, complete with water supply hose, universal faucet adapter, stainless steel clamp, 3-ply caulking hose, 4" tapered rubber cone, five tapered rubber plugs, plus metal carrying case	15774
Same as above with 6" tapered rubber cone and 1 1/2", 2", 3" and 4" expansion plugs.	20577
Repair Kit	38072



DUFF DELIVERS





WASHER TRIMMER - A practical tool designed to cut bibb washers to proper size, thereby insuring a perfectly fitting washer. Made of aluminum - precision machined. Cutting blade of tempered swedish steel. Takes washers from 5/8" diameter to No. 00. A QUALITY tool that every plumber should own!

FIG. NO.	PRICE
17482	

HANDLE PULLER
Removes frozen handles quickly and easily.

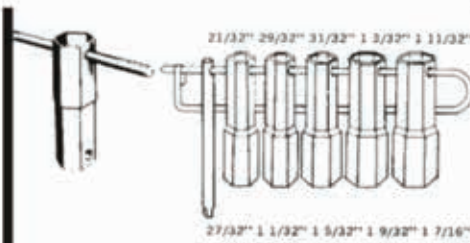

FIG. NO.	TYPE
51590	2-Prong
110546	3-Prong



GARBAGE DISPOSER TOOL - frees jammed disposals. Bottom lever of tool tilts to allow easy entrance or exit. Place firmly on bottom inside disposer, turn right and left. Remove tool and turn on disposer switch.

FIG. NO.	PRICE
38889	



SHOWER VALVE DEEP SOCKET WRENCH SET

FIG. NO.	PRICE
16220	

IMPACT HANDLE PULLER



FIG. NO.	PRICE
110549	

GAS LEAK DETECTOR



FIG. NO.	PRICE
318322	

11" BASIN WRENCH

SIZE	FIG. NO.	PRICE
11"	44698	



CONE BIBB REAMER - extra long handle for use on shower fixtures, valves and bibbs. Reforms worn, corroded faucet seats with a curved contour like new. Easy and fast to use on all styles and kinds of faucets, globe and stop waste valves.

FIG. NO.	PRICE
17469	

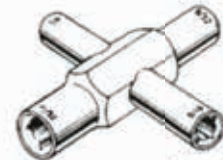

4-WAY SILLCOCK KEY - fits popular make stop cocks with stems 1/4", 9/32", 5/6" and 11/32".

FIG. NO.	PRICE
17491	

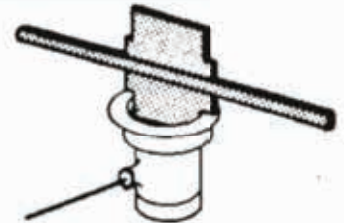

LEVER WASTE INSTALLATION TOOL - for removal or installation of wastes 3" or 3 1/2" openings. Heavy duty stainless steel construction.

FIG. NO.	PRICE
38843	



MISCELLANEOUS PLUMBERS' TOOLS

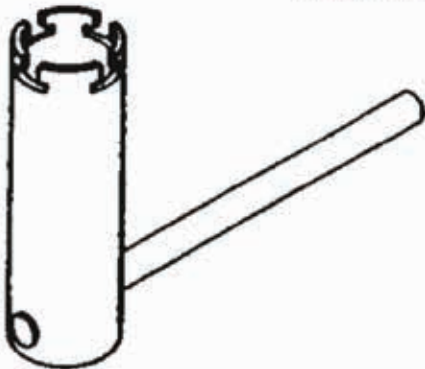

Strainer Wrench - For installing kitchen basket strainers and tub drains with cross bars. Plated steel. Long handle for leverage.

FIG. NO.	PRICE
49833	

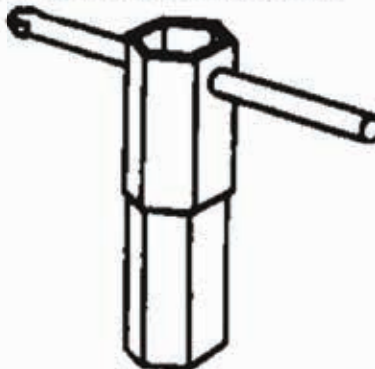

Water Heater Element Socket - Aids in the removal of all brands of water heater elements.

FIG. NO.	PRICE
8718	



Moen Cartridge Puller - Remove MOEN faucet cartridges with ease.

FIG. NO.	PRICE
17477	

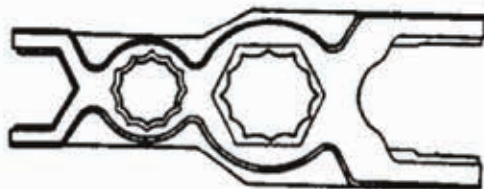

SLOAN FIT ALL SUPER WRENCH

FIG. NO.	PRICE
41550	

FITS ALL SLOAN NUTS AND COUPLINGS!

24 Hour Service.
Another way
DUFF
DIFFERS



THE SMART DUMBELL

Fits 95% of all tub drains
Fits 1 1/2" and 2" closet spuds
Installs or removes lift and turn drains with posts
Prevents scratching

FIG. NO.	PRICE
58658	

"QUICK NUTCRACKER"

PATENT NUMBER 4,366,413

Quickly removes corroded 1/2" zinc locknuts from faucet shanks.

- Heat treated cutter blades
- Ball thrust bearings
- Durable black oxide finish
- Will work on faucet shanks with only three threads showing



FIG. NO.	PRICE
17752	

DIRECTIONS FOR USE

1. Remove water supply tubing, slip joint nut and cone washer from faucet shank.
2. Screw the "QUICK NUTCRACKER" onto the faucet shank.
3. Using a 3/8" ratchet and ratchet extension, drive the tool up on the shank until it engages the nut. Keep tightening and the blades will start cutting through the nut.
4. Check progress of the cutter to make sure it is cutting through the nut.
5. The Nutcracker cuts through the two sides of the nut at different times. Two "pops" will be heard. The first "pop" is one side of the nut splitting and the second "pop" is the other side splitting.
6. The nut halves should now fall off or can be removed.
7. Repeat process with the other shank.
8. Faucet may have to be jiggled to release the broken nut halves.

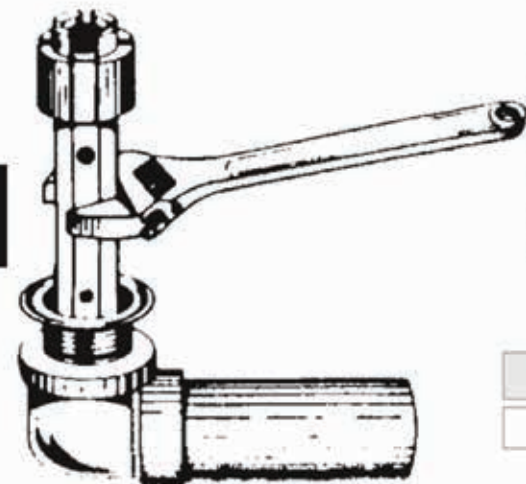

PLUMBING TOOLS



BIBB SEAT REMOVER KIT - Set includes: 1 ea. 3/8" x 7/16" ratcheting box wrench, 1 ea small hex/large hex tapered bibb seat tool, 1 ea small square/large square tapered bibb seat tool, 1 ea small square/large square no taper bibb seat tool.

FIG. NO.	PRICE
12512	



GERBER SEAT WRENCH

FIG. NO.	PRICE
72714	

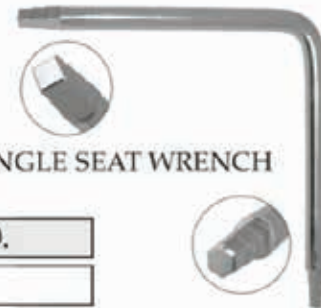

WAL-RICH ANGLE SEAT WRENCH

OEM NO.
1818128

HEXAGON SEAT REMOVER
Step Ends

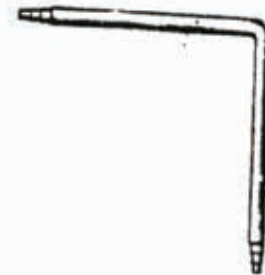

FIG. NO.	PRICE
12543	

DUFF has the best selection of plumbing tools! Call us today for all the tools you need.



BASIN FORK WRENCH

FIG. NO.
57413

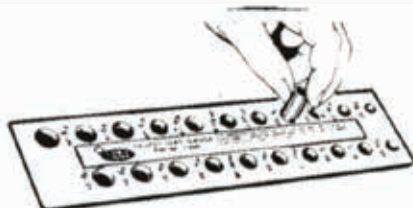

FAUCET SEAT GAUGE - for quick, easy identification of faucet seat threads. 21 drilled and tapped set sizes. Heavy aluminum. thread sizes clearly marked. Threads are identical to OEM threads.

FIG. NO.	PRICE
17488	

CAULKING TOOLS

COLD CHISEL

Designed for cutting cast iron or steel* Made in USA



SIZE	FIG. NO.	PRICE
3/4" x 7"	12409	
1" x 8"	44737	
3/4" x 12"	19486	

Seems like
a good time
to check and
stock up on
Caulking Tools



PACKING OR YARNING TOOLS

SIZE	FIG. NO.	PRICE
5/8" x 12"	12445	



SHORT NOSE PACKING TOOLS

For finishing lead joint

SIZE	FIG. NO.	PRICE
5/8" x 7 1/2"	12450	



INSIDE CAULKING TOOL

For finishing lead joint

SIZE	FIG. NO.	PRICE
5/8" x 7"	12472	



OUTSIDE CAULKING TOOLS

For finishing lead joint

SIZE	FIG. NO.	PRICE
5/8" x 7"	20762	



BROAD CURVE NOSE CAULKING TOOLS

Used for packing oakum tight
For first pass on lead

SIZE	FIG. NO.	PRICE
5/8" x 8" x 1 1/2"	12483	



LEAD POT

SIZE	FIG. NO.	PRICE
6"	7439	



CAST IRON LADLE

SIZE	FIG. NO.	PRICE
3"	7388	



WING NUT TEST PLUG

SIZE	FIG. NO.	PRICE
2	7431	
3	7432	
4	7433	
5	7434	
6	7435	
8	7436	
10	41558	



PLUMBERS LEAD MELTING FURNACE LESS TANK

OEM NO.
PASCO 4597



"I" AND "K" PROPANE CYLINDER TANKS

BBQ (I)

FIG. NO.	PRICE
11090	

FURNACE (K)

FIG. NO.	PRICE
11096	



MARQ II



MARQ II TEST CAP

Comes complete with long lasting corrosion resistant gear type clamp for easy tightening with screwdriver or no hub wrench. Fits cast iron pipe, plastic pipe or copper tubing. IAPMO approved for test out and permanent cap-off for drain pipes, waste pipes, and vent pipes (DWV).

SIZE	FIG. NO.	PRICE
1 1/2	7603	
2	7604	
3	7605	
4	7606	



MARQ II TEST PLUG

A tough test plug tailored to do the job. Made of the finest cold roll steel and neoprene rubber. The only one of it's kind with the unique flange design.

SIZE	FIG. NO.	PRICE
1	7597	
1 1/4	7598	
1 1/2	7599	
2	7600	
3	7601	
4	7602	
5	173188	
6	52576	



ELECTRIC LEAD MELTING POT

SIZE	FIG. NO.	PRICE
25 LB.	38829	
50 LB.	38830	



JOINT RUNNER

SIZE	FIG. NO.	PRICE
4"-6"	12620	
6"-8"	12621	

ZIP IN



ALL IN 1/4" HEAD SIZE

SIZE	FIG. NO.	PRICE
7X112	16178	
8X12	16179	
8X34	16181	
8X1	16182	
8X112	16183	
10X12	16186	

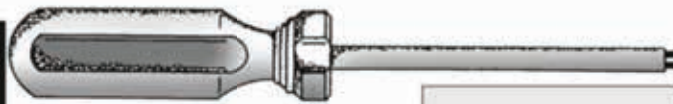

One way screw removal tool.
Great for toilet partitions.

	FIG. NO.	PRICE
for #6-8 screws	44045	
for #8-10 screws	43910	
for #12-14 screws	43911	

MAGNETIC DRILL CHUCKS

Magnetic drill chuck for hex head screws.



SIZE	FIG. NO.	PRICE
1/4"	16192	
3/8"	16194	
5/16"	16193	

NUT SPLITTING TOOL



Nut splitting tool. For use in removing rusted and corroded nuts. Forged Steel. Offset for easy use.

FIG. NO.	PRICE
17752	



Since 1947, DUFF Co. has been your source when you need it now ... or don't know how.

Plumbing and heating supplies, pumps, water conditioning equipment and systems, and multifamily housing supplies - DUFF Co. is now your one-stop source.

FAX US YOUR ORDER!

610-279-6299



CURB BOX WRENCH

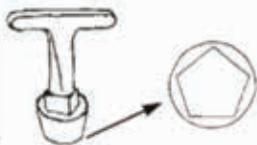

Curb box wrench - for the 5 sided pentagon curb box nuts. Thin wall sockets fit all make boxes.

FIG. NO.	PRICE
12523	

HEX KEY SET

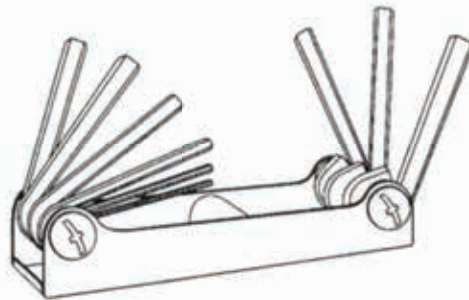

Eliminates looking for the right hex key. All keys fold like a knife into one convenient handle. Snaps into work position for leverage - use at any angle. Keys made of best quality chrome nickel alloy steel. Scientifically hardened for maximum strength. Handle Length - 3"

FIG. NO.	PRICE
.050 - 3/6	16150
5/640 - 1/4	16152

SCREWDRIVER SET



7 IN 1. New combination tool with seven screw driver blades in one complete unit which folds like a pocket knife. All blades made from high quality steel, hardened and tempered. Each blade can be used straight out or at right angles for extra leverage.

FIG. NO.	PRICE
50681	

WAL-RICH 8-PIECE T-HANDLE HEX KEY SET

OEM NO.
1818137



INTERNAL SPUD WRENCH
A must to install or remove urinal and closet spuds, waste and overflows. 4" capacity, cushioned grip.

FIG. NO. PRICE
83501



PLUMB BOB
5 Oz.

FIG. NO. PRICE
42516



THREAD GAUGE
Measures and identifies 18 different thread sizes, seats, etc.

FIG. NO. PRICE
17483



CAULKING GUN - Ratchet type.

FIG. NO. PRICE
12648



BLUE POLY TARP - 10 times stronger than canvas yet 1/3 lighter! Reinforced corners, grommets every 3'.

SIZE	FIG. NO.	PRICE
10x12	64237	
12x20	64238	



HOLD-ZIT - rubber straps and fasteners. Long-life, weather resistant rubber for tucks, trailers, cars, to hold down tarps and equipment.

SIZE	FIG. NO.	PRICE
15"	16204	
22"	16205	
31"	16206	



NO HUB TORQUE WRENCH

FIG. NO.	PRICE
13134	

SEE PAGE 740 FOR RIDGID TORQUE WRENCHES

PLUNGERS

HYDRO THRUST FORCE CUP



FIG. NO.
14627

SMALL HAND PLUNGER



FIG. NO.
219222

HEAVY DUTY RED FORCE CUP



4" (9" handle)
FIG. NO.
14628

KORKY MAX PERFORMANCE PLUNGER

- Fits both old and new High Efficiency Toilets (HET)

- Excellent replacement for "Bulldog" plunger



FIG. NO.
342004

PLUNGER DISCS ONLY



3/8" Fiber reinforced rubber discs for drainage plungers.

SIZE	FIG. NO.
2"	12615
3"	12616
4"	12617
6"	205331

COMPLETE DRAINAGE PLUNGERS



Reinforced rubber discs, with cast bronze holder, assembled.

SIZE	FIG. NO.
2"	12611
3"	12612
4"	12614

ZIP-IT DRAIN CLEANING TOOL



FIG. NO.
260023

DUFF DELIVERS



For additional information call: 610-275-4453 or Fax: 610-279-6299
Please call for current prices.

MISCELLANEOUS SAFETY TOOLS



THICKSTER Extra large
Nitrile Gloves - box of 50

FIG. NO.

308223



FIG. NO. REG THICKNESS

328179	Medium
237822	Large
237820	XL

IMPACT® IND. THICKNESS

334786	Medium
334787	Large
335857	XL



CAUTION TAPE (USA)
Bright yellow printed CAUTION.
Non pressure sensitive OSHA
yellow. 3" x 300'

FIG. NO.

44078



SUPER THERM LATEX DRIP-GRIPPER GLOVES - one size

FIG. NO. TYPE

325447	Premium (Pair)
328598	Econ (12 Pair)



SAFETY LIME WATERPROOF WINTER GLOVES

FIG. NO. SIZE

327455	Large
328598	XL



LEATHER UNLINED DRIVING GLOVES

FIG. NO. TYPE

86121	RIDGID
268589	Economy



WORKFORCE IRONCLAD GLOVES

FIG. NO.

172046



BROWN WORK GLOVES - Button jersey knit wrist, clute cut - one size fits all

FIG. NO.

20297



LEATHER PALM GLOVES - Perfect for tougher jobs — There are no seams in the palm "wear area"

FIG. NO.

20297



INDUSTRIAL RUBBER WORK GLOVES
Men's black, extra heavy, rolled cuffs. One size fits all

FIG. NO.

50701



DISPOSABLE DUST MASK
Protects against pollen, dust and paint spray. Use in shop, home, farm, etc.

FIG. NO.

45185

PLASTIC BUCKET - Ideal for draining traps, lavatories, sinks, etc. Available in 2 sizes with hammer on lid.



FIG. NO. SIZE

44867	3.5 Gallon
49386	5.0 Gallon

PROFESSIONAL PLIERS

Tools for the Professional **New!**



Tongue & Groove Pliers

Designed with Tool Professionals to meet the demands of the most intense applications in the field. RIDGID's new pliers and linesmen tools are made in the U.S.A. and precision crafted and engineered for long service life and ease of use. The cutting edges and teeth are sharpened using a special process to ensure longer usable life. See why RIDGID designs tools for the most demanding of users.

Benefits:

- Professional quality tools, forged and heat treated for high strength and durability.
- Precision crafted and designed to assure exacting performance and extended life.
- Slip Joint and Tongue & Groove pliers feature a flush rivet design which provides a stronger tool and allows access to tighter areas.
- New 10 1/2" Tongue & Groove pliers has v-notch profile for added gripping, and 8 adjustment arcs for extra capacity



General Purpose Pliers

Catalog No.	Model No.	Description	Length		Weight		Std. Pack
			in.	mm.	lbs.	kg	
16458	767	8" Slip Joint Pliers	8	203	1/2	0,2	2
16483	761	7" Wide Jaw Pliers	7	175	1/2	0,2	2
16488	766	8" Long Nose Cutting Pliers	8	203	1/2	0,2	2
16493	763	9 1/2" Linesman Pliers	9 1/2	241	1	0,5	2
62347	707	7 1/2" Tongue & Groove Pliers	7 1/2	191	1/2	0,2	2
62352	709	9 1/2" Tongue & Groove Pliers	9 1/2	241	1	0,5	2
16468	710	10 1/2" Tongue & Groove Pliers	10	254	1 1/2	0,7	2
16473	713	13" Tongue & Groove Pliers	13	330	1 1/2	0,7	2
62362	716	16" Tongue & Groove Pliers	16	406	2 1/4	1,2	1
18628	710	10 1/2" Tongue & Groove Display	10 1/2	254	1 1/2	0,7	20

RIDGID



And what, exactly, are pliers used for?

Pliers are generally used to round off bolt heads.
And sometimes they are used in the creation of blood-blisters.



PLIERS

**SMOOTH JAW FOR
CHROME NUTS**



TONGUE AND GROOVE PLEIRS. Smooth jaw 10" length, 7 adjustments 2" capacity. Dipped handles. Carded.

FIG. NO.	PRICE
50375	



STRAIGHT JAW TONGUE AND GROOVE PLEIRS. Standard design 9 1/2" length, 5 adjustments 1 1/2" capacity. Dipped handles. Carded.

FIG. NO.	PRICE
67718	



CURVED JAW TONGUE AND GROOVE PLEIRS. Curved jaw 9 1/2" length, 5 adjustments 1 1/2" capacity. Dipped handles. Carded.

FIG. NO.	PRICE
40718	



STRAIGHT JAW TONGUE AND GROOVE PLEIRS. Standard design 10" length, 7 adjustments, 2" capacity. Dipped Handles. Carded.

FIG. NO.	PRICE
67632	



CURVED JAW TONGUE AND GROOVE PLEIRS. Curved jaw 12" length, 7 adjustments 2 1/4" capacity. Dipped handles. Carded.

FIG. NO.	PRICE
40719	



Lightweight, rugged chrome-vanadium steel forging. Patented parallel jaw design insuring non-slip grip on round, hexagonal and square work. Operates with one-handed, downward pressure without squeezing. Cast stop prevents pinched fingers and blood blisters. Positive non-slip, easily adjustable, 11-position construction. PVC plastic coated handles for soft, sure grip.

SIZE	FIG. NO.
10"	54323
12"	54324
16"	80834

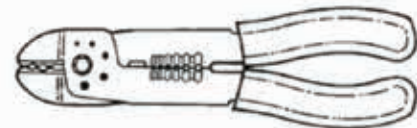

WIRE STRIPPER

FIG. NO.	PRICE
----------	-------

36468	
-------	--

NO-PINCH PIPE WRENCH PLEIERS



JONES STEVENS

173269	
--------	--

SNIPS AND CRIMPERS

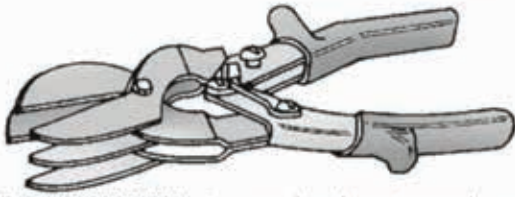

DESCRIPTION	FIG. NO.
5 - BLADE	16129

5 BLADE CRIMPERS - For easy hand motion and greater control; a superior compound leverage mechanism offers maximum ease of operation, and assures that manual crimps remain accurate over many repetitions. Comfortable opening, spring actuated handles, vinyl cushioned grips, and carefully placed hand stops combine to give you even more comfort and control. Wear resistant hardened steel construction features heavy duty linkage between handles and jaws, plus a closing stop, to maintain the same crimp profile over the file of the tool. Hardened steel also produces greater handle strength to stand up to abusive and resist collapsing. **3 BLADE CRIMPERS** - ideal for crimping heavy 22 and 24 gauge sheet metal. Nickel plated, all steel construction with red vinyl cushion grips. **SINGLE CRIMPER** - fast, easy to use and lightweight. Handy lock makes tool pocket sized. Zinc plated steel. Red grips.

FORGED STEEL SNIPS - Available in *regular pattern* - for straight cutting and wide curves; and *duckbill snips* - maneuvers and cuts easily to very tip of blade. Cuts sheet metal, aluminum and steel siding, plastics and other thin materials without tearing or catching.

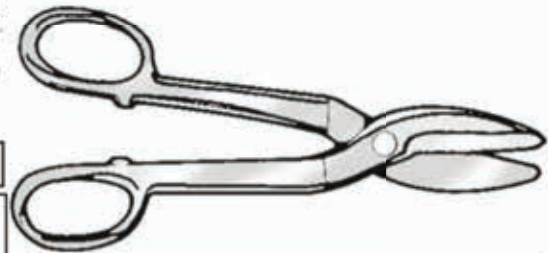

DESCRIPTION	FIG. NO.	PRICE
CIRCULAR DUCKBILL	16213	

AVIATION SNIPS - hot drop forged from high carbon alloy steel and fully heat treated for a hard and durable edge. Forged jaws offer superior strength and resistance to fatigue and fracture. The precision ground cutting edges of their jaws hold their sharpness longer and will not slip, even when cutting tight patterns in heavy stock. Machined serrations on the outside face of both cutting edges provide a positive grip on material for a smooth, accurate cut.

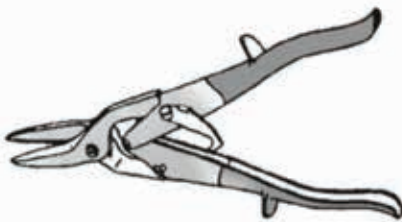

DESCRIPTION	FIG. NO.	PRICE
LEFT HAND	16143	
RIGHT HAND	16145	

HI, DUFF,
I'M ON
THIS JOB
AND
I NEED
A



Glad you
called.
YES — it
looks like
we have
it in stock



DOUBLE CUT SNIPS - Double cut design is ideal for cutting metal pipe or duct. Double design removes a curled strip of metal from path with virtually no surface distortion. Double cut also features adjustable taper round outer blade. Offset handle design aids maneuverability and also protects user's hands.

FIG. NO.	PRICE
44764	

GAS SERVICE TOOLS

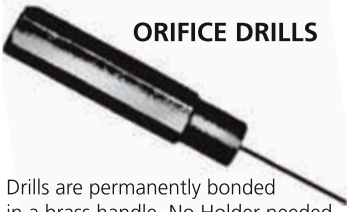

ORIFICE DRILLS

Drills are permanently bonded in a brass handle. No Holder needed.



SAFETY ANVIL

Ideal for holding orifices while drilling or reaming



REAMER

Ideal for orifices



GAS TAP



PIN VISE

For extra holding while drilling or reaming



TELESCOPING MATCH HOLDER

Fig No. 8881



INSPECTION MIRROR

Fig No. 8893



HYDROGAUGE MANOMETER

For measuring gas pressure. 0.16 inches water column size. Rubber tubing included.

Fig No. 44664



ORIFICE DRILL SET

- Packed in a heavy-duty case to prevent breakage or falling out
- Set contains 41 drills sizes #40-#80
- Drills are permanently bonded in a brass handle
- Replacement drills available

Fig No. 50690

DIGITAL POCKET THERMOMETER



Fig No. 47581

POCKET THERMOMETER



Fig No. 8868

GENERAL TOOL IRTC50 ENERGY AUDIT & IR THERMOMETER-SCANNER



- In scanning mode, the color of the light panel (red, green or blue) and the beeper speed (fast, silent or slow) indicate whether the target is above, within or below the reference temperature \pm the setpoint bandwidth
- Choice of three setpoint bandwidths 1°, 5° and 10°F (0.5°, 3°, 5.5°C)
- Squeezing and holding the trigger captures a reference temperature and launches scan mode
- Unique Star Burst laser targeting system helps approximate the target/spot size
- Large backlit LCD
- Auto power off
- NIST calibration is available

GENERAL TOOL DKP300MA DIGITAL WATERPROOF KEYPAD THERMOMETER



- The DKP300MA Digital Waterproof Keypad Thermometer reads surface temperature
- The industrial digital thermometer has a wide measurement range from -58 degrees to 302 degrees Fahrenheit and can also show readouts in Celsius
- Pool thermometer high and low alarms alert when temperature has stooped low or peaked too high; features both min and max memory along with data hold
- Stainless steel sensor probe and protective plastic cap for thermometer probe ensure that probe thermometer is sure to remain protected/long lasting
- Pocket thermometer comes with a pocket clip and is CE approved; power source is 1 LR44 battery (included) with auto power-off for saving battery life
- Waterproof thermometer is perfect for aquarium, whirlpool therapy and pool maintenance



FLANGE TOOL To install and remove circular flanges as found in circulator pumps.

FIG. NO.
72715

**GENERAL TOOLS GPK015
GAS TEST GAUGE**



- Large 2-inch sensitive diaphragm gauge is calibrated in inches of water column and also shows in ounces per square inch.
- Magnified lens
- Easier to use than a manometer
- Molded hard case
- Brass fitting for quick connection to the appliance manifold 3/8-inch NPT

GAUGE GLASS CUTTER



Standard Gauge Glass Cutter with Carbide Wheel for Round Tubular Gauge Glasses.

FIG. NO.	PRICE
17470	

SQUEEZE & POP GLASS CUTTER



Cuts cast iron, tile and asbestos cement pipe in seconds with no turning. Cutter chain is wrapped around tubing right at the point where cut is to be made. Any length from 1/2" to several feet may be cut. Cuts up to 3/4" OD.

FIG. NO.	PRICE
17473	

PINCH AND CUT GLASS CUTTER



Forged Bronze. For cutting by the rotation of a hardened steel wheel about the outside of a tube of any size not larger than 1-1/8". It employs two V guides to align the tubing at a position normal to the cut. The wheel is held normally open by a coil spring.

FIG. NO.	PRICE
49662	

PINCH OFF TOOL



FIG. NO.	PRICE
41063	

**GRIPZIT
Grip-It strap wrench**



Completely adjustable. Urethane covered. High strength belting attached to lightweight I-beam handle. Patented "Cam-Action" design permits uniform high torque application. Ideal for glass, plastic and metal applications.

FIG. NO.
58241

DUFF IS ALWAYS



**365 DAYS A YEAR
24 HOUR
EMERGENCY SERVICE**



Blow Out Gun - For cleaning oil lines, hydraulic lifts, lub systems, transmission units. Clears blockages with CO2. 1/4 Female connection.

FIG NO.	DESCRIPTION
270715	Blow Gun
237444	CO2 Cartridge (12 pk)

DUFF has all the useful tools you need for any job!

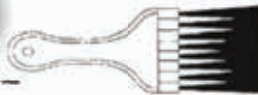

Fin and coil brush. Stiff polypropylene bristles firmly imbedded in plastic handles. Ideal for cleaning inbetween small fins and coils. Small whisk type brush.

FIG. NO.	PRICE
16415	



AWWA VALVE KEY
2 3/4 square operator nut x 6'
For municipal water valves.

FIG. NO.	PRICE
67056	



UTILITY KNIFE

FIG. NO.	PRICE
19777	

BLADE ONLY (5 PACK)

42464	
-------	--

Telescopic magnet for picking up metal objects out of reach.



FIG. NO.	PRICE
50706	

POCKET CALIPER

Pocket caliper eliminates the need to remove parts for measurement.



FIG. NO.	PRICE
50707	



EXTRA HEAVY DUTY FIN COMB

Extra heavy duty fin comb with super sure grip handle for AC coil fins.

FIG. NO.	PRICE
85599	

MANHOLE PULLING TOOL



FIG. NO.
173502

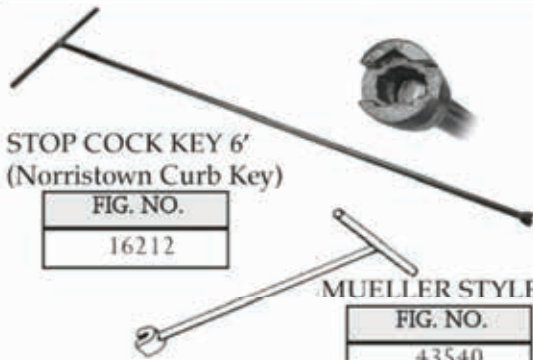

STOP COCK KEY 6'
(Norristown Curb Key)

FIG. NO.
16212

MUELLER STYLE

FIG. NO.
43540



PLUMBERS CANDLE

FIG. NO.	PRICE
51061	

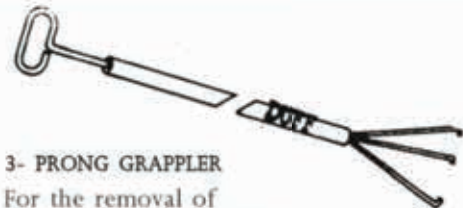

3- PRONG GRAPPLER

For the removal of obstructions from water boxes.

SIZE	FIG. NO.	PRICE
8'	16209	
6'	19831	

WATER PRESSURE TESTING GAUGE



Accurate and dependable. Used for ascertaining correct water pressure and to determine the proper selection and adjustment of relief valves, regulators, etc. Gauge is 2 1/2" dia. with unbreakable clear plastic crystal. Finished in black, with standard hose connection at top - the spud fitted with pressure reducing bushing. 0 lbs. to 300 lbs.

WATER PRESSURE TESTING GAUGE

FIG. NO.	PRICE
3695	

DUFF DELIVERS



SAWS



"TEENY WEENY" MIDGET
FRAME AND BLADE

FIG. NO.	PRICE
39909	
10 PACK, 6-INCH MIDGET BLADES. WAVY SET BLADE WITH FLEXIBLE BACK AND HARD TEETH. SMOOTH, RAPID CUT- TER. REMOVES VERY LITTLE STOCK IN CUTTING.	
FIG. NO.	PRICE
39910	



SQUARE TIP PVC SAW

FIG. NO.	PRICE
18"	38148
12"	48993
BLADE ONLY	
FIG. NO.	PRICE
18"	38149
12"	48996



RIDGID

RIDGID MASTER GRIP
FRAME HACK SAW WITH
TENSION WHEEL

FIG. NO.	PRICE
13635	

LENOX BRAND
MODEL 4012

FIG. NO.	PRICE
48995	

PVC CABLE SAW

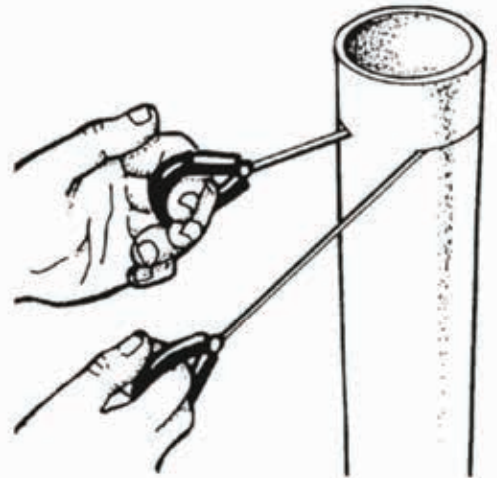

PVC CABLE SAW

FIG. NO.	PRICE
49240	

If you
don't see it ...
just ask us



MINISAW

For hard to get to spots



FIG. NO.
16149

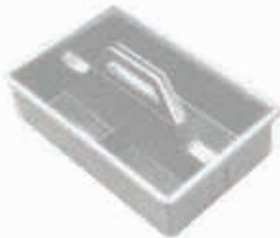

TOOL TOTE - Crush proof, heavy duty tote tray, ideal for carrying tools and supplies to jobsite. made of tough polypropylene, long wearing, rust proof, portable and lightweight. Three compartments to accommodate tools and supplies. Comfortable handle-grip - will not bite into palm of hand. 10"W X 15"L X 4 1/2"D.

FIG. NO.	PRICE
38088	

est. 1947

DUFF CO.

When you need it now... or don't know how



PVC TOOLS

DEBURRING TOOL

For plastic pipe and tubing. Quickly removes inside burrs and outside ridges. Tool is applied to the outer or inner surface of the cut end of pipe or tubing and twisted under pressure.

Result, a neatly chamfered or reamed end. High grade steel with specially designed cutting edges. Vinyl cushion hand grip.

DESCR	FIG. NO.	PRICE
1/2-1 1/2	13140	
1 1/2 - 3	83968	
4	83967	



PVC INSIDE PIPE CUTTER

Cuts 2" and larger pipe.

FIG. NO.	PRICE
35990	

PVC NIPPLE EXTRACTOR



FIG. NO.	PRICE
50673	

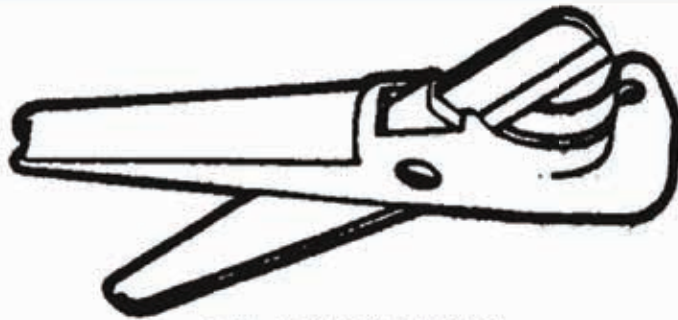

LI'L AND BIG NIPPERS

These cutters do not distort the pipe allowing insert fitting to slide into flexible pipe easier - and allow cement fittings to slide onto rigid pipe as easily as possible.

PIPE SIZE	FIG. NO.	PRICE
1/2" - 1"	17480	
1" - 2"	50467	

PVC RAM BIT



WORKS ON:

ABS DWV *PVC DWV *PVC PRESSURE *Rigid PVC Electrical Conduit *Schedule 40 and 80 *Class 125, 160 and 200 *All sizes fit 3/8" power drill *Works with a heavy duty, cordless 3/8" rechargeable drill *Fits common drill bit extensions.

FIG. NO.	SIZE	CL 125	CL 200	SCH 40	SCH 80	DRILL SIZE	PRICE
49650	1/2"	X		X	X	3/8" or	
49651	3/4"	X	X	X	X	heavy duty	
49652	1"		X	X	X	3/8"	
49653	1 1/4"		X	X	X	recharge-	
49654	1 1/2"		X	X	X	able	
49655	2"		X	X	X		
50704	3"		X	X		1/1"	
50705	4"			X		variable	





PIPE EXTRACTORS

RIDGID pipe extractors make easy work of removing broken threaded ends of pipe, pipe plugs, fittings, etc. Each is plainly marked showing drill size used when solid ends of plugs and fittings must be drilled to receive extractor.

OEM No.	Pipe Size
80	1/8"
81	1/4"
82	3/8"
83	1/2"
84	3/4"
85	1"
86	1-1/4"
87	1-1/2"
89	2"

S E T S

DESCRIPTION	SIZES	FIG. NO.	PRICE
Nos. 81 to 85 inclusive	1/4-1	28650	
Nos. 80 to 85 inclusive	1/8-1	28651	

Call today for pricing and availability

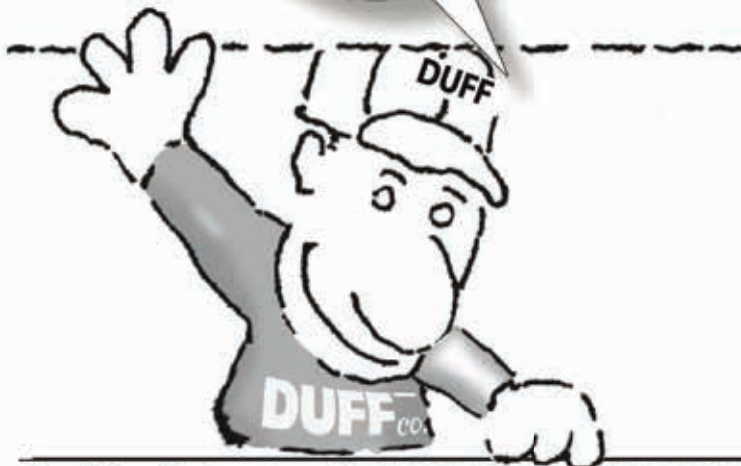

INTERNAL PIPE WRENCH



Tool to remove nipples. Eccentric action grips inside of pipe.

SIZE	FIG. NO.	PRICE
3/8	16224	
1/2	16225	
3/4	16227	
1	16228	
SET OF 4	40720	

TAPS



Carbon Steel right hand pipe taps. High quality, made in USA

SIZE	FIG. NO.	PRICE
1/8	12975	
1/4	12977	
3/8	12978	
1/2	12980	
3/4	12983	
1	12985	
1 1/4	12986	
1 1/2	12988	
2	12990	
2 1/2	12992	
3	17154	
3 1/2	35354	
4	17156	



RIGID HAND SPINNERS

High Quality, Excellent Performance Designed to Clear Blockages Quickly and Efficiently Rugged and Durable Cable

K-26 HAND SPINNER For 3/4" to 1 1/2" (19-40 mm) Drain Lines



Ideal for users seeking excellent performance and value. Features include:

- Slip-resistant collet chuck that grips/releases cable with the flick-of-the-wrist.
- 5/16" x 25' hollow core cable w/ bulb head auger.
- Rotary molded plastic drum that won't rust or dent – cleans easily.
- Open drum design that permits access to cable and allows application of Cable Rust Inhibitor.

Catalog No.	Model No.	Description	Dia. x Length		Weight	
			in. x ft	mm x m	lb.	kg
59812	K-26	Hand Spinner w/C-1 Bulb Head Cable	5/16" x 25'	8 x 7.6	6	2,7

K-25 HAND SPINNER For 3/4" to 1 1/2" (19-40 mm) Drain Lines



Model K-25 Hand Spinner is the ideal tool for the user who demands the best.

Features include:

- Premium-quality, precision machined, 3-jaw chuck to firmly secure cable. Releases cable with a flick-of-the-wrist.
- Non-slip cast aluminum ribbed hand grip.
- Rotary molded plastic drum that won't dent or rust – cleans easily.
- Available in bulb head and drop head models. Kink-resistant cables.
- Well balanced for comfortable operation.
- Capacity for 5/16" x 35'.

Catalog No.	Model No.	Description	Dia. x Length		Weight	
			in. x ft	mm x m	lb.	kg
58890	K-25-BP	Hand Spinner w/C-1K Bulb Head Cable	5/16" x 25'	8 x 7.6	8	3,6
58895	K-25-DH	Hand Spinner w/C-1K Drop Head Cable	5/16" x 25'	8 x 7.6	8	3,6

HAND SPINNERS	K-25	K-26
APPLICATION	SINK / TUB LINES	
Line Size	3/4 - 1 1/2"	3/4 - 1 1/2"
Drum Capacity	35' of 5/16" Cable	25' of 5/16" Cable
Head Type	Bulb Head/ Drop Head	Bulb Head
Weight	8 Lbs.	6 Lbs.

TOILET AUGERS



Model K-3/K-6 Toilet Augers

High quality tools in 3' and 6' lengths provide fast and efficient clearing of toilet obstructions.

Features include:

- Vinyl guard to protect porcelain.
- Large, ergonomically designed handles.
- Negotiate water-conserving toilets.
- New durable, kink-resistant, 1/2" Cable.
- Available in either drop head or bulb head models.

Catalog No.	Model No.	Description	Weight		Standard Pack	Replac. Cables
			lb.	kg		
59787	K-3	3' Toilet Auger w/Bulb Head	4-3/8	2.0	6	-
59797	K-6	6' Toilet Auger w/Bulb Head	5-1/2	2.5	6	60362
59802	K-6 DH	6' Toilet Auger w/Drop Head	5-1/2	2.5	6	60367

	K-3	K-6
Vinyl Guard for Porcelain	YES	YES
1/2" Compression-Wound Core Cable	YES	YES
Negotiates Water-Conserving Toilets	YES	YES
Available in Bulb Head or Drop Head	NO	YES
Cabled Length	3'	6'

KWIK-SPIN® Hand Spinner With AUTOFEED®

The new and improved KWIK-SPIN® is an excellent choice for clearing blockages from small drain lines in showers, sinks, and tubs. The patented AUTOFEED® trigger automatically feeds and retracts the cable as the drum turns.

The AUTOFEED trigger makes the job quick and simple:

- Clean Hands Operation – Avoid mess and minimize job-site cleanup.
- Easily Feeds Cable – Trigger lock allows smooth, nonstop operation so you can get on to the next job.

KWIK-SPIN features:

- Trigger lock button eliminates hand fatigue.
- 25' of high-strength, kink-resistant 1/4" MAXCORE® cable.
- Comfortable, reinforced hand grip.
- Lightweight, polyethylene drum will not dent or rust.

View video at www.RIDGID.com/KWIKSPIN for user tips.

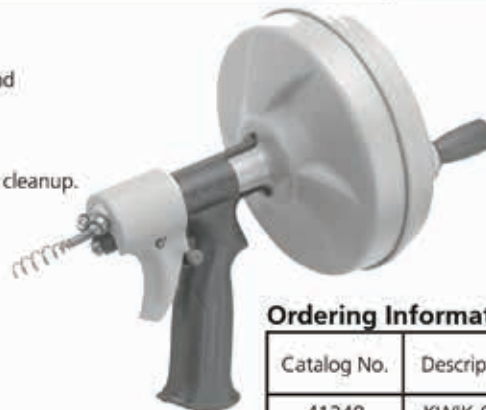

Ordering Information

Catalog No.	Description	Cable	Weight (lbs.)	kg
41348	KWIK-SPIN	25' x 1/4" MAXCORE	3.9	1.8

RIDGID SINK MACHINES

Small Line Cleaning — Lightweight and Convenient — Patented AUTOFEED® Technology



Application Chart

Sink Machine Cables

K-40 & K-45	
3/8" CABLE	5/16" CABLE
25' w/Male Coupling	25' w/Bulb Auger
35' w/Bulb Auger 25'	w/Drop Head Auger
35' w/Male Coupling	35' w/Bulb Auger
—	35' w/Drop Head Auger
—	50' w/Bulb Auger
—	50' w/Bulb Auger

	K-40	K-45
APPLICATION	SINK / TUB LINES	
LINE SIZE	3/4 - 2 1/2"	3/4 - 2 1/2"
STANDARD CABLE LENGTH	35'	25'
DRUM CAPACITY	50' of 5/16" Cable	50' of 5/16" Cable
SPEED	270 RPM	0-600 RPM
MOTOR TYPE	1/8 HP Induction Motor	Variable Speed Drill
WEIGHT	36 Lbs.	13 Lbs.
OTHER FEATURES	Optional Two-way AUTOFEED® & Guide Hose	Optional Two-way AUTOFEED®

K-45 SINK MACHINE

For 3/4" to 2 1/2" (19-64 mm) Drain Lines

- Excellent for small line cleaning. Opens clogged lavatory, sink lines, urinals, and tub/shower drains.
 - 1/4" cables best for 3/4" to 1 1/2" lines.
 - 5/16" cables best for 3/4" to 1 1/2" lines.
 - 3/8" cables best for 1 1/4" to 2 1/2" lines.
- Available in 2 styles: Manual & Autofeed®.
 - Manual version has a slide action chuck for quick locking/releasing of cable.
 - Advanced two-way AUTOFEED® keeps hands and work area clean – advances & retrieves cable with push of a lever.
- Lightweight, easy-to-use, no setup required.
- Variable speed power unit rotates cable 0-600 RPMs.
- Two-piece twist lock canister with interchangeable inner drum.
 - Makes cable changeout simple; easy to match the right cable to the job.
 - Inner drum prevents water leaks and greatly reduces cable flip-over inside the drum.
 - Drums won't rust or dent – ever.
- Drum Capacity: 50' of 5/16" (15 m/8 mm) or 35' of 3/8" (11 m/10 mm).
- Includes RIDGID drain cleaning gloves and operator's manual.
- Approved by CSA to CSA and UL Standards (115V only).

K-45AF Machine with Slide Action Chuck and Autofeed			DESCRIPTION	WEIGHT		K-45 Machine with Slide Action Chuck		
CATLOG NO.		MODEL NO.		LB.	KG.	MODEL NO.	CATLOG NO.	
115V	230V						115V	230V
35473	36033	K-45AF	11	5,0	K-45	36018	36048	
35998	36038	K-45AF-1	27	12,2	K-45-1	36013	36053	
36003	36043	K-45AF-5	34	15,4	K-45-5	36023	36058	
36008	n.a.	K-45AF-7	42	19,0	K-45-7	36028	—	



RIDGID DRUM MACHINES

APPLICATION CHART



APPLICATION	SINK LINES		FLOOR/SECONDARY DRAINS			
			LATERAL & MAIN LINES			
	LINE SIZE	1/2" - 4"	3/4" - 4"	3" - 6"	3" - 8"	3" - 6"
SPEED	170 RPM	240 RPM	285 RPM	200 RPM	200 RPM	200 RPM
MOTOR TYPE - HP	Induction 1/3 HP	Universal 1/12 HP	Universal 4/10 HP	Induction 1/2 HP	Induction 1/2 HP	Universal 4/10 HP
WEIGHT	60 Lbs.	65 Lbs.	180 Lbs.	206 Lbs.	194 Lbs.	244 Lbs.
RECOMMENDED CABLE	Integral Wound	Inner Core	Inner Core	Inner Core	Inner Core	Inner Core



Model K-400
Machine Only



Model K-400
With AUTOFEED®



Machine Options

CATA-LOG NO.	MODEL NO.	DESCRIPTION	WEIGHT	
			LB.	KG.
26993	K-400 w/C-31 IW	K-400 Machine w/RIDGID Drain Cleaning Gloves - C-31 IW 3/8" x 50' Solid Core (Integral Wound) Cable - T-260 Tool Set Includes: - T-202 Bulb Auger - T-205 "C" Cutter - T-211 Spade Cutter - A-13 Pin Key	60	27,2
24853	K-400 w/C-32 IW	K-400 Machine w/RIDGID Drain Cleaning Gloves - C-32 IW 3/8" x 75' Solid Core (Integral Wound) Cable - T-260 Tool Set	68	31
27008	K-400 AF w/C-32 IW	K-400 Machine w/RIDGID Drain Cleaning Gloves - AUTOFEED - C-32 IW 3/8" x 75' Solid Core (Integral Wound) Cable - T-260 Tool Set	79	36
27003	K-400 w/C-44 IW	K-400 Machine w/RIDGID Drain Cleaning Gloves - C-44 IW 1/2" x 50' Solid Core (Integral Wound) Cable - T-260 Tool Set	68	31
26998	K-400 w/C-45 IW	K-400 Machine w/RIDGID Drain Cleaning Gloves - C-45 IW 1/2" x 75' Solid Core (Integral Wound) Cable - T-260 Tool Set	81	37
27013	K-400 AF w/C-45 IW	K-400 Machine w/RIDGID Drain Cleaning Gloves - Autofeed - C-45 IW 1/2" x 75' Solid Core (Integral Wound) Cable - T-260 Tool Set	93	42
41937	-	RIDGID Drain Cleaning Gloves, Leather	-	-

For 1 1/2" to 4" (32-100 mm) Drain Lines
The Model K-400 offers several unique, user-friendly features to make the toughest drain cleaning jobs easier and hassle-free. Designed with a sleek profile, the Model K-400 is a great fit for drain cleaners, service plumbers, facility and institutional maintenance departments and property management companies.

- 100' of 3/8" cable for 1 1/2" to 3" lines.
- 75' of 1/2" cable for 3" to 4" lines
- Integrated Transport Cart – allows for easy movement to and from the job site. Heavy-duty, large wheels easily navigate over bumps and up stairs.
- Integrated Telescoping Handle – provides high-handle height during transport. Handle locks in low position during drain cleaning operation or during transport to minimize space requirements.
- Cable Control System – causes the drum to stop spinning when the blade becomes lodged in a blockage, limits potential for cable to flip-over in the drum and helps to indicate to operator when blockages are encountered.
- "Solid Core" Cable – uses tough 3/8" or 1/2" Integral Wound (IW) solid core cable that is rugged and kink resistant. Each size comes in several lengths and utilizes a variety of the RIDGID quick-connect cutters.
- AUTOFEED® – offered as an accessory, this patented, automatic cable feed powers cable in and out of the drain. Reverse the direction of the AUTOFEED® and the cable feeds back into the drum.
- Approved by CSA to CSA and UL Standards (115V only).



RIDGID DRUM MACHINES

K-3800



For 3/4" to 4" (19-100 mm) Drain Lines

- A powerful, easy to transport, versatile machine for cleaning indoor drains. Requires minimal setup to clean sink lines, floor drains and roof vents.
- Rugged, corrosion-resistant molded cable drum won't dent or rust. The drum tilt adjusts for proper cable feed angle. Inner drum guards against cable flip-over inside the drum.
- Cable drum's quick-release and built-in hand-holds allow easy cable change and transport.
- Standard drum capacity is 100' of 3/8" or 90' of 1/2" (30 m/10 mm or 27 m/12 mm) continuous length cable:
 - 3/8" cable best for 1 1/2" to 3" lines up to 100'.
 - 1/2" IC cable best for 2" to 4" lines up to 90'.
- Optional sink drum holds up to 50' of 5/16" or 1/4" (15 m/8 mm) cable. – Ideal for cleaning through 3/4" to 1 1/2" sink traps.
- Powerful 1/12 HP universal motor spins cable at 240 RPM. When cable hits blockage, motor gears down automatically to deliver more power and enhance operator control.
- Tools connect to cable in seconds.
- Approved by CSA to CSA and UL Standards (115V only).
- IW (Integral Wound) cables available. IW cables are slightly stiffer and more kink resistant. All IW cables use 3/8" T-200 series cutters.
- Includes RIDGID leather drain cleaning gloves and operator's manual.

MACHINE OPTIONS

Got Drain Cleaning Questions?

Call and ask DUFF

We've got the solution you need.



Catalog No.		Model No.	Description	Weight	
115V	220-240V			LB.	KG.
53107	59462	K-3800	K-3800 Machine w/RIDGID Gloves	42	19,0
53112	-	K-3800 w/C-31	K-3800 Machine with: – C-31, 3/8" x 50' Cable – T-202 Bulb Auger – T-205 "C" Cutter – T-211 Spade Cutter – A-13 Pin Key – RIDGID Leather Drain Cleaning Gloves	65	29,25
53117	63827	K-3800 w/C-32	K-3800 Machine with: – C-32, 3/8" x 75' Cable – T-202 Bulb Auger – T-205 "C" Cutter – T-211 Spade Cutter – A-13 Pin Key – RIDGID Leather Drain Cleaning Gloves	71	32,2
53122	63822	K-3800 w/C-45	K-3800 Machine with: – C-45, 1/2" x 75' Cable – T-102 Funnel Auger – T-142 Knife Blade Cutter – T-107 Spade Cutter – A-12 Pin Key – RIDGID Leather Drain Cleaning Gloves	83	37,7
53127	-	K-3800 w/C-46	K-3800 Machine with: – C-46, 1/2" x 90' Cable – T-102 Funnel Auger – T-142 Knife Blade Cutter – T-107 Spade Cutter – A-12 Pin Key – RIDGID Leather Drain Cleaning Gloves	91	41,3
41937		-	RIDGID Drain Cleaning Gloves, Leather	-	-

DRUM MACHINES

RIDGID

K-6200



For 3" to 6" (75-150 mm) Drain Lines

- A powerful, easy to transport, versatile machine for cleaning indoor drains. Superior maneuverability and a small footprint allow easy access to tight work areas. The Model K-6200 comes equipped with either IC (Inner Core) cable or HD (Heavy Duty Inner Core) cable.

Recommend 5/8" cable for 3" to 6" drain lines up to 200'.

- Patented Cable Control System – Causes the drum to slow down when the blade becomes lodged in a blockage. Limits potential for cable flip-over inside the drum.
- Direct Drive Design – 4/10 HP universal motor and gearbox bear down as torque builds. Motor sound lets the operator know when blockage is encountered. Drum requires no adjustments to stay aligned and tight on drive shaft.
- Easy Maintenance Construction – Separate drum and machine in seconds. Inner drum and guide tube remove easily to maintain or replace cable.
- Durable and Stable – Low center of gravity frame design and custom kickstand keep machine firmly anchored during operation. Rugged, corrosion-resistant polyethylene drum is rust and dent proof. Double tubular frame is lightweight and designed for extra strength.
- AUTOFEED and Standard Accessories – Powerful feed mechanism is built to last and is easily maintained. Autofeed, toolbox and selection of cutters included in all models.
- Approved by CSA to CSA and UL Standards (115V only).
- Includes RIDGID PVC drain cleaning gloves and operator's manual.

MACHINE OPTIONS — POWER FEED

Catalog No.	Model No.	Description	Weight	
			LB.	KG.
95737	K-6200	Machine, Standard Accessories w/5/8" Pigtail	98	44,54
95732	K-6200 w/C-24	Machine, Standard Accessories and 5/8" x 100' Inner Core Cable	180	81,81
93557	K-6200 w/C-24 HD	Machine, Standard Accessories and 5/8" x 100' HD Inner Core Cable	180	81,81
70032	–	RIDGID Drain Cleaning Gloves, PVC	–	–



Standard Accessories:

- T-406 Spade Cutter
- T-411 2" Double Cutter
- T-413 3" Double Cutter
- T-414 4" Double Cutter
- T-458 5/8" x 2' Trap Leader (Not Shown)
- Pair Reclining Legs
- RIDGID Drain Cleaning Gloves



DRUM MACHINES

K-750

For 3/4" to 8" (19-200 mm) Drain/Sewer Lines

- Powerful, self-contained machine ideal for lateral lines. Easy to transport, minimal set-up – attach a tool and go.
- Autofeed advances, retrieves cable with a push of a lever, up to 20' per minute.
- Versatile autofeed adjusts for either 5/8" or 3/4" cable with a twist of a screwdriver.
 - Recommend 5/8" cable for 3" to 6" drain lines up to 150' (75-150 mm, 48 m).
 - Recommend 3/4" cable for 4" to 8" drain lines up to 200' (100-250 mm, 62 m).
- Cable spins at 200 RPM.
- Tough, corrosion-resistant cable drum withstands harsh treatment and abuse. It will not dent or corrode and cleans easily.
- Drum holds 100 feet of 3/4" (30 m, 19 mm) or 125 feet of 5/8" (35 m, 16 mm) cable and is designed for quick, easy removal.
- Well-balanced design gives machine a lightweight "feel." Transport wheels ease loading into service truck/van.
- Equipped with 1/2 HP induction motor.
- Approved by CSA to CSA and UL Standards (115V only).
- Includes RIDGID PVC drain cleaning gloves and operator's manual.



Standard 3/4" Tool Set Includes:

- T-406 Spade Cutter
 - T-407 Retrieving Auger
 - T-411 2" Cutter
 - T-413 3" Cutter
 - T-414 4" Cutter
- Standard 5/8" Tool Set
 - T-403 3" P-Trap Cutter
 - T-406 Spade Cutter
 - T-407 Retrieving Auger
 - T-411 2" Cutter
 - T-413 3" Cutter

Catalog No.		Model No.	Description	Weight	
115V	220-240V			LB.	KG.
41977	44202	K-750	Machine with RIDGID Drain Cleaning Gloves, AUTOFEED - 3/4" Pigtail	114	51,9
51402	51407	K-750	Machine with RIDGID Drain Cleaning Gloves, Autofeed - 5/8" Pigtail	113	51,3
42002	—	K-750 w/C-75	Machine with RIDGID Drain Cleaning Gloves, Autofeed, Standard 3/4" Tool Set, and: C-75, 75' x 3/4" Cable	206	93,6
42007	44212	K-750	Machine with RIDGID Drain Cleaning Gloves, Autofeed, Standard 3/4" Tool Set, and: C-100, 100' x 3/4" Cable	234	106,3
42012	44217	K-750 w/C-27	Machine with RIDGID Drain Cleaning Gloves, Autofeed, Standard 5/8" Tool Set, and: C-27, 75' x 5/8" Cable	182	82,7
47047	—	K-750 w/C-24	Machine with RIDGID Drain Cleaning Gloves, Autofeed, Standard 5/8" Tool Set, and: C-24, 100' x 5/8" Cable	182	82,7
70032		—	RIDGID Drain Cleaning Gloves, PVC	—	—



Cable advance



Cable retract

DRUM MACHINES

RIDGID

K-7500



For 3" to 10" (75-250 mm) Lines

- The performance, cable control, durability, and maneuverability demanded by professional users. Ideal for any tough job, such as roots. Clears lines up to 250' long.
 - Recommend 5/8" cable for 3" to 6" drain lines up to 250' (75-150 mm, 76 m).
 - Recommend 3/4" cable for 4" to 10" drain lines up to 250' (100-250 mm, 76 m).
- Cable spins at 200 RPM.
- Powerful, yet quiet, 4/10 HP universal motor and gearbox bear down as cutter engages tough obstructions.
 - Provides audible and visual signals to operator.
- Inner-drum and ball bearing distributor arm work with motor/gearbox system to reduce chance of cable flip-over inside the drum.
- Main and inner drums won't rust, split or dent – ever, and clean easily for professional appearance. Main drum holds up to 100' of 3/4" cable or 125' of 5/8" cable.
- Powerful autofeed mechanism has grease fittings and an open design for easy maintenance; advances and retrieves cable up to 22' per minute.
- Two-position stair climber eases transport and loading – eliminates extra cost for loading wheels.
- Narrow profile allows machine to fit through bathroom doors.
- Handles adjust to desired height to ensure balanced transport.
- Includes RIDGID PVC drain cleaning gloves and operator's manual.
- Approved by CSA to CSA and UL Standards (115V only).

STANDARD ACCESSORIES:

- T-406 Spade Cutter
- T-407 Retrieving Auger
- T-411 2" Double Cutter
- T-413 3" Double Cutter
- T-414B 4" Double Cutter - (Blade only)
- T-416B 6" Double Cutter - (Blade only)
- T-408 Sawtooth Cutter
- T-403 3" P-Trap Cutter
- T-468 3/4" Flexible Leader
- Tool Box, Hex Key, RIDGID PVC Drain Cleaning Gloves

MACHINE OPTIONS — POWER FEED

Catalog No.		Model No.	Description	Weight	
115V	220-240V			LB.	KG.
59562	61542	K-7500	Machine w/3/4" Pigtail and Standard Accessories	150	86,2
61102	61522	K-7500	Machine w/5/8" Pigtail and	149	67,8
60062	–	K-7500 w/C-75	Machine, Standard Accessories, and 3/4" x 75' Inner Core Cable	244	110,9
60052	–	K-7500 w/C-100	Machine, Standard Accessories, and 3/4" x 100' Inner Core Cable	272	123,7
41937		–	RIDGID Drain Cleaning Gloves, Leather	–	–

DUFF DELIVERS



RIDGID

SECTIONAL MACHINES



APPLICATION	SINK LINES			
	FLOOR/SECONDARY DRAINS			LATERAL & MAIN LINES
LINE SIZE	3/4" - 4"	1-1/4" - 4"	2" - 8"	2" - 10"
SPEED	400 RPM	600 RPM	710 RPM	600 RPM
HORSEPOWER	1/4 HP	1/2 HP	3/4 HP	1 HP
WEIGHT	37 Lbs.	41 Lbs.	135 Lbs.	141 Lbs.
CABLE SIZE	5/16", 3/8", 5/8"	5/8", 7/8"	7/8", 1 1/4"	7/8", 1 1/4"

CABLES FOR SECTIONAL MACHINES

APPLICATION	K-50		K-60SP		KL-1500 & K-1500SP			
	C-7	C-8	C-9	C-10	C-11	C-12	C-14	C-15
	CABLE MODEL	C-7	C-8	C-9	C-10	C-11	C-12	C-14
CABLE DIAMETER	5/8"	5/8"	5/8"	7/8"	1 1/4"	1 1/4"	1 1/4"	1 1/4"
LENGTH	7 1/2'	7 1/2'	10'	15'	15'	15'	15'	15'
LINE SIZE APPLICATION	2" - 3" Floor Drains	1 1/4" - 2" Sink Lines	2" - 4" Floor Drains, Stacks	2" - 4" Floor Drains, Stacks & Laterals	3" - 8" Floor Drains	4" - 10" Laterals, Main Lines	3" - 10" Laterals, Main Lines	3" - 6" Laterals
CHARACTERISTICS	All-around cable Not for tree roots	Flexible, ideal for sink lines	Heavy-duty cable Long indoor runs.	Excellent all-purpose cable, excellent flexibility	All-around work up to 8" lines Easily goes through 4" trap	Extra heavy-duty for long runs. Not for 4" traps	Heavy-duty	Extra flexible and lightweight

SECTIONAL MACHINES



K-50

For 3/4" to 4" (19-100 mm) Drain Lines

- Compact, versatile, professional's machine. Capable of running three different size cables: 5/16", 3/8" and 5/8". The perfect, all-around sink, shower and floor drain machine. Weighs less than 40 lbs.
- Unique, easy-to-use, instant-acting cable clutch maximizes operator control:
 - Pull handle down and cable spins at 400 RPM.
 - Release handle, cable stops instantly.
- Uses sections of 5/8" cable, cleans 1 1/4" to 4" lines up to 100 feet.
 - C-8 best for 1 1/4 to 3" drains.
 - C-9 best for 2 to 4" drains.
- Equipped with an A-17 adapter, runs up to 50 feet of 5/16" (15 m/8 mm) or 35 feet of 3/8" (11 m/10 mm) continuous length cable.
 - 5/16" best for 3/4" to 1 1/2" lines.
 - 3/8" best for 1 1/4" to 2" lines.
- Equipped with 1/6 HP 115V motor.
- Includes A-1 RIDGID drain cleaning mitt and operator's manual.
- Approved by CSA to CSA and UL Standards (115V only).



Model K-50-8 shown above includes:

- K-50 Machine
- A-17-A, Adapter includes: 25' x 5/16", C-1 Bulb Auger Cable
- A-17-B, Adapter includes: 35' x 3/8", C-5 Bulb Auger Cable
- A-1 RIDGID Drain Cleaning Mitt
- A-30 Cable Kit
 - Six Sections C-8, 7 1/2' x 5/8" Cable (45 feet)
 - A-10 Cable Carrier
 - T-201 Straight Auger
 - T-202 Bulb Auger
 - T-205 "C" Cutter
 - T-211 Spade Cutter
 - A-13 Coupling Pin Key
 - A-14-6 Rear Guide Hose
 - A-1 Left-Hand RIDGID Drain Cleaning Mitt

MACHINE OPTIONS

Catalog No.		Model No.	Description	Weight	
115V	230V			lb.	kg.
58920	76455	K-50	Machine with A-1 RIDGID drain cleaning mitt	37	16,8
58960	76475	K-50-4	Machine, with: – A-30 Cable Kit	61	27,7
58980	76485	K-50-6	Machine, with: – A-17-A Adapter – A-30 Cable Kit	67	30,4
59000	76495	K-50-8	Machine, with: – A-17-A Adapter – A-17-B Adapter – A-30 Cable Kit	77	34,9
52972	—	K-50-9	K-50-9 Machine, with: – A-40 Cable Kit	74	33,6

Catalog No.	Description
59205	RIDGID Drain Cleaning Staple Mitt, Left Handed
59295	RIDGID Drain Cleaning Staple Mitt, Right Handed

RIDGID

RIDGID FACTS:

The maintenance crew for the Cleveland Indians use RIDGID.

And Tony Stark preferred a RIDGID pipe wrench in Iron Man II.



SECTIONAL MACHINES

For 3/4" to 4" (19-100 mm) Drain Lines

- A compact machine for institutional, commercial or residential cleaning. Also ideal for septic tank vacuum truck operators. Small enough to fit into cramped spaces, yet powerful enough to clear tough blockages.
- Ideal for rooftop vent stacks. Rear handle allows for easy transporting up ladders and onto rooftops.
- Unique, easy-to-use, instant-acting cable clutch maximizes operator control.
 - Push handle down, cable spins at 600 RPM.
 - Release handle, cable stops instantly.
- Simple adjustment knob allows unit to spin both 7/8" (22 mm) and 5/8" (16 mm) diameter cable. Adjusts in seconds.
 - 7/8" cable (C-10) cleans 2" to 4" lines through 150 feet.
 - 5/8" cable (C-7, C-8, C-9) cleans 1 1/4" to 4" lines through 125 feet.
- Remove only two bolts to access jaw set for cleaning or replacement. Removal of same bolts provides access to belt drive.
- Equipped with 1/2 HP motor.
- Includes A-1 RIDGID drain cleaning mitt and operator's manual.
- Approved by CSA to CSA and UL Standards (115V only).



Model K-50-8 shown above includes:

- K-60SP Machine
- A-1 RIDGID Drain Cleaning Mitt
- A-60-12 Rear Guide Hose
- A-62 Cable Kit
 - A-8 Cable Carrier
 - Five Sections Of C-10, 7/8" Cable, Total 75'
- A-61 Tool Kit
 - T-101 Straight Auger
 - T-102 Funnel Auger
 - T-107 Spade Cutter
 - T-125 Retrieving Auger
 - T-150-1 Sharktooth Cutter
 - A-3 Tool Box
 - A-12 Pin Key

MACHINE OPTIONS

Catalog No.		Model No.	Description	Weight	
115V	220-240V			lb.	kg.
66492	66512	K-60SP	Machine with RIDGID Drain Cleaning Mitt, A-12 Pin Key, and A-60-12 Rear Guide Hose	37	16,8
66497	66517	K-60SP-SE	Machine with RIDGID Drain Cleaning Mitt, A12 Pin Key, and A-60-12 Rear Guide Hose, plus: A-61 Tool Kit, A-62 Cable Kit	92	41,7

Catalog No.	Description
59205	RIDGID Drain Cleaning Staple Mitt, Left Handed
59295	RIDGID Drain Cleaning Staple Mitt, Right Handed



SECTIONAL MACHINES

**K-1500
B FRAME**



**K-1500
A FRAME**



For 2" to 8" (50-200 mm) Drain and Sewer Lines

- The finest all-around sewer and drain cleaning machine. One man can easily clean the heaviest blockages – indoors or out. High-speed cleaning gets the job done faster...better.
- Easy-to-use, instant-acting cable clutch maximizes operator control:
 - Pull handle down, cable spins at constant 710 RPM.
 - Release handle, cable stops instantly.
- Wheels to the job site – sets up fast, cleans up fast.
- Low-profile "B" frame design will fit most crawl spaces, loads and unloads from truck easily. Upright "A" frame features cable carrier storage during transport, ideal for in-house applications.
- Equipped to run, easy to handle, 15-foot sections of 1 1/4" cable to clean 3" to 8" (32 m/200 mm) lines to 200 feet (61 m).
- Easy clutch jaw change-out adapts K-1500 to run 15-foot sections of 7/8" (4.6m/22mm) cable through 2" to 4" lines up to 175 feet (50-100 mm, 53 m).
- Equipped with 3/4 HP motor; 115V models.
- Includes RIDGID drain cleaning mitt and operator's manual.
- Approved by CSA to CSA and UL Standards (115V only).

MODEL K-1500 B W/C-11 INCLUDES:

- K-1500 B Machine with A-1 RIDGID Drain Cleaning Mitt, A-12 Pin Key, and A-34-12 Rear Guide Hose
- Seven Sections of 1 1/4" (C-11) Cable, Total 105'
- Two A-8 Cable Carriers
- Nine-Piece Tool Set
 - T-1 Straight Auger
 - T-3 Funnel Auger
 - T-6 Retrieving Auger
 - T-8 Grease Cutter
 - T-13 Sawtooth Cutter
 - T-50-1 Sharktooth Cutter
 - A-2864 Hex Key
 - A-3516 Hex Key
 - A-3 Tool Box

MACHINE OPTIONS — B FRAME

Catalog No.			Model No.	Description	Weight	
115V -60Hz	230 v -50Hz	240v -50Hz			lb.	kg.
23697	27617	–	K-1500B	Machine with A-1 RIDGID Drain Cleaning Mitt, A-12 Pin Key, and A-34-12 Rear Guide Hose*	135	61,3
23717	27597	27637	K-1500B	Machine with A-1 RIDGID Drain Cleaning Mitt, A-12 Pin Key, and A-34-12 Rear Guide Hose*, Plus: – Seven Sections 1 1/4" (C-11) Cable, Total 105' – Two A-8 Cable Carriers – Nine-Piece 1 1/4" Tool Set	256	116,1
23707	–	–	K-1500B	Machine with A-1 RIDGID Drain Cleaning Mitt, A-12 Pin Key, and A-34-12 Rear Guide Hose*, Plus – Seven Sections 1 1/4" (C-14) Cable, Total 10' – Two A-8 Cable Carriers – Nine-Piece 1 1/4" Tool Set	256	116,1

MACHINE OPTIONS — A FRAME

Catalog No.		Model No.	Description	Weight	
115V -60Hz	240v -50Hz			lb.	kg.
23692	27612	K-1500A	Machine with A-1 RIDGID Drain Cleaning Mitt, A-12 Pin Key, and A-34-12 Rear Guide Hose*	135	61,3
23712	27592	K-1500A	Machine with A-1 RIDGID Drain Cleaning Mitt, A-12 Pin Key, and A-34-12 Rear Guide Hose*, Plus: – Seven Sections 1 1/4" (C-11) Cable, Total 105' – Two A-8 Cable Carriers – – Nine-Piece 1 1/4" Tool Set	256	116,1
23702	–	K-1500A	Machine with A-1 RIDGID Drain Cleaning Mitt, A-12 Pin Key, and A-34-12 Rear Guide Hose*, Plus – Seven Sections 1 1/4" (C-14) Cable, Total 105' – Two A-8 Cable Carriers – Nine-Piece 1 1/4" Tool Set	256	116,1



Catalog No.	Description
59205	RIDGID Drain Cleaning Staple Mitt, Left Handed
59295	RIDGID Drain Cleaning Staple Mitt, Right Handed

SECTIONAL MACHINES

For 2" to 10" (50-250 mm) Drain and Sewer Lines

- All the features of the standard Model K-1500 with extra power to clean larger lines (10") and longer distances (through 300 feet). Cuts through blockages fast.
- Equipped with full 1 HP TEFC motor and heavy-duty rotary switch.
- Unique easy-to-use, instant-acting cable clutch maximizes operator control:
 - Pull handle down and cable spins at 600 RPM.
 - Release handle, cable stops instantly.
- Low-profile frame design will fit most crawl spaces.
- 10" solid ball bearing wheels.
- Easy clutch jaw change-out adapts the Model K-1500 SP to use 7/8" cable to clean 2" to 4" lines through 175 feet (order jawset A-368-X, 59325).
- Includes A-1 RIDGID drain cleaning mitt and operator's manual.
- Approved by CSA to CSA and UL Standards (115V only).



K-1500SP

MODEL K-1500SP W/C-11 INCLUDES:

- K-1500SP Machine with A-1 RIDGID Drain Cleaning Mitt and A-12 Pin Key
- A-34-12 Rear Guide Hose
- 150 Feet, Ten Sections of C-11, 1 1/4" Cable
- Three A-8 Cable Carriers
- Nine-Piece 1 1/4" Tool Package
 - T-1 Straight Auger
 - T-3 Funnel Auger with 3", 4" and 5" Blades
 - T-6 Retrieving Auger
 - T-8 2 1/2" Grease Cutter
 - T-13 2 1/2" Sawtooth Cutter
 - T-50 Sharktooth Cutter
 - A-2864 Hex Key (1/2")
 - A-3516 Hex Key (1/4")



MACHINE OPTIONS — B FRAME

Catalog No.		Model No.	Description	Weight	
120V -60Hz	220 -240v -50hz			lb.	kg.
43507	43512	K-1500SPB	Machine with A-1 RIDGID Drain Cleaning Mitt and A-12 Pin Key*, Plus: – A-34-12 Rear Guide Hose	141	64
46907	—	K-1500SPB	Machine with A-1 RIDGID Drain Cleaning Mitt and A-12 Pin Key*, Plus: – A-34-12 Rear Guide Hose – 150 Feet, Ten Sections of C-11, 1 1/4" Cable – Three A-8 Cable Carriers – A-3 Tool Box – Eight-Piece 1 1/4" Tool Package	317	144
91027	—	K-1500SPB	Machine with A-1 RIDGID Drain Cleaning Mitt and A-12 Pin Key* Plus: – A-34-12 Rear Guide Hose – C-14 Three Carrier Cable Combination Kit	297	135

MACHINE OPTIONS — A FRAME

Catalog No.		Model No.	Description	Weight	
120V	220 -240v			lb.	kg.
46837	—	K-1500SPA	Machine with A-1 RIDGID Drain Cleaning Mitt and A-12 Pin Key*, Plus: – A-34-12 Rear Guide Hose	150	68
46902	—	K-1500SPA	Machine with A-1 RIDGID Drain Cleaning Mitt and A-12 Pin Key*, Plus: – A-34-12 Rear Guide Hose – 150 Feet, Ten Sections of C-11, 1 1/4" Cable – Three A-8 Cable Carriers – A-3 Tool Box – Eight-Piece 1 1/4" Tool Package	326	148
91032	—	K-1500SPA	Machine with A-1 RIDGID Drain Cleaning Mitt and A-12 Pin Key*, Plus: – A-34-12 Rear Guide Hose & C-14 Three Carrier Cable Combination Kit	317	144

Catalog No.	Description
59205	RIDGID Drain Cleaning Staple Mitt, Left Handed
59295	RIDGID Drain Cleaning Staple Mitt, Right Handed

SECTIONAL MACHINES

Initial / Exploratory



*Tools shown are not 1/4 scale or proportional with each other.

Follow-Up

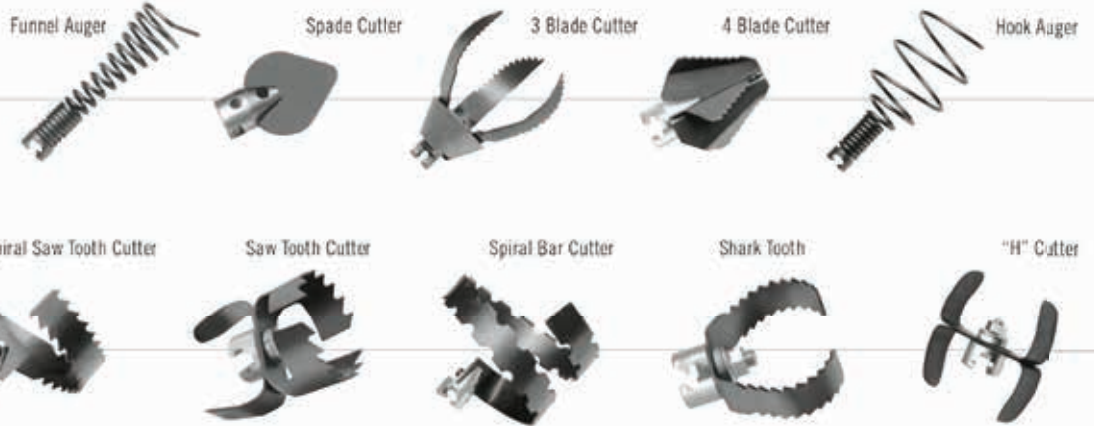

TO ATTACH TOOL



SLIDE TOGETHER

TO REMOVE TOOL



INSERT PIN

For C-4, C-6, C-6IC, C-7, C-8, C-9, C-10, C-11, C-12, C-14, C-15, C-31, C-32, C-33, C-44, C-45, and C-46 & all IW Cables.

RIDGID

Grease Blockages



Finishing Tools



Miscellaneous Tools



CABLE TOOLS

DROP HEAD AUGER
For cleaning back to back mounted fixtures e.g., sinks where cable needs to be led into down pipe.

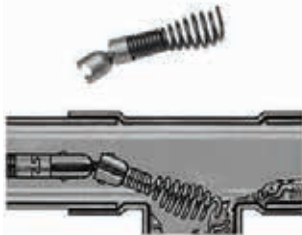

STRAIGHT AUGER
For use in exploring and breaking up stoppages or returning sample to surface to determine correct tool.



FUNNEL AUGER
For use as second tool in line. Breaks up remains of stoppage left by straight auger.



HOOK AUGER
For heavy and dense root stoppages in pipes that require hooking and breaking up.

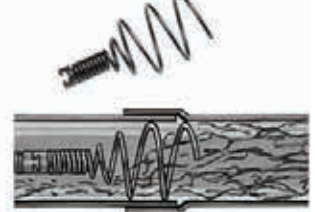

RETRIEVING AUGER
For searching for cable which is broken or lost in line.

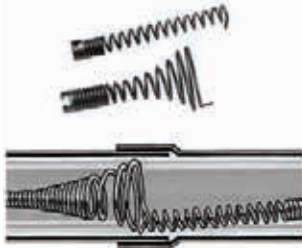

SPADE CUTTER
For following up after augers have been used and to open up floor drains.

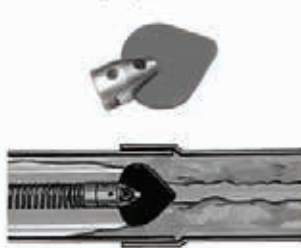

FOUR BLADE SAW TOOTH CUTTER
For blockages caused by hardened, glazed material such as chemical deposits.



GREASE CUTTER
For lines which have become badly greased with detergents and have to be opened.



SPIRAL SAW TOOTH CUTTER
For clearing any stoppage, roots, rags, sticks, etc.



SAW TOOTH CUTTER
For cleaning lines blocked heavily with roots. Unique design permits cutter to be removed from damaged pipe without locking.



SPIRAL BAR CUTTER
For main sewers blocked by roots, leaf debris, sticks, sawdust, cloth, and sacking.



SHARKTOOTH CUTTER
For use in cleaning pipes of general material clinging to pipe walls.

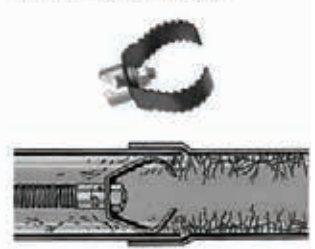

GREASE "C" CUTTER
For grease blockage in lines leading from garbage disposal unit or waste pipe.



EXPANDING FINISH CUTTERS
For final removal of material adhering to walls and certain roots of fibrous nature.

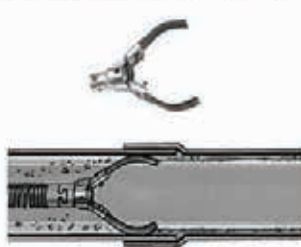

CHAIN KNOCKER
For use when vigorous action is required for cleaning of scale in pipes and boiler tubes.



FLUE BRUSH
For use for finish cleaning required of boiler tubes and heat exchangers.



DRUM CABLES



CABLE TYPE	CATALOG NO.	MODEL NO.	CABLE DESCRIPTION	K400	K3800	K6200	K750	K7500	K750R
SINK DRUM	50652	S-2	¼" x 25' w/ Funnel Auger		x				
	50657	S-3	¼" x 35' w/ Funnel Auger		x				
	56782	C-11C	⅝" x 25' Inner Core w/ Bulb Auger		x				
	56792	C-13IC	⅝" x 35' w/ Bulb Auger		x				
	56787	C-21C	⅝" x 25' Inner Core w/ Drop Head Auger		x				
	56797	C-23IC	⅝" x 35' w/ Drop Head Auger		x				
⅝" CABLES	87577	C-31IW	⅝" x 50' Integral Wound Cable	x	x				
	87582	C-32IW	⅝" x 75' Integral Wound Cable	x	x				
	87587	C-33IW	⅝" x 100' Integral Wound Cable	x	x				
	37842	C-31	⅝" x 50' Inner Core Cable		x				
	37847	C-32	⅝" x 75' Inner Core Cable		x				
	37852	C-33	⅝" x 100' Inner Core Cable		x				
½" CABLES	87592	C-44IW	½" x 50' Integral Wound Cable	x	x				
	87597	C-45IW	½" x 75' Integral Wound Cable	x	x				
	37857	C-44	½" x 50' Inner Core Cable		x				
	37862	C-45	½" x 75' Inner Core Cable		x				
	37867	C-45HC	½" x 75' Hollow Core Cable		x				
	55467	C-46	½" x 90' Inner Core Cable		x				
¾" CABLES	92460	C-25	¾" x 25' Inner Core Cable			x	x	x	x
	92465	C-26	¾" x 50' Inner Core Cable			x	x	x	x
	92470	C-27	¾" x 75' Inner Core Cable			x	x	x	x
	43647	C-24	¾" x 100' Inner Core Cable			x	x	x	x
	32737	C-27HC	¾" x 75' Hollow Core Cable			x	x	x	x
	58192	C-24HC	¾" x 100' Hollow Core Cable			x	x	x	x
	37628	C-25HD	¾" x 25' Heavy Duty Cable			x	x	x	x
	37633	C-26HD	¾" x 50' Heavy Duty Cable			x	x	x	x
	37638	C-27HD	¾" x 75' Heavy Duty Cable			x	x	x	x
	37643	C-24HD	¾" x 100' Heavy Duty Cable			x	x	x	x
⅞" CABLES	92475	C-28	⅞" x 25' Inner Core Cable				x	x	x
	92480	C-29	⅞" x 50' Inner Core Cable				x	x	x
	41212	C-75	⅞" x 75' Inner Core Cable				x	x	x
	41697	C-100	⅞" x 100' Inner Core Cable				x	x	x
	47427	C-75HC	⅞" x 75' Hollow Core Cable				x	x	x
	47432	C-100HC	⅞" x 100' Hollow Core Cable				x	x	x



DRUM CABLE TOOLS

CATALOG NO.	MODEL NO.	DESCRIPTION	K-400	K-3800	K-6200	K-750	K-7500	K750R
62990	T-201	Straight Auger-5" Long	x	x				
62995	T-202	Bulb Auger-1½"OD	x	x				
63000	T-203	Bulb Auger-¾"OD	x	x				
54837	T-204	C-Cutter- 1"	x	x				
63005	T-205	C-Cutter- 1½"	x	x				
63010	T-206	Funnel Auger-3"	x	x				
63015	T-207	Spiral Cutter-1½"	x	x				
63020	T-208	Spiral Cutter-1½"	x	x				
63025	T-209	Spiral Cutter-2"	x	x				
63030	T-210	Spade Cutter-1"	x	x				
63035	T-211	Spade Cutter-1½"	x	x				
63040	T-212	Spade Cutter-1½"	x	x				
63045	T-213	4-Blade Cutter-1"	x	x				
63050	T-214	4-Blade Cutter-1½"	x	x				
63055	T-215	4-Blade Cutter-1¾"	x	x				
63060	T-216	Chain Knocker-2"	x	x				
63065	T-217	Drop Head-4" Long	x	x				
52812	T-230	H-D "C" Cutter-2"	x	x				
52817	T-231	H-D "C" Cutter-2½"	x	x				
52822	T-232	H-D "C" Cutter-3"	x	x				
92485	T-403	P Trap Cutter-3"			x	x	x	x
92490	T-404	P Trap Cutter-3"			x	x	x	x
92495	T-406	Spade Cutter 1½"			x	x	x	x
92500	T-407	Funnel Retrieving Auger-2½"			x	x	x	x
92505	T-408	Sawtooth Cutter-3"			x	x	x	x
51762	T-409	H-D Bulb Auger-1½"			x	x	x	x
92510	T-411	Double Cutter-2"			x	x	x	x
92515	T-412	Double Cutter-2½"			x	x	x	x
92520	T-413	Double Cutter-3"			x	x	x	x
92525	T-414	Double Cutter-4"			x	x	x	x
92530	T-416	Double Cutter-6"			x	x	x	x
92535	T-432	3-Blade Cutter-2"			x	x	x	x
92540	T-433	3-Blade Cutter-3"			x	x	x	x
92545	T-434	3-Blade Cutter-4"			x	x	x	x
92550	T-436	3-Blade Cutter-6"			x	x	x	x

SINK/SECTIONAL CABLES

RIDGID

CABLE TYPE	CATALOG NO.	MODEL NO.	CABLE DESCRIPTION	K50	K60	K1500	K1500SP	K1500G
5/8" CABLES	62225	C-1	5/8" x 25' w/ Bulb Auger	x				
	56782	C-11C	5/8" x 25' Inner Core w/ Bulb Auger	x				
	89400	C-21	5/8" x 50' w/ Bulb Auger	x				
	62235	C-2	5/8" x 25' w/ Drop Head Auger	x				
	56787	C-21C	5/8" x 25' Inner Core w/ Drop Head Auger	x				
	89405	C-22	5/8" x 50' w/ Drop Head Auger	x				
3/4" CABLES	62245	C-4	3/4" x 25' w/ Male Coupling	x				
	62250	C-5	3/4" x 35' w/ Bulb Auger	x				
	62260	C-6	3/4" x 35' w/ Male Coupling	x				
	96037	C-61C	3/4" x 35' w/ Male Coupling	x				
1/2" CABLES	62265	C-7	1/2" x 7.5' Tight-Wind	x	x			
	62270	C-8	1/2" x 7.5' All Purpose Wind	x	x			
	25046	C-8PC	1/2" x 7.5' All Purpose Wind w/ Plastic Core	x	x			
	51317	C-9	1/2" x 7.5' Heavy Duty Wind	x	x			
3/8" CABLES	62275	C-10	3/8" x 15' All Purpose Wind w/ Plastic Core		x	x	x	x
	25036	C-10PC	3/8" x 15' All Purpose Wind		x	x	x	x
1 1/2" CABLES	62280	C-11	1 1/2" x 15' All Purpose Wind			x	x	x
	24226	C-11PC	1 1/2" x 15' All Purpose Wind w/ Plastic Core			x	x	x
	62285	C-12	1 1/2" x 15' Extra Heavy Duty Wind			x	x	x
	62295	C-14	1 1/2" x 15' Heavy Duty Wind			x	x	x
	62300	C-15	1 1/2" x 15' Extra Flexible Wind			x	x	x

DUFF
DELIVERS





SECTIONAL CABLE TOOLS

CATALOG NO.	MODEL NO.	DESCRIPTION	K50	K60	K1500	K1500SP	K1500G
62990	T-201	Straight 5" Auger	x				
62067	T-201A	Straight Flex Auger	x				
62995	T-202	Bulb Auger 1 1/4" OD	x				
63000	T-203	Bulb Auger 3/4" OD	x				
54837	T-204	"C" Cutter 1"	x				
63005	T-205	"C" Cutter 1 1/8"	x				
52812/ 52817/ 52822	T-230/ T-231/ T-232	H-D "C" Cutter 2 1/2" 2 3/4" 3"	x				
63010	T-206	Funnel Auger- 3"	x				
63015/63020/ 63025	T-207/ T-208/ T-209	Spiral Cutter 1 1/4" 1 1/2" 2"	x				
63030/ 63035/ 63040	T-210/ T-211/ T-212	Spade Cutter 1 1/4" 1 1/2" 1 3/4"	x				
63045/ 63050/ 63055	T-213/ T-214/ T-215	4-Blade Cutter 1 1/4" 1 1/2" 1 3/4"	x				
63060	T-216	Chain Knocker 2"	x				
63065	T-217	Drop Head 4" Long	x				
63220/63080/63070/63280	T-221/ T-220/ T-219/ T-218	Flue Brush 1 1/2" 2" 2 1/2" 3"	x				
55457	T-225	Straight Retrieving Auger	x				
62850	T-101	Straight Auger		x			
62855	T-102	Funnel Auger		x			
27642	T-125	Straight Retrieving Auger		x			
62860	T-103	Sawtooth Cutter 2 1/2"		x			
62865	T-104	"H" Cutter 2 1/2"		x			
62870	T-105	Grease Cutter 2 1/2"		x			
62875	T-106	Grease Cutter 3 1/2"		x			
62880	T-107	Spade Cutter 1 1/2"		x			
62915/ 62920/ 62925	T-109/ T-110/ T-111	Spiral Sawtooth Cutter 1 1/2", 2 1/4" & 3"		x			
62930	T-112	4-Blade Cutter 1 1/2"		x			
62935	T-113	4-Blade Cutter 3"		x			
62940	T-114	Chain Knocker		x			
98050	T-150	Three Blade 3", 4", 6"		x	x	x	x
98055	T-150-1	Sharktooth Cutter 3"		x	x	x	x
98060	T-150-2	Sharktooth Cutter 4"		x	x	x	x
62840	T-1	Straight Auger		x	x	x	x
61800	T-2	Heavy Duty Straight Auger		x	x	x	x
63105	T-3	Funnel Auger		x	x	x	x
61790	T-4	Heavy Duty Funnel Auger		x	x	x	x
63190	T-5	Straight Retrieving Auger		x	x	x	x
63195	T-6	Funnel Retrieving Auger		x	x	x	x
63200	T-7	Hook Auger		x	x	x	x
63205/ 63210 / 62845	T-8/ T-9/ T-10	Grease Cutter 2 1/2" 3 1/2" 4 1/2"		x	x	x	x
59480	T-11	"H" Cutter 2 1/2"		x	x	x	x
59485	T-12	"H" Cutter 3 1/2"		x	x	x	x
61970	T-13	Sawtooth Cutter 2 1/2"		x	x	x	x
61975	T-14	Sawtooth Cutter 3 1/2"		x	x	x	x
61770	T-15A	Expanding Cutter 4"-6"		x	x	x	x
61825	T-15B	Expanding Cutter 6"-8"		x	x	x	x
61960/ 61850/ 61855	T-16/ T-17/ T-18	Spiral Bar Cutter 4" 6" 8"		x	x	x	x
59625/ 63075/ 63085	T-21/ T-22/ T-23	Spiral Sawtooth Cutter 2 1/2" 3 1/2" 4 1/2"		x	x	x	x
59765/ 59770/ 59775/ 59780	T-24/ T-25/ T-26/ T-26A	4-Blade Cutter 2 1/2" 3 1/2" 4 1/2" 5 1/2"		x	x	x	x
63110/ 63115/ 63120	T-31/ T-32/ T-33	Chain Knocker 3"-4" 4"-6" 6"-8"		x	x	x	x
63145/ 63150/ 63155/ 63160/ 63165/ 63170/ 6315/ 63240/ 36180/ 36185	T-38/ T-39/ T-40/ T-41/ T-42/ T-43/ T-44/ T-45/ T-46/ T-47	Flue Brush 1 1/2" 2" 2 1/2" 3" 3 1/2" 4" 4 1/2" 5" 5 1/2" 6"		x	x	x	x
98030	T-50 (3 Blades- 3", 4" & 6")	Sharktooth Cutter 3" 4" 6"		x	x	x	x
98035	T-50-1	Sharktooth Cutter 3"		x	x	x	x
98040	T-50-2	Sharktooth Cutter 4"		x	x	x	x
98045	T-50-3	Sharktooth Cutter 6"		x	x	x	x

WATER JETTERS

APPLICATION CHART



KJ-1350



KJ-1750



KJ-2200



KJ-3100

APPLICATION	SINK LINES			
	FLOOR/SECONDARY DRAINS			
	LATERALS			MAIN LINES
LINE SIZE	1 1/4" - 4"	1 1/4" - 4"	1 1/4" - 6"	2" - 10"
MAXIMUM PRESSURE	1350 psi	1750 psi	2200 psi	3000 psi
FLOW	1.4 gpm	1.4 gpm	2.4 gpm	5.5 gpm
POWERED BY	Electric 15 amp.	Electric 20 amp.	Gas Engine	Gas Engine
HORSEPOWER	1.5 HP	2 HP	6.5 HP	16 HP
WEIGHT	68 Lbs.	73 Lbs.	63 Lbs.	275 lbs.

K-1350 on Model H-10 Cart



KJ-1350 – For 1 1/4" to 4" (32-100 mm) Drain Lines

- **Powerful:** Actual working pressure of 1350 psi and flow of 1.4 GPM for fast, effective cleaning of lines.
- **Pulse Action:** Activate the Model KJ-1350's pulse action to easily negotiate difficult bends and traps. The Model KJ-1350-2 has a second level of pulse.
- **Portable and Compact:** The optional Model H-10 Cart rolls the jetter and hose to the job site. Jetter and hose reel are easily removed from the cart in seconds for hard-to-reach drains or remote storage. The compact cart offers a retractable handle and swivel hose reel minimizing storage space. Optional adapter allows the Model KJ-1350 to be mounted on the upright Model H-30 Cart.
- **Electrical Requirement:** The 1.5 HP motor draws a maximum of 14 amps and can run on most standard 115 volt circuits.
- **Approved by CSA to CSA and UL Standards (115V only).**

MACHINE OPTIONS — 115V

CATALOG NO.	MODEL NO.	DESCRIPTION	WEIGHT	
			lb.	kg.
62587	KJ-1350	KJ-1350 Standard Jetter with Dual Pulse – H-21, H-22, and H-24 1/8" NPT Nozzles – 25' x 1/8" Sink Trap Hose – Nylon Storage Bag – Nozzle Cleaning Tool	70	31,7
62597	KJ-1350-C	Above With: – H-10 Cart – 100' x 3/16" Trap Hose	120	54,4
63107	KJ-1350-2	KJ-1350 Jetter with Dual Pulse – H-21, H-22, and H-24 1/8" NPT Nozzles – 50' x 1/8" Sink Trap Hose – Nylon Storage Bag – Nozzle Cleaning Tool	72	32,7
63112	KJ-1350-2C	Above With: – H-10 Cart – 100' x 3/16" Trap Hose	122	55,3

WATER JETTERS

KJ-1750 – For 1 1/4" to 4" (32-100 mm) Drain Lines

- **Powerful:** Actual working pressure of 1750 psi and flow of 1.4 GPM for fast, effective cleaning of lines.
- **Pulse Action:** Two levels of pulse are standard. Activate the Model KJ-1750's pulse action to easily negotiate difficult bends and traps.
- **Portable:** The optional Model H-30 Cart rolls the jetter and hose to the job site. The jetter is easily removed from the cart in seconds for hard-to-reach drains or for remote storage. Optional adapter allows the Model KJ-1750 to be mounted on the compact Model H-10 Cart.
- **Electrical Requirement:** The 2.0 HP motor draws a maximum of 17 amps which requires a 20 amp, 115 volt circuit.
- **Approved by CSA to CSA and UL Standards (115V only).**

MACHINE OPTIONS — 115V

CATA-LOG NO.	MODEL NO.	DESCRIPTION	WEIGHT	
			LB.	KG.
62687	KJ-1750	KJ-1750 Jetter with Dual Pulse – H-41, H-42, and H-44 1/8" NPT Nozzles – H-51 and H-52 1/4" NPT Nozzles – 50' x 1/8" Sink Trap Hose – Nylon Storage Bag – Nozzle Cleaning Tool	75	34
62697	KJ-1750- C	Above With – H-30 Cart – 110' x 1/4" Jet Hose	155	70,3
67332	KJ-1750-SC	62687 with – H-10 Cart – 100' x 3/16" Trap Hose	125	56,7

**KJ-1750
WATER JETTER**

Model KJ-1750-C
on Model H-30 Cart



KJ-2200 – For 1 1/4" to 6" (32-150 mm) Drain Lines

This jetter propels a highly flexible hose through 1 1/4" to 6" lines – blasting through sludge, soap and grease blockages. As you pull the hose back, it power scrubs the line flushing debris away, restoring drain lines to their full, free-flowing capacity.

- **Powerful:** Actual working pressure of 2200 psi and flow of 2.4 GPM for fast, effective cleaning of lines.
- **Easy to Use:** Thrust propels the hose down the line. You simply guide the hose into the drain.
- **Pulse Action:** Activate the Model KJ-2200's pulse action to easily negotiate difficult bends and traps.
- **Portable:** The optional Model H-30 cart rolls the jetter and hose to the job site. The jetter is easily removed from the cart in seconds for hard-to-reach drains, indoor applications or remote storage.
- **Convenient:** Standard equipment includes FV-1 foot valve. It makes remote or indoor operation simple. You control the jetting action at the drain while leaving the jetter outdoors.
- **Quality & Dependability:** Triplex pump with corrosion-resistant, forged brass head. Reduced number of fittings, hoses and parts minimizes leaks and down time, keeping you on the job.
- **Versatile:** Optional power washer package cleans cables, tools and other heavily soiled equipment.
- **New and improved 6.5 HP recoil start gasoline engine starts easily.** Features: ON/OFF switch; choke and throttle controls; easy access oil fill and dip stick.
- **Approved by CSA to CSA and UL Standards (115V only)**

CATA-LOG NO.	MODEL NO.	DESCRIPTION	WEIGHT	
			LB.	KG.
63877	KJ-2200	KJ-2200 Jetter with Pulse – H-61, H-62, and H-64 1/4" NPT Nozzles – H-71 and H-72 1/4" NPT Nozzles – 75' x 3/16" Sink Trap Hose – FV-1 Foot Valve – Nozzle Cleaning Tool – H-1235 Wash Wand Hose 1/2" x 35'	65	29,5
63882	KJ-2200- C	Above With – H-30 Cart – 110' x 1/4" Jet Hose	145	65,8

**KJ-2200
WATER JETTER**

Model KJ-2200-C

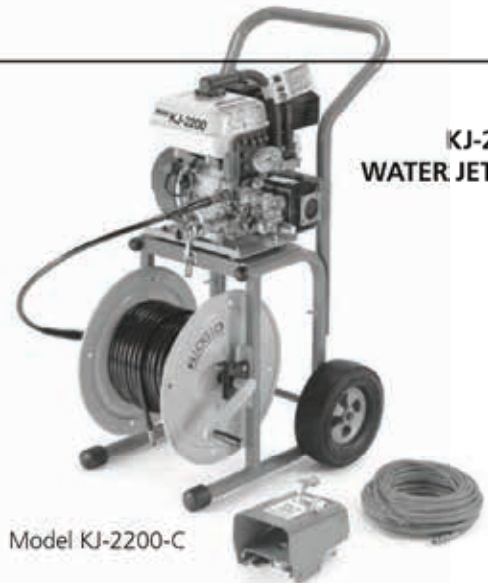

WATER JETTERS

KJ-3100 – For 2" to 10" (50-250 mm) Drain Lines

The RIDGID Model KJ-3100 portable water jetter gives you 3000 psi actual working pressure to handle large commercial and industrial applications. This jetter propels a highly flexible and lightweight hose through 2" to 10" lines – blasting through sludge, soap, grease, and sediment blockages. As you pull the hose back, it power scrubs the line flushing debris away and restoring drain lines to their full, free-flowing capacity – all without the use of harmful chemicals.

- **Powerful:** Actual working pressure of 3000 psi and flow of 5.5 GPM for fast, effective cleaning of lines.
- **Lightweight Hose:** Hose with nylon braid provides significant weight reduction and increased flexibility – all without reducing strength. Allows the thrust to propel the hose further down the line.
- **Complete:** With the Model KJ-3100's removable hose reel, there is no need to purchase expensive portable hose reels. Standard packages come equipped to handle indoor and remote applications.
- **Convenient:** Completely remove the hose reel to ease loading onto service trucks. Simply rotate the hose reel forward to gain full access to the engine's gas tank and air filter.
- **Maneuverable:** In the heavy-duty 3000 psi jetter category, the RIDGID KJ-3100 is one of the most maneuverable jetters on the market. The unit, on its unique two-wheeled cart, easily fits through standard size doors and can negotiate tight turns with the greatest of ease.
- **Pulse Action:** Activate the Model KJ-3100's pulse action to easily negotiate difficult bends and traps.
- **Quality & Dependability:** Triplex pump with corrosion-resistant, forged brass head. Gear reducer allows pump to run at slower (optimal) speed. Reduced number of fittings, hoses and parts minimizes leaks and downtime – keeping you on the job.
- **Versatile:** Power wash package and chemical injector system cleans cables, tools, and other heavily soiled equipment.
- **Quick Start:** 16 HP recoil start gasoline engine starts easily. Features: ON/OFF switch; fuel shutoff; choke and throttle controls; easy access oil fill and dip stick.
- **Approved by CSA to CSA and UL Standards (115V only).**



**KJ-3100
WATER JETTER**



Model KJ-3100
with hose reel removed

CATA-LOG NO.	MODEL NO.	DESCRIPTION	WEIGHT	
			LB.	KG.
37413	KJ-3100	KJ-3100 Jetter with Pulse – H-111 and H-112 1/4" NPT Nozzles – RR3000 Root Ranger Nozzle – H-38 Hose Reel with 200' x 3/8" ID Jet	272	125
		Hose – 50' x 3/8" ID JetWash Hose – FV-1 Foot Valve – Nozzle Cleaning Tool – HW-30 Wash Wand	214 w/o hose reel	97 w/o hose reel

RIDGID FACTS:

In 1936, the world's first sectional drain cleaning machines are introduced by Kollmann which is later acquired by RIDGID in 1967.

RIDGID introduced Water Jetters in 1991.



RIDGID

INSPECTION & DIAGNOSTIC TOOLS

The hardest problems to solve are the hardest ones to see.

RIDGID® diagnostic inspection tools help you locate, diagnose, and solve problems quickly and accurately.



SEESNAKE® NANOREEL INSPECTION CAMERA #40008

Designed for long run small diameter inspection jobs including boiler tubes, supply lines, sprinkler systems and more. Quickly inspect lines up to 85' long from 3/4" to 2" in diameter.

- Tight turn radius
- Lightweight and compact
- Compatible with multiple monitors



SEESNAKE® NANOREEL INSPECTION CAMERA #35183

Quickly inspect lines up to 100' from 1 1/4" to 4" in diameter.

- Lightweight and compact
- Compatible with multiple monitors
- Durable construction



SEESNAKE® CS10 DIGITAL RECORDING MONITOR #39328

Now it's easier than ever to record, capture and report jobsite findings. Transfer snapshots and video to a thumb drive with the push of a button.

- 12.1" LCD display
- USB thumb drive recording



INSPECTION CAMERAS

RIDGID inspection cameras allow you to get the perfect view behind walls, in pumps, near leaks and around other hard-to-reach spaces. All feature a comfortable pistol grip, four bright LED camera heads and waterproof design.

	Micro CA-25 View Only Camera	Micro CA-100 View Only Camera	Micro CA-300 Recording Camera
Screen Size	2.4"	3.5"	3.5"
Camera Diameter	0.7"	0.7" & 0.23"	0.7" & 0.23"
Cable Length	Fixed 3'	3-30'	3-30'
SD Card & USB Port	No	No	Yes
Pan & Zoom	No	No	2X Digital Zoom
Catalog Number	40043	36738	37888



MICRO CD-100 COMBUSTIBLE GAS DETECTOR #36163

Simple, quick readings to identify the presence of combustible gases. Ensure proper gas line installations, check for maintenance and repair needs or quickly pinpoint gas leaks.



MICRO LM-100 LASER DISTANCE METER #36158

Measure distances for project bidding, identify trouble spots down the line, and quickly determine spacing for code compliance with the push of a button.







MICRO IR -100 NON-CONTACT INFRARED THERMOMETER #36153





Get simple, quick and accurate surface temperatures at the push of a button. Diagnose heating and ventilation problems, quickly check fuses or circuit breakers without contact.

LOCATING EQUIPMENT

RIDGID® Receivers – RIDGID locating receivers feature an easy-to-use visual mapping display that allows you to locate utility lines and sondes/beacons with confidence. Use with a SeeSnake camera equipped with a sonde transmitter to locate the camera head during an inspection or use with a line transmitter to find buried utilities.

	 22163	 21893	 96967	 19238
Omni-Directional Mapping Display	Yes	Yes	Yes	Yes
User-Defined Frequencies	Yes - All Available	Yes up to 35 kHz	No	No
Number of Active Line Trace Frequencies	All up to 490 kHz	All up to 35 kHz	7	3
Sonde Frequencies	All up to 490 kHz	All up to 35 kHz	7	4
Passive Search	Omni-Seek (searches all passive bands at once)	Omni-Seek (searches all passive bands at once)	50/60 Hz	50/60 Hz
Depth	Continuous	Continuous	Continuous	Push Button
Weight w/batteries	5.1 lb.	3.5 lb.	5.1 lb.	3 lb.

RIDGID Transmitters – Accurately trace buried utilities by applying a signal with a RIDGID Line Transmitter. All transmitters have multiple frequency options and are capable of applying a signal by direct connection and induction. Powerful 5W and 10W transmitters apply a strong signal making for easier locates.

	 26168	 21903	 14818	 21898	 20168
Max Power Output	5W	10W	10W	5W	5W
Digital Display	Yes	Yes	No	No	No
Line Trace Frequencies	All up to 490 kHz	5*	6	4	4
Inductive Frequencies	2	5*	6	3	4
Simultaneous Transmit 2 Line Frequencies	No	No	No	Yes	Yes
Weight w/batteries	11.1 lb.	9 lb.	9 lb.	2.5 lb.	2.5 lb.

* The ST-510 Transmitter can also be set to frequencies used by other manufacturers'

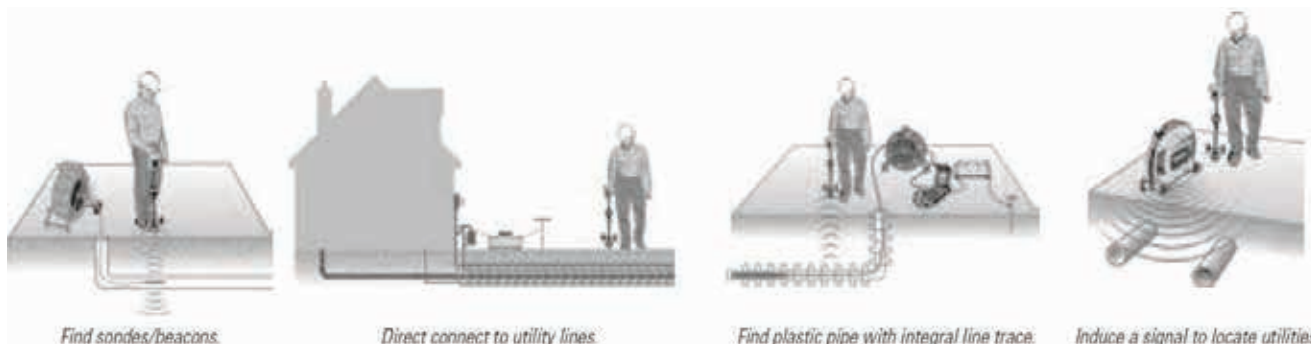

D.I.Y. DRAIN CLEANERS



Steel Drum Spin-Thru



Power Steel Spin-Thru



3J CLOSET AUGER



Plastic Spin-Thru



Power Plastic Spin-Thru



Clog Chaser



Power Clog Chaser

CATALOG NO.

DESCRIPTION

R-25SM	Steel Drum Spin-Thru w/25' x 1/4"
R-P-25SM	Power Steel Spin-Thru w/25' x 1/4"
R-25PL	Plastic Spin-Thru w/25' x 1/4"
R-C-25PL	Power Plastic Spin-Thru w/25' x 1/4"
R-15CL	Clog Chaser w/15' x 1/4"
R-C-15CL	Power Clog Chaser w/15' x 1/4"
LR15PQH	15' x 1/4" Replacement Cable
LR25PQH	25' x 1/4" Replacement Cable
3J	3 ft. Hollow Cable Auger



GENERAL PIPE CLEANING — KINETIC WATER RAM



CATALOG NO.

DESCRIPTION

KINETIC WATER RAM BASIC UNIT AND PACKAGES	
KR-A	Basic Unit: Caulking Hose, 4" Rubber Cone, 5 Rubber Plugs
KR-A-WC	Basic Unit + Case
KR-C-WC	Basic Unit + KR-CA Toilet Attachment, Case
KR-D-WC	Same as KR-C-WC, less Caulking Hose, + 6" Rubber Cone, 4 Expansion Plugs, Check Valve, Extension Hose, Water Supply Hose, Faucet Adapter, Case

KINETIC WATER RAM ACCESSORIES & PARTS							
KR-CC	Carrying Case	10	\$	49.85	143450	G-44	Caulking Hose
KR-RK	Ram Repair Kit	0	\$	23.60	143460	G-45	Water Supply Hose 48"
KR-CA	Toilet Attachment	1	\$	33.65	143470	G-46	Faucet Adapter
G-30	Pressure Gauge	0.5	\$	22.35	143490	G-48	5 Rubber Plugs
G-43-4	4" Rubber Cone	0.5	\$	13.95	142700	G-52	22" Extension Hose
G-43-6	6" Rubber Cone	0.5	\$	17.55	142020	1-1/2EX	1-1/2" Expansion Plug
KR-ACC	Ram Accessory Kit	9	\$	123.40	142030	2EX	2" Expansion Plug
G-CVK	Ck. Valve Assy. Kit: G45, 46, 55	1	\$	31.90	142040	3EX	3" Expansion Plug
					142050	4EX	4" Expansion Plug



SUPERVEE CUTTER SET

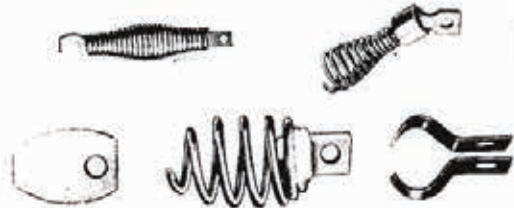

OEM NO.	FIG. NO.	PRICE
HE-CS	15529	



OPERATORS GLOVE

DESCR.	FIG. NO.	PRICE
Left Hand	19094	
Right Hand	19095	

DUFF DIFFERS

HEAVY DUTY AUGERS

1 5/32" OD DOUBLE LAYER FLEXICORE CONSTRUCTION



DOWNHEAD



DOWNHEAD			
DESCR.	OEM NO.	FIG. NO.	PRICE
3 ft flexicore	3FL-DH	15798	
6 ft teletube flexicore	T6FL-DH	20245	

REGULAR HEAD



REGULAR HEAD			
DESCR.	OEM NO.	FIG. NO.	PRICE
3 ft flexicore	3FL	15804	
6 ft teletube flexicore	T6FL	20246	

est. 1947

DUFF^{co.}

When you need it now... or don't know how

OVER
65
YEARS OF
SERVICE

SPEEDROOTER 90

1/2 HP capacity motor, large drum, ground fault interrupter, water-proof air foot switch, leather gloves, one 100 ft x 5/8" cable and cutter set. Boxed wt. 220 LBS.

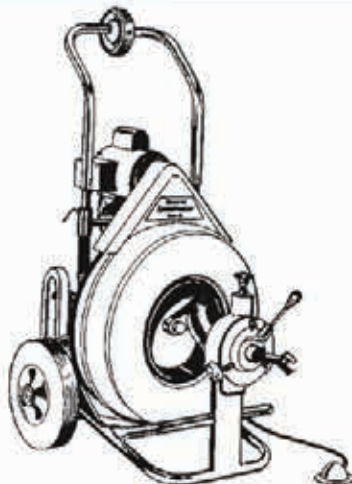

OEM NO.	FIG. NO.
GPS90E	15694

SNAKE OIL

SNAKE-OIL protects your snakes better than common lubricants. Its special rust inhibitor cuts through moisture and replaces it with a rust-resistant coating. In addition, the lemon-scented SNAKE-OIL give your equipment a fresh, clean smell.



SIZE	FIG. NO.
QT	15593
GAL	15599

GENERAL WIRE DRAIN CLEANERS

MINIROOTER

- GMRB - With 75 ft x 3/8" cable (75 EM2) and minirooter cutter set.
- GMRC - with 50 ft. x 1/2" cable (50EM3) and minirooter cutter set.
- J50 - J-drum with 50 ft x 1/4" cable (50HE) installed (no machine)
- J50A - J-drum with 50 ft x 5/16" cable (50HE-A) installed (no machine).

ACCESSORIES:

- MR200 - Drum for 3/8" or 1/2" cables.
- MR250 - J-drum for 1/4" or 5/16" cables.
- MR280 - Dual drum for small diameter cables.

REPLACEMENT CABLES:

- | | | | |
|----------|-------------|--------|------------|
| 50HE1: | 1/4" X 50' | 75EM2: | 3/8" X 75' |
| 50HE1-A: | 5/16" X 50' | 50EM3: | 1/2" X 50' |
| 50EM2: | 3/8" X 50' | 75EM3: | 1/2" X 75' |

MR-W - Mini rooter dolly.

General Wire Spring Company

OEM NO.	FIG. NO.	PRICE
GMRB	15558	
GMRC	15559	
J50	DCGJ50	
J50A	DCGJ50A	
MR200	15562	
MR250	DCGMR250	
MR280	DCGMR280	
50HE1	15538	
50HE1A	15542	
50EM2	DCG50EM2	
75EM2	39065	
50EM3	30865	
75EM3	37793	
MRW	DCGMRW	

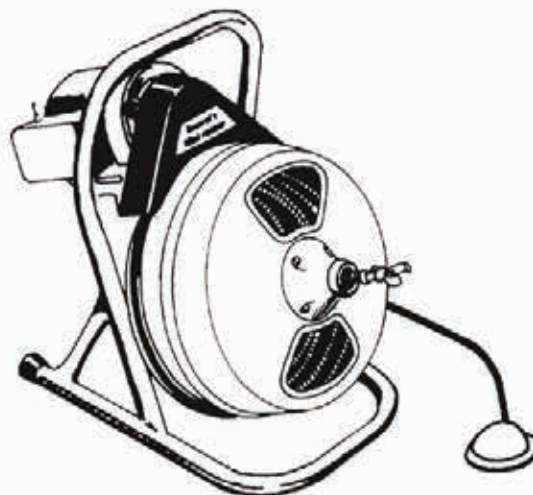

DUAL DRUM
(MR-280)

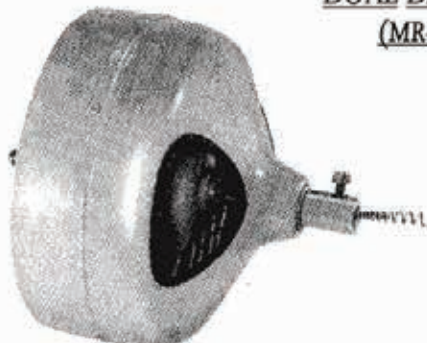

J DRUM
(MR-250)

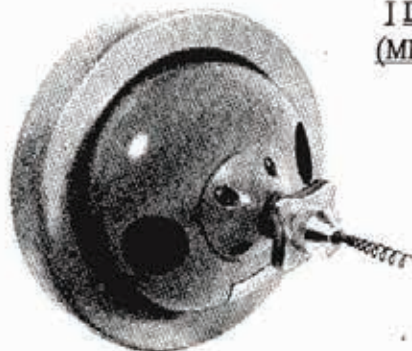

DOLLY

GENERAL WIRE DRAIN CLEANERS



RODRUNNER:

GRDGF- With ten flexichain sections with "G" connectors, and RCDS-G cutter set.

GRDGP - With ten proflex sections with "G" connectors, and RDCS-G cutter set.

GRDLF - With ten 10LF flexichain flexible sections with "L" connectors, and RDCS-L cutter set.

GRDLP - with ten 10LP proflex sections with "L" connectors and RDCS-L cutter set.

RDCS-G Rodrunner cutter set with "G" connectors includes: Spear head, Hook Auger, 2" U Cutter, 3" Heavy Duty Side Cutter, 3" Heavy duty Saw Blade, 4" Rotary Saw Blade, Large Retrieving Tool, Coupling Wrench.

RDCS-L Rodrunner cutter set with "L" connectors includes: Spear Head, Hook Auger, 2" U Cutter, 3" Heavy Duty Side cutter, 3" Heavy Duty Saw Blade, 4" Rotary Saw Blade, Large Retrieving Tool, Coupling Wrench.

General Wire Spring Company

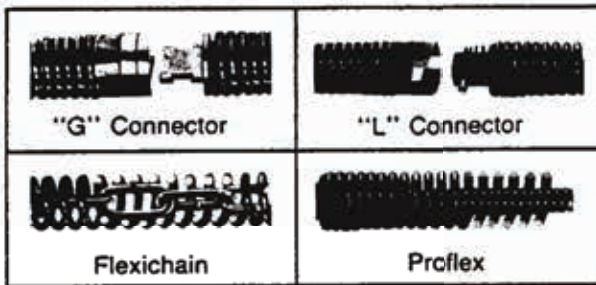

OEM NO.	FIG. NO.	PRICE
G-RD-GF	15761	
G-RD-GP	15763	
G-RD-LF	15765	
G-RD-LP	15766	
RDCS-G	15767	
RDCS-L	15769	

CUTTER SETS

RSHD10
Spear Head

R2UC10 -
2" U-Cutter
for cutting
and scrap-
ing.

R3UC10 -
3" U-Cutter
for cutting
and scrap-
ing.

RRTR10 -
Corkscrew
retrieving
tool for
removing
loose
objects.

RHA10 - Hook Auger
for breaking up stop-
page and retrieving.

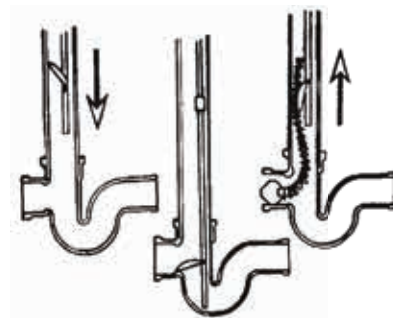

TRAP SPOON

Guides tool into pipe. Ideal for lawn or curb traps.

OEM NO.	FIG. NO.	PRICE
59440	25035	

GENERAL PIPE CLEANING — SUPER VEE

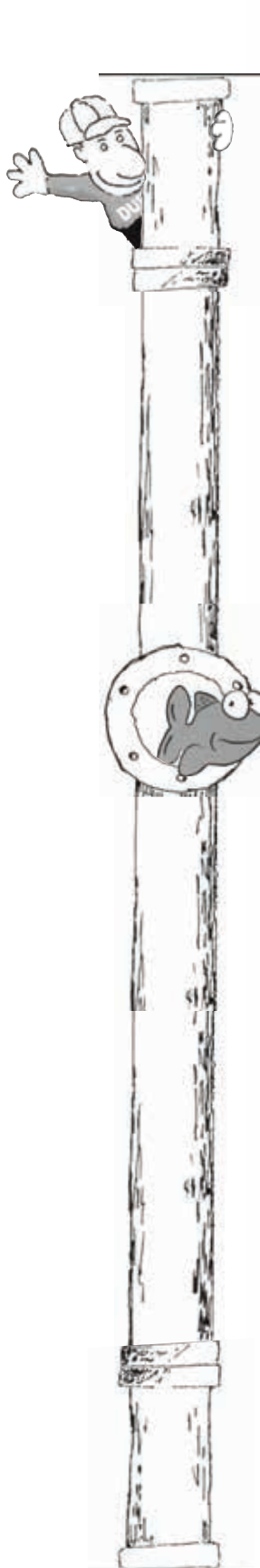

CATALOG NO.

DESCRIPTION

SUPER-VEE BASIC UNIT AND PACKAGES	
SV	Basic Unit: Slide-Action Chuck, Variable Speed Motor w/Rev Switch, Plastic Cartridge
SV-A-WC	Basic Unit + 25HE1 (25' x 1/4") & 25HE2 (25' x 3/8") Cables, HECS Cutter Set, Extra Cartridge, Case
SV-B-WC	Basic Unit + 25HE1 (25' x 1/4") & 35HE2 (35' x 3/8") Cables, HECS Cutter Set, Extra Cartridge, Case
SV-C-WC	Basic Unit + 50HE1 (50' x 1/4") & 35HE2 (35' x 3/8") Cables, HECS Cutter Set, Extra Cartridge, Case
SV-D-WC	Basic Unit + 25HE1-A (25' x 5/16") Cable, Case
SV-F-WC	Basic Unit + 25HE1 (25' x 1/4") Cable, Case

SUPER-VEE CUTTERS, ACCESSORIES, PARTS, CABLES	
HECS	Handyelectric Cutter Set (AH, FAH, 1-1/4SCB, BG, DHBG)
MCC	Carrying Case
PC	Plastic Cartridge
CAA	Closet Auger Attachment
SV-25	Cable Grippers
SV-31-3	Trigger Switch for Skil #6355-GWS
HST	Handy-Stand
25HE1	1/4" x 25' with EL Basin Plug Head
6-25HE1	(6) 1/4" x 25' with EL Basin Plug Head
50HE1	1/4" x 50' with EL Basin Plug Head
25HE1-DH	1/4" x 25' with Down Head
6-25HE1-DH	1/4" x 25' with Down Head
50HE1-DH	1/4" x 50' with Down Head
25HE1-DDH	1/4" x 25' with Double Down Head
50HE1-DDH	1/4" x 50' with Double Down Head
25HE1-A	5/16" x 25' with EL Basin Plug Head
6-25HE1-A	(6) 5/16" x 25' with EL Basin Plug Head
50HE1-A	5/16" x 50' with EL Basin Plug Head
25HE1-A-DH	5/16" x 25' with Down Head
50HE1-A-DH	5/16" x 50' with Down Head
25HE1-AC	5/16" x 25' with Female Connector
50HE1-AC	5/16" x 50' with Female Connector
25HE2	3/8" x 25' with Female Connector
3-25HE2	(3) 3/8" x 25' with Female Connector
35HE2	3/8" x 35' with Female Connector
3-35HE2	(3) 3/8" x 35' with Female Connector

For additional information call: 610-275-4453 or Fax: 610-279-6299
Please call for current prices.

GENERAL PIPE CLEANING — POWER VEE



CATALOG NO.

DESCRIPTION

POWER-VEE BASIC UNIT AND PACKAGES	
PV	Basic Unit: Power Cable Feed, Variable Speed Motor w/Rev Switch, Plastic Cartridge
PV-A-WC	Basic Unit + 25HE1-DH (25' x 1/4") & 25HE2 (25' x 3/8") Cables, HECS Cutter Set, Extra Cartridge, Case
PV-B-WC	Basic Unit + 25HE1-DH (25' x 1/4") & 35HE2 (35' x 3/8") Cables, HECS Cutter Set, Extra Cartridge, Case
PV-C-WC	Basic Unit + 50HE1-DH (50' x 1/4") & 35HE2 (35' x 3/8") Cables, HECS Cutter Set, Extra Cartridge, Case
PV-D-WC	Basic Unit + 25HE1-A-DH (25' x 5/16") Cable, Case
PV-F-WC	Basic Unit + 25HE1-DH (25' x 1/4") Cable, Case

POWER-VEE CUTTERS, ACCESSORIES, PARTS	
HECS	Handyelectric Cutter Set (AH, FAH, 1-1/4SCB, BG, DHBG)
PV-31-3	Trigger Switch for Skil #6355-GWS
PV-31-V-S	Trigger Switch for Skil #81596
PV-N-2	Complete Power-Vee Front Assembly
PV-703-2	Set of Roller Assemblies for Power Cable Feed

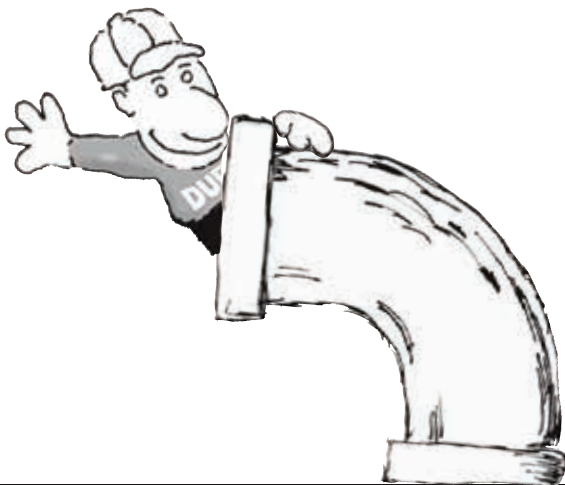
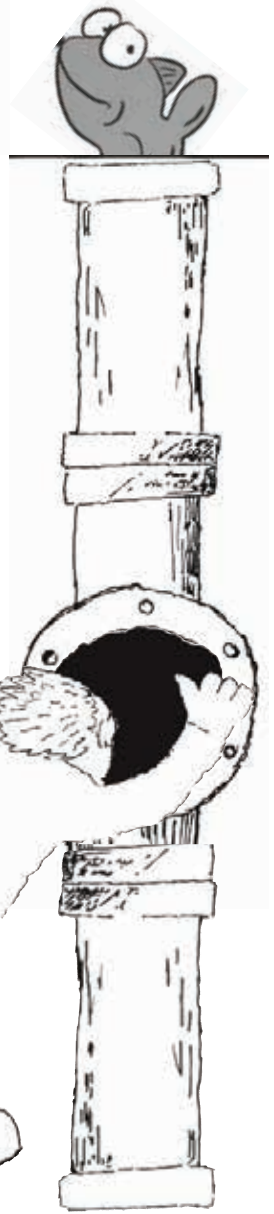

GENERAL PIPE CLEANING — HANDYLECTRIC, DRAIN ROOTER

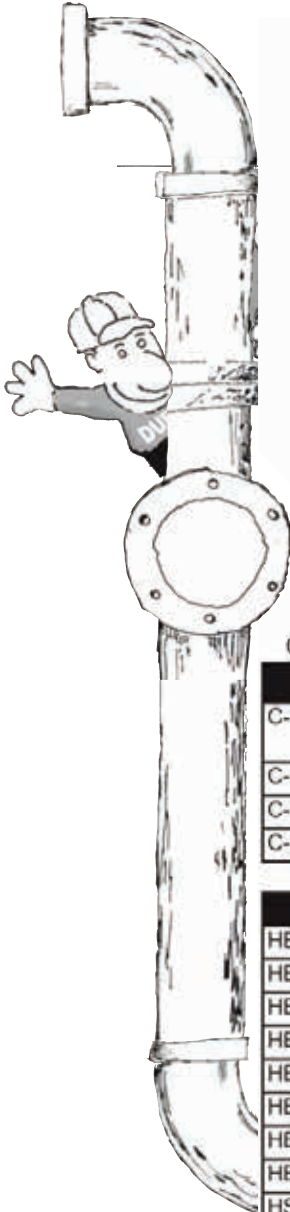

HANDYLECTRIC



DRAIN-ROOTER



DRAIN-ROOTER PH

CATALOG NO.	DESCRIPTION
HANDYLECTRIC BASIC UNIT AND PACKAGES	
C-HE	Basic Unit: Patented Collet Chuck w/Quick Tightening Handle & Variable Speed Motor w/Rev Switch
C-HE-A-WC	Basic Unit + 25HE1 (25' x 1/4") & 25HE2 (25' x 3/8") Cables, HECS Cutter Set. Case
C-HE-D-WC	Basic Unit + 25HE1-A (25' x 5/16") Cable, Case
C-HE-F-WC	Base Unit + 25HE1 (25' x 1/4") Cable, Case
HANDYLECTRIC ACCESSORIES, PARTS	
HE-25-28-A	Jacobs Chuck Assembly
HE-25-28-B	Collet Chuck Assembly
HE-31-3	Trigger Switch For Skil #6355-GWS
HE-31-V-S	Trigger Switch For Skil #81596
HE-51-5	Container Front for Jacobs Chuck
HE-51-4	Container Front for Collet Chuck
HE-02-2	Container Back
HE-03-1	Grip Shield
HST	Handy-Stand
MK-HST	Handy-Stand Modification Kit for Skil Motor #81596
DRAIN-ROOTER BASIC UNIT AND PACKAGES	
DR	Basic Unit: Drum, Variable Speed Motor w/Rev. Switch, Water-Proof Air Foot Switch
DR-B	Basic Unit + 50HE1-AC (50' x 5/16") Cable, HECS Cutter Set
DR-C	Basic Unit + 35HE2 (35' x 3/8") Cable, HECS Cutter Set
DR-F	Basic Unit + 25HE1 (25' x 1/4") Cable
DRAIN-ROOTER PH BASIC UNIT AND PACKAGES	
PH-DR	Basic Unit: Power Cable Feed, 4 ft. Guide Hose, Drum, Variable Speed Motor w/Rev. Switch, Water-Proof Air Foot Switch, Plastic Cartridge
PH-DR-A	Basic Unit + 50HE1-A-DH (50' x 5/16") Cable
PH-DR-B	Basic Unit + 50HE1-AC (50' x 5/16") Cable, HECS Cutter Set
PH-DR-C	Basic Unit + 35HE2 (35' x 3/8") Cable, HECS Cutter Set
PH-DR-D	Basic Unit + 50HE1-DH (50' x 1/4") Cable

GENERAL PIPE CLEANING — SEWEROOTER T-3



**General
PIPE CLEANERS**



CATALOG NO.

DESCRIPTION

SEWEROOTER T-3 BASIC UNIT AND PACKAGES	
P-T3	Basic Unit: 1/3 hp Capacitor Motor w/Rev. Switch, Power Cable Feed, Drum, Water-Proof Air Foot Switch, 20 ft. Power Cord w/GFI, Leather Gloves
P-T3-A	Basic Unit + 75EM2 (75' x 3/8") Cable, Power Cable Feed, Guide Tube, JRCS Cutter Set
P-T3-C	Basic Unit + 75EM3 (75' x 1/2") Cable, Power Cable Feed, Guide Tube, JRCS Cutter Set
P-T3-D	Basic Unit + 100EM3 (100' x 1/2") Cable, Power Cable Feed, Guide Tube, JRCS Cutter Set

Order WITHOUT Power Cable Feed: delete prefix "P", as T3-A

SEWEROOTER T-3 CUTTERS, ACCESSORIES, PARTS, CABLES	
JRCS	Junior Cutter Set (LE-1, AH, 1-1/2UC, 2SCB, 3SCB, 4SCB, 3RSB, RTR-1)
T3-401-2	Drum for 1/2" or 3/8" Cables
PO-JR	Junior Power Cable Feed & Guide Tube
T3-GT	Guide Tube for Junior (Cannot be used without Power Cable Feed)
GTE	Guide Tube Extension
GFI-20	Ground Fault Circuit Interrupter with 20 ft. Power Cord
LG	Heavy Duty Leather Gloves
SIG	Splash/Impact Goggles
T3-610-B	Foot Pedal with Hose
T3-610-E	Power Switch Diaphragm
T3-610-G	Reverse Switch Only
PO-JR-703	Set of Rollers for Junior Power Cable Feed
25EM2	3/8" x 25' with Male & Female Connectors
50EM2	3/8" x 50' with Male & Female Connectors
75EM2	3/8" x 75' with Male & Female Connectors
100EM2	3/8" x 100' with Male & Female Connectors
25EM3	1/2" x 25' with Male & Female Connectors
50EM3	1/2" x 50' with Male & Female Connectors
75EM3	1/2" x 75' with Male & Female Connectors
100EM3	1/2" x 100' with Male & Female Connectors

**DUFF
DELIVERS**



GENERAL PIPE CLEANING — SPEEDROOTER 92



CATALOG NO.

DESCRIPTION

SPEEDROOTER 92 BASIC UNIT AND PACKAGES	
P-S92	Basic Unit: 1/2 hp Capacitor Motor, Power Cable Feed, S92-450 Large Drum, Water-Proof Air Foot Switch, 20 ft. Power Cord w/GFI, Leather Gloves
P-S92-A	Basic Unit + 100EM5 (100' x 3/4") Cable, 100EM3 (100' x 1/2") Cable Installed in Small Drum, Power Cable Feed, Guide Tube, COCS Cutter Set
P-S92-C	Basic Unit + 100EM5 (100' x 3/4") Cable, Power Cable Feed, Guide Tube, SRCS Cutter Set
P-S92-E	Basic Unit + 100EM4 (100' x 5/8") Cable, Power Cable Feed, Guide Tube, SRCS Cutter Set

To order WITHOUT Power Cable Feed: delete prefix "P", as S92-A.

To order 3/4 hp Motor: add prefix "3/4HP", as 3/4HP-P-92-A

SPEEDROOTER 92 CUTTERS, ACCESSORIES, PARTS, CABLES	
SRCS	Senior Cutter Set (LE-3, SHD, 3SCB, 4SCB, 2UC, 3HDB, 4RSB, RTR-2)
COCS	Combination Cutter Set (SRCS + LE-1, AH, 1-1/2UC, 2SCB, RTR-1)
S92-450	Large Drum (18") for 3/4" & 5/8" Cables
S92-400	Small Drum (15") for 1/2" Cables
PO-S92	Speedroooter Power Cable Feed & Guide Tube
LG	Heavy Duty Leather Gloves
SIG	Splash/Impact Goggles
S92-GT	Guide Tube for Speedroooter (Cannot be used without Power Cable Feed.)
GTE	Guide Tube Extension
TB-S92	Tool Box
GFI-20	Ground Fault Circuit Interrupter with 20 ft. Power Cord
S92-605-B	Foot Pedal with Hose
S92-605-E	Power Switch Diaphragm
S92-605-G	Reverse Switch Only
PO-703	Set of Rollers for Power Cable Feed
25EM5	3/4" X 25' with Male & Female Connectors
50EM5	3/4" x 50' with Male & Female Connectors
75EM5	3/4" x 75' with Male & Female Connectors
100EM5	3/4" x 100' with Male & Female Connectors
25EM4	5/8" x 25' with Male & Female Connectors
50EM4	5/8" x 50' with Male & Female Connectors
75EM4	5/8" x 75' with Male & Female Connectors
100EM4	5/8" x 100' with Male & Female Connectors
25EM3	1/2" x 25' with Male & Female Connectors
50EM3	1/2" x 50' with Male & Female Connectors
75EM3	1/2" x 75' with Male & Female Connectors
100EM3	1/2" x 100' with Male & Female Connectors

ELECTRICAL TESTERS AND TOOLS

AMPROBE LCD Digital Readout



Voltage sensor with audio and visual indicators. No need to make contact for reading!

FIG. NO.
50713



Analog Multimeter

This analog multimeter offers the key functions required in a multi tester. AC /DC voltage, resistance, DC current, decibels, and a battery check are easily read on the 3-color mirrored scale. Recessed lead connections and fuse protection provide important safety features.

FIG. NO.
64154

Handy combination HI-voltage tester and pocket screwdriver with a range of 90 to 250V AC/DC, clips on shirt pocket.

FIG. NO.
50715



Detects AC voltage from 100 to 440 VAC

FIG. NO.
50714

It would be shocking if **DUFF** Didn't have the electrical tool you need.



PVC ELECTRICAL TAPE - A high quality all-purpose black vinyl 7 1/2 mil. electrical tape. 3/4" x 60".

FIG. NO.
15332

4 way voltage tester with indicator lights for 110, 220, 277 & 480V AC/DC and features flexible leads and pocket clip.

FIG. NO.
50717



AUTOMOTIVE BOOSTER CABLES - -

All premium grade cables come with heavy duty vinyl clad clamps with gator-jaws. Heavy insulated, copper stranded wire. Tangle free cables.



FIG. NO.
43542



Jumper leads are 36' in length with alligator clips & plastic insulators to cover metal clips.

FIG. NO.
50718

**INDUSTRIAL
FLASHLIGHTS**



Standard flashlight



Flashlight with magnet

FIG. NO.	TYPE
35356	Standard w/ magnet



Flashlight with continuity tester

FIG. NO.	PRICE
39284	

EXTENSION CORDS



Outdoor extension cord set. Vinyl cover will not mar floors or walls and resists deterioration. Three conductor, grounded cord sets - UL (USA) - round - meets OSHA requirements. Double insulation around each conductor, plus a heavy outer jacket in mar-proof orange vinyl. Heavy duty molded on plastic male and female plugs.

GA/COND	LGTH/FT	125 V RATING	FIG. NO.	PRICE
14/3	25	20A	43559	
14/3	50	20A	16195	
14/3	100	15A	44766	

TROUBLE LIGHTS



Trouble lights - UL (USA) - Three conductor with extension outlets. Deluxe trouble light with grounded three wire outlet on easy grip handle. Socket housings are designed to stay cool even when short neck bulbs are used. Ground metal bulb cage and hook. On/Off switch.

GA/COND	LGTH/FT	125 V RATING	FIG. NO.	PRICE
16/3	25	13A	43560	
16/3	50	13A	16197	

ROUGH SERVICE BULBS



Rough Service Light Bulbs - brass base to eliminate corrosion in the socket, making replacement easier. Designed to burn for 5,000 hours - most competitors offer a 2,000 hour bulb at comparable pricing.

FIG. NO.	PRICE
46946	

**See page 695 (MULTI-FAMILY)
for Batteries!**



How to Order

Submit your order online
or
email info@duffco.com

Be sure to include
product numbers
descriptions
quantities

Don't forget to include your name!

DUFF SUPPLY COMPANY

WATER TREATMENT EQUIPMENT - PUMPS - PLUMBING - HEATING - INDUSTRIAL SUPPLIES - PUMPS
 STEAM SPECIALTIES - PIPE - VALVES - FITTINGS - SOFTENERS - FILTERS
 201 EAST LAFAYETTE STREET, P.O. BOX 618, NORRISTOWN, PA 19401
 PHONE: 610-275-4453 FAX: 610-279-6299



SOLD TO:

SHIP TO:

YOUR NAME: _____ PURCHASE ORDER NO. _____

TODAY'S DATE: _____ REQUIRED DATE: _____

QTY	FIG. NO.	DESCRIPTION	PRICE/EA	TOTAL



TERMS: NET - 10TH OF MONTH FOLLOWING PURCHASE
 WE WILL PREPAY AND ADD FREIGHT FOR ALL ORDERS SHIPPED UPS OR COMMON CARRIER

All accounts are to be paid in full to Duff Supply Company monthly by the tenth (10th) day of the month following invoice date, a 1% service charge and a 1% interest charge will be made on any balance open at the end of the month following invoice, and in the event that legal action or lien be undertaken, or the service of a collection agency are used to collect this account, the customer shall pay all expenses incurred by Duff Supply Company, such as, but not limited to, costs and collection, legal and lien fees.

QTY	FIG. NO.	DESCRIPTION	PRICE/EA	TOTAL



*Thank You
for your business!*



Contact name _____ Contact Date _____



DUFF COMPANY

201 East Lafayette Street
Norristown, PA 19401



Phone: **610-275-4453** Fax: **610-279-6761**

Legal Name _____

Name in which business is conducted _____

Billing Address _____

City _____ State _____ Zip _____

Purchasing Phone _____ A/P Phone _____ Fax _____



Principal's Name _____

Principal's Address _____

City _____ State _____ Zip _____

Phone (Office) _____ (Cell) _____ E-mail address _____

Website address (If applicable) _____

Primary Contact _____ Title _____



SHIPPING ADDRESS - IF DIFFERENT

Shipping Address _____ Phone _____

City _____ State _____ Zip _____

Tax Exempt Number _____ Provide a copy of Certificate. We CAN NOT set up a Tax Exempt Account without certification.



TYPE OF BUSINESS

Plumbing _____ Pumps _____ Heating _____ Municipality _____ Hotel or Apts. _____ Well Drilling _____
Hospital _____ Factory (OEM) _____ Factory (Mtn) _____ Office Building _____ Shopping Center _____
Golf Course _____ Water Treatment _____ Environmental _____ Other (Please name) _____

Have you been contacted by one of our salesman? _____ Name _____

If YES, please explain _____

Name of person authorized to pick up _____

D&B Rating _____ Check one: Corporation _____ Partnership _____ Individual Proprietor _____

If division of another company, name parent company and relationship _____

DUFF COMPANY

201 East Lafayette Street, Norristown, PA 19401

TRADE REFERENCES

Name _____ Type of business _____

Address _____

City _____ State _____ Zip _____

Phone _____ Fax _____



Name _____ Type of business _____

Address _____

City _____ State _____ Zip _____

Phone _____ Fax _____



Name _____ Type of business _____

Address _____

City _____ State _____ Zip _____

Phone _____ Fax _____



Bank reference _____

Branch Address _____

City _____ State _____ Zip _____

Branch officer who handles account _____

In consideration of your opening the above account and/or extended credit, the undersigned hereby agrees that all information supplied in this application is correct, that all accounts are to be paid in full to Duff Company monthly by the tenth day of the month following the invoice date, that a 1% service charge and a 1% interest charge will be made on any balance open at the end of the month following invoice date, and that in the event that legal action or lien be taken, or the service of a collection agency are used to collect this account, the undersigned shall pay all expenses incurred by the Duff company, such as, but not limited to, collection fees, costs and legal fees.

Applicant (Name of Account) _____

By _____ Title _____

The undersigned _____ and _____
for good and valuable consideration, hereby jointly, severally and personally unconditionally guarantee, warrant and promise the full and prompt (within terms) payments of all bills and other obligations (as set forth above) of the applicate in connection with any credit extended to the applicant by Duff Company.*

Principal _____ Witness _____ Principal's Spouse _____ Witness _____

Principal _____ Witness _____ Principal's Spouse _____ Witness _____

We routinely fax invoices to our customers. Please provide a fax number where we can send invoices _____

PLEASE FAX FORM TO 610-275-6761

*As appropriate, we may also require the guarantee of a principal and, in some cases, the principal's spouse.

For Duff Company Use Only			
Credit Limit: _____	Contact: _____	Certificate Recd: _____	
Tax Jurisdiction: _____	General Manager: _____	Type: _____	
Salesman: _____	Class: _____	Controller: _____	
	Date Approved: _____		